

EL LIDER EN TECNOLOGÍA
THE LEADER IN TECHNOLOGY

EL LIDER EN CALIDAD
THE LEADER IN QUALITY

**EL LIDER EN COMPROMISO
MEDIOAMBIENTAL**
THE LEADER IN THE
COMMITMENT TO THE
ENVIRONMENT

EL LIDER EN SERVICIO
THE LEADER IN SERVICE

**ABRIENDO MILLONES DE PUERTAS
EN TODO EL MUNDO CADA DÍA**

*GLOBALLY UNLOCKING
MILLIONS OF DOORS DAILY*

SUMARIO

CONTENTS

A6-A20	JMA, LA LLAVE DE LA EXCELENCIA JMA, BIKAINTASUNAREN GILTZA JMA, THE KEY TO EXCELLENCE JMA, LA CLÉ DE L'EXCELLENCE JMA, DER SCHLÜSSEL ZUR EXZELLENZ
A6-A7	JMA es Compromiso JMA Konpromisoa da JMA is Commitment JMA, l'engagement JMA bedeutet Verpflichtung
A8-A9	JMA, el Líder JMA Liderra JMA the Leader JMA, le Leader JMA der Marktführer
A10-A11	JMA en el Mundo JMA Munduan JMA Worldwide JMA dans le Monde JMA in der Welt
A12-A15	Tipos de Llaves Giltza Motak Key Types Types de Clés Schlüsseltypen
A16-A17	Descripción y Terminología Deskribapen eta Terminologia Description and Terminology Description et Terminologie Begriffserklärung und Terminologie
A18-A19	Símbolos y Nacionalidades Ikur eta Nazionalitateak Symbols and Nationalities Symboles et Nationalités Symbole und Nationalitäten
A21-A61	ÍNDICES AURKIBIDEAK CONTENTS TABLES DES MATIÈRES INHALT
A21-A46	Índice General Aurkibide Orokorra General Index Index Generale Gesamtverzeichnis
A47-A61	Índice de Marcas Marken Aurkibidea Brand Index Index Marque Hauptmarke
01-395	TIPOS DE LLAVES GILTZA MOTAK TYPES OF KEYS TYPES DE CLÉS SCHLÜSSELTYPEN
01-141	Llaves Planas para Cerraduras de Cilindro Sarraila Zilindrikotarako Giltza Zapalak Cylinder Keys Clés pour Cylindres Zylinderschlüssel
142-221	Llaves para Vehículos Ibilgailuentzako Giltzak Keys for Vehicles Clés pour Véhicules Fahrzeugschlüssel
222-224	Llaves de Cierre Ixteko Giltzak Snap-lock Keys Clés de Bouche d'eau Dornschlüssel

225-235	Llaves en Cruz Gurutze-Giltzak Cruciform Keys Clés Cruciformes Kreuzschlüssel
236-256	Llaves de Gorja Acero Dulce Altzairu Gozozko Gorja-Giltzak Mild Steel Bit Keys Clés à Gorges en Acier Doux Chubbsschlüssel aus Weichstahl
257-315	Llaves de Gorja Latón Letoizko Gorja Giltzak Brass Bit Keys Clés à Gorges en Laiton Chubbsschlüssel aus Messing
316-317	Llaves de Gorja Zamak Zamakezko Gorja Giltzak Zamak Bit Keys Clés à Gorges en Zamak Chubbsschlüssel aus Zamak
318-322	Llaves Artísticas y de Armario Latón Letoizko Giltzak: Armairuetarako eta Artistikoak Brass Furniture Keys Clés pour Meubles en Laiton Möbelschlüssel aus Messing
323-324	Llaves Artísticas y de Armario Zamak Zamakezko Giltzak: Armairuetarako eta Artistikoak Zamak Furniture Keys Clés pour Meubles en Zamak Möbelschlüssel aus Zamak
325-326	Llaves para Casillas y Ascensores Kutxatila eta Iggogailuentzako Giltzak Lift and Mail Box Keys Clés pour Ascenseurs et Boîtes à Lettres Briefkasten-und Liftsschlüssel
327-395	GUIA DE MARCAS MARKEN GIDA MAIN GUIDE GUIDE DES MARQUES MARKENINDEX
327-364	Automovil-Camioneta Automobila-Kamioneta Car-Pick up Voiture-Camionnette Auto-Kleintransporter
365-372	Camión Kamioia Trucks Camion Lkw
373-390	Motocicleta Motozikleta Motorcycle Motocyclette Motorrad
391-395	Alarma - avión - bicicleta - caravana - tapón de gasolina - motor marino - portaesquí - tractor - excavadora - carretilla elevadora - corta cesped Alarma - Hegazkina - Bizikleta - Karabana - Gasolina Tapoia - Itsas Motorra - Eskieuskarria - Traktorea - Hondeatzaila - Orga Jasotzaila - Belarra Mozteko Makina Alarm - Airplan - Bicycle - Caravans - Petrol Cap - Boat Engines - Ski Holder - Tractor - Earth Moving Machine - Forklift - Lawn Mower Alarme - Avion - Bicyclette - Caravane - Bouchon Reservoir - Moteur de Bateau - Porte Ski - Traktor - Machine por Déplacement de Terre - Clark - Tondeuse Alarm - Flugzeuge - Fahrräder - Wohnwagen - Tankverschlüsse - Schiffsmotoren - Skiträger Landmaschinen - Baumaschinen - Gabelstapler - Rasenmäher

ESPAÑOL

CATÁLOGO GENERAL C.10

Las llaves que aparecen en este catálogo son piezas JMA fabricadas por Alejandro ALTUNA S.A. o un sub-contratista de éste. Están diseñadas para cilindros y cerraduras de los fabricantes cuyas marcas se indican en este catálogo.

Conforme a las disposiciones legales vigentes relativas a la propiedad industrial, las marcas o nombres comerciales indicados en este catálogo son propiedad exclusiva de los fabricantes de cilindros y cerraduras, así como de los fabricantes de automóviles, otros constructores, distribuidores y usuarios.

Dichas marcas o nombres comerciales se indican en calidad simplemente informativa con el fin de reco-

nocer con rapidez la cerradura a la que corresponden nuestras piezas.

Este catálogo está reservado exclusivamente a profesionales de la reproducción de llaves que utilizan piezas JMA.

Los datos referentes a los productos de este catálogo tienen carácter indicativo. Manteniendo siempre las características básicas, nos reservamos el derecho de realizar, sin previo aviso, modificaciones técnicas, estéticas o de otro tipo, por razones de evolución de los productos en cuestión.

Algunos modelos que están en este nuevo catálogo podrán recibirlos tanto con la marca y la referencia JMA como con otra marca del grupo ALTUNA.

EUSKERA

KATALOGO OROKORRA C.10

Katalogo honetan ageri diren giltzak Alejandro ALTUNA SA enpresak edo honek kontratatutako beste enpresa batek egindako JMA piezak dira. Katalogoan zehazten diren marken fabrikatzaileen zilindro eta sarrailetarako diseinatuta daude.

Jabetza industrialari buruz indarrean dauden lege-xedapenekin bat etorritik, katalogo honetan zehaztutako merkataritza-markak edo izenak zilindro eta sarraileen fabrikatzaileen nahiz ibilgailuen fabrikatzaileen eta beste eraikitzaile, banatzaile eta erabiltzaile batzuen jabetza eskusibokoak dira.

Merkataritza-marka edo izen horiek zehaztasun gehiago emateko adierazten dira, gure piezak zein sarraileri dagozkion berehala ikusi ahal izateko.

Katalogo hau giltzen kopiak egiteko JMA piezak erabiltzen dituzten profesionalentzako da soilik.

Katalogo honetako produktuei buruzko datuek izaera adierazgarria dute. Oinarrizko ezaugarriak gordez, produktuen bilakaeraren ondoriozko aldaketa teknikoak, estetikoak edo bestelakoak egiteko eskubidea dugu, aurretik horren berri eman beharrik gabe.

Katalogo berri honetan dauden eredueta batak JMA marka eta erreferentziarekin nahiz ALTUNA taldeko beste marka batekin jaso ahal izango dira.

ENGLISH

GENERAL CATALOGUE C.10

The keys that appear in this catalogue are JMA parts manufactured by Alejandro ALTUNA S.A. or one of its subcontractors. They are designed for cylinders and locks made by the manufacturers whose trademarks are indicated in this catalogue.

In accordance with legal requirements relating to industrial property rights, the trademarks or trade names indicated in this catalogue are the exclusive property of the manufacturers of the cylinders and locks, as well as automobile manufacturers, other constructors, distributors and users.

The aforementioned trademarks or trade names are indicated simply for information purposes so that the lock to which our parts correspond can be recognised quickly and easily. This catalogue is for the exclusive use of professional key copiers who use JMA parts.

Data referring to the products in this catalogue are indicative in nature. Although the basic characteristics are maintained at all times, we reserve the right to make, without previous notice, any technical, aesthetic or other types of changes involved in the development of the products in question. Some of the keys in this new catalogue could be received either with the JMA reference and trademark or with another trademark from the ALTUNA group.

FRANÇAIS

CATALOGUE GENERALE C.10

Les ébauches de clés reportées sur ce catalogue sont des ébauches JMA fabriquées par Alejandro ALTUNA S.A. ou un de ses sous-traitants. Elles sont destinées aux cylindres et serrures des fabricants dont les marques sont indiquées dans ce catalogue.

Conformément aux dispositions légales en vigueur relatives à la propriété industrielle, les marques ou les dénominations commerciales citées dans ce catalogue sont la propriété exclusive des fabricants de cylindres et de serrures ainsi que des constructeurs de voitures, autres constructeurs, distributeurs et utilisateurs.

Ces marques ou dénominations commerciales sont indiquées à titre de simple information afin de connaître rapidement à quelle serrure nos ébauches sont destinées.

Ce catalogue est exclusivement réservé aux professionnels de la reproduction de clés, utilisant des ébauches JMA.

Les renseignements sur les produits de ce catalogue sont donnés à titre indicatif. Tout en gardant les caractéristiques de base, nous nous réservons le droit d'apporter, sans préavis, des modifications techniques, esthétiques ou autres, dues à l'évolution des produits en question.

Des ébauches de, cet catalogue pourront être livrées soit avec la marque et référence JMA soit avec une autre marque du groupe ALTUNA.

DEUTSCH

GESAMTKATALOG C.10

Die in dem vorliegenden Katalog aufgeführten Schlüssel sind JMA-Teile, die von der Firma Alejandro ALTUNA, S.A., einem Zulieferanten von JMA, hergestellt werden. Sie sind für Zylinder und Schlösser derjenigen Hersteller entwickelt worden, deren Marken in diesem Katalog aufgeführt sind.

In Übereinstimmung mit den geltenden gesetzlichen Vorschriften bezüglich des gewerblichen Eigentums sind die im vorliegenden Katalog aufgeführten Marken und Firmennamen ausschließliches Eigentum der Zylinder- und Schloßhersteller, sowie der Automobilhersteller und anderer Konstrukteure, Vertreter und Benutzer.

Diese Marken und Firmennamen werden nur zu Informationszwecken aufgeführt, mit dem Ziel, auf schnelle Weise zu erkennen, zu welchem Schloß unsere Teile gehören.

Dieser Katalog ist ausschließlich für Fachleute des Bereichs der Schlüsselreproduktion gedacht, die JMA-Teile verwenden.

Die Daten bezüglich der Produkte des vorliegenden Katalogs haben informativen Charakter. Bei Aufrechterhaltung der grundlegenden Eigenschaften behalten wir uns das Recht vor, aus Gründen der Entwicklung der entsprechenden Produkte und ohne Vorankündigung technische, ästhetische oder andere Änderungen vorzunehmen. Einige Modelle des neuen Katalogs können Sie sowohl mit der Marke und der Bezeichnung JMA erhalten, als auch mit jeder anderen Marke der Gruppe ALTUNA.

CATÁLOGO GENERAL C.10

GENERAL CATALOGUE C.10

THE KEY TO EXCELLENCE
GLOBALLY UNLOCKING MILLIONS OF DOORS DAILY



ESPAÑOL

NUESTRO ÉXITO ESTÁ BASADO EN EL COMPROMISO DE LAS PERSONAS

Alejandro Altuna S.A. es la sociedad matriz e impulsora de Altuna Group. Fabrica todo tipo de **llaves para cerradura** así como **máquinas duplicadoras**. Sus productos van destinados al mercado **OEM** y a la reposición, en este caso con la marca **JMA**.

Fundada por el Sr. Alejandro Altuna en 1942 arrancó su actividad en Mondragón. En poco tiempo, una nueva generación familiar que apostó por el desarrollo y la inversión impulsó a la empresa a un importante crecimiento que consolidó a la marca **JMA** hacia los 60 como líder indiscutible del país.

Posteriormente, la estrategia de apertura de mercados exteriores apoyada en la internacionalización y siempre basada en un enfoque innovador de los procesos industriales, ha convertido a **ALTUNA GROUP** en el **primer productor de llaves europeo y referente mundial** en este campo.

Actualmente, 13 compañías en 4 continentes trabajan conjuntamente para el desarrollo y potenciación de la fuerza de nuestra marca JMA, conocida en más de 100 países en todo el mundo.

JMA integra equipos de **personas comprometidas** y motivadas por un proyecto común que nos ha permitido ser el mayor fabricante de llaves de Europa.

EUSKERA

GURE ARRAKASTA PERTSONEN KONPROMISOAN DATZA

Alejandro Altuna S.A. Altuna Groupen sozietate matrizea eta sustatzaillea da. **Sarrailarako era guztietako giltzak** eta **kopiak egiteko makinak** ekoizten ditu. Bere produktuek **OEM** merkatura eta birjarpena dute helburu, eta, kasu horretan, **JMA** markaz merkaturatzen dira.

Enpresa Alejandro Altuna jaunak sortu zuen 1942an, eta Arrasaten hasi zen lanean. Handik gutxira, familiako belaunaldi berriak garapenaren zein inbertsioaren alde egin zuen, eta enpresa bera ikaragarri hazi zen. Hori dela eta, 60ko hamarkadan, **JMA** marka herrialdeko lider eztabaidaezina zen.

Ondoren, kanpoko merkatuetara irekitzeko estrategia nazioarteko bihurtzeko prozesuan oinarritu da, eta, beti-beti, industria-prozesuen ikuspegi berritzailea hartu du kontuan. Horren ondorioz, **ALTUNA GROUP lehen giltzagilea da Europan**, baita arlo horretako **munduko erreferentea** ere.

Gaur egun, 13 konpainiak 4 kontinentetan lan egiten dute elkarrekin, mundu zabaleko 100etik gora herrialdetan ezaguna den **JMA** markaren indarra garatzeko eta sustatzeko.

JMAko taldeetan **persona konprometitua** eta motibatua daude, eta proiektu bateratua dute. Horri esker, Europako enpresa giltzagile handiena da.

ENGLISH

OUR SUCCESS IS BASED ON OUR PEOPLE'S COMMITMENT

Alejandro Altuna S.A. is the parent company and driving force behind the Altuna Group. It manufactures all types of **lock-keys and key-cutting machines**. Its products are for the **OEM** and replacement markets, in the latter case with the **JMA** brand.

Set up by Alejandro Altuna in 1942, it started the production in Mondragón (Spain). In a short time, a new generation of the family committed to development and investment saw the company through significant growth which consolidated the **JMA** brand in the 60's as the indisputable leader in Spain.

Later, the strategy of opening up to foreign markets backed by globalisation and always based on an innovative attitude towards industrial processes, turned the **ALTUNA GROUP** into the **largest producer of keys in Europe and a benchmark worldwide** in the field.

Currently 13 companies in four continents work together to develop the strength of our **JMA** brand, well known in more than 100 countries all over the world.

This successful trail has lead us to become the biggest key producer in Europe based on **our people's commitment**.

JMA ES COMPROMISO

JMA IS COMMITMENT



FRANÇAIS

NOTRE SUCCÈS EST FONDÉ SUR L'ENGAGEMENT DES PERSONNES

Alejandro Altuna S.A. est la société-mère qui a donné lieu au Groupe Altuna. Elle fabrique toutes sortes de **clés de serrure et de machines à copier**. Ses produits sont destinés au marché **OEM** et au remplacement, dans ce cas sous la marque **JMA**.

Alejandro Altuna en 1942, elle s'est établie à Mondragón. Très vite, une nouvelle génération familiale a misé sur le développement et grâce aux investissements engagés, l'entreprise a connu une forte croissance qui, dans les années 60, a imposé la marque **JMA** à la tête du secteur.

Par la suite, la stratégie d'ouverture sur les marchés extérieurs et une volonté d'internationalisation toujours sous-tendue par le recours aux procédés industriels les plus novateurs, a fait du **GROUPE ALTUNA** le **premier producteur de clés européenne** et un **réfèrent mondial** dans ce domaine.

Actuellement, 13 firmes sur 4 continents unissent leurs forces pour dynamiser et faire progresser notre marque JMA, connue dans plus de 100 pays du monde entier.

Les équipes JMA sont formées de **personnes motivées et pleinement investies** dans un projet commun qui nous a permis de devenir le plus important fabricant de clés d'Europe.

DEUTSCH

UNSER ERFOLG BASIERT AUF DAS ENGAGEMENT VON MENSCHEN

Alejandro Altuna S.A. ist die Muttergesellschaft, aus der später die Altuna Group hervorging. Sie stellt **Schlüssel** aller Art sowie **Schlüsselkopiermaschinen** her. Ihre Produkte wenden sich an dem OEM- und den Ersatzschlüsselmarkt, in diesem Fall mit der Markenbezeichnung **JMA**.

Das Unternehmen wurde 1942 von Alejandro Altuna gegründet und begann seinen Werdegang in Mondragón. Innerhalb eines nur kurzen Zeitraums sorgte eine neue, auf Entwicklung und Investition setzende Familiengeneration für ein bedeutendes Wachstum und sicherte der Marke **JMA** damit Anfang der 60er Jahre die unbestreitbare Führungsposition im Land.

Später dann hat die auf das Konzept der Internationalisierung und der Innovation der industriellen Prozesse gestützte Strategie der Öffnung gegenüber ausländischen Märkten die **ALTUNA GROUP** zum **führenden europäischen Hersteller von Schlüsseln und einem weltweiten Bezugspunkt** für diesen Sektor werden lassen.

Derzeit arbeiten 13 Unternehmen in 4 Kontinenten gemeinsam, um die Stärke der in über 100 Ländern der ganzen Welt bekannten Marke JMA zu potenzieren und weiterzuentwickeln.

JMA arbeitet mit Teams **engagierter und motivierter Menschen**, die sich für ein gemeinsames Projekt einsetzen, das es uns möglich gemacht hat, der größte Hersteller von Schlüsseln in Europa zu werden.

THE KEY TO EXCELLENCE
GLOBALLY UNLOCKING MILLIONS OF DOORS DAILY

ESPAÑOL:

LIDER EN TECNOLOGÍA:

Una apuesta sólida por la calidad y la innovación basada en la automatización y garantía de procesos y soportada por una vocación inversora a largo plazo.

LIDER EN CALIDAD:

En el ámbito de la Calidad Alejandro Altuna S.A. siempre ha sido una empresa líder y pionera en su sector. Nuestra política de calidad se basa en la prevención y planificación, mejora continua, satisfacción del cliente y participación de las personas

Estos valores están impregnados en nuestra empresa desde sus orígenes y han sido, junto con una adecuada política de inversión en instalaciones y maquinaria, el motivo principal de nuestro éxito, que además nos permite asegurar la competitividad de la empresa y con ello el futuro a largo plazo.

Además de la Certificación en Calidad de acuerdo a la ISO 9001, Alejandro Altuna S.A. acoge Sistemas de Gestión de la Calidad homologados por las empresas líderes del sector de automoción y residencial. Actualmente nuestra empresa es reconocida en el mercado como líder en este campo.

LIDER EN EL COMPROMISO POR EL MEDIO AMBIENTE:

En Alejandro Altuna S.A. las buenas prácticas medioambientales son la norma y no la excepción. Nuestro equipo forma parte de un proyecto de empresa respetuoso con el medioambiente y que colabora con el desarrollo sostenible de nuestro entorno.

Alejandro Altuna S.A. fue el primer fabricante mundial de llaves en conseguir en 2000 el certificado ISO 14001 para su Sistema de Gestión. Este Sistema incorpora la política medioambiental, donde se recogen los valores y compromisos de la empresa, así como procedimientos que desarrollan los sistemas de trabajo y garantizan las correctas prácticas medioambientales en todos los ámbitos de la empresa.

LIDER EN SERVICIO:

La realidad de una empresa se demuestra en su capacidad por responder con la máxima celeridad y eficacia a las necesidades y exigencias de los clientes. Se encuentran donde se encuentren. JMA pone a su disposición 5 plantas productivas en localizaciones estratégicas. Además, gracias a su amplia red de filiales y empresas distribuidoras repartidas por todo el mundo, le permite llegar a cualquier cliente, se cual sea su ubicación.



EUSKERA:

LIDERRA TEKNOLOGIAN:

Kalitatearen eta berrikuntzaren aldeko apustua sendoa da, prozesuen automatizazioan nahiz bermean oinarrituta eta epe luzerako inbertsioa eginda.

LIDERRA KALITATEAN:

Kalitatearen arloan, Alejandro Altuna S.A. sektoreko enpresa liderra eta aitzindaria izan da beti. Hona hemen gure kalitate-politikaren oinarriak: prebentzioa, plangintza, etengabeko hobekuntza, bezeroaren poztasuna eta pertsonen partaidetza.

Balio horiek hasiera-hasieratik ezarri dira gure enpresan, eta, instalazio zein makinatan inbertitzeko politika egokiarekin batera, gure arrakastaren arrazoi nagusia izan dira. Horrez gain, enpresaren lehiakortasuna eta epe luzerako etorkizuna bermatzeko aukera ere eskaini digute.

ISO 9001en arabeko kalitate-ziurtagiria ez ezik, Alejandro Altuna S.A. enpresak ibilgailu-industriako eta bizileku-sektoreko enpresa liderrek homologatutako kalitate-kudeaketarako sistemak ere baditugu. Gaur egun, merkatuaren arabera, gure enpresa liderra da arlo horretan.

LIDERRA INGURUMENAREKIKO KONPROMISOAN:

Alejandro Altuna S.A. enpresan, ingurumen-arloko jarduera egokiak ez dira salbuespena, araua baizik. Gure taldea ingurumena errespetatu eta ingurunearen garapen iraunkorra sustatzen duen enpresa-proiektuaren barruan dago.

2000. urtean, Alejandro Altuna S.A. bere kudeaketa-sistemarako ISO 14001 ziurtagiria lortu zuen lehen giltzagilea izan zen munduan. Ingurumen-politika sistema horren barruan dago kokatuta, eta, bertan, enpresaren balioak zein konpromisoak azaltzen dira, baita lan-sistemak garatu eta enpresako arlo guztietan ingurumen-jarduera egokiak bermatzeko prozedurak ere.

LIDERRA ZERBITZUAN:

Edonon daudela ere, bezeroen premiei eta eskakizunei ahalik eta azkarren eta era eraginkorrean erantzuteko daukan gaitasuna da enpresaren errealitatearen adierazgarri.

JMAk 5 ekoizpen-lantegi ditu leku estrategikoetan. Gainera, bere filialen sarea zabalaz denez eta banaketa-enpresak mundu zabalean barreiatuta daudenez, edozein bezerorengana heldu daiteke, edonon dagoela ere.

JMA, EL LIDER

JMA, THE LEADER

ENGLISH:

THE LEADER IN TECHNOLOGY:

Looking for the latest developments to improve the production processes together with a strong investment policy in all our plants to ensure the company's competitiveness and long-term future.

THE LEADER IN QUALITY:

As far as Quality is concerned, Alejandro Altuna S.A. has always been a leading, pioneering company in its sector. Our quality policy is based on prevention and planning, continuous improvement, customer satisfaction and people participation.

These values have been impregnated in our company from the start and have been, together with a good investment policy in terms of equipment and machinery, the main reason behind our success, which moreover enables us to ensure the company's competitiveness and long-term future.

In addition to Quality Certification to ISO 9001, Alejandro Altuna S.A. operates Quality Management Systems approved by the leading companies in the automotive and residential sectors. Our company is currently recognised in the market as a leader in this field.

THE LEADER IN THE COMMITMENT TO THE ENVIRONMENT:

At Alejandro Altuna S.A. best environmental practice is the norm and not the exception. Our team is part of a business project that respects the environment and contributes to the sustainable development of our community.

Alejandro Altuna S.A. was the first key manufacturer in the world to achieve ISO 14001 certification for its management system in 2000. This system incorporates the environmental policy, which includes the company's values and commitments, as well as procedures to set out the work systems and ensure good environmental practice throughout the company.

THE LEADER IN SERVICE:

The efficiency of a company is shown in its capacity to respond with the maximum speed and effectiveness to the needs and requirements of its customers, wherever they are based.

JMA places at your disposal 5 production plants based in strategic locations. Moreover, with its extensive network of associate and distribution companies located throughout the world, the company can reach any customer, wherever based.

FRANÇAIS:

LEADER EN TECHNOLOGIE:

Un pari résolu sur la qualité et l'innovation basée sur l'automatisation et la garantie des process et soutenu par une vocation d'investissement à long terme.

LEADER EN QUALITÉ:

Dans le domaine de la Qualité, Alejandro Altuna S.A. a toujours été une entreprise pionnière et leader de son secteur. Notre politique de qualité est assise sur la prévention et planification, l'amélioration continue, la satisfaction du client et la participation des personnes. Ces valeurs irriguent notre entreprise depuis sa création. Soutenues par une politique constante d'investissement en installations et machines, elles expliquent, notre succès et, de plus, nous permettent d'assurer la compétitivité de l'entreprise et donc notre futur à long terme.

Bénéficiant de la Certification de Qualité selon la norme ISO 9001, Alejandro Altuna S.A. s'appuie sur des systèmes de gestion de la qualité homologués par les principaux constructeurs, aussi bien automobiles que du bâtiment. Aujourd'hui, notre entreprise est reconnue par le marché comme le leader du secteur.

LEADER EN ENGAGEMENT ENVIRONNEMENTAL:

Pour Alejandro Altuna S.A., les bonnes pratiques environnementales sont la règle et non l'exception. Notre équipe fait partie d'un projet entrepreneurial respectueux de l'environnement qui collabore au développement durable de notre milieu.

Alejandro Altuna S.A. a été le premier fabricant mondial de clés à obtenir, dès 2000, le certificat ISO 14001 pour son système de gestion. Ce système comporte deux piliers: la politique environnementale, où sont définis les valeurs et les engagements de l'entreprise, et les procédures qui développent les systèmes de travail et qui garantissent les bonnes pratiques environnementales dans tous les domaines d'activité.

LEADER EN SERVICE:

La réalité d'une entreprise se démontre par sa capacité à répondre le plus promptement et le plus efficacement possible aux besoins et aux exigences des clients. Où qu'ils se trouvent.

JMA place à leur disposition 5 sites de production situés dans des lieux stratégiquement choisis. De plus, grâce à notre vaste réseau de filiales et de distributeurs répartis dans le monde entier, nous pouvons toucher tous nos clients, où qu'ils soient.

DEUTSCH:

FÜHREND IN TECHNOLOGIE:

Ein solider Einsatz für die Qualität und die Innovation, der sich auf Automatisierung und Prozesssicherheit sowie eine langfristige Investitionsgrundlage stützt.

FÜHREND IN QUALITÄT:

Auf dem Gebiet der Qualität war Alejandro Altuna S.A. stets ein führendes und bahnbrechendes Unternehmen des Sektors. Unsere Qualitätspolitik basiert auf Prävention und Planung, ständiger Verbesserung, Kundenzufriedenheit und Einbeziehung der Mitarbeiter.

Diese Werte sind schon seit den Anfängen fester Bestandteile unseres Unternehmens. Gemeinsam mit einer angemessenen Politik der Investition in Anlagen und Maschinenpark waren sie der wichtigste Grund für unseren Erfolg und sichern darüber hinaus die Wettbewerbsfähigkeit des Unternehmens und damit seine langfristige Zukunft.

Neben der Qualitätszertifizierung nach ISO 9001 verfügt Alejandro Altuna S.A. über Qualitätsmanagementsysteme, die von den führenden Automobil- und Wohnungsbauunternehmen zugelassen sind. Derzeit ist unser Unternehmen auf dem Markt für seine führende Position im Bereich Qualität bekannt.

FÜHREND IM UMWELTSCHUTZ:

Bei Alejandro Altuna S.A. sind gute Umweltpraktiken die Regel, nicht die Ausnahme. Unsere Mitarbeiter sind Teil des Projekts des umweltfreundlichen Unternehmens, das sich für die nachhaltige Entwicklung unserer Umwelt einsetzt. Alejandro Altuna S.A. erhielt im Jahr 2000 als weltweit erster Hersteller von Schlüsseln das Zertifikat ISO 14001 für sein Managementsystem. Dieses System umfasst die Umweltpolitik, die die Werte und Verpflichtungen des Unternehmens sowie die Verfahren für die Herstellungssysteme festlegt, und die korrekten Umweltpraktiken in allen Unternehmensbereichen garantiert.

FÜHREND IM SERVICE:

Die Realität eines Unternehmens zeigt sich in seiner Fähigkeit, in optimalem Zeitrahmen und mit maximaler Effizienz auf die Bedürfnisse und Anforderungen der Kunden zu reagieren, unabhängig davon, wo diese sich befinden. JMA verfügt über 5 Fertigungsstätten an strategischen Standorten. Dank eines über die ganze Welt ausgedehnten Netzes von Filialen und Vertriebshändlern ist das Unternehmen immer in der Nähe seiner Kunden, egal wo.

**13 COMPAÑÍAS EN 13 PAÍSES
400 PERSONAS Y
MÁS DE 450 MILLONES DE LLAVES AL AÑO
EN MÁS DE 100 PAÍSES EN TODO EL MUNDO.**

**El potencial de JMA en el mundo está cimentado a través de sus plantas productivas y filiales comerciales en Europa, América del Norte y del Sur, Asia y África.
La internacionalización es una estrategia prioritaria en JMA.**

JMA MUNDUAN

13 konpainia 13 herrialdeetan; 400 pertsona eta 450 milioitik gora giltza urtean, mundu zabaleko 100etik gora herrialdeetan.

*JMA enpresak ahalmena du munduan, ekoizpen-lantegiak eta filial komertzialak dituelako Europan, Ipar Amerikan, Hego Amerikan, Asian eta Afrikan.
Izan ere, nazioarteko bihurtzea lehentasunezko estrategia da JMArentzat.*

JMA WORLDWIDE

13 companies in 13 countries; 400 people and over 450 million keys sold in more than 100 countries all over the 5 continents

*JMA's potential worldwide is based on its production plants and commercial subsidiaries in Europe, North and South America, Asia and Africa.
Globalisation is a priority strategy for JMA.*

JMA DANS LE MONDE

13 sociétés dans 13 pays ; 400 personnes et plus de 450 millions de clés vendues chaque année dans plus de 100 pays de quatre continents

*Le potentiel de JMA dans le monde est solidement ancré dans un réseau de production et de distribution qui couvre l'Europe, les deux Amériques, l'Asie et l'Afrique.
L'internationalisation est une stratégie prioritaire pour JMA.*

JMA IN DER WELT

13 Unternehmen in 13 Ländern; 400 Personen und über 450 Millionen Schlüssel pro Jahr in über 100 Ländern der ganzen Welt.

Das Leistungspotenzial von JMA in der ganzen Welt wird durch seine Produktionsstätten und Handelsfilialen in Europa, Nord- und Südamerika, Asien und Afrika konsolidiert. Internationalisierung ist eine vorrangige Strategie von JMA.



● **PLANTAS PRODUCTIVAS**
MANUFACTURING PLANTS

● **CENTROS DE DISTRIBUCIÓN**
DISTRIBUTION CENTERS

JMA EN EL MUNDO

JMA WORLDWIDE

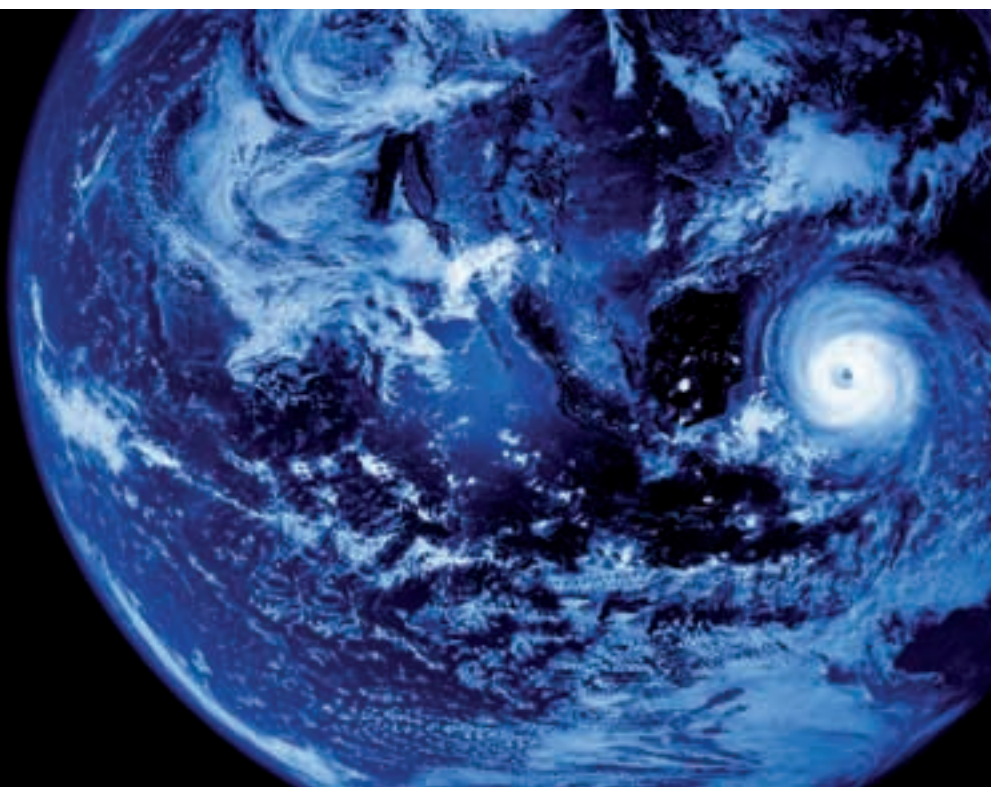

THE KEY TO EXCELLENCE
GLOBALLY UNLOCKING MILLIONS OF DOORS DAILY

01-141

LLAVES PLANAS PARA CERRADURAS DE CILINDRO

SARRAILA ZILINDRIKOTA-
RAKO GILTZA ZAPALAK

CYLINDER KEYS

CLÉS POUR CYLINDRES

ZYLINDERSCHLÜSSEL



142-221

LLAVES PARA VEHÍCULOS

IBILGAILUENTZAKO
GILTZAK

KEYS FOR VEHICLES

CLÉS POUR VÉHICULES

FAHRZEUGSCHLÜSSEL



222-224

LLAVES DE CIERRE

IXTEKO GILTZAK

SNAP-LOCK KEYS

CLÉS DE BOUCHE D'EAU

DORNSCHLÜSSEL



225-235

LLAVES EN CRUZ

GURUTZE-GILTZAK

CRUCIFORM KEYS

CLÉS CRUCIFORMES

KREUZSCHLÜSSEL



236-256

LLAVES DE GORJA ACERO DULCE

ALTZAIRU GOZOZKO
GORJA-GILTZAK

MILD STEEL BIT KEYS

CLÉS À GORGES EN ACIER DOUX

CHUBBSCHLÜSSEL
AUS WEICHSTAHL



-  237-242
-  243-246
-  247-252
-  253-256

TIPOS DE LLAVES

KEY TYPES

257-315

LLAVES DE GORJA LATÓN

LETOIZKO GORJA GILTZAK

BRASS BIT KEYS

CLÉS À GORGES EN
LAITON

CHUBBSCHLÜSSEL AUS
MESSING

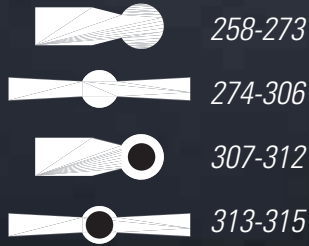

316-317

LLAVES DE GORJA ZAMAK

ZAMAKEZKO GORJA GILTZAK

ZAMAK BIT KEYS

CLÉS À GORGES EN ZAMAK

CHUBBSCHLÜSSEL AUS
ZAMAK



318-322

LLAVES ARTÍSTICAS Y DE ARMARIO LATÓN

LETOIZKO GILTZAK:
ARMAIRUETARAKO
ETA ARTISTIKOAK

BRASS FURNITURE KEYS

CLÉS POUR MEUBLES EN LAITON

MÖBELSCHLÜSSEL
AUS MESSING



323-324

LLAVES ARTÍSTICAS Y DE ARMARIO ZAMAK

ZAMAKEZKO GILTZAK:
ARMAIRUETARAKO
ETA ARTISTIKOAK

ZAMAK FURNITURE KEYS

CLÉS POUR MEUBLES EN ZAMAK

MÖBELSCHLÜSSEL AUS ZAMAK



325-326

LLAVES PARA CASILLAS Y ASCENSORES

KUTXATILA ETA
IGOGAILUENTZAKO GILTZAK

LIFT AND MAIL BOX KEYS

CLÉS POUR ASCENSEURS ET
BOITES A LETTRES

BRIEFKASTEN- UND
LIFTSSCHLÜSSEL



THE KEY TO EXCELLENCE
GLOBALLY UNLOCKING MILLIONS OF DOORS DAILY

GRABADAS

GILTZA GRABATUAK

COINED KEYS

CLÉS FRAPÉES

PRÄGESCHLÜSSEL

*Consultar Referencias
Erreferentziak Kontsultatu
Check References
Voir Références
Referenzen Konsultieren*



ALUMINIO

*Consultar Referencias
Erreferentziak Kontsultatu
Check References
Voir Références
Referenzen prüfen*



COLORMATIC

*Consultar Referencias
Erreferentziak Kontsultatu
Check References
Voir Références
Referenzen prüfen*



LLAVES ESPECIALES

SPECIAL KEYS

FASHION

*Consultar Referencias
Erreferentziak Kontsultatu
Check References
Voir Références
Referenzen prüfen*



PET COLLECTION

*Consultar Referencias
Erreferentziak Kontsultatu
Check References
Voir Références
Referenzen prüfen*



STYLCOLOR

*Consultar Referencias
Erreferentziak Kontsultatu
Check References
Voir Références
Referenzen prüfen*



THE KEY TO EXCELLENCE
GLOBALLY UNLOCKING MILLIONS OF DOORS DAILY

ESPAÑOL

- 1 MARCA PRINCIPAL
- 2 CABEZA
- 3 CUELLO
- 4 TOPE
- 5 PALETÓN
- 6 PUNTA
- 7 UTILIZACIÓN
- 8 NOMENCLATURA DE PERFIL ORIGINAL
- 9 PERFIL IZQUIERDO
- 10 PERFIL DERECHO
- 11 REFERENCIA
- 12 MARCAS SECUNDARIAS
- 13 SERIES
- 14 MARCA PRINCIPAL
- 15 MARCAS SECUNDARIAS DE LA PRINCIPAL (ABSA)

1 ABSA

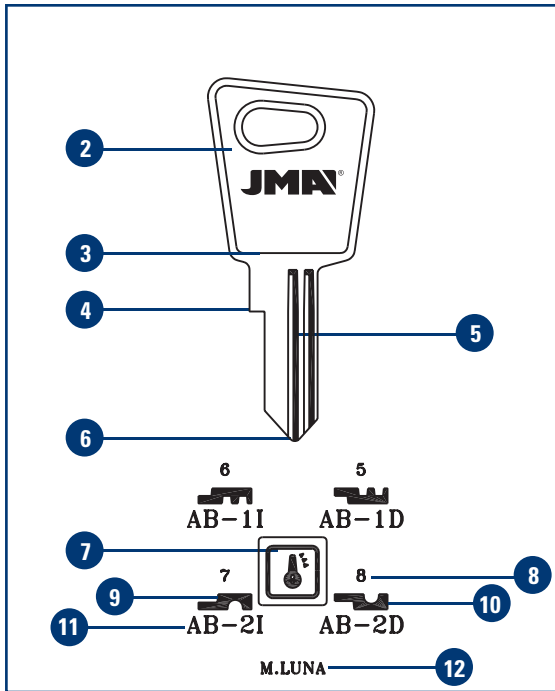

1 VACHETTE

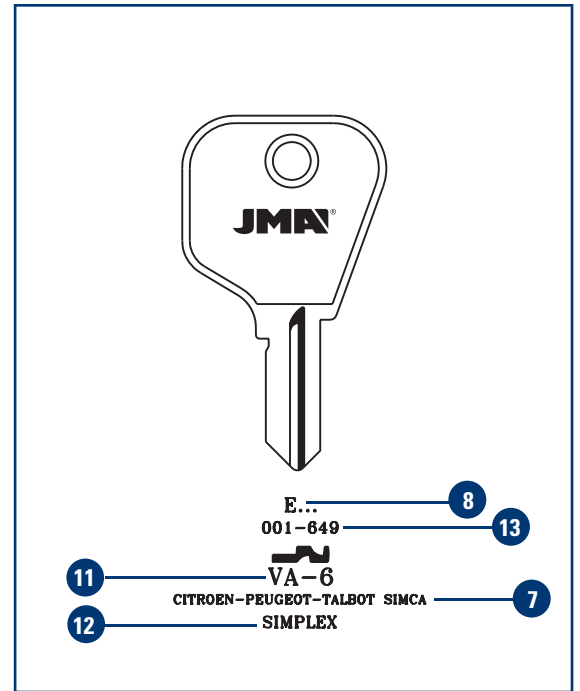

EUSKERA	ENGLISH	FRANÇAIS	DEUTSCH
1 MARKA NAGUSIA	1 MAIN BRAND	1 MARQUE PRINCIPALE	1 HAUPTPRÄGUNG
2 BURUA	2 HEAD	2 TÊTE	2 KOPF
3 LEPOA	3 NECK	3 COU	3 HALS
4 TOPEA	4 SHOULDER	4 ARRÊT	4 ANSCHLAG
5 BELARRIA	5 BLADE	5 CANON	5 SCHAFT
6 PUNTA	6 TIP	6 POINTE	6 SPITZE
7 ERABILERA	7 USE	7 UTILISATION	7 VERWENDUNG
8 JATORRIZKO PROFILAREN IZENDEGIA	8 ORIGINAL PROFILE	8 PROFIL ORIGINAL	8 ORIGINALPROFIL
9 EZKERREKO PROFILA	9 LEFT PROFILE	9 PROFIL GAUCHE	9 LINKSPROFIL
10 ESKUINEKO PROFILA	10 RIGHT PROFILE	10 PROFIL DROIT	10 RECHTSPROFIL
11 ERREFERENTZIA	11 REFERENCE	11 RÉFÉRENCE	11 BEZEICHNUNG
12 BIGARREN MAILAKO MARKAK	12 SECONDARY BRAND	12 MARQUE SECONDAIRE	12 2. PRÄGUNG
13 SERIEAK	13 SERIES	13 CODE	13 SERIE
14 MARCA NAGUSIA ETA JATORRIZKOA	14 MAIN BRAND AND NATIONALITY	14 MARQUE PRINCIPALE ET NATIONALITÉ	14 HAUPTPRÄGUNG UND NATIONALITÄT
15 MARKA NAGUSIAREN BIGARREN MAILAKO MARKAK (ABSA)	15 SECONDARY BRANDS OF THE MAIN ONE (ABSA)	15 MARQUES SECONDAIRES DE LA PRINCIPALE (ABSA)	15 2. PRÄGUNG FÜR HAUPTPRÄGUNG (ABSA)

DESCRIPCIÓN Y TERMINOLOGÍA

KEY DESCRIPTION AND TERMINOLOGY

ESPAÑOL

- 1 CABEZA
- 2 CUELLO
- 3 DIÁMETRO DE LA CAÑA
- 4 CAÑA
- 5 LONGITUD A
- 6 PALETON
- 7 PERFIL MACHO
- 8 REFERENCIA
- 9 MARCA ORIGINAL
- 10 PERFIL HEMBRA

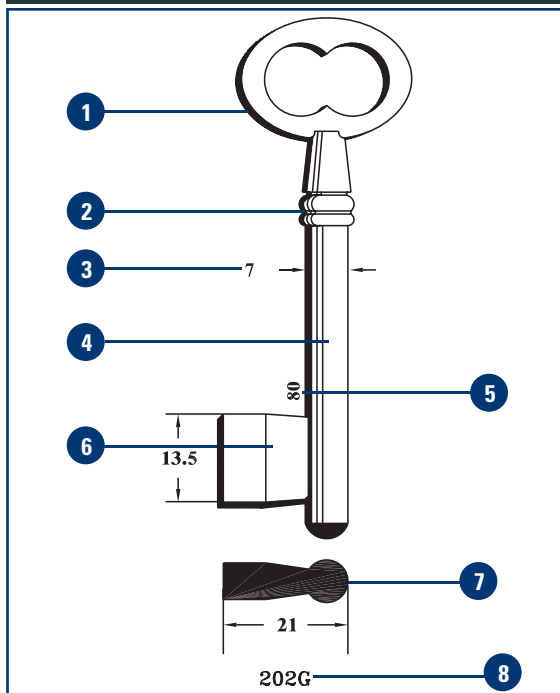

9 — ORENGO

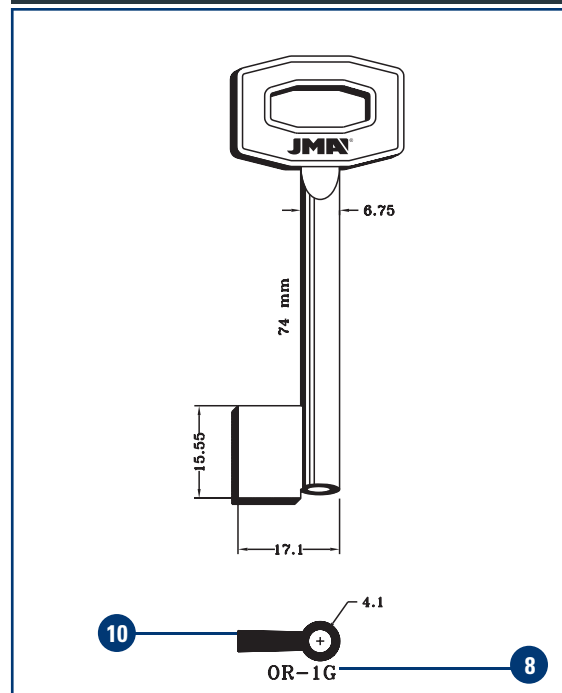

EUSKERA

- 1 BURUA
- 2 LEPOA
- 3 ZIRIAREN
DIAMETROA
- 4 ZIRIA
- 5 A LUZERA
- 6 BELARRIA
- 7 PROFIL ARRA
- 8 ERREFERENTZIA
- 9 JATORRIZKO
MARKA
- 10 PROFIL EMEA

ENGLISH

- 1 HEAD
- 2 NECK
- 3 SHANK
DIAMETER
- 4 SHANK
- 5 LENGTH A
- 6 BIT
- 7 PIN BIT PROFILE
- 8 REFERENCE
- 9 ORIGINAL BRAND
- 10 PIPE BIT PROFILE

FRANÇAIS

- 1 TÊTE
- 2 COU
- 3 DIAMETRE DU
CANON
- 4 CANON
- 5 LONGUEUR A
- 6 PANNETON
- 7 PROFIL MALE
- 8 RÉFÉRENCE
- 9 MARQUE
ORIGINALE
- 10 PROFIL FEMELLE

DEUTSCH

- 1 KOPF
- 2 HALS
- 3 HALM-
DURCHMESSER
- 4 HALM
- 5 LÄNGE A
- 6 BART
- 7 SCHWEIFUNG
- 8 BEZEICHNUNG
- 9 ORIGINAL-
PRÄGUNG
- 10 GEBOHRT

ALP.

Llave fabricada en alpaca

Alpakaz egindako giltza
Key available in nickel silver
Clé fabriquée en maillechort
Schlüssel auch in Neusilber lieferbar

LAT.

Llave disponible también en latón

Giltza, letoizkoa ere eskuragarria
Key also available in brass
Clé aussi disponible en laiton
Schlüssel auch in Messing lieferbar

COL.

Llave disponible también con cabeza de plástico en colores

Giltza hau koloretako plastikozko buruarekin ere eskuragarria

Key also available with coloured plastic head

Clé aussi disponible avec tête plastifiée en couleurs

Schlüssel auch mit farbigem Plastikkopf lieferbar

ALU.

Llave disponible también en aluminio

Giltza, aluminioan ere eskuragarria
Key also available in aluminium
Clé aussi disponible en aluminium
Schlüssel auch in Aluminium lieferbar

ZAM.

Llave fabricada solamente en zamak

Zamakez soilik egindako giltza
Key only available in zamak
Clé aussi disponible en zamak
Schlüssel nur aus Zamak lieferbar



35

Llave de utilizacion en candados

Giltzarrapoetan erabiltzeko giltzak
Key for padlocks
Clé pour cadenas
Schlüssel für Hangschlösser



Llave de utilización en cerraduras auxiliar

Sarraila osagarrietan erabiltzeko giltzak
Key for cam locks
Clé pour petite serrurie
Schlüssel für Hebelschlösser



Llaves para motocicletas

Motozikleta giltzak
Key for motorcycles
Clé pour motocyclettes
Schlüssel für Motorräder



Llave para tapón de gasolina

Gasolina-tapoietarako giltza
Key for fuel cap
Clé pour bouchon d'essence
Schlüssel für Tankdeckel



Llave para camión

Kamioiko giltza
Key for lorries
Clé pour camion
Schlüssel für Lastkraftwagen



Alarma

Alarma
Alarm
Alarme
Alarm



Llaves gorja con acabado en color natural

Gorja giltzak berezko kolorezko akaberarekin
Bit key blank with natural colour finishing
Clé à gorges avec finition en couleur naturel
Chubbsschlüssel in naturfarben Ausführung



Llaves gorja con acabado en negro antiguo

Gorja giltza, beltz zaharkitu akaberarekin
Bit key blank with old black finishing
Clé à gorges avec finition en vieux noir
Chubbsschlüssel in altschwarzer Ausführung

NACIONALIDAD - NAZIONALITATEA - NATIONALITY - NACIONALITÉ - NATIONALITÄT

AUSTRIA
AUSTRALIA
BELGIUM
BRAZIL
CANADA
SWITZERLAND
GERMANY
DENMARK

A
AUS
B
BR
CDN
CH
D
DK

ALGERIA
SPAIN
ESLOVAKIA
EGYPT
FRANCE
GREAT BRITAIN
GREECE
HUNGARY

DZ
E
ES
ET
F
GB
GR
H

HONG KONG
CROATIA
ITALY
ISRAEL
INDIA
EIRE
JAPAN
KOREA

HK
HR
I
IL
IND
IRL
J
K

SÍMBOLOS

SYMBOLS

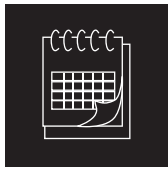

Calendario

Egutegia
Calendar
Calendrier
Kalender



Contacto auto

Autoko kontaktua
Engine ignition
Contact auto
Zündschloss Pkw

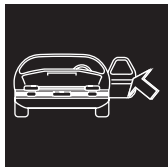

Puerta

Atea
Door lock
Portière
Türe



Maletero/Puerta trasera

Maletategia/Atzeko atea
Boot/Hatchback
Coffre/Portière postérieure
Kofferraum/Hecktür



Tapón de gasolina

Gasolina-tapoia
Petrol cap
Bouchon réservoir
Benzintankverschluss

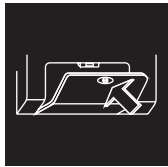

Guantera

Eskularru-kutxa
Drawer
Tiroir
Schublade

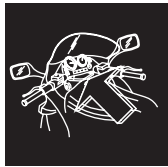

Contacto moto

Moto-kontaktua
Motorbike ignition
Contact moto
Zündschloss Motorrad

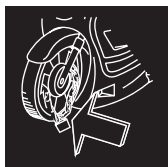

Bloqueo moto

Moto-blokeoa
Motorbike disc lock
Bloquage moto
Bremsenschloss Motorrad



Sillin

Zela
Cycle seat
Selle
Sattel



Casco

Kaskoa
Helmet
Casque
Helm



Automovil / camioneta

Automobila / kamioneta
Car / Pick-up trucks
Voiture / Camionnette
Auto / Kleintransporter

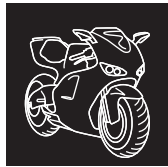

Motocicleta

Motozikleta
Motorcycle
Motocyclette
Motorrad



Camión

Kamioia
Trucks
Camion
Lkw



Avión

Hegazkina
Aeroplane
Avion
Flugzeuge

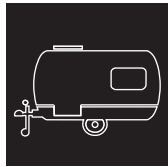

Caravana

Karabana
Caravans
Caravane
Wohnwagen

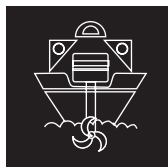

Motor marino

Itsas motorra
Boat engines
Moteur de bateau
Schiffsmotoren



Bicicleta

Bizikleta
Bicycle
Bicyclette
Fahrräder

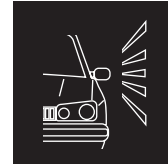

Alarma

Alarma
Alarm
Alarme
Alarm

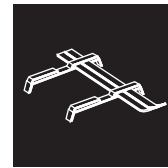

Portaesquis

Eski-euskarria
Ski holder
Porte ski
Skiträger

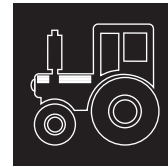

Tractor

Traktorea
Tractor
Traktor
Landmaschinen

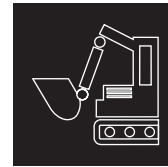

Escavadora

Hondeatzailea
Earth moving machine
Machine déplacement de terre
Baumaschinen



Carretilla elevadora

Orga jasotzailea
Forklift
Clark
Gabelstapler



Corta cesped

Belarra mozteko makina
Lawn-mower
Tondeuse
Rasenmäher



Alarma - llave

Alarma - giltza
Alarm - key
Alarme - clef
Alarm - Schlüssel

KUWAIT
MEXICO
NORWAY
THE NETHERLANDS
PORTUGAL
PERU
POLAND
ARGENTINA

KW
MEX
N
NL
P
PE
PL
RA

TAIWAN
CHILE
CHEKIA
RUMANIA
SWEDEN
FINLAND
SLOVENIA
RUSIA

RC
RCH
RCZ
RU
S
SF
SLO
RJ

CHINA
TUNISIA
UNITED STATES OF AMERICA
YUGOSLAVIA
VENEZUELA
ZAMBIA

TJ
TN
USA
YU
YV
Z

ÍNDICE GENERAL

AURKIBIDE OROKORRA

GENERAL INDEX

INDEX GENERALE

GESAMTVERZEICHNIS



THE KEY TO EXCELLENCE
GLOBALLY UNLOCKING MILLIONS OF DOORS DAILY

LLAVES PARA CERRADURAS A CILINDRO Y VEHÍCULOS

SARRAILA ZILINDRIKO ETA IBILGAILUENTZAKO GILTZAK • KEYS FOR CYLINDERS AND VEHICLES
CLÉS POUR CYLINDRES ET VÉHICULES • SCHLÜSSEL FÜR ZYLINDER UND AUTOSCHLÖSSER

REF.	PAG.	PAG.
5-L	122	
6-C	132	
6-L	132	
7-S	107	
8M- 1D	93	
15-D	204	
15-I	204	
16-D	204	
16-I	204	
26-M	101	
28-D	145	
35-D	132	
35-I	132	
38-D	132	
38-I	132	
41-4/4	190	
45- 1	1	
45- 1D	1	
45- 2	1	
45- 2D	1	
48-D	167	
48-I	167	
303- 1	1	
303- 1D	1	
333- 1D	1	
333- 2D	1	

A

AB- 1D	2	143
AB- 1I	2	143
AB- 1T	2	
AB- 2D	2	143
AB- 2I	2	143
AB- 2T	2	
AB- 3I	2	
AB- 3T	2	
AB- 4D	143	
AB- 4T	2	
AB- 5D	2	143
AB- 5I	2	143
AB- 6D	3	143
AB- 6I	3	143
AB- 7I	143	
AB- 8D	3	143
AB- 8I	3	143
AB- 9D	3	
AB-10I	143	
AB-11	3	
ABA-1	1	
ABC- 1	1	
ABC- 2	1	
ABC- 3D	1	
ABC- 5D	1	

REF.	PAG.	PAG.
ABC- 5I	1	
ABC- 6	1	
ABC- 7	2	
ABL-1	2	
ABL-2	2	
ABL-3	2	
ABL-4	2	
ABL-5	2	
ABL-6	2	
ABU- 1	3	
ABU- 1D	3	
ABU- 2D	3	
ABU- 2I	3	
ABU- 3	3	
ABU- 4D	3	
ABU- 4I	3	
ABU- 5D	3	
ABU- 6D	3	
ABU- 6I	3	
ABU- 7D	3	
ABU- 8D	3	
ABU- 8I	3	
ABU- 9D	3	
ABU- 9I	3	
ABU-10D	3	
ABU-10I	3	
ABU-11	4	
ABU-11D	4	
ABU-12D	3	
ABU-12I	3	
ABU-13	4	
ABU-13D	4	
ABU-14	3	
ABU-15	3	
ABU-15D	3	
ABU-16	4	
ABU-17	4	
ABU-17D	4	
ABU-18DP	4	143
ABU-18P	4	143
ABU-19D	4	143
ABU-19DP	4	143
ABU-19P	4	143
ABU-20	3	
ABU-21	4	
ABU-22D	4	
ABU-23D	4	
ABU-24D	4	
ABU-25D	4	
ABU-26D	4	
ABU-27	5	
ABU-27D	5	
ABU-28	5	
ABU-29P	5	

REF.	PAG.	PAG.
ABU-30	5	
ABU-30D	5	
ABU-32D	5	
ABU-34	5	
ABU-35P	5	143
ABU-36P	5	143
ABU-37D	3	
ABU-38D	5	
ABU-39P	5	
ABU-40	5	
ABU-41	5	
ABU-41D	5	
ABU-42	5	
ABU-42D	5	
ABU-43D	3	
ABU-44	3	
ABU-45	5	
ABU-46	3	
ABU-46D	3	
ABU-47	3	
ABU-48	4	
ABU-49	3	
ABU-50	6	
ABU-51D	6	
ABU-52D	3	
ABU-53	3	
ABU-54	6	
ABU-54D	6	
ABU-55	3	
ABU-55D	3	
ABU-57D	6	
ABU-58D	4	
ABU-60	6	
ABU-61	6	
ABU-63	6	
ABU-64P	6	143
ABU-65P	6	143
ABU-66	6	
ABU-67	3	
ABU-67D	3	
ABU-68	5	
ABU-69	3	
ABU-70	4	
ABU-71D	3	
ABU-72P	6	143
ADS- 1D	6	
AEP- 1D	6	
AEP- 2D	6	
AF- 1D	204	
AF- 1I	204	
AF- 2D	205	
AF- 2I	205	
AF- 3D	205	
AF- 3I	205	

REF.	PAG.	PAG.
AF- 4D	205	
AF- 4I	205	
AF- 5D	205	
AF- 5I	205	
AF- 6D	205	
AF- 6I	205	
AF- 7D	207	
AF- 7I	207	
AF- 7IP	207	
AF- 7IP1	207	
AF- 8D	207	
AF- 8DP	207	
AF- 8I	207	
AF- 8IP	207	
AF- 9D	207	
AF- 9DP	207	
AF- 9I	207	
AF- 9IP	207	
AF-10	205	
AF-11	205	
AF-12	205	
AF-13	161	
AF-13P	161	
AF-14	161	
AF-14P	161	
AF-19	205	
AF-19P	205	
AF-21	205	
AF-21P	205	
AG- 1D	9	
AG- 1I	9	
AG- 3D	9	
AG- 3I	9	
AG- 4D	9	
AG- 4I	9	
AG- 5D	9	
AG- 5I	9	
AG- 6D	9	
AG- 6I	9	
AG- 8D	9	
AG- 8I	9	
AG- 9D	9	
AG- 9I	9	
AG-10D	9	
AG-10I	9	
AG-11	9	
AG-11D	9	
AGA- 1I	6	
AGA- 1T	6	
AGA- 2T	7	
AGA- 3I	7	
AGA- 4D	7	
AGA- 4I	7	
AGA- 5D	7	

ÍNDICE GENERAL

GENERAL INDEX

REF.	PAG.	PAG.
AGA- 5I	7	
AGA- 6D	7	
AGA- 6I	7	
AGA- 7	7	
AGA- 8D	7	
AGA- 9I	7	
AGA-10	7	
AGA-11	7	
AGA-12	7	
AGA-13I	7	
AGA-14D	7	
AGA-15	8	
AGA-16I	8	
AGA-18D	7	
AGA-18I	7	
AGA-19D	7	
AGA-19I	7	
AGA-20	8	
AGA-22	7	
AGA-23	7	
AGA-24D	8	
AGA-24I	8	
AGA-25	8	
AGA-29	8	
AGA-38	8	
AGA-39	8	
AGA-42	8	
AGA-43	8	
AGA-44	8	
AGB- 1	8	
AGB- 1D	8	
AGB- 2	8	
AGB- 3	8	
AGB- 3D	8	
AGB- 4	9	
AGB- 5	9	
AGD-1	9	
AGD-2	9	
AGE- 1I	9	
AGE- 2D	9	
AGU- 1D	9	
AHR-2	9	
AHR-3	9	
AIZ- 1	9	
AIZ- 2D	9	
AKS-1	144	
AL- 1I	10	
AL- 2	10	
AL- 3	10	
ALC- 1D	10	
ALE- 1	10	
ALE- 1D	10	
ALF- 1	10	
ALF- 2	10	
ALF- 3	10	
ALF- 4	10	
ALF- 5	10	
ALF- 6	10	
ALF- 7	10	
ALF- 8	10	

REF.	PAG.	PAG.
ALF- 9	10	
ALF-10	10	
ALF-10D	10	
ALF-11D	10	
ALF-12D	10	
ALF-13D	10	
ALF-14D	10	
ALF-15	10	
ALF-16	10	
ALF-17	10	
ALF-18	10	
ALF-19	10	
ALF-20	10	
ALF-21	10	
ALF-22D	10	
ALF-23	10	
ALF-24	10	
ALF-25	10	
ALF-26	10	
ALF-27	10	
ALF-28	10	
ALF-29	10	
ALF-30	10	
ALF-31	10	
ALF-32D	10	
ALF-33	10	
ALF-34	10	
ALF-35	10	
ALF-36	10	
ALI-1	33	
ALP- 1D	10	144
ALP- 1I	10	144
ALP- 2	10	144
ALP- 2D	10	144
ALP- 3	10	
ALP- 4D	11	
ALP- 5D	11	
ALP- 6	10	144
ALP- 6D	10	144
AMA- 1	11	
AMA- 1D	11	
AMB- 1	1	
AMB- 1D	1	
AMG- 1	11	
AMG- 2D	11	
AMG- 3D	11	
AMG- 4D	11	
AMG- 5D	11	
AMG- 8D	11	
AMG- 9D	11	
AMG-10	11	
AMG-10D	11	
AMM-1	144	
AMM-2	144	
ANA- 1	12	
ANA- 1D	12	
ANC- 1D	12	
ANC- 2	12	
ANK- 1	12	
ANK- 2	12	

REF.	PAG.	PAG.
ANK- 3	12	
ANK- 4	12	
ANK- 6	12	
ANK-17	12	
ANK-47D	12	
ANK-65	12	
AP- 1D	12	
AP- 2D	12	
AP- 3D	12	
AP- 4D	13	
AP- 5D	13	
AR- 1D	13	
AR- 4DP	13	
AR- 4IP	13	
ARC-17DP	13	
ARC-17P	13	
ARE- 1D	13	
ARFE- 1D	13	
ARFE- 1I	13	
ARFE- 3D	13	
ARN- 1	13	
ARN- 2D	13	
ARO- 1D	13	
ARR- 1	13	
ARR- 2	13	
ARR- 3	13	
ARR- 7D	14	
ARR- 8	13	
ARR- 9D	14	
ARS- 1D	14	
AS- 1D	144	
AS- 1I	144	
AS- 2D	144	
AS- 2I	144	
AS- 3D	14	
AS- 3I	14	
AS- 4D	14	
AS- 5D	14	
AS- 6D	14	
AS- 7D	14	
AS- 8D	14	
AS- 9D	14	
AS-10D	14	
AS-11D	14	
AS-12D	14	
AS-13D	14	
AS-14D	14	
AS-15D	14	
AS-16D	14	
AS-17D	144	
AS-18D	14	
AS-19D	144	
AS-20D	14	
AS-21	144	
AS-21D	144	
AS-21DP	144	
AS-21P	144	
AS-22	14	
AS-23D	14	
AS-24	144	

REF.	PAG.	PAG.
AS-24D	144	
AS-25D	14	
AS-A5	15	
AS-A7	15	
AS-AK5	15	
AS-AK7	15	
AS-AL5	15	
AS-AL7	15	
AS-AM5	15	
AS-AM7	15	
AS-B5	15	
AS-B7	15	
AS-BK5	15	
AS-BK7	15	
AS-BL7	15	
AS-BM7	15	
AS-D7	15	
AS-DD7	16	
AS-DK5	15	
AS-DK7	15	
AS-DL5	15	
AS-DL7	15	
AS-DM5	15	
AS-DM7	15	
AS-E5	15	
AS-E7	15	
AS-EK5	15	
AS-EK7	15	
AS-EL5	15	
AS-EL7	15	
AS-EM5	15	
AS-EM7	15	
AS-F5	15	
AS-F7	15	
AS-FK5	15	
AS-FK7	15	
AS-FL7	15	
AS-FM7	15	
AS-G5	15	
AS-G7	15	
AS-GG7	15	
AS-GK5	15	
AS-GK7	15	
AS-GL5	15	
AS-GL7	15	
AS-GM5	15	
AS-GM7	15	
ASH-2	14	
AS-H7	15	
AS-HH7	16	
ASI-1	14	
AS-K7	15	
AS-KA7	16	
AS-KD7	16	
AS-KE5	16	
AS-KE7	16	
AS-KF7	16	
AS-KG7	16	
AS-KK7	15	
AS-L7	15	

REF.	PAG.	PAG.
AS-LA7	16	
AS-LD7	16	
AS-LE7	16	
AS-LF7	16	
AS-LG7	16	
AS-M5	15	
AS-M7	15	
AS-MA7	16	
AS-MD7	16	
AS-ME5	16	
AS-ME7	16	
AS-MF7	16	
AS-MG7	16	
AS-MM5	15	
AS-MM7	15	
AS-N5	15	
AS-N7	15	
AS-NN5	15	
AS-NN7	15	
ASP- 1D	14	
AS-P5	15	
AS-P7	15	
AS-PA7	16	
AS-PB7	16	
AS-PF7	16	
AS-PG7	16	
AS-PH7	16	
AS-PN7	16	
AS-PP7	16	
AS-PR7	15	
AS-PT7	16	
AS-R7	15	
AS-RA7	15	
AS-RB7	15	
AS-RC7	15	
AS-RD7	15	
AS-RE7	15	
AS-RF7	15	
AS-RG7	15	
AS-RH7	15	
AS-RK7	15	
AS-RN7	15	
AS-RR7	15	
AS-S7	15	
AS-SS7	15	
AS-T5	15	
AS-T7	15	
AS-TT7	16	
AS-U5	15	
AS-U7	15	
AS-UU7	16	
AS-V5	15	
AS-V7	15	
AS-VV7	16	
AS-W5	15	
AS-W7	15	
AS-WW7	16	
AS-X7	15	
AS-XX7	16	
AS-Z7	15	

REF.	PAG.	PAG.
ATA- 1	11	
ATA- 1D	11	
AU-1	167	
AU-AH	167	
AU-AHP	167	
AU-AHP1	167	
AU-AN	168	176
AU-ANP	168	176
AU-C	168	
AU-HV	168	
AU-HVP	168	
AU-HVP1	168	
AUM- 2D	16	
AU-W	168	
AV- 1	16	
AV- 1D	16	
AV- 2D	16	
AX- 1	144	
AX- 1D	144	
AX- 1DP	145	
AX- 1P	145	
AX- 2P	145	
AX- 3DP	145	
AZ- 1D	16	
AZ- 1I	16	
AZ- 2D	16	
AZ- 2I	16	
AZ- 3D	16	
AZ- 3I	16	
AZ- 4	16	
AZ- 6	16	
AZ- 7	17	
AZ- 8D	17	
AZ- 9	17	
AZ- 9D	17	
AZ-10	17	
AZ-12	17	
AZ-14	17	
AZ-17	17	
AZ-17D	17	
AZ-18	17	
AZ-18D	17	
AZ-29	17	
AZ-32	17	
AZKO- 1I	17	
B		
BAB- 1I	17	
BAB- 2I	18	
BAB- 3	18	
BAB- 3D	18	
BAB- 4D	18	
BAB- 5	18	
BAB- 5D	18	
BAB- 6	18	
BAB- 7	18	
BAB- 7D	18	
BAB- 8D	18	
BAB- 9D	18	
BAB-11	18	
BAB-12D	18	

REF.	PAG.	PAG.
BAG-1	18	
BAI- 1D	19	
BAI- 6	24	
BAI- 7	24	
BAI- 8D	19	
BAI- 9D	19	
BAN- 1D	18	
BAN- 1I	18	
BAN- 2D	18	
BAN- 3D	18	
BAS- 1D	145	
BAS- 1I	145	
BAS- 2D	145	
BAS- 2I	145	
BAS-3	145	
BAS-4	19	145
BAST- 1I	19	
BAST- 2D	19	
BAST- 3D	19	
BAST- 4DP	19	
BATU- 1I	19	
BCZ-1	19	
BCZ-2	19	
BD-1	17	
BDA-1	18	
BE- 1	20	
BE- 4D	20	
BE- 4I	20	
BE- 5D	20	
BE- 5I	20	
BES- 1D	20	
BES- 2D	20	
BES- 3D	20	
BES- 4D	20	
BES- 5D	20	
BES- 6D	20	
BES- 7D	20	
BES- 8D	20	
BES- 9D	20	
BES-10D	20	
BES-11D	20	
BES-12D	20	
BES-13D	20	
BES-14D	20	
BES-15D	20	
BES-16D	20	
BES-17D	20	
BEY- 1D	20	
BEY- 2D	20	
BH-1	145	
BH-1P	146	
BH-2	146	
BH-3	146	
BH-4	146	
BH-5	146	
BH-6	146	
BI- 1D	20	
BI- 2	20	
BI- 3D	20	
BIE-1	20	

REF.	PAG.	PAG.
BIF-1	20	118
BIL-1T	21	
BK- 1D	21	
BK- 1I	21	
BK- 2D	21	
BK- 3D	21	
BK- 4	21	
BK- 4D	21	
BK- 5D	21	
BK- 5I	21	
BK- 6D	21	
BK- 6I	21	
BK- 7D	21	
BK- 8D	21	
BK- 9	21	
BK-14	21	
BK-16/30	21	
BKY-1	22	
BKY-2	22	
BL- 1D	145	
BL- 1I	145	
BL- 2	145	
BL- 3	145	
BL- 4	145	
BL- 4D	145	
BL- 5	145	
BL- 5D	145	
BL- 6	145	
BL- 6D	145	
BLT-1	18	
BM-1P	168	
BM-2	168	
BM-2P	168	
BM-3	168	
BM-3P	168	
BM-4	169	
BM-5P	169	
BM-6P	168	
BM-B	168	
BM-HB	168	
BM-HBP	168	
BM-HBP1	168	
BM-NB	168	
BM-NBP	168	
BM-W	168	
BOD-1	21	
BOM- 1	22	
BOM- 1D	22	
BOM- 2	22	145
BOM- 2D	22	145
BRA- 1	88	
BRA- 2	22	146
BRAS-1	22	
BRI- 1D	22	
BRI- 1I	22	
BRI- 2D	22	
BRI- 2I	22	
BRI- 3D	22	
BRI- 3I	22	
BRI- 4D	22	

ÍNDICE GENERAL

GENERAL INDEX

REF.	PAG.	PAG.
BRI- 4I	22	
BRI- 6D	22	
BRI- 6I	22	
BRI- 7D	22	
BRI- 8I	22	
BRI- 9D	22	
BRI-10	23	
BRI-12	23	
BRI-13	22	
BRI-14	22	
BRI-14D	22	
BRI-15	22	
BRI-16	23	
BRI-17	22	
BRI-18	23	
BRI-18D	23	
BRI-19	23	
BRI-20	22	
BRI-21	22	
BRI-22	23	
BRI-23	23	
BRI-24	23	
BRI-25	23	
BRI-26	23	
BRI-27	23	
BRI-28	23	
BRI-29	23	
BRI-30	23	
BRI-31	23	
BRI-32D	23	
BRI-33	23	
BRR-1	19	
BRS-1	22	
BRU- 1	23	
BRU- 1D	23	
BS- 1I	146	
BS- 2	146	
BS- 3D	146	
BS- 4D	146	
BS- 5	146	
BS- 6	146	
BS- 7	147	
BS- 7D	147	
BS- 8	147	
BS- 8D	147	
BS- 9	147	
BS- 9D	147	
BSS- 1D	23	
BSS- 2	23	
BSS- 2D	23	
BSS- 3	24	
BSS- 4D	24	
BSS- 5D	24	
BTV- 1D	24	
BTV- 1I	24	
BTV- 2D	24	
BTV- 2I	24	
BU- 1D	26	
BU- 1I	26	
BUL- 1	24	

REF.	PAG.	PAG.
BUL- 2D	24	
BUL- 3D	24	
BUL- 4D	24	
BUL- 5D	24	
BUL- 6D	24	
BUL- 7D	24	
BUR- 1D	25	
BUR- 1I	25	
BUR- 2D	25	
BUR- 2I	25	
BUR- 3	25	
BUR- 3D	25	
BUR- 4	25	
BUR- 4D	25	
BUR- 5	25	
BUR- 5D	25	
BUR- 6	25	147
BUR- 7	25	
BUR- 8D	25	
BUR- 9	25	
BUR- 9D	25	
BUR-10	25	
BUR-10D	25	
BUR-11D	25	
BUR-12	25	
BUR-13D	26	
BUR-14	26	
BUR-14D	26	
BUR-15	26	
BUR-16	26	
BUR-17	26	
BUR-17D	26	
BUR-18D	26	
BUR-19D	26	
BUR-20D	26	
BUR-21D	26	
BUR-22D	26	
BUR-23D	25	
BUR-24	26	
BUR-24D	26	
BUR-25D	26	
BUS-1	26	
C		
C	27	
C-2	27	
CA- 1I	27	
CA- 2I	27	
CA- 3I	27	
CA- 4D	27	
CA- 4I	27	
CA- 5I	28	
CA- 6D	28	
CA- 7	28	
CA- 7D	28	
CA- 8D	28	
CA- 8I	28	
CA- 9I	27	
CA-10I	27	

REF.	PAG.	PAG.
CA-11I	28	
CA-12I	27	
CA-13D	28	
CA-14D	28	
CA-15I	28	
CAM- 1D	147	
CAS- 1D	147	
CASAS-1T	27	
CAT-1P	147	
CAT-2	147	
CAT-3	147	
CAY- 1D	28	
CAY- 1I	28	
CAY- 2	28	
CE- 1D	29	
CE- 1I	29	
CE- 2D	29	
CE- 2I	29	
CE- 3D	29	
CE- 3I	29	
CE- 4D	29	
CE- 5	29	
CE- 5D	29	
CE- 6D	30	
CE- 6I	30	
CE- 7D	30	
CE- 7I	30	
CE- 8D	30	
CE- 9D	30	
CE-10D	30	
CE-11D	30	
CE-12D	30	
CE-13D	30	
CE-14D	30	
CE-15D	30	
CE-16D	30	
CE-17D	30	
CE-18D	30	
CE-19D	30	
CE-20D	30	
CE-21D	30	
CE-22D	30	
CE-23D	30	
CE-24D	30	
CE-25D	30	
CE-26D	30	
CE-27D	30	
CE-28D	30	
CE-29D	30	
CE-30D	30	
CE-31D	30	
CE-32D	30	
CE-33D	30	
CE-34D	30	
CE-35D	30	
CE-36D	30	
CE-37D	30	
CE-38D	30	
CE-39D	30	
CE-40D	30	

REF.	PAG.	PAG.
CE- 41D	30	
CE- 42D	30	
CE- 43D	30	
CE- 44D	30	
CE- 45D	30	
CE- 46D	30	
CE- 47D	30	
CE- 48D	30	
CE- 49	30	
CE- 49D	30	
CE- 50	30	
CE- 51	30	
CE- 51D	30	
CE- 52	30	
CE- 53D	31	
CE- 54	30	
CE- 55	30	
CE- 56	30	
CE- 57	30	
CE- 58	30	
CE- 59	30	
CE- 60	30	
CE- 61	30	
CE- 62	30	
CE- 63	30	
CE- 64	30	
CE- 65	30	
CE- 66	30	
CE- 67	30	
CE- 68	30	
CE- 69	30	
CE- 70	30	
CE- 71	30	
CE- 72	30	
CE- 73	30	
CE- 74	30	
CE- 75	30	
CE- 76	30	
CE- 77	30	
CE- 78	30	
CE- 79	30	
CE- 80	30	
CE- 81	30	
CE- 82	30	
CE- 83	30	
CE- 84	30	
CE- 85	30	
CE- 86	30	
CE- 87	30	
CE- 88	30	
CE- 89	31	
CE- 89D	31	
CE- 90D	30	
CE- 92	29	
CE- 92D	29	
CE- 93D	29	
CE- 94	31	
CE- 96	31	
CE- 97	31	
CE- 98D	31	

REF.	PAG.	PAG.
CE-99D	29	
CE-100D	29	
CE-101D	29	
CE-102	31	
CE-103	31	
CE-104D	31	
CE-105	31	
CE-106	31	
CE-107	31	
CE-108	29	
CE-109D	31	
CE-110	29	
CE-111D	31	
CE-114	31	
CE-117D	31	
CE-118D	30	
CEM-BP	147	
CEM-JC	147	
CENT-1D	28	
CENT-1I	28	
CENT-2D	28	
CENT-2I	28	
CENT-3D	28	
CENT-4	29	
CER-1	29	
CF-1D	32	
CF-1I	32	
CHA-2	31	
CHA-2D	31	
CHEK-1	32	
CHI-1	32	
CHI-1T	32	
CHI-2	32	
CHI-3	32	
CHI-4	32	
CHI-5	32	
CHI-6	32	
CHI-7D	32	
CHI-8D	32	
CHI-9D	32	
CHI-10D	32	
CHR-1	147	
CHR-2	147	
CHR-3	148	
CHR-3P	148	
CHR-4D	203	
CHR-4I	203	
CHR-5	148	
CHR-6	148	
CHR-6D	148	
CHR-7	148	
CHR-7P	148	
CHR-8	148	
CHR-8P	148	
CHR-9	148	
CHR-9P	148	
CHR-10	148	
CHR-10P	148	
CHR-11	148	
CHR-11P	148	

REF.	PAG.	PAG.
CHR-12	149	
CHR-13D	149	
CHR-14	149	
CHR-14P	149	
CHR-15	149	
CHR-15P	149	
CHR-17	149	
CHTZ-1	31	
CHU-1D	32	
CHU-10	32	
CI-1D	33	
CI-1I	33	
CI-2	35	
CI-2I	35	
CI-3D	33	
CI-4D	33	
CI-4DP	33	
CI-4I	33	
CI-4IP	33	
CI-5DP	33	
CI-5IP	33	
CI-6D	33	
CI-6I	33	
CI-7D	33	
CI-8D	35	
CI-9D	35	
CI-10D	35	
CI-11D	35	
CI-12	35	
CI-13	35	
CI-14	33	
CI-15	35	
CI-15D	35	
CI-16D	35	
CI-17	33	
CI-18	35	
CI-19D	33	
CI-20	34	
CI-20D	34	
CI-21	34	
CI-22D	34	
CI-23D	34	
CI-24	34	
CI-25	34	
CI-26	34	
CI-27	35	
CI-28D	34	
CI-29	35	
CI-30	34	
CI-31	34	
CI-32	34	
CI-33	34	
CI-34	35	
CI-35	34	
CI-36	35	
CI-38D	35	
CI-39D	33	
CI-41	34	
CI-42	35	
CI-43D	34	

REF.	PAG.	PAG.
CI-44D	33	
CI-45D	34	
CI-46D	34	
CI-48	34	
CI-49	35	
CI-51	35	
CI-51D	35	
CI-53	35	
CI-55D	35	
CI-56	34	
CI-57	35	
CI-58D	33	
CI-59	34	
CI-60	34	
CI-61	35	
CI-DL	35	
CIE-1D	32	
CIF-1D	32	
CIF-2D	32	
CIF-3	32	
CIF-3D	32	
CIF-4	33	
CI-IL	35	
CIL-1	33	
CIL-1D	33	
CIL-2D	33	
CIL-3D	33	
CIL-4	33	
CIL-4D	33	
CIL-5D	33	
CIS-1D	27	
CIS-1I	27	
CIS-2	27	
CIS-3	27	
CIS-4	27	
CIS-5	27	
CIS-6D	27	
CL-1I	35	149
CL-2D	149	
CL-2I	149	
CL-3I	149	
CL-4I	149	
CL-5D	149	
CL-6	149	
CL-6P	150	
CL-7P	150	
CL-8P	150	
CL-9P	150	
CLF-1	35	
CLI-1D	150	
CLK-1	39	
CLS-1D	35	
CLU-1D	150	
CLU-1I	150	
CLU-2	150	
CLU-3	150	
CLU-4	150	
CLU-5	150	
CMA-1	28	
CMA-1D	28	

REF.	PAG.	PAG.
CMA-2	28	
CMA-2D	28	
CN-1D	147	
CO-1D	39	
COB-1P	150	
COB-2	150	
COH-1	35	
COH-2	35	
COH-2D	35	
COH-3	36	
COH-4	36	
CO-M	39	
COM-1D	36	
COR-1D	36	
COR-1GD	36	
COR-1I	36	
COR-2D	36	
COR-2I	36	
COR-3D	36	
COR-3	36	
COR-7	36	
COR-8	36	
COR-9	36	
COR-10	36	
COR-11	36	
COR-11D	36	
COR-12	36	
COR-13	36	
COR-13D	36	
COR-15D	37	
COR-16D	36	
COR-17D	37	
COR-18D	36	
COR-19D	36	
COR-20	37	
COR-20/25	37	
COR-20D	37	
COR-21D	36	
COR-22D	36	
COR-23D	37	
COR-24	37	
COR-25	37	
COR-25I	37	
COR-26	37	
COR-27D	37	
COR-28	37	
COR-29D	37	
COR-30	38	
COR-31	38	
COR-32	38	
COR-33	38	
COR-34	38	
COR-35	38	
COR-36D	36	
COR-37	38	
COR-40	38	
COR-48	36	
COR-49	36	
COR-50/60	38	
COR-50/60I	38	

ÍNDICE GENERAL

GENERAL INDEX

REF.	PAG.	PAG.
COR- 64	37	
COR- 65	37	
COR- 66	37	
COR- 67	37	
COR- 68	37	
COR- 69	36	
COR- 70D	38	
COR- 71	37	
COR- 72	36	
COR- 73	37	
COR- 74	37	
COR- 76D	36	
COR- 77	38	
COR- 78	38	
COR- 79	36	
COR- 80	36	
COR-114	38	
COT- 1D	39	
CSB- 1D	27	
CSB- 2D	27	
CT-1	205	
CT-1P	205	
CT-2	205	
CT-2P	205	
CT-2P1	205	
CT-3	206	
CT-3P	206	
CT-4P	206	
CUB-1	39	
CVL- 1D	39	
CVL- 1I	39	
CVL- 2D	39	
CVL- 2I	39	
CVL- 3D	39	
CVL- 3I	39	
CVL- 4	39	
CVL- 5D	39	
CVL- 5I	39	
CVL- 6	39	
CVL- 8D	39	
CVL- 9D	39	

D

DAC- 1DP	150	
DAC- 2D	150	
DAC- 3DC1	150	
DAD- 1D	39	
DAD- 1I	39	
DAD- 2D	39	
DAD- 2I	39	
DAD- 3D	40	
DAD- 4D	40	
DAD- 5D	40	
DAD- 6D	40	
DAE- 1P	151	
DAE- 2DP	151	
DAE- 3DP1	151	
DAE- 3DP2	151	
DAE- 3P2	151	

REF.	PAG.	PAG.
DAE- 4DP1	151	
DAE- 4P1	151	
DAE- 5P	151	
DAF- 1	40	
DAF- 1D	40	
DAF- 2	40	
DAF- 3D	40	
DAF- 4D	40	
DAI- 1P	151	
DAI- 2D	151	
DAL-1P	151	
DAR-1	151	
DAT- 1D	199	
DAT- 1DP	199	
DAT- 1I	199	
DAT- 1IP	199	
DAT- 2D	199	
DAT- 2DP	199	
DAT- 2I	199	
DAT- 2IP	199	
DAT- 3D	199	
DAT- 3I	199	
DAT- 4D	199	
DAT- 4I	199	
DAT- 5D	199	
DAT- 6	199	
DAT- 6C1	199	
DAT- 6D	199	
DAT- 6DP	200	
DAT- 6DP1	200	
DAT- 6P	200	
DAT- 6P1	200	
DAT- 7	199	
DAT- 7P	200	
DAT- 7P1	200	
DAT- 8	200	
DAT- 8I	200	
DAT- 8IP	200	
DAT- 8IP1	200	
DAT- 8P	200	
DAT- 9D	200	
DAT- 9DP	200	
DAT- 9I	200	
DAT- 9IP	200	
DAT-10	200	
DAT-10P	200	
DAT-11	201	
DAT-11D	201	
DAT-11DP	201	
DAT-11P	201	
DAT-12	201	
DAT-13	201	
DAT-13P	201	
DAT-14	201	
DAT-14P	201	
DAT-15	201	
DAT-15C1	201	
DAT-15P	201	
DAT-16	201	
DAT-17	201	

REF.	PAG.	PAG.
DAT-17D	201	
DAT-18	201	
DAT-19	201	
DAT-19P	202	
DAT-20	202	
DAT-20P	202	
DAV-1	152	
DAV-1P	152	
DC- 1D	46	
DC- 2D	46	
DC- 3	46	
DC- 4D	46	
DEF- 1D	40	
DEK- 2	40	
DEK- 3	40	
DEK- 4	40	
DEK- 6D	40	
DEK- 7D	40	
DEK- 8	40	
DEK- 9D	40	
DEK-10	40	
DEK-11	40	
DEK-13	40	
DEK-14D	40	
DIA-1	41	
DIA-2	41	
DIA-3	41	
DIE-1	41	
DLC-1	41	
DLC-2	41	
DLC-3	41	
DLP-1	41	
DLP-2	41	
DM-1	41	
DO- 2I	46	
DO- 3	46	
DO- 4	46	
DO- 5	46	
DO- 5D	46	
DO- 7	46	
DOB- 1	152	
DOB- 1D	152	
DOB- 2	152	
DOB- 2D	152	
DOB- 3	152	
DOB- 3D	152	
DOI-1	46	
DOM- 1D	41	
DOM- 1DP	42	
DOM- 1I	41	
DOM- 2D	42	
DOM- 3D	42	
DOM- 3I	42	
DOM- 4	42	
DOM- 4D	42	
DOM- 5D	42	
DOM- 6D	42	
DOM- 6I	42	
DOM- 7D	42	
DOM- 7I	42	

REF.	PAG.	PAG.
DOM- 8D	42	
DOM- 9	42	152
DOM- 9D	42	152
DOM-10D	42	
DOM-11D	42	
DOM-11I	42	
DOM-12	42	
DOM-12D	42	
DOM-13D	42	
DOM-14D	42	152
DOM-15D	43	
DOM-16D	43	
DOM-17I	43	
DOM-18D	43	
DOM-20D	43	
DOM-21D	43	
DOM-22	43	
DOM-25D	43	
DOM-26	43	
DOM-26D	43	
DOM-27D/ 1	44	
DOM-27D/ 2	44	
DOM-27D/ 3	44	
DOM-27D/ 4	44	
DOM-27D/ 5	44	
DOM-27D/ 6	44	
DOM-27D/ 7	44	
DOM-27D/ 8	44	
DOM-27D/ 9	44	
DOM-27D/10	44	
DOM-27D/11	44	
DOM-27D/12	44	
DOM-27D/13	44	
DOM-27D/14	44	
DOM-27D/15	44	
DOM-27D/16	44	
DOM-27D/17	44	
DOM-27D/18	44	
DOM-27D/19	44	
DOM-27D/20	44	
DOM-27D/21	44	
DOM-27D/22	44	
DOM-27D/23	44	
DOM-27D/24	44	
DOM-27D/25	44	
DOM-27D/26	44	
DOM-27D/27	44	
DOM-27D/28	44	
DOM-27D/29	44	
DOM-27D/30	44	
DOM-27D/31	44	
DOM-27D/32	44	
DOM-27D/33	44	
DOM-27D/34	44	
DOM-27D/35	44	
DOM-27D/36	44	
DOM-27D/37	44	
DOM-27D/38	44	
DOM-27D/39	44	
DOM-27D/40	44	

REF.	PAG.	PAG.
DOM-27D/41	44	
DOM-27D/42	44	
DOM-27D/43	44	
DOM-27D/44	44	
DOM-27D/45	44	
DOM-27D/46	44	
DOM-27D/47	44	
DOM-27D/48	44	
DOM-27D/49	44	
DOM-27D/50	44	
DOM-27D/51	44	
DOM-27D/52	44	
DOM-27D/53	44	
DOM-27D/54	44	
DOM-27D/55	44	
DOM-27D/56	44	
DOM-27D/57	44	
DOM-27D/58	44	
DOM-27D/59	44	
DOM-27D/60	44	
DOM-27D/61	44	
DOM-28	44	
DOM-29	44	
DOM-30	44	
DOM-31	44	
DOM-32	45	
DOM-33	45	
DOM-34	45	
DOM-35	45	
DOM-35D	45	
DOM-36	45	
DOM-36D	45	
DOM-37	45	
DOM-37D	45	
DOM-38D	45	152
DOM-39	45	
DOM-40D	45	
DOM-41D	43	
DOM-42	45	
DOM-43	45	
DOM-44D	43	
DOM-45	43	
DOM-46D	43	
DOM-48	42	
DOM-49D	43	
DOM-51	45	
DOM-52	45	
DOM-B1	45	
DU-1	152	
DUR- 1D	46	
DX- 5	41	
DX- 5D	41	
DX- 6	41	
DX- 6D	41	

E

EC- 1	46	
EC- 1D	46	
ECH-1	152	

REF.	PAG.	PAG.
EG-1	46	
EG-2	46	
EI- 1D	47	
EI- 2D	47	
ELZ- 1D	47	
ELZ- 2	47	
ELZ- 3D	47	
ELZ- 4	47	
ELZ- 4D	47	
ELZ- 5D	47	
ELZ- 6D	47	
ELZ- 8D	47	
ELZ- 9	47	
ELZ-10	47	
ELZ-10D	47	
ELZ-11D	47	
ELZ-12	47	
ELZ-12D	47	
EMK-1	47	
EP- 1D	47	
ER- 1D	48	
ER- 2D	48	
ER- 3	48	
ER- 4D	48	
ES- 1D	48	
ES- 1I	48	
ESL- 1	48	
ESL- 1D	48	
ESS-1	48	
ESS-2	48	
ESS-3	48	
ESS-4	48	
ETS- 1D	48	
EU- 1	48	
EU- 2	49	
EU- 3	49	
EU- 4	49	
EU- 4D	49	
EU- 6	48	
EU- 7	49	
EU- 7D	49	
EU- 8D	49	
EU- 9	48	
EU-10D	48	
EU-11	49	
EUB-1	48	
EUR- 1D	48	
EV- 1	49	
EV- 2	49	
EV- 2I	49	
EV- 3D	49	
EV- 3I	49	
EV- 4D	49	
EV- 6D	49	
EV- 7D	49	
EV- 8D	49	
EV- 9D	49	
EV-10	49	
EV-11	50	
EV-11D	50	

REF.	PAG.	PAG.
EV-12D	50	
EV-13D	49	
EVE- 1	49	
EVE- 1D	49	
EVE- 2D	49	
EVE- 3D	49	
EVE- 4	49	
EX- 1D	50	
EXS- 1D	50	
EZ- 1D	50	
EZ- 1I	50	
EZ- 2I	50	
EZ- 3D	50	
EZ- 3I	50	
EZ- 4D	50	
EZ- 4I	50	
EZ-DS10	50	
EZ-DS10E	50	
EZ-DS15	50	
EZ-DS15R	50	

F

FA- 1	53	
FA- 1D	53	
FAB-1	152	
FAB-2	152	
FAC- 1D	51	
FAC- 1I	51	
FAC- 2D	51	
FAC- 2I	51	
FAC- 3D	51	
FAC- 3I	51	
FAC- 4D	51	
FAC- 5D	51	
FAC- 6D	51	
FAC- 7D	52	
FAC- 8D	51	
FAC- 9D	51	
FAC-10D	51	
FAC-11D	52	
FAC-12D	51	
FAC-13D	52	
FAC-14D	52	
FAC-15	52	
FAC-18	52	
FAC-19	52	
FAC-20D	52	
FAC-21	52	
FAC-21D	52	
FAC-22D	52	
FAC-23	52	
FAI-A	153	
FAI-B	153	
FAI-C	153	
FAI-D	153	
FAIN- 1I	52	
FAL- 1D	52	
FAL- 2D	52	
FAM-1	52	

REF.	PAG.	PAG.
FAM-2	53	
FAN- 1	53	
FAN- 1D	53	
FAR- 1D	153	
FAR- 1I	153	
FAR- 2D	153	
FAR- 2I	153	
FAR- 3	153	
FAR- 3D	153	
FAR- 4D	153	
FAS-1	53	
FAV- 1D	53	
FAV-2	53	
FAY- 1D	53	
FB- 1	50	
FB- 2D	51	
FB- 2I	51	
FB- 3	50	
FB- 4	51	
FB- 5	51	
FB- 6	51	
FB- 7	51	
FB- 8	51	
FB- 9	51	
FB-10	51	
FB-11	51	
FB-12	51	
FB-13	51	
FB-14	51	
FB-15	51	
FB-16	51	
FB-17	51	
FB-18	51	
FB-19	50	
FB-20	50	
FB-21	50	
FB-22	50	
FB-23	50	
FB-24	50	
FB-25	50	
FB-26	51	
FB-27	51	
FB-28	51	
FB-29	51	
FB-31	50	
FB-32	51	
FB-33	51	
FB-34	51	
FB-35	51	
FB-38	51	
FB-39	51	
FB-41	51	
FEC- 1D	53	
FEC- 2	53	
FEC- 3D	53	
FED-1	53	
FED-2	53	
FED-3	54	
FEM- 1D	154	
FEM- 1I	154	

ÍNDICE GENERAL

GENERAL INDEX

REF.	PAG.	PAG.
FEM- 2D	154	
FEM- 2I	154	
FEM- 3D	154	
FEM- 3I	154	
FER-1	54	
FF- 1	54	
FF- 1D	54	
FF- 2	54	
FF- 2D	54	
FF- 3	54	
FF- 5D	54	
FF- 6	54	
FF- 7D	54	
FF- 8D	54	
FF- 9D	54	
FF-10D	54	
FF-11	54	
FI- 1	161	
FI- 1P	161	
FI- 1P8	161	
FI- 2D	161	
FI- 2DP3	161	
FI- 3	161	
FI- 3D	161	
FI- 3DP	161	
FI- 3DP1	161	
FI- 3DP2	162	
FI- 3DP3	161	
FI- 3DP4	162	
FI- 3DP5	162	
FI- 4D	162	
FI- 5D	162	
FI- 5I	162	
FI- 6I	162	
FI- 6IP	162	
FI- 6IP1	162	
FI- 6IP2	162	
FI- 6IP3	162	
FI- 6IP4	161	
FI- 7I	162	
FI- 8I	162	
FI- 8IP	162	
FI- 8IP1	163	
FI- 9I	163	
FI- 9IP	163	
FI-10	161	
FI-10P	161	
FI-11	163	
FI-11KP	163	
FI-11P	163	
FI-12	161	
FI-12P	161	
FI-12P1	161	
FI-12P3	161	
FI-13	163	
FI-13P	163	
FI-13P1	163	
FI-13P7	163	
FI-14P	163	
FI-15	163	

REF.	PAG.	PAG.
FI-16C1	214	
FIA-1	154	
FIA-2	154	
FIC- 1	54	
FIC- 2	54	
FIC- 5	54	
FIC- 7	55	
FIC- 8	55	
FIC- 9	55	
FIC-18	55	
FIS- 1D	55	154
FLO- 1D	55	
FLO-1	55	
FO- 1	154	
FO- 2	154	
FO- 3	154	
FO- 3D	154	
FO- 3DP	154	
FO- 3P	154	
FO- 4P	154	
FO- 5	147	
FO- 6P	154	
FO- 7P	154	
FO- 8	154	
FO- 8D	154	
FO- 8DP	154	
FO- 8DP1	155	
FO- 9D	155	
FO- 9DP	155	
FO-10P	155	
FO-11D	155	
FO-12	155	
FO-12P	155	
FO-13DP	155	
FO-14DP	155	
FO-15D	155	
FO-15DP	155	
FO-17P	155	
FO-18D	156	
FO-20D	156	
FO-22P	156	
FO-24C1	169	
FO-24C2	169	
FO-ANP	156	
FO-D	156	
FO-E/TC	156	
FO-E/TCP	156	
FO-FHP	156	
FO-FK	156	
FO-FKP	156	
FO-FR	156	
FO-FRP	156	
FON-1E	55	
FON-2E	55	
FON-3E	55	
FON-4E	55	
FON-5E	55	
FON-6E	55	
FO-OA	156	
FO-OL	156	

REF.	PAG.	PAG.
FO-OR	156	
FO-PN	156	
FO-PRL	157	
FO-PRR	157	
FORTIS- 2I	56	
FO-SR	169	
FO-TC	157	
FO-TX	157	
FO-TX1	157	
FO-TX1P	157	
FO-TX2	157	
FO-TX2P	157	
FO-TXKP	157	
FO-TXP	157	
FO-XL	157	
FO-XR	157	
FR- 1D	55	
FR- 2	55	
FR- 4	55	
FR- 7D	56	
FR- 8	56	
FR- 9D	56	
FR-11D	56	
FTE- 1	56	
FTE- 1D	56	
FTH- 1	56	
FTH- 1D	56	
FTH- 2	56	
FTH- 3	56	
FTH- 4	56	
FTH- 5	56	
FTH- 6	56	
FTH- 7	56	
FTH- 8	56	
FTH- 8D	56	
FTH- 9	57	
FTH-10	57	
FTH-11D	57	
FTH-12D	57	
FTH-13D	57	
FTH-14D	57	
FTH-15	57	
FTH-16	57	
FTH-17D	57	
FTH-18	57	
FTH-19	57	
FTH-20D	57	
FTH-21	57	
FTH-22	56	
FTH-23	58	
FTH-24	58	
FTH-25	58	
FTH-26D	58	
FTH-27	58	
FTH-28	58	
FTH-29	58	
FV- 1D	53	

G

REF.	PAG.	PAG.
GAB- 1D	58	
GAB- 1I	58	
GAB- 2	58	
GAS- 1	157	
GAS- 1D	157	
GAT- 1	58	
GAT- 2D	58	
GAT- 3D	59	
GBZ-1	59	
GDA- 1P	60	
GDA- 3D	60	
GDA-30D	60	
GDA-50D	60	
GDA-60D	60	
GE- 1D	59	
GE- 2	59	
GE- 3D	59	
GE- 4D	59	
GE- 5	59	
GE- 5D	59	
GE- 6	59	
GE- 6D	59	
GE- 7	59	
GE- 8	59	
GE- 9	59	
GE-10D	59	
GE-11	59	
GE-15D	59	
GE-16D	59	
GE-19	59	
GEA- 1	59	
GEA- 2D	60	
GEA- 3	60	
GEA- 4D	60	
GEA- 5D	60	
GEB- 1D	59	
GG- 1D	152	
GH-1	160	
GH-GX	160	
GH-HX	160	
GH-PS	161	
GIB- 1D	60	
GIOB- 1D	164	
GIOB- 1DP	164	
GIOB- 2I	164	
GIOB- 2IP	164	
GIOB-3P	164	
GIU- 1	60	
GIU- 1D	60	
GIU- 2	60	
GIU- 2D	60	
GIU- 3D	60	
GIU- 4	61	
GLA- 1D	61	
GLA- 2D	61	
GLO- 1D	61	
GLO- 1I	61	

REF.	PAG.	PAG.
GLO- 2	61	
GLO- 2D	61	
GLO- 3	61	
GLO- 3D	61	
GLO- 4D	61	
GLO- 4I	61	
GLO- 5I	61	
GLO- 6	61	
GLO- 6D	61	
GLO- 7	61	
GLO- 7D	61	
GLO- 8	61	
GLO- 8D	61	
GLO- 9D	61	
GLO-10	62	
GLO-11	62	
GLO-12D	62	
GLO-22	62	
GLO-22D	62	
GLO-23	62	
GLO-23D	62	
GM- 1P	157	
GM- 2	157	
GM- 2P	158	
GM- 3P	158	
GM- 4	158	
GM- 4P	158	
GM- 4P1	158	
GM- 5	158	
GM- 5P	158	
GM- 6	158	
GM- 6P	158	
GM- 7	158	
GM- 7P	158	
GM- 8	158	
GM- 8P	158	
GM- 9	158	
GM- 9P	158	
GM-10	158	
GM-10P	158	
GM-11	158	
GM-11P	158	
GM-12	158	
GM-12P	158	
GM-13	158	
GM-13P	158	
GM-14	158	
GM-14P	159	
GM-15D	159	
GM-15DP	159	
GM-16P	159	
GM-17P	159	
GM-18P	159	
GM-19P	159	
GM-20P	159	
GM-21	159	
GM-21P	159	
GM-22	159	
GM-22P	159	
GM-23	159	

REF.	PAG.	PAG.
GM-23P	159	
GM-24	160	
GM-24P	160	
GM-25	160	
GM-25P	160	
GM-26	160	
GM-42	160	
GM-A	160	
GM-AP	160	
GM-B	160	
GM-BP	160	
GM-C	160	
GM-CP	160	
GM-D	160	
GM-DP	160	
GM-E	160	
GM-EP	160	
GM-H	160	
GM-HP	160	
GM-J	160	
GM-JP	160	
GM-K	160	
GM-KP	160	
GMT- 1	58	
GMT- 2	58	
GMT- 3D	58	
GMT- 4D	58	
GMT- 5D	58	
GR- 1D	62	
GR- 1I	62	
GR- 2D	62	
GR- 2I	62	
GR- 3D	62	
GR- 3I	62	
GR- 4D	63	
GR- 4I	63	
GR- 5D	63	
GR- 5I	63	
GR- 6	63	
GR- 6D	63	
GR- 7	63	
GR- 7D	63	
GR- 8	63	
GRG-1	62	
GTV- 1D	62	
GTV- 2	62	
GTV- 2D	62	
GTV- 3D	62	
GTV- 4D	62	
GTV- 5D	62	
GUA- 1	62	
GUA- 1D	62	
GUA- 2	62	
GUA- 2D	62	
GUA- 3	62	
GUA- 3D	62	

H

HA- 1D	164	
HA- 1I	164	

REF.	PAG.	PAG.
HAF- 1	63	
HAF- 1D	63	
HAF- 2	63	
HAF- 2D	63	
HAF- 3D	63	
HAF- 4	63	
HAG- 1D	63	
HAK- 1D	63	
HAK- 2D	63	
HAK- 3	63	
HAK- 4	63	
HAK- 5	63	
HAR- 1I	63	
HB-1	64	
HD- 1	164	
HD- 1D	164	
HD- 2	164	
HD- 2D	164	
HD- 3	164	
HD- 3D	164	
HEC-1	64	
HEK-1	64	
HEK-2	64	
HEK-3	64	
HEK-4	64	
HEL-1	64	
HEN- 1	64	
HEN- 1D	64	
HEN- 2	64	
HOB- 1	64	
HOB- 2D	64	
HOND- 1	164	
HOND- 1P	164	
HOND- 2	164	
HOND- 2P	164	
HOND- 3D	164	
HOND- 3I	164	
HOND- 4D	164	
HOND- 4DP	164	
HOND- 4DP1	165	
HOND- 4DP2	164	
HOND- 4I	164	
HOND- 4IP	164	
HOND- 4IP1	165	
HOND- 5D	165	
HOND- 5I	165	
HOND- 6D	165	
HOND- 6I	165	
HOND- 7D	165	
HOND- 7I	165	
HOND- 8D	165	
HOND- 8I	165	
HOND- 9D	165	
HOND- 9I	165	
HOND-10	165	
HOND-10P	165	
HOND-11	165	
HOND-11P	165	
HOND-12	165	
HOND-12P	165	
HOND-13	165	

REF.	PAG.	PAG.
HOND-13P	165	
HOND-14	165	
HOND-14P	165	
HOND-15	165	
HOND-15P	166	
HOND-16D	166	
HOND-16DP	166	
HOND-16DP1	166	
HOND-17P	166	
HOND-18DP	165	
HOND-18P	165	
HOND-19	166	
HOND-19D	166	
HOND-19DP	166	
HOND-19P	166	
HOND-20	166	
HOND-20D	166	
HOND-20DP	166	
HOND-20P	166	
HOND-21	166	
HOND-22DP	166	
HOND-23	166	
HOND-24P	167	
HOND-25P2	164	
HOND-26DP1	167	
HOND-26P1	167	
HOND-27D	167	
HOND-28DP	167	
HOND-28P	167	
HOND-29DP	167	
HOND-29P	167	
HOND-30DP2	164	
HOND-30P2	164	
HOR- 1	64	
HOR- 2	64	
HOR- 2D	64	
HRM-1	64	
HT-1	65	
HTE-50	65	
HU-1	169	
HU-2P	170	
HU-AN	170	
HUD- 1	167	
HUD- 1D	167	
HUD- 2D	65	167
HU-DF	170	
HU-DFP	170	
HU-DFP1	170	
HU-DHP	170	
HU-DNP	170	
HU-HAAC1	170	
HU-HAAC2	170	
HU-HAAC3	216	
HU-HAAC4	216	
HU-HAAP1	170	
HU-MN	170	
HU-MNP	170	
HU-NAAC2	170	
HU-P	171	
HU-SC	171	
HU-SR	171	

ÍNDICE GENERAL

GENERAL INDEX

REF.	PAG.	PAG.
HU-SU	171	
HU-SX	171	
HU-SY	171	
HU-SZ	171	
HUW- 1	65	177
HUW- 1D	65	177
HUW-N	65	177
HY- 1	177	
HY- 2	177	
HY- 2P	178	
HY- 3	178	
HY- 3D	178	
HY- 3DP	178	
HY- 3DP1	178	
HY- 3P2	178	
HY- 3P3	178	
HY- 4	178	
HY- 4P	178	
HY- 4P2	178	
HY- 4P3	178	
HY- 5	178	
HY- 5P	178	
HY- 6D	179	
HY- 6DP	179	
HY- 7P	179	
HY- 8	179	
HY- 8P	179	
HY- 9P2	179	
HY-11DP1	179	
HY-11DP3	179	
HY-11P3	179	
HY-12P3	179	

I

IB-1	65	
IB-2	65	
ICA- 1	65	
ICA- 4IP	65	
ICA- 5IP	65	
ICS- 1D	65	
ICS- 2D	65	
IF- 11	65	
IF- 2	66	
IF- 3P	66	
IF- 4	66	
IF- 5	66	
IF- 6	66	
IF-15	66	
IF-35	66	
IF-45/55	66	
IF-60/70	67	
IF-D20	66	
IF-D25	66	
IF-D30	66	
IF-I20	66	
IF-I25	66	
IF-I30	66	
IF-I40	66	
IF-I40L	66	
IF-I50	66	

REF.	PAG.	PAG.
IF-I51	66	
IF-I60/70	67	
IGS-1	67	
IL- 1D	67	
IL- 11	67	
IL- 2	67	
ILC- 1D	67	
ILC- 2D	68	
ILC- 3	68	
ILL- 1	68	
ILL- 2	68	
ILL- 2D	68	
IMB- 1	68	
IMB- 1D	68	
IMS- 3	205	
IMS- 3C	179	
IMS- 3P	205	
IMS- 5	205	
IMS- 5C	179	
IMS- 5P	205	
IMS- 6D	180	
IMS- 6I	180	
IMS- 7	180	
IMS- 7P	180	
IMS- 8	180	
IMS- 9	180	
IMS-10	180	
IMS-11P	180	
IMS-12	180	
IMS-13	205	
IMS-13P	205	
IMS-MER	180	
IN-1	214	
IN-4	214	
IN-5	214	
INCE-1E	68	
INCE-2E	68	
ING-6	68	
ING-A	68	
ING-D	68	
ING-M	68	
ING-N	68	
ING-S	68	
ING-W	68	
INT- 1	68	
INT- 1D	68	
IR-1P	68	
IS- 1D	69	
IS- 11	69	
IS- 2D	69	
IS- 2I	69	
IS- 3D	69	
IS- 3I	69	
IS- 4	69	
IS- 5D	69	
IS- 6D	69	
IS- 7D	69	
IS- 8	69	
IS- 8D	69	
IS- 10	69	
IS-10P	69	

REF.	PAG.	PAG.
IS-14D	69	
IS-15	69	
IS-16D	69	
IS-17D	69	
ISU- 1	180	
ISU- 2	180	
ISU- 3DP	180	
ITO- 1D	69	
ITO- 2D	69	
IV- 1	70	
IV- 2D	70	

J

JAR- 1D	70	
JAR- 1E	70	
JAR- 1I	70	
JAR- 2D	70	
JAR- 2I	70	
JAR- 3	70	
JAR- 4D	70	
JAR- 5D	70	
JAR- 5I	70	
JAR- 6	70	
JAR- 6D	70	
JAU-1P	210	
JGH- 1D	72	
JIN- 1D	70	
JIP- 1D	70	
JIP- 1I	70	
JIS- 1D	70	
JIS- 2I	70	
JIS- 3D	70	
JIS- 3I	70	
JIS-4P	71	
JMA- 1D	132	
JMA- 1I	132	
JMA- 2D	132	
JMA- 2I	132	
JMA- 3D	132	
JMA- 3I	132	
JMA- 4D	132	
JMA- 4I	132	
JMA- 9D	132	
JMA- 9I	132	
JNG- 1	72	
JNG- 1D	72	
JNG- 2D	72	
JNG- 3	72	
JO-1	71	
JOM- 1D	71	
JPM- 1D	71	
JPM- 1E	71	
JPM- 1I	71	
JPM- 2D	71	
JPM- 2E	71	
JPM- 2I	71	
JPM- 3D	72	
JPM- 4	71	
JPM- 4D	71	
JTF- 1I	72	

REF.	PAG.	PAG.
JTF- 2I	72	
JTF- 3	72	
JTF- 4	72	
JU- 1	72	
JU- 2	72	
JU- 2D	72	
JUNI- 1	72	
JUNI- 1D	72	
JUNI- 2	72	
JUNI- 2D	72	
JUNI- 3D	72	
JUNI- 4D	72	
JUNI- 5D	72	
JUNI- 6D	72	
JUNI- 7D	72	
JUNI- 8D	72	
JUNI- 9D	72	
JUZU-1	72	
JV- 1D	73	
JV- 1I	73	
JV- 2	73	
JV- 3D	73	
JV- 3I	73	
JV- 4I	73	
JV- 5I	73	
JV- 6	73	
JV- 7	73	
JV- 7D	73	
JWL- 1D	71	
JWL- 2D	71	
JWL- 3D	71	
JWL- 4D	71	
JWL- 5	71	
JWL- 6	71	
JWL- 7D	71	

K

KA- 1	73	
KA- 2	73	
KA- 3	73	
KA- 4	73	
KA- 5	73	
KA- 6	73	
KA- 7	73	
KA- 8	73	
KA-10	73	
KA-11	73	
KAE- 1	73	
KAE- 2	73	
KAE- 3	73	
KAE- 3D	73	
KAE- 4	74	
KAE- 5	74	
KAE- 6	74	
KAE- 6D	74	
KAE- 7	74	
KAE- 7D	74	
KAE- 8	74	
KAE- 8D	74	

REF.	PAG.	PAG.
KAE- 9	74	
KAE- 9D	74	
KAE-10D	74	
KAE-11D	74	
KAE-12D	74	
KAL- 1	74	
KAL- 2D	74	
KAM- 1	180	
KAM- 1D	180	
KAP- 1D	74	
KAP- 2D	74	
KAW- 1D	181	
KAW- 1I	181	
KAW- 2D	181	
KAW- 2I	181	
KAW- 3	181	
KAW- 4	181	
KAW- 5	181	
KAW- 5P	181	
KAW- 6DP	181	
KAW- 6P	181	
KAW- 7P	181	
KAW- 8	181	
KAW- 8D	181	
KAW- 9P	181	
KAZ- 1	74	
KAZ- 2	74	
KAZ- 3	74	
KAZ- 4	74	
KAZ- 5	75	
KAZ- 5D	75	
KAZ- 6	75	
KAZ- 7	75	
KE-1	75	
KE-3	75	
KE-4	75	
KEN- 1D	181	
KEN-1	181	
KFV-1	75	
KI- 1D	181	
KI- 1DP	181	
KI- 1DP1	182	
KI- 2D	182	
KI- 3DP	182	
KI- 3P	182	
KIC-1	75	
KIF- 1	75	
KIF- 1D	75	
KIF- 2D	75	
KIR- 1D	75	
KIR-2	75	
KNA- 1D	76	
KP-1	75	
KRA- 1D	76	
KRA- 2	76	
KRE- 1D	76	
KWI- 1	76	
KWI- 2D	76	
KYM- 1DP	182	
KYM- 1P	182	

REF.	PAG.	PAG.
KYM- 2	182	
KYM- 2D	182	
KYM- 2DP	182	
KYM- 2P	182	

L

LA- 1D	182	
LA- 1DP	182	
LA- 2	182	
LA- 2P	182	
LA- 3D	182	
LA- 3DP	182	
LA- 4D	183	
LA- 4DP	183	
LAF- 1D	76	
LAP- 1	76	
LAP- 1E	76	
LAP- 2D	76	
LAP- 2E	76	
LAP- 3D	76	
LAP- 3I	76	
LAP- 4	76	
LAP- 5D	77	
LAP- 6	76	
LAP- 7D	76	
LAP- 8D	77	
LAP- 9	77	
LAP- 9D	77	
LAP-10D	77	
LAP-11D	77	
LAP-13P	77	
LAP-17P	77	
LAP-20P	77	
LAP-21P	77	
LAP-22P	77	
LAP-23P	77	
LAP-28D	77	
LAP-29D	77	
LAP-30D	77	
LAP-34D	77	
LAP-42D	77	
LAP-43D	77	
LAP-44D	77	
LAP-45D	77	
LAP-46D	77	
LAP-88	77	
LAP-96D	77	
LAR- 1I	78	
LAS- 1D	78	183
LAS- 2	78	183
LAS- 3	78	183
LAS- 4	78	183
LAS- 4D	78	183
LAS- 5	78	183
LAS- 5D	78	183
LAS- 6	78	183
LAS- 6D	78	183
LAS- 7	78	

REF.	PAG.	PAG.
LAS- 8	78	
LAS- 9	78	
LAS-10	78	
LAS-11	78	
LAS-11D	78	
LAS-12D	78	
LAS-AX	78	183
LAS-AX/L	79	
LASB- 1	79	
LASB- 1D	79	
LASB- 2	79	
LASB- 2D	79	
LASB- 3D	79	
LAS-BT	183	
LAS-CR	183	
LAS-FH	78	183
LAS-KT	78	183
LAS-P	183	
LAS-R	79	183
LAS-RC	183	
LAS-SX	79	183
LAS-TB	183	
LAS-TK	78	183
LAS-TX	79	183
LAS-U	78	183
LAS-V	79	183
LAS-X	78	183
LAS-XS	79	183
LAS-XY	79	183
LAS-Y	79	183
LB- 1	81	
LB- 1D	81	
LB- 2D	81	
LB- 2DP	81	
LB- 3	81	
LB- 3D	81	
LB- 4D	81	
LEG- 1D	79	
LF- 1D	82	184
LF- 1I	82	184
LF- 2	82	184
LF- 3	184	
LF- 4I	82	184
LF- 5	82	184
LF- 5D	82	184
LF- 6	184	
LF- 7	82	184
LF- 7D	82	184
LF- 8	82	185
LF- 8D	82	185
LF- 9	185	
LF-10	82	
LF-11	82	185
LF-11D	82	185
LF-12	82	184
LF-12D	82	184
LF-13	83	
LF-13D	83	
LF-14D	83	
LF-15	83	185

REF.	PAG.	PAG.
LF-15D	83	185
LF-16	83	
LF-17	83	185
LF-18D	83	
LF-19	83	
LF-20	83	
LF-20D	83	
LF-21	83	
LF-22	83	
LF-23	83	
LF-24	83	
LF-25	84	
LF-26	84	
LF-27	84	
LF-28	84	185
LF-29D	84	
LF-30	84	
LF-31	84	
LF-32	82	184
LF-33D	83	
LF-34	84	
LF-35	84	
LF-36	84	
LF-37D	84	
LF-38D	84	
LF-39D	185	
LF-40	84	
LF-41	84	
LF-BL	185	
LF-RO	185	
LF-ROP	185	
LF-SL	185	
LF-SLP	185	
LF-WB	185	
LF-WBP	186	
LF-WR	186	
LIN- 1D	79	
LIN- 1I	79	
LIN- 2	79	
LIN- 3D	79	
LIN- 3I	79	
LIN- 4D	79	
LIN- 4I	79	
LIN- 5D	79	
LIN- 5I	79	
LIN- 6D	79	
LIN- 6I	79	
LIN- 7D	79	
LIN- 7I	79	
LIN- 8D	79	
LIN- 8I	79	
LIN- 9	80	
LIN-10D	80	
LIN-10I	80	
LIN-11D	80	
LIN-11I	80	
LIN-12D	79	
LIN-12I	79	
LIN-13	80	
LIN-14D	79	

ÍNDICE GENERAL

GENERAL INDEX

REF.	PAG.	PAG.
LIN-14I	79	
LIN-15D	79	
LIN-15I	79	
LIN-16	80	
LIN-16D	80	
LIN-17	79	
LIN-17D	79	
LIN-18	79	
LIN-18D	79	
LIN-19D	80	
LIN-20D	79	
LIN-21D	80	
LIP- 1D	80	
LIP- 1GD	80	
LIP- 1I	80	
LIP- 2	80	
LIP- 2D	80	
LIP- 3	80	
LIP- 4	80	
LIP-28D	80	
LIP-33	80	
LIT- 1I	81	
LIT- 2D	81	
LIT- 3D	81	
LIT- 5D	81	
LIT- 5I	81	
LIT- 7D	81	
LMP-1	183	
LMP-1P	183	
LMP-2	184	
LMP-2P	184	
LMP-3	184	
LMP-3P	184	
LMP-4	184	
LMP-4P	184	
LMP-4P1	184	
LMP-5	184	
LMP-5P	184	
LMP-5P1	184	
LO- 1D	82	
LO- 1I	82	
LO- 2D	82	
LO- 2I	82	
LO- 3D	82	
LO- 4D	82	
LOC- 1D	81	
LPO-1	78	
LPO-2	78	
LUC- 1D	85	
LUC- 2	85	
LUMA- 1D	85	
LUMA- 1I	85	
LUMA- 2D	85	
LUMA- 2I	85	
LUMA- 3D	85	
LUMA- 3I	85	
LUMA- 4D	85	
LUMA- 4I	85	
LWO- 1	81	
LWO- 1D	81	

REF.	PAG.	PAG.
LWO- 2	81	
LWO- 2D	81	
LWO- 7D	82	
LWO- 8	82	
LWO- 9	82	
LYF-1T	85	
LYF-2T	85	

M

MA- 5D	85	
MAR-1P	186	
MAS- 1	85	
MAS- 1D	85	
MAS- 2D	85	
MAS- 3D	85	
MAS- 4D	85	
MAS- 5D	86	
MAS- 6	86	
MAS- 7	86	
MAS- 7D	86	
MAS- 8	86	
MAS- 9	86	
MAS- 9D	86	
MAS-10	86	
MAS-10D	86	
MAS-11	85	
MAS-11D	85	
MAS-12D	85	
MAS-13D	86	
MAS-15P	86	
MAS-22D	85	
MASL-1	86	
MAZ- 1D	186	
MAZ- 1I	186	
MAZ- 2D	186	
MAZ- 2DP	186	
MAZ- 2I	186	
MAZ- 2IP	186	
MAZ- 3D	186	
MAZ- 3DP	186	
MAZ- 3I	186	
MAZ- 3IP	186	
MAZ- 4	186	
MAZ- 4P	186	
MAZ- 5D	186	
MAZ- 5DP	186	
MAZ- 6	187	
MAZ- 6D	187	
MAZ- 6DP	187	
MAZ- 6P	187	
MAZ- 7D	187	
MAZ- 7DP	187	
MAZ- 7DP1	187	
MAZ- 8D	187	
MAZ- 8DP	187	
MAZ-11D	187	
MAZ-11DP1	187	
MAZ-13D	187	
MAZ-13DP	187	

REF.	PAG.	PAG.
MAZ-13DP1	187	
MAZ-14D	188	
MAZ-15D	188	
MAZ-16	188	
MAZ-21DP1	188	
MBL- 1	91	
MBL- 1D	91	
MCH- 1	90	
MCH- 1D	90	
MCH- 2	90	
MCH- 2D	90	
MCL- 1D	86	
MCM- 1	86	
MCM- 2D	86	
MCM- 2I	86	
MCM- 3D	86	
MCM- 3I	86	
MCM- 4D	87	
MCM- 4EC	87	
MCM- 4I	87	
MCM- 4SS	87	
MCM- 5D	87	
MCM- 5I	87	
MCM- 6	87	
MCM- 7	87	
MCM- 8	87	
MCM-10	87	
MCM-11S	87	
MCM-12D	87	
MCM-13D	87	
MCM-16	87	
MCM-18D	87	
MCM-21D	87	
MCM-24B	88	
MCM-24C	88	
MCM-24D	88	
MCM-24E	88	
MCM-24F	88	
MCM-26	88	
MCM-29D	88	
MCM-30D	88	
MCM-31	88	
MCM-31D	88	
MCM-32D	88	
MCM-33	88	
MCM-35	88	
ME- 1	171	
ME- 1P	171	
ME- 2P	171	
ME- 3P	171	
ME- 4P	171	
ME- 5P	171	
ME- 6P	171	
ME- 7P	171	
ME- 8P	171	
ME- 9P	171	
ME-10P	172	
ME-11P	172	
ME-12P	172	
ME-13DP	172	

REF.	PAG.	PAG.
ME-14P	172	
MEC- 5D	88	
ME-HD	172	
ME-HDP	172	
ME-HF	172	
ME-HFP	172	
ME-HM	172	
ME-HMLP	172	
ME-HMP	172	
ME-HU	172	
ME-HUP	173	
ME-HY	172	
ME-HYP	173	
ME-HZ	172	
ME-HZP	172	
ME-L	173	
MEL- 1	88	
MEL- 2D	88	
MEL- 3	89	
MEL- 4	88	
MEL- 4D	88	
MEL- 5P	89	
ME-NU	172	
ME-NUP	173	
ME-NY	172	
ME-NYP	173	
MER- 1D	89	
MER- 1T	89	
MER- 2I	89	
MER- 3I	89	
MER- 4I	89	
MER- 5I	89	
MER- 6I	89	
MER- 7I	89	
MER- 8I	89	
MER- 9I	89	
MER-10I	89	
MER-11I	89	
MER-12I	89	
MER-13I	89	
MER-14I	89	
MER-15	89	
MER-16	89	
MER-16D	89	
MER-17	89	
MER-18	89	
MER-19D	89	
MER-20D	89	
MER-21D	89	
MERI- 1D	188	
MERI- 1DP	188	
ME-S	173	
ME-SP	173	
MET- 2D	90	
ME-VA	173	
MEZ- 1D	90	
MG- 6D	35	
MG- 6I	35	
MG- 6S	35	
MG- 9	35	

REF.	PAG.	PAG.
MGA- 1	90	
MGA- 1D	90	
MI- 1D	90	
MI- 2D	90	
MI- 3D	90	
MI- 4D	90	
MI- 5D	90	
MIL-1	90	
MIL-2	91	
MIN- 1D	91	
MIT- 1D	188	
MIT- 1DP	188	
MIT- 1I	188	
MIT- 1IP	188	
MIT- 2D	188	
MIT- 2DP	188	
MIT- 2I	188	
MIT- 2IP	188	
MIT- 3	188	
MIT- 3P	188	
MIT- 4	189	
MIT- 4P	189	
MIT- 5	189	
MIT- 5P	189	
MIT- 6	189	
MIT- 6P	189	
MIT- 7	189	
MIT- 7P	189	
MIT- 8D	189	
MIT- 8DP	189	
MIT- 9	189	
MIT-10	189	
MIT-11D	190	
MIT-12	190	
MIT-13D	190	
MIT-14D	190	
MIT-15P	189	
MIW-1	91	
MIW-2	91	
MIW-3	91	
MIW-4	91	
MLM- 1D	91	
MLM- 2	91	
MLM- 3	91	
MLM- 4	91	
MLM- 5	91	
MLM- 6	91	
MLM- 7	91	
MNO- 1D	92	
MOG- 1D	92	
MON- 1D	92	
MON- 1I	92	
MON- 2D	92	
MON- 2I	92	
MOS-1	190	
MP- 1D	92	
MP- 1I	92	
MQ- 1D	85	
MQ- 1I	85	
MIR-1	92	

REF.	PAG.	PAG.
MR-2	92	
MR-3	92	
MSM- 1D	93	
MSM- 2D	93	
MSV-1	93	
MSV-2	93	
MT-AG	92	
MT-AGP	92	
MT-CG	92	
MT-CGP	92	
MT-DGP	92	
MT-EG	92	
MT-EGP	92	
MT-GG	92	
MT-GGP	92	
MTL- 1	89	
MTL- 1D	89	
MTO-1	90	
MUL-T 2P	93	
MUL-T 3P1	93	
MUL-T 3PL	93	
MUL-T 4P	93	
MUL-T 5P	93	
MUL-T 6	93	
MUL-T 6D	93	
MUL-T10P	93	

N

NE- 1	190	
NE- 1D	190	
NE- 1DP	190	
NE- 1P	190	
NE- 2	190	
NE- 3	190	
NE- 3D	190	
NE- 3P	190	
NE- 3P1	190	
NE- 3P2	191	
NE- 4	191	
NE- 4D	191	
NE- 4P	191	
NE- 4P1	191	
NE- 4P2	191	
NE- 5	191	
NE- 6	191	
NE- 6P	191	
NE- 7	192	
NE- 8	192	
NE- 9	192	
NE- 9P	192	
NE-10	192	
NE-10P	192	
NE-11	192	
NE-11P	192	
NE-11P1	192	
NE-11P2	192	
NE-11P3	192	
NE-12	192	
NE-12P	193	

REF.	PAG.	PAG.
NE-13	193	
NE-14	193	
NE-15D	191	
NE-15DP	191	
NE-15DP1	191	
NE-15I	191	
NE-15IP	191	
NE-15IP1	191	
NE-16	193	
NE-18	192	
NE-18P	193	
NE-19	193	
NE-19P	193	
NE-19P1	193	
NE-20	193	
NE-20P	193	
NE-20P1	193	
NE-20P2	193	
NE-20P3	193	
NE-21P	194	
NE-22P	194	
NE-22P1	194	
NE-22P2	194	
NE-23	194	
NE-24	194	
NE-24P	194	
NE-24P1	194	
NE-25	194	
NE-26	194	
NE-27	194	
NE-28	194	
NE-29	194	
NE-29P	195	
NE-30	195	
NE-30P	195	
NE-31	195	
NE-31P	195	
NE-32	195	
NE-32P	195	
NE-33P	195	
NE-33P1	195	
NE-34P	195	
NE-35	195	
NE-35P	195	
NE-35P2	196	
NE-36	196	
NE-36KP	196	
NE-36KP1	196	
NE-36P	196	
NE-36P1	196	
NE-37	196	
NE-37P	196	
NE-38	196	
NE-38P1	196	
NE-39P	196	
NE-40	196	
NE-40P	197	
NE-41P	197	
NE-42	197	
NE-42P	197	

REF.	PAG.	PAG.
NE-42P1	197	
NE-43	197	
NE-44P	195	
NE-45	197	
NE-45P	197	
NE-46	197	
NE-47	197	
NE-48	197	
NE-49	197	
NE-50P	198	
NE-51P2	198	
NE-52P	198	
NE-53	198	
NE-54P	198	
NE-55P	198	
NE-56	198	
NE-57	198	
NE-58D	198	
NE-59P	198	
NE-60C1	198	
NE-60C2	199	
NO-1	93	

O

OA-1	95	
OCA- 1D	93	
OCA- 2D	93	
OF-1	94	
OF-2	94	
OJ- 1D	94	
OJ- 2I	94	
OJ- 3D	94	
OJ- 3I	94	
OJ- 4D	94	
OJ- 5I	94	
OJ- 6D	94	
OJ- 6I	94	
OJ- 7I	94	
OJ- 9D	94	
OJ-10	95	
OJ-11	95	
OJ-12	95	
OJ-13	95	
OJ-14	95	
OJ-15	95	
OJ-16	95	
OJ-17	95	
OJ-18P	95	
OJ-19	95	
OJ-J	94	
OJ-K	94	
OJ-L	94	
OJ-M	94	
OJ-Q	95	
OL- 5D	95	
OLIV-1	95	
OM-1	96	
OMC- 1D	95	
OMC- 2D	95	

ÍNDICE GENERAL

GENERAL INDEX

REF.	PAG.	PAG.
OMC- 3	95	
OMC- 4	96	
OMC- 5D	96	
OMC- 6D	96	
OMI- 1	96	
OMI- 1D	96	
ON- 1D	96	
ON- 1I	96	
OP- 1	173	
OP- 6	173	
OP- 7	173	
OP- 8	173	
OP- 9	173	
OP-11C1	173	
OP-AB	173	
OP-ABP	173	
OP-BA	173	
OP-BAP	173	
OP-BB	174	
OP-CC	174	
OP-D	174	
OP-DD	174	
OP-DKP	174	
OP-DP	174	
OP-EE	174	
OP-FF	174	
OP-HA	174	
OP-HB	174	
OP-HG	174	
OP-HH	174	
OP-J	174	
OP-JP	174	
OP-NA	174	
OP-NB	174	
OP-R	174	
OP-RP	174	
OP-S	174	
OP-SKP	174	
OP-SP	174	
OP-SP1	174	
OP-T	175	
OP-TP	175	
OP-WHC1	175	
OP-WHP	175	
OP-WYP	175	
OR- 1I	96	
ORK- 1D	96	
ORO- 1D	96	

P

PAD- 1D	96
PAD- 2D	96
PAD- 3	97
PAD- 3D	97
PAP-1	97
PAP-2	97
PAP-3	97
PAP-4	97
PAP-5	97

REF.	PAG.	PAG.
PAP-6	97	
PC- 1D	97	
PC- 1T	97	
PC- 2D	97	
PC- 3TP	97	
PCI-1T	96	
PEN- 1	97	
PEN- 1D	97	
PEN- 2	98	
PET-1	98	
PEU-1C1	216	
PEU-2C1	216	
PFA- 1	98	
PFA- 2	98	
PFA- 3	98	
PFA- 4	98	
PFA- 5	98	
PFA- 6	98	
PFA- 6D	98	
PFA- 7D	98	
PFA- 8D	98	
PFA- 9D	98	
PFA-10D	98	
PFA-11D	98	
PFA-12D	98	
PFA-13D	98	
PFA-14D	98	
PFA-15D	98	
PFA-16D	98	
PFA-17D	98	
PFA-18D	98	
PGO-1	202	
PGO-2P	202	
PHI-52	98	
PHO-1	98	
PIC- 1E	98	
PIC- 8D	98	
PJ-1	202	
PJ-2	202	
PJ-2P	202	
PJ-3	202	
PJ-K	202	
PJ-KP	202	
PLL-1	202	
PO-1P	175	
PO-2P	175	
PO-HC	175	
PO-HCP	175	
POL-3TEC	99	
POL-4E	99	
POL-5TEC	99	
PO-NC	175	
PO-NCP	175	
POS- 1DP	203	
PR- 1	99	
PR- 1D	99	
PR- 2	99	
PR- 3	99	
PR- 4D	99	
PR- 4I	99	

REF.	PAG.	PAG.
PR- 5D	99	
PR- 5I	99	
PR- 6	99	
PR- 7	99	
PR- 8	99	
PR- 9	99	
PR- 9D	99	
PR-10	99	
PR-11	99	
PR-12	99	
PR-13	99	
PR-14	99	
PR-15D	99	
PR-16	100	
PR-16D	100	
PR-17D	100	
PR-18	100	
PR-19	99	
PR-20	99	
PR-20D	99	
PRE- 1I	203	
PRE- 2I	203	
PRE-3	203	
PTN- 1D	99	
PTN- 2D	99	

R

RAZ- 1D	100
RE- 1	100
RE- 1D	100
RE- 2	100
RE- 2D	100
RE- 3D	100
RE- 4D	100
RE- 5D	100
REG- 1D	100
REX- 1D	100
RGM- 1D	100
RGM- 1I	100
RGM- 2	100
RI- 1D	101
RI- 1I	101
RI- 2D	101
RI- 2I	101
RI- 3D	101
RI- 3I	101
RIG- 1D	101
RIO- 1D	101
RIT- 1D	101
RO- 1D	101 203
RO- 1DS	203
RO- 1I	101 203
RO- 1IS	203
RO- 2D	101 203
RO- 2I	101 203
RO- 3	203
RO- 4D	101 203
RO- 4I	101 203
RO- 5D	101 203

REF.	PAG.	PAG.
RO- 5I	101	203
RO- 6D	101	203
RO- 6I	101	203
RO- 7D	101	203
RO- 7I	101	203
RO- 8D	101	203
RO- 8I	101	203
RO- 9D	101	
RO- 9I	101	
RO-10D	102	
RO-10I	102	
RO-11D	102	203
RO-11I	102	203
RO-12D	102	203
RO-12I	102	203
RO-14	204	
RO-15	204	
RO-16D	102	203
RO-16I	102	203
RO-17	204	
RO-18I	102	
RO-19D	102	
RO-19I	102	
RO-20D	102	
RO-20I	102	
RO-21D	102	
RO-21I	102	
RO-22I	102	
RO-23D	102	
RO-24D	102	
RO-24I	102	
RO-25D	102	
RO-25I	102	
RO-26D	102	
RO-26I	102	
RO-27D	102	
RO-27I	102	
RO-28D	102	
RO-28I	102	
RO-29D	102	
RO-30	101	203
RO-30D	101	203
RO-31D	102	
RO-32D	101	203
RO-33	101	203
RO-34D	102	
RO-36D	102	
RO-37	102	
RO-37D	102	
RO-38	102	
RO-38D	102	
RO-39	102	
RO-40	102	
RO-40D	102	
RO-41	102	
ROS- 1D	204	
ROS-2	204	
ROSE-1	103	
ROY-1	103	
RSS- 1	104	

REF.	PAG.	PAG.
RSS- 2D	104	
RST-1	22	
RU- 1D	103	
RU- 2D	103	
RU- 2I	103	
RU- 3D	103	
RU- 4D	103	
RU- 5D	103	
RU- 5I	103	
RU- 6I	103	
RU- 7D	103	
RU- 8D	103	
RU- 9D	103	
RU- 9I	103	
RU-10D	103	
RU-11D	103	
RU-12D	103	
RU-13D	103	
RU-14D	103	
RU-15	103	
RU-16D	103	
RU-GC	103	
RU-GK	103	
RU-GK7	103	
RU-GL	103	
RU-GL7	103	
RU-GM	103	
RU-GM7	103	
RU-GS	103	
RU-GS7	103	
RU-K	103	
RU-KD	103	
RU-L	103	
RU-M	103	
RUS-1	104	
RUS-2	104	
RU-TL	103	

S

SA- 1	104	
SA- 1D	104	
SA- 2	104	
SA- 3D	104	
SA- 3I	104	
SA- 4	104	
SAA-1P1	204	
SAA-2P	204	
SAA-AC	204	
SAA-ACP	204	
SABT-1	104	
SAG-1T	121	
SAM- 1D	104	
SAM- 2D	104	
SAR- 1	104	
SAR- 1D	104	
SAR- 2D	104	
SAR- 3D	105	
SAR- 4	105	
SAR- 4D	105	

REF.	PAG.	PAG.
SAR- 5D	105	
SAR- 6	105	
SAR- 6D	105	
SAT- 1D	105	
SAT- 2	105	
SCC- 1D	106	
SCH- 1D	106	
SCO-1	17	
SCR-1	106	
SEA-1	106	
SEA-2	106	
SE-AHP	175	
SE-AN	175	
SEC-1	106	
SEC-2	106	
SEC-3	106	
SEL- 1D	106	
SEL- 1I	106	
SEL- 2D	106	
SEL- 2I	106	
SEL- 3D	106	
SEL- 4D	106	
SH- 1I	107	
SHA-1	107	
SHI- 1	107	
SHI- 1D	107	
SHI- 2D	107	
SHI- 3D	107	
SHR-1	105	
SI- 1D	207	
SI- 2D	207	
SI- 3	207	
SI- 3D	207	
SI- 4	207	
SI- 4D	207	
SI- 5D	207	
SIM- 900	150	
SIM-1200	143	
SIP-1	207	
SIP-2	207	
SIP-3	207	
SIS- 1	107	
SIS- 2	107	
SIS- 3	107	
SIS- 4D	107	
SIS- 5D	107	
SIS- 6	107	
SIS- 6D	107	
SIS- 7D	107	
SIS- 8	108	
SIS- 8D	108	
SIS- 9	108	
SIS- 9D	108	
SIX-1	206	
SIX-1KP	206	
SIX-1P	206	
SIX-1P1	206	
SIX-1P2	206	
SIX-2	206	
SIX-2P	206	

REF.	PAG.	PAG.
SIX-2P2	206	
SIX-3P	206	
SIX-3P1	206	
SIX-3P2	206	
SIX-4	206	
SIX-4P	206	
SIX-5P	206	
SJL-1	108	
SKO- 1	153	
SKO- 1P	153	
SKO- 2	153	
SKO- 3I	153	
SKO- 3IP	153	
SKO- 4	153	
SKO- 5P	153	
SKO- 6	153	
SKO- 7	153	
SKO- 8	153	
SL-1	106	
SLG- 1	105	
SLG- 2	105	
SLG- 3	105	
SLG- 4	105	
SLG- 5	105	
SLG- 6	105	
SLG- 7	106	
SLG- 8	105	
SLG- 9	105	
SLG-10	105	
SLG-11	105	
SLG-12	105	
SLG-13	105	
SLG-14	105	
SLG-15	105	
SLG-16	105	
SLG-17	105	
SLG-18	105	
SLG-19	105	
SLG-20	105	
SLG-21	105	
SLG-22	105	
SLG-23	105	
SLG-24	105	
SLG-25	105	
SM- 1	107	
SM- 2	107	
SM- 3	107	
SM- 3D	107	
SM- 4	107	
SM- 4D	107	
SOF-1	108	
SOF-2	108	
SOFI- 1D	108	
SOFI- 1I	108	
SOFI- 2D	108	
SOFI- 2I	108	
SOFI- 3I	108	
SOFI- 4	108	
SOFI- 4D	108	
SOFI- 5	108	

REF.	PAG.	PAG.
SOFI- 6	108	
SOL-1	108	
SOP- 1D	108	
SOS- 1D	109	
SOS- 2D	109	
SOS- 3	109	
SOS- 4D	109	
SOS- 5	109	
SPI- 1	109	
SPI- 1D	109	
SQ- 1	109	
SQ- 2	109	
SQ- 3D	109	
SQ- 4	109	
SQ- 5D	109	
SQ- 6	109	
SQ- 7	110	
SQ- 8D	110	
SR- 1I	113	
SR- 2	113	
SR- 3	113	
SR- 4	113	
SR- 5	113	
SSO-1	108	
SSO-2	108	
ST- 1I	110	
ST- 2	110	
STA- 1	110	
STA- 1D	110	
STA- 2	110	
STA- 2D	110	
STA- 3	110	
STA- 3D	110	
STA- 4	110	
STA- 4D	110	
STA- 5	110	
STA- 5D	110	
STB- 1	112	
STB- 1D	112	
STE- 1	111	
STE- 2D	111	
STE- 3	111	
STE- 4	111	
STE- 5D	111	
STE- 6	111	
STE- 7	111	
STE- 8D	111	
STE- 9D	111	
STE-10	111	
STE-11	111	
STE-12	111	
STF- 1	112	
STF- 1D	112	
STK-1	110	
STL- 1D	110	
STL- 2I	110	
STR-1	111	
STR-2	111	
STR-3	207	
STR-4	111	207

ÍNDICE GENERAL

GENERAL INDEX

REF.	PAG.	PAG.
STR-5	111	
STS- 1D	111	
STS- 1DP	111	
STS- 1I	111	
STS- 2D	208	
STS- 2DP	208	
STS- 3D	111	
STS- 3I	111	
STS- 4D	111	
STS- 4DP	111	
STS- 5D	208	
STS- 5DP	208	
STS- 6D	111	
STS- 7D	112	
STS-11	208	
STS-12D	112	
STS-13D	112	
STS-21D	112	
STS-28	111	
STS-35	112	
STS-38	112	
STS-B1	112	
STS-T14	112	
STS-TV3	112	
STS-TV5	112	
STS-TV8	112	
STS-TV9	112	
STS-X5	112	
STS-X6	112	
STUV- 1D	112	
STUV- 1I	112	
STUV- 2	113	
SUB-2P	208	
SUZU- 1D	208	
SUZU- 1I	208	
SUZU- 2D	208	
SUZU- 2I	208	
SUZU- 3I	208	
SUZU- 4D	208	
SUZU- 4DP	208	
SUZU- 4I	208	
SUZU- 4IP	208	
SUZU- 5	208	
SUZU- 5P	208	
SUZU- 6	208	
SUZU- 7	209	
SUZU- 7DP	209	
SUZU- 7P	209	
SUZU- 8	209	
SUZU- 8P	209	
SUZU- 9P	209	
SUZU-10	209	
SUZU-10P	209	
SUZU-11D	209	
SUZU-11DP	209	
SUZU-12DP	209	
SUZU-13DP	209	
SUZU-13P	209	
SUZU-14P2	209	

REF.	PAG.	PAG.
T		
TAI-1	113	
TAL- 1	113	
TAL- 1D	113	
TAL- 2	113	
TAL- 3	113	
TAP-1P	210	
TAP-2	210	
TAT- 1D	210	
TAT- 1DP	210	
TAT- 2D	210	
TAT- 2DP	210	
TAY-1	114	
TE- 1D	114	
TE- 1I	114	
TE- 3	114	
TE- 4	114	
TE- 7D	114	
TE- 8D	114	
TE- 8DKT1	114	
TE- 8I	114	
TE- 9D	115	
TE-10I	115	
TE-11D	115	
TE-23	115	
TE-28	115	
TEC-2	114	
TEI- 1D	114	
TEM-D35	114	
TEM-D55	114	
TEM-I35	114	
TEM-I55	114	
TE-T10	115	
TE-T10D	115	
TE-T11	115	
TE-T12PLUS	115	
TE-T60	115	
TE-T62	115	
TE-T80	115	
TE-T80SC	115	
TE-T82	115	
TEU-1	210	
TH-1	115	
TI- 1	115	
TI- 1D	115	
TIF- 1D	116	
TIF- 2D	116	
TIF-15/20	116	
TIF-25D	116	
TIF-30D	116	
TIF-40D	116	
TIF-50/60	116	
TIG- 1D	116	
TIT- 1D	116	
TIT- 2	116	
TIT- 2D	116	
TIT- 3	116	
TIT- 4	116	
TIT- 5	117	
TIT- 6	117	

REF.	PAG.	PAG.
TIT- 7D	210	
TIT- 8D	117	
TIT- 9	117	
TIT- 9D	117	
TIT-10	116	
TIT-11D	117	
TIT-12D	117	
TIT-13	117	
TIT-14	117	
TIT-14D	117	
TIT-15	117	
TIT-15D	117	
TIT-16D	117	
TIT-17	117	
TIT-18D	117	
TK- 2D	114	
TK- 2I	114	
TKY-1	113	
TKY-2	113	
TOK- 2	117	
TOK- 2D	117	
TOK- 3	117	
TOK- 3D	117	
TOK- 4D	117	
TOK- 5D	118	
TOK- 6	118	
TOK- 6D	118	
TOK- 7D	118	
TOK- 8	118	
TOK- 9	118	
TOK-10D	118	
TOK-11	118	
TOK-12	118	
TOK-13D	118	
TOK-14D	118	
TOK-15	118	
TOK-16D	118	
TOK-17D	118	
TOK-18	118	
TOK-19	118	
TOK-20	118	
TOK-21	118	
TOK-22	118	
TOK-23	118	
TOK-24	118	
TOK-25	118	
TOK-26	118	
TOK-27	118	
TOK-28D	118	
TOK-29D	118	
TOK-30	118	
TOK-31	118	
TOK-32	118	
TOK-34D	118	
TOM- 1D	118	
TOP-1	119	
TOV-1	119	
TOV-2	119	
TOV-3	119	
TOV-4	119	

REF.	PAG.	PAG.
TOV-5	119	
TOV-6	119	
TOV-7	119	
TOYO- 2	210	
TOYO- 3	210	
TOYO- 3P	210	
TOYO- 4	211	
TOYO- 4P	211	
TOYO- 5	211	
TOYO- 5P	211	
TOYO- 5P1	211	
TOYO- 6	211	
TOYO- 8	211	
TOYO- 8IP	211	
TOYO- 8P	211	
TOYO- 9	211	
TOYO- 9P	211	
TOYO- 9P1	212	
TOYO-10	212	
TOYO-10P	212	
TOYO-10P1	212	
TOYO-11	212	
TOYO-11P	212	
TOYO-11P1	212	
TOYO-12	212	
TOYO-12D	212	
TOYO-12P1	212	
TOYO-13	212	
TOYO-13P1	212	
TOYO-14	211	
TOYO-14P	211	
TOYO-15	212	
TOYO-15P	212	
TOYO-16	212	
TOYO-16P	212	
TOYO-16P1	213	
TOYO-17	213	
TOYO-17P	213	
TOYO-18P	213	
TOYO-19P	213	
TOYO-20D	213	
TOYO-22	213	
TOYO-22D	213	
TOYO-23	213	
TOYO-23P	213	
TOYO-24	213	
TOYO-25	213	
TOYO-26	214	
TOYO-27	214	
TOYO-28P	214	
TOYO-29	214	
TOYO-30P1	214	
TOYO-K1	211	
TOYO-K1P	211	
TRI- 1D	119	
TRI- 1I	119	
TRI- 2D	119	
TRI- 2I	119	
TRI- 3D	119	
TRI- 3I	119	

REF.	PAG.	PAG.
TRI- 4D	119	
TRI- 4I	119	
TRI- 5D	120	
TRI- 5I	120	
TRI- 6D	120	
TRI- 6I	120	
TRI- 7D	120	
TRI- 7I	120	
TRI- 8D	120	
TRI- 8I	120	
TRI- 9D	120	
TRI- 9I	120	
TRI-10D	120	
TRI-10I	120	
TRI-11D	120	
TRI-11I	120	
TRI-12D	120	
TRI-12I	120	
TRI-13	120	
TRI-14	120	
TRI-15	120	
TRI-16	120	
TRI-17D	120	
TRI-18	120	
TRI-18D	120	
TRI-19	120	
TRI-19D	120	
TRI-20	120	
TRL-1P	119	214
TRO- 1	114	
TRO- 1D	114	
TRV- 1	119	
TRV- 1D	119	
TST-1	120	
TUL- 1D	121	
TUL- 2D	121	
TUS- 1D	121	
TUS- 2D	121	
TV- 1D	120	
TV- 2D	120	
TV- 3D	121	
TV- 4D	121	
TV-11	121	
TV-12	121	
TV-13	120	
TV-15D	121	
TV-16D	121	
TV-17	121	
TV-17D	121	
TV-18D	121	
TV-19D	121	
TV-20	121	
TV-21	121	
TV-22	121	
TV-22D	121	
TV-23	121	
TV-23D	121	
TX-1	124	
TZ- 1	121	
TZ- 1D	121	

REF.	PAG.	PAG.
U		
U- 1D	124	
U- 1I	124	
U- 2D	125	
U- 2I	125	
U- 3D	125	
U- 3I	125	
U- 4AD	125	
U- 4AI	125	
U- 4D	125	
U- 4I	125	
U- 4JD	125	
U- 4JI	125	
U- 4TD	125	
U- 4TI	125	
U- 5AD	125	
U- 5AI	125	
U- 5BD	125	
U- 5BI	125	
U- 5CD	125	
U- 5CI	125	
U- 5D	125	
U- 5DD	125	
U- 5DI	125	
U- 5DSP	126	
U- 5ED	125	
U- 5EI	125	
U- 5FD	126	
U- 5FI	126	
U- 5I	125	
U- 5JD	126	
U- 5JI	126	
U- 5KD	126	
U- 5KI	126	
U- 5MD	126	
U- 5MI	126	
U- 5PD	126	
U- 5PI	126	
U- 5QD	126	
U- 5QI	126	
U- 5SD	126	
U- 5SI	126	
U- 5SP	126	
U- 5TD	126	
U- 5TI	126	
U- 5VD	126	
U- 5VI	126	
U- 5XD	126	
U- 5XI	126	
U- 5YD	126	
U- 5YI	126	
U- 6BD	127	
U- 6D	127	
U- 6GD	127	
U- 6I	127	
U- 7	127	
U- 7D	127	
U- 8	127	

REF.	PAG.	PAG.
U- 8D	127	
U- 8PD	127	
U- 8TD	127	
U- 9	127	
U- 9D	127	
U-10D	127	
U-10I	127	
U-13D	127	
U-13I	127	
U-14D	127	
U-14I	127	
U-15	127	
U-15D	127	
U-15GD	128	
U-15GI	128	
U-16	128	
U-16D	128	
U-17	128	
U-17D	128	
U-18D	128	
U-19	128	
U-19D	128	
U-21	128	
U-21D	128	
U-22	128	
U-22D	128	
U-25	128	
U-25D	128	
UCEM- 1D	122	
UCEM- 1I	122	
UCEM- 2D	122	
UCEM- 2I	122	
UCEM- 3	122	
UCEM- 4I	122	
UCEM- 5D	122	
UCEM- 5I	122	
UCEM- 7D	122	
UCEM- 7I	122	
UCEM- 8D	122	
UCEM- 8DP	122	
UCEM-12	122	
UCEM-13D	122	
UCEM-17D	122	
UL- 1	122	
UL- 2D	123	
UL- 3	123	
UL- 4	123	
UMF-1	123	
UN- 1FS	123	214
UN- 2	123	214
UN- 3	123	214
UN- 4	214	
UN- 5D	123	
UN- 6D	123	
UN- 7D	123	
UN- 7I	123	
UN- 8D	124	
UN- 8I	124	
UN- 9D	124	
UN- 9I	124	

REF.	PAG.	PAG.
UN-10D	124	
UN-10I	124	
UN-11	124	
UN-12I	123	
UN-13D	123	
UN-13I	123	
UN-14D	123	
UN-14I	123	
UN-15D	123	
UN-15I	123	
UN-16D	123	
UN-16I	123	
UN-17D	123	
UN-17I	123	
UN-18D	123	
UN-18I	123	
UN-19D	123	
UN-19I	123	
UN-20D	123	
UN-20I	123	
UN-21D	123	
UN-21I	123	
UN-22D	123	
UN-22I	123	
UN-23D	123	
UN-23I	123	
UN-24D	123	
UN-24I	123	
UN-25D	123	
UN-25I	123	
UN-26D	123	
UN-26I	123	
UN-27D	123	
UN-27I	123	
UN-28I	124	
UN-29D	124	
UN-29I	124	
UN-30D	124	
UN-30I	124	
UN-31D	124	
UN-31I	124	
UN-32D	124	
UN-32I	124	
UN-33D	124	
UN-33I	124	
UN-34D	124	
UN-34I	124	
UN-35D	124	
UN-35I	124	
UN-36D	124	
UN-36I	124	
UN-37D	124	
UN-37I	124	
UN-38D	124	
UN-38I	124	
UN-39D	124	
UN-39I	124	
UN-40D	124	
UN-40I	124	
UN-41D	124	

ÍNDICE GENERAL

GENERAL INDEX

REF.	PAG.	PAG.
UN-41I	124	
UN-42D	124	
UN-42I	124	
UN-43D	124	
UN-43I	124	
UN-44	123	214
UN-44D	123	214
UN-45D	124	
UN-46D	124	214
UN-47	124	
UN-FFE	123	214
UN-FK	124	214
UN-FP	123	214
UN-FR	123	214
UN-FS	124	214
UN-FT	215	
UN-MRN	123	214
UN-NC	215	
UN-NG	123	214
UN-NH	215	
UN-NHP	215	
UN-TF	215	
URB- 1	128	
URB- 1D	128	
URB- 2	128	
URB- 3D	128	
URB- 4D	128	
URKO- 1D	128	
URKO- 1I	128	
URKO- 2D	128	
URKO- 2I	128	
URKO- 3D	129	
URKO- 3I	129	
URKO- 4	129	

V

VA- 1	129	
VA- 2	129	
VA- 3	129	215
VA- 3I	129	215
VA- 4	129	
VA- 4D	129	
VA- 5	129	
VA- 6	215	
VA- 6P	215	
VA- 7	215	
VA- 8D	129	
VA- 9D	130	
VA-10	215	
VA-11	131	
VA-12D	130	
VA-13D	129	
VA-13I	129	
VA-14D	130	
VA-15	130	
VA-16	215	
VA-17P	215	
VA-18	215	
VA-19	129	

REF.	PAG.	PAG.
VA-20	129	
VA-21	129	
VA-22	129	
VA-23	129	
VA-24D	130	
VA-24I	130	
VA-25	130	
VA-26	130	
VA-27	130	
VA-28	130	
VA-29	130	
VA-29D	130	
VA-30	130	
VA-31D	131	
VA-32D	131	
VA-33D	131	
VA-34	216	
VA-34P	216	
VA-34P1	216	
VA-35	130	
VA-35D	130	
VA-36	131	
VA-37	131	
VA-38	131	
VA-39	131	
VA-40	131	
VA-41	131	
VA-42	131	
VA-43	131	
VA-44	131	
VA-45	131	
VA-46	131	
VA-47	131	
VA-48	131	
VA-49	131	
VA-50	131	
VA-51	131	
VA-52	131	
VA-53	131	
VA-54	131	
VA-55	131	
VA-56	130	
VA-57	131	
VA-58	131	
VA-59	131	
VA-60	131	
VA-61C1	216	
VA-61C2	216	
VA-62	130	
VA-62D	130	
VA-70	132	
VA-75D	129	
VA-DHP	129	
VA-LA	129	
VA-LB	129	
VA-LC	129	
VA-LD	129	
VA-LE	129	
VA-LF	129	
VA-LG	129	

REF.	PAG.	PAG.
VA-LH	129	
VA-LN	129	
VA-RA	129	
VA-RB	129	
VA-RC	129	
VA-RD	129	
VA-RDH	129	
VA-RDM	129	
VA-RE	129	
VA-RF	129	
VA-RG	129	
VA-RH	129	
VA-RHM	129	
VA-RJ	129	
VA-RK	129	
VA-RL	129	
VA-RM	129	
VA-RN	129	
VA-ROK	129	
VB- 1D	132	
VB- 2D	132	
VE- 1D	132	
VG- 1D	134	
VGf- 4D	133	
VGf- 4I	133	
VGf- 5D	133	
VGf- 5I	133	
VI- 1D	133	
VI- 1I	133	
VI- 2D	133	
VI- 2I	133	
VI- 4D	133	
VI- 4DP	133	
VI- 4I	133	
VI- 4IP	133	
VI- 5D	133	
VI- 6D	133	
VI- 7	133	
VI- 8	133	
VI- 8D	133	
VI- 9D	133	
VI-10	134	
VI-11	134	
VI-11D	134	
VI-12	133	
VI-14	134	
VIN- 1D	133	
VLK-1	134	
VLK-2	134	
VND- 1	132	
VND- 1D	132	
VND- 2	132	
VND- 2D	132	
VND- 3	133	
VO- 1	175	
VO- 2	175	
VO- 2DP	176	
VO- 2DP1	176	
VO- 2KP	176	
VO- 2P	176	

REF.	PAG.	PAG.
VO- 2P1	176	
VO- 3KP	176	
VO- 4KP	176	
VO- 5P	176	
VO- 6D	176	
VO- 7	156	
VO- 8P	176	
VO- 8P1	176	
VO-AH	176	
VO-AHP	176	
VO-FH	176	
VO-FHP	176	
VO-FHP1	177	
VO-HV	176	
VO-HVP	176	
VO-K	177	
VO-L	177	
VOL- 1	216	
VOL- 1P	216	
VOL- 2	216	
VOL- 2D	216	
VOL- 3	216	
VOL- 4	217	
VOL- 5P	217	
VO-M	177	
VO-MP	177	
VO-N	176	
VO-NP	176	
VO-R	177	
VO-RP	177	
VO-VA	177	
VO-VAP	177	
VO-VB	176	
VO-VBP	176	
VO-VBP1	177	
VW-K70	177	

W

WA- 1D	134	
WA- 4D	134	
WA- 4I	134	
WA- 5D	134	
WA- 5DP	134	
WA- 5I	134	
WA- 5IP	134	
WAL- 1D	134	
WAL- 2D	134	
WAS- 1	217	
WAS- 2P	217	
WAS- 3	217	
WAS- 3P	217	
WAS- 4	217	
WAS- 4P	217	
WAS- 5	217	
WAS- 5P	217	
WAS- 6	217	
WAS- 6P	217	
WAS- 7D	217	
WAS- 7I	217	

REF.	PAG.	PAG.
WAS- 8	217	
WAS- 8D	217	
WAS- 9	217	
WAS- 9D	217	
WAS-10DP	217	
WAS-10P	217	
WBS-1	135	
WE- 4D	135	
WE- 4I	135	
WE- 5D	135	
WE- 5I	135	
WEB-1	135	
WEB-2	135	
WEB-3	135	
WEI-1	135	
WEI-2	135	
WEI-3	135	
WEI-4	135	
WEI-5	135	
WEI-6	135	
WES- 1D	135	
WIL- 1D	136	
WIL- 2D	136	
WIL- 3D	136	
WIL- 4D	136	
WIL- 5	136	
WIL- 5D	136	
WIL- 7	136	
WIL- 8	136	
WIL- 9	136	
WIL-10	136	
WIL-11	136	
WIL-12	136	
WIL-13	136	
WIL-14	136	
WIL-15	136	
WIL-16	136	
WIL-17D	136	
WIL-18	136	
WIL-19D	136	
WIL-20	136	
WIL-22	136	
WIN- 1D	136	
WIN- 1I	136	
WIN- 2D	136	
WIN- 3D	136	
WIN- 4D	137	
WIN- 5	137	
WIN- 5D	137	
WIN- 6D	137	
WIN-2I	137	
WIR-1	137	
WIT-1	218	
WM- 1D	137	
WM- 2D	137	
WM- 3D	137	
WM- 4D	137	
WM- 5D	137	
WST- 1D	135	
WST- 2D	135	218

REF.	PAG.	PAG.
Y		
YA- 1D	137	
YA- 1I	137	
YA- 2D	137	
YA- 2I	137	
YA- 3D	137	
YA- 3I	137	
YA- 5D	138	
YA- 5I	138	
YA- 6D	138	
YA- 6I	138	
YA- 7D	138	
YA- 7I	138	
YA- 8D	138	
YA- 8I	138	
YA- 9I	138	
YA-10	138	
YA-10D	138	
YA-11D	138	
YA-11I	138	
YA-12D	138	
YA-12I	138	
YA-13D	138	
YA-13I	138	
YA-14D	138	
YA-14I	138	
YA-15D	138	
YA-15I	138	
YA-16D	138	
YA-17D	138	
YA-17I	138	
YA-18D	218	
YA-19D	218	
YA-20D	218	
YA-20I	218	
YA-21D	218	
YA-21I	218	
YA-22D	138	
YA-22I	138	
YA-23	139	
YA-24D	139	
YA-24I	139	
YA-25D	139	
YA-25I	139	
YA-26I	138	
YA-27	139	
YA-27D	139	
YA-28	139	
YA-28D	139	
YA-29	138	
YA-30	139	
YA-31D	139	
YA-32D	137	
YA-33D	139	
YA-34D	139	
YA-36D	139	
YA-37	139	218
YA-37D	139	218

REF.	PAG.	PAG.
YA-38D	139	
YA-39	138	
YA-39D	138	
YA-46D	140	
YA-50	140	
YA-50D	140	
YA-51	140	
YA-51D	140	
YA-52D	140	
YA-53	139	
YA-53D	139	
YA-72	140	
YA-79D	140	
YA-81	140	
YA-85D	140	
YA-88	140	
YA-89	140	
YAMA- 1D	218	
YAMA- 1I	218	
YAMA- 2D	218	
YAMA- 2I	218	
YAMA- 3D	218	
YAMA- 3I	218	
YAMA- 4D	218	
YAMA- 5D	218	
YAMA- 5I	218	
YAMA- 6D	218	
YAMA- 6I	218	
YAMA- 7D	219	
YAMA- 7I	219	
YAMA- 8D	219	
YAMA- 8I	219	
YAMA- 9D	219	
YAMA- 9I	219	
YAMA-10D	219	
YAMA-10I	219	
YAMA-11D	219	
YAMA-11I	219	
YAMA-12D	219	
YAMA-12I	219	
YAMA-13D	219	
YAMA-13I	219	
YAMA-14D	219	
YAMA-14I	219	
YAMA-15D	219	
YAMA-15I	219	
YAMA-16D	219	
YAMA-16I	219	
YAMA-17D	219	
YAMA-17I	219	
YAMA-18D	219	
YAMA-18DP	219	
YAMA-18I	219	
YAMA-18IP	219	
YAMA-19D	219	
YAMA-19DP	219	
YAMA-19I	219	
YAMA-19IP	219	
YAMA-20D	219	
YAMA-20DP	219	

REF.	PAG.	PAG.
YAMA-20I	219	
YAMA-20IP	219	
YAMA-21I	219	
YAMA-21IP	219	
YAMA-22DP	220	
YAMA-22IP	220	
YAMA-23DP	220	
YAMA-23IP	220	
YAMA-24DP	220	
YAMA-24IP	220	
YAMA-25DP	220	
YAMA-26	220	
YAMA-26D	220	
YAMA-26DP	220	
YAMA-26P	220	
YAMA-27	220	
YAMA-27D	220	
YAMA-27DP	220	
YAMA-27P	220	
YAMA-28P	220	
YAMA-29P	220	
YAMA-30P	220	
YAR-1	140	
YAR-2	140	
YET- 1	140	
YET- 1D	140	
YET- 2	140	
YET- 2D	140	
YET- 3D	141	
YET- 4	141	
YET- 4D	141	
YET- 5	141	
YET- 5D	141	
YET- 6	141	
YET- 6D	141	
YET- 7	141	
YET- 7D	141	
YET- 8	141	
YET- 8D	141	
YET- 9	141	
YET- 9D	141	
YET-10	141	
YET-10D	141	
YET-11	141	
YET-11D	141	
YET-12	141	
YET-13	141	
YET-14	140	
YET-14D	140	
YET-15	141	
YET-16	140	
YU- 1D	220	
Z		
ZA- 1	141	220
ZA- 1P	141	220
ZA- 2P	220	
ZA- 3D	221	
ZA- 4DP	220	

ÍNDICE GENERAL

GENERAL INDEX

REF.	PAG.	PAG.
ZA- 5P	221	
ZA- 6DP	221	
ZA- 6DP1	221	
ZA- 7DP	221	
ZA- 8P	221	
ZA- 9P	221	
ZA- 9P1	221	
ZA-10	221	

REF.	PAG.	PAG.
ZA-12	141	
ZA-13P	221	
ZE- 1	67	
ZE- 1D	67	
ZE- 2	67	
ZE- 2D	67	
ZE- 5D	67	
ZE- 5I	67	

REF.	PAG.	PAG.
ZE- 6	67	
ZE- 6D	67	
ZE- 7D	67	
ZE- 8	67	
ZE- 9D	67	
ZE-10D	67	
ZE-11D	67	
ZE-13	67	

REF.	PAG.	PAG.
ZE-K1	67	
ZE-K2	67	
ZE-K5	67	
ZE-K6	67	
ZEN- 1D	141	
ZE-N1	67	
ZI-1	221	

LLAVES DE CIERRE

IXTEGO GILTZAK • SNAP-LOCK KEYS • CLÉS DE BOUCHE D'EAU • DORNSCHLÜSSEL

REF.	PAG.	PAG.
500	223	
501	223	
502	223	
503	223	

REF.	PAG.	PAG.
504	223	
505	223	
506	223	
507	223	

REF.	PAG.	PAG.
508	223	
509	223	
510	223	
511	224	

REF.	PAG.	PAG.
512	224	
513	224	

LLAVES EN CRUZ

GURUTZE-GILTZAK • CRUCIFORM KEYS • CLÉS CRUCIFORMES • KREUZBARTSCHLÜSSEL

REF.	PAG.	PAG.
A		
AGD-1X	226	
AGD-2X	226	
ALA-1X	226	

REF.	PAG.	PAG.
B		
BLU-1X	226	
BRI- 1X	226	
BRI- 2X	226	
BRI- 3X	226	
BUR- 1X	226	
BUR- 2X	226	
BUR- 3X	227	
BUR- 4X	227	
BUR- 5X	227	

REF.	PAG.	PAG.
C		
CCF- 1X	227	
CCF- 5X	227	
CCF- 8X	227	
CCF- 9X	227	
CCF-10X	227	
CIF-1X	228	
CRC-1X	228	

REF.	PAG.	PAG.
D		
DEB- 1X	228	
DOL-1X	228	

REF.	PAG.	PAG.
F		
FAY- 1X	228	
FM- 1X	228	
FM- 2X	228	
FRI-1X	228	
FRI-2X	229	

REF.	PAG.	PAG.
G		
GEA-1X	229	
GEA-3X	229	

REF.	PAG.	PAG.
I		
IS- 1X	229	

REF.	PAG.	PAG.
K		
KFV-1X	229	
KFV-2X	229	
KFV-3X	229	
KR- 1X	229	
KR- 2X	230	
KR- 3X	230	
KR- 4X	230	
KR- 5X	230	
KR- 6X	230	
KR- 7X	230	
KR- 8X	230	
KR- 9X	230	
KR-10X	231	
KR-11X	231	

REF.	PAG.	PAG.
L		
LCK-1X	232	

REF.	PAG.	PAG.
M		
MM-1X	232	
MOR-1X	232	
MOR-2X	232	
MSV-1X	232	

REF.	PAG.	PAG.
N		
NAB-1X	232	
NEF-1X	232	

REF.	PAG.	PAG.
P		
PAP-1X	233	
PAP-2X	233	

REF.	PAG.	PAG.
R		
RO- 1X	232	

REF.	PAG.	PAG.
T		
TUF-1X	233	
TUF-2X	233	
TUF-3X	233	

REF.	PAG.	PAG.
U		
U- 1X	233	

REF.	PAG.	PAG.
Y		
YA- 1X	233	
YA- 2X	233	
YA- 3X	234	
YA- 4X	234	
YA- 5X	234	
YA- 6X	234	

REF.	PAG.	PAG.
Z		
ZE- 1X	234	
ZE- 2X	234	
ZE- 3X	234	
ZE- 4X	234	
ZE- 5X	234	
ZE- 6X	234	
ZE- 7X	234	
ZE- 8X	235	
ZE- 9X	235	

LLAVES DE GORJA DE ACERO DULCE

ALTZAIRU GOZOZKO GORJA GILTZAK • MILD STEEL BIT KEYS

CLÉS À GORGES EN ACIER DOUX • CHUBBSCHLÜSSEL AUS WEICHSTAHL

REF.	PAG.	PAG.	REF.	PAG.	PAG.	REF.	PAG.	PAG.	REF.	PAG.	PAG.
74G	247		233G	241		1202G	247		1255G	252	
200G	237		234G	242		1203G	247		1256G	252	
201G	237		235G	242		1204G	247		1600G	253	
202G	237		236G	242		1205G	247		1601G	253	
203G	237		237G	242		1206G	247		1602G	253	
204G	237		238G	242		1207G	248		1603G	253	
205G	237		239G	242		1208G	248		1604G	253	
206G	237		600G	243		1209G	248		1605G	253	
207G	238		601G	243		1210G	248		1606G	253	
208G	238		602G	243		1211G	248		1607G	253	
209G	238		603G	243		1212G	249		1608G	254	
210G	238		604G	243		1213G	249		1609G	254	
211G	238		605G	243		1214G	249		1610G	254	
212G	239		606G	243		1215G	249		1611G	254	
213G	239		607G	243		1216G	249		1612G	254	
214G	239		608G	244		1217G	249		1613G	254	
215G	239		609G	244		1218G	250		1614G	255	
216G	239		610G	244		1219G	250		1615G	255	
217G	239		611G	244		1220G	250		1616G	255	
218G	240		612G	244		1221G	250		1617G	255	
219G	240		613G	244		1241G	250		1618G	255	
220G	240		614G	245		1242G	250		1619G	255	
221G	240		615G	245		1243G	250		1620G	255	
222G	240		616G	245		1244G	251		1621G	256	
223G	240		618G	245		1245G	251		1622G	256	
224G	240		619G	245		1246G	251		1623G	256	
225G	240		620G	245		1247G	251		1624G	256	
226G	241		622G	246		1248G	251		1625G	256	
227G	241		623G	246		1249G	251		1626G	256	
228G	241		624G	246		1250G	252		BON-2G	242	
229G	241		625G	246		1251G	252		BON-3G	242	
230G	241		626G	246		1252G	252				
231G	241		1200G	247		1253G	252				
232G	241		1201G	247		1254G	252				

LLAVES DE GORJA LATÓN

LETOIZKO GORJA GILTZAK • BRASS BIT KEYS

CLÉS À GORGES EN LAITON • CHUBBSCHLÜSSEL AUS MESSING

REF.	PAG.	PAG.	REF.	PAG.	PAG.	REF.	PAG.	PAG.	REF.	PAG.	PAG.
1G	258		15G	259		54G	307		A		
2G	258		16G	259		55G	307		ABU- 2G	309	
3G	258		17G	259		56G	307		AD- 1	261	
4G	258		19G	260		57G	307		AD- 2	261	
5G	258		21G	260		66G	308		AD- 3	261	
6G	258		23G	260		68G	308		AD- 4	261	
7G	258		24G	260		72G	308		AD- 5	261	
8G	258		25G	260		73G	308		AD- 6	261	
11G	259		51G	307		126H-60G	264		AD- 7	261	
12G	259		52G	307		126N-60G	264		AD- 8	261	
13G	259		52GPC	307		126PP-60G	264				
14G	259		53G	307							

ÍNDICE GENERAL

GENERAL INDEX

REF.	PAG.	PAG.
AD- 9	261	
AD-10	261	
AD-11	261	
AD-12	261	
AD-13	261	
AD-16	261	
AD-17	261	
AD-18	261	
AD-19	261	
AD-20	261	
AD-21	261	
AD-23	261	
AD-24	261	
AD-25	261	
AD-26	261	
AD-27	261	
AD-28	261	
AD-29	261	
AD-33T	309	
AD-44/1	262	
AD-44/2	262	
AD-44/3	262	
AD-44/4	262	
AD-44/5	262	
AD-44/6	262	
AD-46	313	
AD-47	313	
ADPLE-11	263	
ADPLE-22	263	
ADPLE-33	263	
ADPLE-44	263	
ADPLE-55	263	
AGA- 1G	264	
AGA- 2G	309	
AGA- 3G	309	
AGA- 4G	313	
AGA- 5G	309	
AGA- 6G	313	
AGA- 7G	313	
AGA- 8G	313	
AGA- 9G	313	
AKA-1PG	274	
ALE- 1G	309	
ANT-1G	274	
ANT-2G	274	
ANT-3G	274	
ANT-4G	274	
ANT-5G	274	
APEC-1G	313	
APEC-2G	314	
ARC- 1G	309	
ARC- 2G	309	
ARC- 3G	310	
ARC- 4G	310	
ARC- 5G	310	
ARC- 6G	310	
ARC- 7G	310	
ARC- 8G	310	
ARC-10G	310	
ARC-11G	310	

REF.	PAG.	PAG.
ARC-12G	310	
ARC-13G	310	
ARC-14G	310	
ARC-15G	310	
ARC-16G	310	
ARC-18PG	310	
ARC-19PG	310	
ARC-20PG	311	
ARC-21PG	311	
ARC-22PG	311	
ARC-23PG	311	
ARC-24G	311	
ARC-25G	311	
ARC-26G	310	
ARC-27PG	311	
AS- 1G	264	
AS- 2G	264	
AS- 3G	264	
AS- 4G	274	
AS- 5G	311	
AS- 6G/1	264	
AS- 6G/2	265	
ATR-1G	274	
ATR-2G	275	
ATR-2TG	275	
AYP-1G	311	

B

BE- 1G	275	
BE- 3G	275	
BE- 4G	275	
BE- 5G	275	
BE- 6G	275	
BE- 7G	275	
BE-10G	276	
BMC-1G	276	
BOD-1G	276	
BOD-2G	276	
BOD-3G	276	
BOD-4G	265	
BOD-5G	265	
BOG-1G	276	
BOG-2G	276	
BOX-1G	276	
BRI- 6L 1	265	
BRI- 6L 2	265	
BRI- 6L 7	265	
BRI- 6L 8	265	
BRI- 6L11	265	
BRI- 6L12	265	
BRI- 6L17	265	
BRI- 6L18	265	
BRI- 6L21	265	
BRI- 6L22	265	
BRI- 6L29	265	
BRI- 6L30	265	
BUR- 1G	314	

C

CAF-1G	277	
CAF-2G	277	
CER-1G	295	
CER-2G	295	
CER-3G	295	
CER-4G	295	
CHU - 1G	265	
CHU- 2G	265	
CHU- 4G	278	
CHU- 5G	278	
CI- 1G	279	
CI- 1PG	279	
CI- 2G	279	
CI- 3G	279	
CI- 4G	279	
CI- 5PG	279	
CI- 6G	279	
CI- 6PG	279	
CI- 7TG	280	
CI- 8G	280	
CI- 9PG	280	
CI-10G	279	
CI-12TG	280	
CI-13G	280	
CI-14G	280	
CLA-3G	280	
COR- 1G	280	
CR- 1G	281	
CR- 2G	281	
CR- 3G	281	
CR- 4G	281	
CR- 5G	281	
CR- 8G	281	
CR-10G	281	
CR-11G	282	
CR-12G	282	
CR-14G	282	
CR-17TG	282	
CR-18G	282	
CRN-1G	281	
CRT- 1G	277	
CRT- 2G	277	
CRT- 3G	277	
CRT- 4G	277	
CRT- 7G	277	
CRT- 8G	277	
CRT-10G	311	
CRT-11G	278	
CRT-12G	278	
CRT-13G	278	
CRT-14G	278	
CRT-15G	278	
CRT-17G	278	
CRT-18G	278	

D

DEB-12L	266	
DEK- 1G	282	

REF.	PAG.	PAG.
DMR-6-1	266	
DMR-6-1L	266	
DMR-6-2	266	
DMR-6-2L	266	
DMR-6-3	266	
DMR-6-3L	266	
DMR-6-4	266	
DMR-6-4L	266	
DMR-7-1	266	
DMR-7-2	266	
DMR-7-3	266	
DMR-7-4	266	
DUP-1G	314	
DV- 1G	283	
DV- 2G	314	
DV- 3G	283	
DV- 4G	314	
DV- 5G	283	
DV- 6G	283	
DV- 7G	283	
DV- 8G	283	
DV- 9G	283	
DV-10G	283	
DV-10G/A	314	
DV-11G	314	
DV-12G	284	
DV-13G	284	
DV-13G/A	314	
DV-14G	284	
DV-15G	284	
DV-16G	284	
DV-17G	315	
DV-18G	284	
DV-19G	284	

E

ELB-1G	284	
ELZ- 1G	284	
ELZ- 2G	266	
ELZ- 3G	266	
ELZ- 4G	285	
ELZ- 5G	267	
ELZ- 6G	267	
ELZ- 7G	285	
ER- 1G	267	
ER- 4G	267	
ER- 5G	267	
ERV-1G	285	
ERV-2G	285	
ERV-3G	285	
ERV-3G/A	315	
ES- 1G	267	
EST- 1G	285	
EST- 2G	285	
EST- 3G	285	
EST- 4G	286	
EST- 5G	286	
EST- 5TG	286	
EST- 6G	286	

REF.	PAG.	PAG.
EST- 7G	286	
EST-10G	286	
EUT-1G	286	
EUT-2G	286	
EUT-3G	287	
EZ- 1G	287	
EZ- 2G	287	
EZ- 3G	287	
EZ- 4G	287	
EZ- 5G	287	
EZ- 6G	287	
EZ- 7G	287	
EZ- 8G	287	

F

FA- 1G	267	
FA- 2G	267	
FA- 3G	267	
FA- 4G	268	
FA- 5G	268	
FA- 6G	268	
FA- 7G	268	
FAC- 1G	287	
FAC- 2G	287	
FAC- 3G	288	
FAC- 4G	288	
FCF-1G	288	
FEB-1G	288	
FEB-2G	288	
FET-1G	288	
FIC-200	290	
FIC-401G	268	
FM- 1G	288	
FM- 2G	288	
FM- 3G	289	
FM- 4G	289	
FM- 4TG	289	
FM- 5G	289	
FM- 6G	289	
FM- 7G	289	
FM- 8G	289	
FM-13G	289	
FM-14G	290	
FM-15G	290	
FM-16G	290	
FM-17G	290	
FM-20G	290	
FM-21G	290	

G

GARD-1G	290	
GIM-1TG	291	
GMG-1G	291	
GMG-2G	291	
GPS-1G	291	
GPS-2G	291	
GPZ-1G	268	
GUR-1G	268	

REF.	PAG.	PAG.
H		
HEN-1GP	268	

I

IDM-1G	291	
IDM-2G	291	
IDM-3G	292	
IDM-4G	292	
IDM-5G	292	
IS- 1G	292	
IS- 2G	292	
IS- 3G	292	
IS- 4G	292	
IS- 5G	292	
IS- 6G	293	
IT-1G	293	
IT-1TG	293	
IT-2G	293	
IT-3G	293	
IT-4G	293	

J

JW-20G	293	
JW-30G	293	
JW-40G	294	
JW-45G	294	
JW-50G	294	
JW-70G	294	
JW-90G	294	

K

KAE- 1G	294	
KAS-1G	294	
KAS-2G	294	
KAS-4G	295	
KAS-6G	295	
KRP-1G	295	
KUR-1G	295	

L

LAR-1G	269	
LAR-2G	311	
LAR-3G	311	
LASB- 1G	269	
LASB- 2G	269	
LASB- 3G	269	
LASB- 4G	269	
LIN- 2G	296	
LIN- 3G	296	

M

MAC-1G	315	
MAX-1G	315	
MAX-2G	315	
MCM- 1G	269	

REF.	PAG.	PAG.
MCM- 2G	296	
MCM- 3G	296	
MCM- 4G	269	
MCM- 5G	296	
MOI-1G	296	
MOI-2G	296	
MOI-3G	297	
MOK-1G	269	
MT- 1G	297	
MT- 2G	297	
MT- 2TG	297	
MT- 3G	297	
MT- 3PG	297	
MT- 4G	297	
MT- 5G	297	
MT- 6G	298	
MT- 6PG	298	
MT- 8G	298	
MT- 8PG	298	
MT- 9G	298	
MT- 9PG	298	
MT-10G	298	
MT-10PG	298	
MT-11G	298	
MT-14G	298	
MT-15G	299	
MT-16G	299	
MT-17PG	299	
MTL-1G	296	

O

OMC- 1G	299	
OR-0G	312	
OR-1G	312	
OR-2G	299	
OR-3G	270	
OR-4G	312	
OR-5G	312	
OR-6G	270	
OST-1G	270	
OST-2G	270	

P

PAT-1G	299	
PR- 1G	301	
PR- 2G	315	
PR- 3G	301	
PR- 4G	301	
PTN- 1G	299	
PTN- 2G	299	
PTN- 3G	300	
PTN- 4G	300	
PTN- 5G	300	
PTN- 6G	300	
PTN- 7G	300	
PTN-10G	300	
PTN-11G	300	
PTN-13G	300	

REF.	PAG.	PAG.
PTN-13TG	301	
PTN-14G	301	
PTN-15G	301	

R

REN-1G	270	
REN-2G	270	
REVI-1G	301	
REX- 1G	270	
REX- 2G	270	
RGL-1G	301	
RUB-1G	301	
RUB-2G	302	
RUB-3G	315	
RUB-4G	302	
RUB-5G	302	
RUB-6G	312	
RUB-7G	302	
RUB-8G	302	
RUB-9G	302	
RUE-2G	312	

S

SAF-1G	302	
SAF-2G	303	
SAM- 1G	303	
SAM- 2G	303	
SAM- 4G	303	
SAM- 5G	303	
SB-1PG	302	
SDR-1G	305	
SDR-2G	305	
SDR-3G	305	
SEC-1G	303	
SEC-2G	303	
SEC-3G	303	
SEC-4G	304	
SEC-7G	304	
SER-1G	315	
SIA-2G	304	
SIA-3G	304	
SIB-1G	315	
SIB-2G	304	
SIB-3G	304	
SIB-4G	304	
SIB-5G	305	
SRM-1G	304	

T

TE- 1G	270	
TE- 2G	271	
TE- 3G	271	
TEC-1G	305	
TOV-1G	306	
TR-1G	306	
TSI-1G	305	
TTN-1G	305	

ÍNDICE GENERAL

GENERAL INDEX

REF.	PAG.	PAG.
TTN-2G	305	
TUS-1G	306	
TV- 1G	271	
TV- 2G	271	
TV- 3G	271	
TV- 5G	271	
TV- 7G	271	
TV- 8G	271	
TV- 9G	271	
TV-10G	271	
TV-11G	271	
TV-12G	271	
TV-13G	272	
TV-14G	272	

REF.	PAG.	PAG.
TV-15G	272	
TV-16G	272	
TV-17G	272	
TV-18G	272	
TV-19G	272	
TV-20G	272	
TV-21G	272	
TV-22G	272	
TV-23G	272	
TV-24G	272	
TV-25G	272	
TV-26G	272	
TV-27G	272	

REF.	PAG.	PAG.
UCEM- 1G	272	
UCEM- 2G	273	
UCEM- 3G	273	
UN- 1G	273	

REF.	PAG.	PAG.
VILL-1G	312	

REF.	PAG.	PAG.
WE- 1G	306	
WE- 2G	306	
WM-1G	273	

REF.	PAG.	PAG.
YA- 1G	306	
YA- 2G	306	
YA- 3G	306	
YA- 4G	306	
YA- 5G	273	

LLAVES DE GORJA ZAMAK

ZAMAKEZKO GORJA GILTZAK • ZAMAK BIT KEYS

CLÉS À GORGES EN ZAMAK • CHUBBSCHLÜSSEL AUS ZAMAK

REF.	PAG.	PAG.
CIS-803/1	317	
CIS-803/2	317	
CIS-803/3	317	
CIS-803/4	317	

REF.	PAG.	PAG.
CIS-803/5	317	
CIS-803/6	317	

REF.	PAG.	PAG.
NEF-2Z 1	317	

REF.	PAG.	PAG.
NEF-2Z 2	317	
NEF-2Z 3	317	
NEF-2Z 4	317	
NEF-2Z 5	317	
NEF-2Z 6	317	
NEF-2Z 7	317	

REF.	PAG.	PAG.
NEF-2Z 8	317	
NEF-2Z 9	317	
NEF-2Z10	317	

LLAVES ARTÍSTICAS Y DE ARMARIO LATÓN

LETOIZKO GILTZAK: ARMAIRUETARAKO ETA ARTISTIKOAK • BRASS FURNITURE KEYS

CLÉS POUR MEUBLES EN LAITON • MÖBELSCHLÜSSEL AUS MESSING

REF.	PAG.	PAG.
A-0G	319	
A-0G(CV)	319	
A-1G	319	
A-1G(CV)	319	
A-1G/1	319	
A-1G/2	319	
A-1G/3	319	
A-1G/4	319	
A-1G/5	319	
A-1G/6	319	
A-2G	319	
A-2G(CV)	319	
A-2G/1	319	
A-3G	319	
A-3G(CV)	319	
A-4G	319	
A-5G	319	
AA-1G	320	
AA-1G(CV)	320	
AA-2G	320	
AA-2G(CV)	320	
AA-3G	320	

REF.	PAG.	PAG.
AA-3G(CV)	320	

REF.	PAG.	PAG.
B-3G	320	
B-3G(CV)	320	

REF.	PAG.	PAG.
C-3G	320	
C-3G(CV)	320	

REF.	PAG.	PAG.
D-3G	320	
D-3G(CV)	320	

REF.	PAG.	PAG.
E-0G	320	
E-0G(CV)	320	
E-1G	320	
E-1G(CV)	320	
E-2G	321	
E-2G(CV)	321	

REF.	PAG.	PAG.
E-3G	321	
E-3G(CV)	321	

REF.	PAG.	PAG.
H-3G	321	
H-3G(CV)	321	

REF.	PAG.	PAG.
I-1G	321	
I-1G NIQ	321	

REF.	PAG.	PAG.
J-1G(CV)	321	
J-2G(CV)	321	
J-3G	321	
J-3G(CV)	321	

REF.	PAG.	PAG.
L-3G	321	
L-3G(CV)	321	

REF.	PAG.	PAG.
N-1G	322	
N-1G NIQ	322	

REF.	PAG.	PAG.
U- 1G	322	
U- 1G NIQ	322	

REF.	PAG.	PAG.
V-1G	322	
V-1G(CV)	322	
V-2G	322	
V-2G(CV)	322	
V-3G	322	
V-3G(CV)	322	
V-4G(CV)	322	
V-5G(CV)	322	

LLAVES ARTÍSTICAS Y DE ARMARIO ZAMAK

ZAMAKEZKO GILTZAK: ARMAIRUETARAKO ETA ARTISTIKOAK • ZAMAK FURNITURE KEYS
CLÉS POUR MEUBLES EN ZAMAK • MOBELSCHLÜSSEL AUS ZAMAK

REF.	PAG.	PAG.	REF.	PAG.	PAG.	REF.	PAG.	PAG.	REF.	PAG.	PAG.
A			D			E			F		
A1(L)	324		D1(L)	324		E1(L)	324		F1(L)	324	
A1(N)	324		D1(N)	324		E1(N)	324		F1(N)	324	

LLAVES PARA CASILLAS Y ASCENSORES

KUTXATILA ETA IGOGAILUENTZAKO GILTZAK • LIFT AND MAIL BOX KEYS
CLÉS POUR ASCENSEURS ET BOITES A LETTRES • BRIEFKASTEN-UND LIFTSSCHLÜSSEL

REF.	PAG.	PAG.	REF.	PAG.	PAG.	REF.	PAG.	PAG.	REF.	PAG.	PAG.
A			D			U			Y		
7-S	326		AC-9	326		URKO-4	326		YA-30	326	
26-M	326		AC-12	326							
			AC-14	326							
			AC-15	326							

ÍNDICE DE MARCAS

MARKEN AURKIBIDEA

BRAND INDEX

INDEX MARQUE

HAUPTMARKE



THE KEY TO EXCELLENCE
GLOBALLY UNLOCKING MILLIONS OF DOORS DAILY

ÍNDICE DE MARCAS

MARKEN AURKIBIDEA • BRAND INDEX • INDEX MARQUE • HAUPTMARKE

MARCA- MARKA- MAIN MARQUE - MARKE	PÁG. - ORRIA - PAGE - PAGE - SEITE
45	1
126	264
303	1
333	1

A

A.M. BARAS	1
ABA	1
ABBES	78, 183
ABC	1, 2
ABLOY	2
ABSA	2, 3, 27, 101, 102, 143, 203
ABT	133
ABUS	3, 4, 5, 6, 23, 33, 34, 35, 59, 66, 71, 93, 101, 119, 133, 138, 139, 143, 309
ACE	32
ADAMSRITE	6
ADEMCO	32, 139, 218
AEP	6
AGA	6, 7, 8, 17, 27, 32, 264, 309, 313
AGB	8, 9
AGC	9, 226
AGE	9
AGUEDA	114
AGUIA	9
AGUT	9
AHRAM	9
AIZPUTE	9
AKARSAN	274
AKIRA	140, 141
AKS	144, 167, 168, 170, 171, 175, 176, 177
AL	11
ALA	226
ALDRIDGE	10
ALE	10
ALEDAL	309
ALFA	7, 10, 59
ALIANCA	10
ALLGOOD	28
ALPHA	10, 11, 32, 144
ALSO	72
ALTAY	11
ALUNORM	36
AM	90
AMARU	11
AMERICAN MOTORS	19, 72, 144, 145
AMIG	11, 12
ANA	232
ANCHOR	3, 4, 5, 6, 12
ANKE	25
ANKER	12
ANKERSLOT	12, 81
ANLO	62

MARCA- MARKA- MAIN MARQUE - MARKE	PÁG. - ORRIA - PAGE - PAGE - SEITE
ANTAR	12, 101, 102
ANTONIOLI	274
APEX	12, 13
APRI	89
ARCU	13, 43, 309, 310, 311
AREL	13
ARES	313, 314
ARFE	3, 13, 40, 100, 143, 313, 315
ARMAN	156, 161, 162, 163, 217
ARMOR	101, 203
ARMSTRONG	5, 13
ARNOU	28
AROUCA	13
ARREGUI	3, 7, 13, 27, 49, 56, 143
ARROW	13, 14
ARSENEVSK	14
ARTEB	207
ASEC	10
ASHICO	14
ASIA	14, 140, 141
ASPA	14
ASSA	14, 15, 16, 103, 114, 144, 264, 265, 274, 311
ASSA ABLOY	140
ASTRAL	33, 34
ATAL	78, 79, 129, 183
ATL	25
ATLANTIC	58
ATLAS	113
ATP	27
ATRA	69, 274, 275
AUMON	16, 39
AUNO	274
AUTOBLOCK	207
AVA-CHUBB	32
AVANGARD	16
AXA	144, 145
AXIS	34
AYPE	311
AZBE	16, 17, 136, 137
AZKOYEN	17
AZU	145

B

B+D	17
BAB	17, 18, 39, 102
BAGEM	1, 2, 18
BALTIKA	18
BANE SEKULIC	23, 24, 128
BANHAM	18
BAODEAN	18
BARCZ	19
BARIER	19
BARRO	42

ÍNDICE DE MARCAS

BRAND INDEX

MARCA - MARKA - MAIN MARQUE - MARKE	PÁG. - ORRIA - PAGE - PAGE - SEITE
BASCO	19, 145, 181
BASI	19
BASTA	19, 85, 195, 220
BATU	19, 33, 66
BAU	129
BELL	140, 141
BENCO	114
BENDIX	138, 139, 218
BERAM	133
BERRY	21, 29
BERTOLOTTI	115
BEST	20
BETA	20, 275, 276
BEY	20
BIBERING	20
BIELLE	20
BIFFAR	20, 118
BILMA	21
BIRD	57, 138
BKS	21, 57, 81, 138, 233, 234
BLAU	145, 164
BLOCK	208
BLOCTOUT	23
BLOCUS	99, 102
BLOSTER	205
BLUMA	226
BMC	276
BMH	317
BODA	21, 29, 30, 265, 276, 303
BOGATIR	276
BOINAITI	242
BOMORO	22, 132, 145, 198
BORKEY	22
BOSCH	145, 146, 198
BOULTON & PAUL	22
BOXAFE	276
BRABANTIA	22, 35, 88, 146, 149
BRAS	22
BRASIL	22
BRETER	141, 220
BRICARD	4, 22, 23, 33, 76, 81, 104, 265
BRIGGS & STRATTON	19, 145, 146, 147, 149, 157, 158, 159, 160
BRITAX	156, 185
BRUMME	23, 67
BSS	23, 24
BTV	24, 41, 42, 111, 112, 296
BUFFO	4, 5, 143
BUGA	24
BULAT	24
BULIT	3, 72
BURG	4, 5, 25, 26, 39, 67, 95, 102, 133, 147, 203, 226, 227, 314
BURG WACHTER	25, 293, 294
BURGHOWT	115
BUS	26
BUVA	25, 26
BWS	36
BY	27
BYP	12, 68

MARCA - MARKA - MAIN MARQUE - MARKE	PÁG. - ORRIA - PAGE - PAGE - SEITE
C	
C.A.R.S.	95
C.V.C.	12
CAB	27, 138, 139
CAF	277
CAM	303
CAMA	147
CAMBOA	36
CAP	27, 99
CARAT	57, 138
CARTERO	27
CAS	50
CAS CISMA	27, 90, 317
CASAS	8, 27
CASELLAS	147
CASH BOX	27, 88
CASI	106, 156, 157, 167, 168, 170, 173, 175, 176, 177
CASMA	31
CATERPILLAR	147
CATOR	102
CAVERS	17, 27, 28, 109
CAYS	28, 39, 112
CAZORLA	39
CC	115
CCF	227
CCL	38
CEM	82, 83, 147, 156, 157, 184, 185, 193, 215
CEMA	28
CENTURION	17
CENTURY	28, 29
CERRAMARC	29
CERUTTI	277, 278, 311
CES	29, 30, 31
CESSNA	147
CF	57, 299
CFP	136
CHANGE-O-MATIC	37
CHAVO	5, 31, 33, 35
CHELIABINSK	31
CHEYLOCK	32
CHG	58
CHICAGO	19, 32, 138, 139, 145, 218
CHRIST	42
CHRYSLER	147, 148, 149
CHUBB	32, 265, 278
CIB	57, 96, 99, 122
CIBC	57
CIBOX	25
CIEF	32
CIELS	32
CIFIAL	32, 33, 228
CILA GENTILI	33
CINA	14, 33, 47, 107
CISA	3, 4, 5, 33, 34, 35, 82, 128, 279, 280
CITY	27, 28, 57
CLARK FORK LIFT	35
CLASS	280
CLASSIC	35

MARCA- MARKA- MAIN MARQUE - MARKE	PÁG. - ORRIA - PAGE - PAGE - SEITE
CLAUSOR	35, 88, 148, 149, 150, 156, 157, 161, 171, 190, 191, 192, 193, 194, 195, 197, 198, 207
CLEMSA	35
CLICK	150
CLUM	150
COBRA	150
CODEM	56
CODKEY	109
COFER	87
COHNKO	35, 36
COLE HERSEE	138, 139
COLOMENCA	7
COM	36
COMBA	29, 75, 118
CORBIN	36, 37, 38, 43, 44, 45, 145, 280
CORNI	115, 281
CORONA	39, 67
CORSA	114
COTICO	39
COUILLET	101
CR	234, 281, 282
CRAIN	80
CRAZY LOCKS	39
CRC	36, 228
CROMODORA	205
CUBELLS	39
CVL	39
CWS	42

D

DACIA	150
DAD	39, 40, 41, 42, 55, 112, 130
DAELIM	151
DAEWOO	151
DAF	40
DAIHATSU	151
DAMM	21
DAR-MAR	266
DARMIK	151
DATSUN	194, 199, 200, 201
DAV	152
DC	102
DEBEAURAIN	62, 102, 122, 228, 266
DECAYEUX	39, 40, 96, 101
DEFA	40
DEHA	140, 141
DEKABA	40, 282
DELAPORTE	41
DELCA	41
DELTA	102
DERLOCHE	102
DESAL	25
DESPREZ	102
DEXTER	41, 146
DIAMOND	41
DIEBOLD	41, 326
DIFA	103
DIMITROVGRAD	41
DIRAK	41

A50

MARCA- MARKA- MAIN MARQUE - MARKE	PÁG. - ORRIA - PAGE - PAGE - SEITE
DJC	115
DNS	63
DOBLE G	152
DOBLE SAFE	82, 83, 184
DOBLINA	152
DOCO	39
DOM	36, 41, 42, 43, 44, 45, 91, 112, 152, 156, 175, 208, 217
DOMINION LOCK	13, 46
DOMUS	27, 46, 292
DONNER	114
DOOR LOCK	228
DOUBLE CIRCLE	46
DRAPER	140
DUBOIS	79, 152, 183
DUPLEX	314
DURABLE	25
DURALOCK	46
DVERNIK	283, 284, 314, 315

E

EAG	46
EAGLE	63
EAO	44
ECHO	152
ECM	46
EFER	32, 33
EIKO	47
ELBOR	284
ELCA	49, 115
ELEPHANT	120
ELFIN	28
ELMO	19, 145
ELSET	88
ELZETT	29, 47, 266, 267, 284, 285
EMGE	102
EMHART	43, 44, 45, 101, 203
EMKA	41, 47, 48
EMOH	145
ENA OQ	122
EP PINSON	47
EPO	104
EQUIBATIR	102
ERA	48, 267
EREVAN	285, 315
ERINRUDE	202
ERMEX	114
ESA	48, 267
ESAFE	32, 41, 42, 87, 112, 115, 122, 125
ESCO	5, 33, 35, 36, 37, 114
ESETY	285, 286
ESLA	48
ESS	48
ESSENDIA	5, 33, 35
ESZ	71
ETAS	48
ETNA	27, 97
EUREKA	48
EURO	39

ÍNDICE DE MARCAS

BRAND INDEX

MARCA- MARKA- MAIN MARQUE - MARKE	PÁG. - ORRIA - PAGE - PAGE - SEITE
EURO BOX	48
EURO LOCKS	19, 32, 48, 49, 82, 83, 84, 184, 185
EURONORM	36, 37
EUROP	113
EUROPARTNER	36
EURO-PRO	134
EUROPROFIL	60
EUROTEMPLE	286, 287
EVERGOOD	49, 108
EVVA	49, 50
EXCEL	50
EXPRES	50, 58, 81
EZCURRA	50, 106, 287
EZSET	76

F

FAAB	152
FAB	50, 51, 62, 153
FAC	7, 27, 51, 52, 112, 115, 132, 287, 288
FACEF	288, 292
FADE	66, 101
FAICA	153
FAINER	52
FALCON	20, 52, 135
FAMA	52, 53
FANA	23, 53
FARMA	153
FAS	53
FAS - YALE	267, 268
FASEM	20, 53
FASMA	49
FASTEX	194
FAVOUR	53
FAYN	53, 228
FB	7
FCV	53, 75
FEB	10, 32, 73, 97, 144, 288
FECHADURA	53
FECOR	39, 41, 42, 313
FEDERAL	53, 54, 57
FEFI	29
FEL	107
FEMSA	154
FERMABLOCK	95
FERMOD	39
FERONERIA	54
FETIS	288
FF	54
FH	317
FHUR	71
FIAM	228, 234, 288, 289, 290
FIAT	154
FICHET	20, 54, 55, 77, 118, 135, 268, 290
FISAM	153
FIST	55, 147, 154, 161, 204, 205
FLAMBO	44, 152
FLIETHER	75
FLIK	59
FLOHR	55

MARCA- MARKA- MAIN MARQUE - MARKE	PÁG. - ORRIA - PAGE - PAGE - SEITE
FLORA	55, 145
FO	27, 28, 92
FONTAINE	55, 102, 129
FORCE	61
FORD	154, 155, 156, 157
FORINDEX	101, 102, 203
FORT	13, 32, 55, 56, 67, 139, 145, 218
FORTE	56
FORTIS	56
FORTRESS	114
FOUR CIRCLE	140, 141
FPB	97
FRAL	97
FREA	205
FRECOV	29
FRIPA	228, 229
FROSER	2, 3, 101, 143, 203
FT	62
FTH	3, 13, 56, 57, 58, 116
FUHR	30
FULLEX	59

G

GABON	58
GAINSBOROUGH	81, 114
GALLUS	58
GAMMA	93
GAMMET	58
GARDIAN	290
GARI	7
GAS	157
GATO	58, 59
GAZ	216
GBS	136
GBZ	59
GE GE	10, 24, 59, 111
GEBA	21, 59
GEBRO	39
GEFI	5, 33, 35
GELBAU	114
GELBON	183, 184
GEM	32
GEMINI	73
GEMM	76, 77
GENERAL MOTORS	157, 158, 159, 160
GERA	59, 60, 228, 229
GERDA	60
GETE	5, 33, 35
GEVY	41
GHE	160, 161
GIBBONS	60
GIESCHE	30, 75
GIMAST	291
GIMN	101
GIOBERT	150, 161, 162, 163, 164, 205
GIPI	291
GIUSSANI	60, 61
GLAZIEV	61
GLOBE	61, 62

MARCA- MARKA- MAIN MARQUE - MARKE	PÁG. - ORRIA - PAGE - PAGE - SEITE
GLOSTAL	59
GMB	11
GMG	291
GOLD DOOR	61, 62
GOLLOT	102
GOTZ	75
GOYAL	7
GPZ	268
GR	62
GRAF	75
GRAYHILL	68
GRUNDMANN	59
GSA	27
GTV	5, 33, 35, 62, 71
GUARD	62, 66
GUARDIAN	27, 54, 268
GUERVILLE R.	62, 63
GUIDOTTI	102
GUITTEL	4, 5, 107
GUTLER	107

H

HÄFELE	29, 31, 41, 42, 63, 78, 79, 183
HAGA	63
HAIDE	140, 141
HAMA	164
HANNO	29
HARKOV	63
HARLEY DAV.	164
HARLOC	63, 114
HASLER	106
HB	64
HBC	89
HEAD	140, 141
HECTOR	64
HEGO	36
HEKNA	41, 42, 45, 64
HELCO-KFV	229
HELIX	64
HEMA	129
HEMY	140, 141
HENDERSON	64, 268
HERACLES	57
HERME	64
HERMES	140, 141
HERO	94
HERPE	114
HERSEE	19, 145
HESTE	36
HEWY	25
HILLMANN	116
HINO	214
HK	145
HOBES	64
HOHRMANN	21, 29, 30, 42, 59
HONDA	164, 165, 166, 167
HOPPE	25
HORSE	64
HRG	95

MARCA- MARKA- MAIN MARQUE - MARKE	PÁG. - ORRIA - PAGE - PAGE - SEITE
HSA	75
HTEC	65
HTV	65, 107
HUDSON	65, 167
HUF	154, 156, 167, 168, 169, 170, 171, 172, 173, 174, 175, 176, 177
HUTRA	106
HUWIL	41, 42, 65, 177
HYUNDAI	177, 178, 179

I

I.R.	137
IACAM	162
IBEAR	65
ICA	65
ICSA	65, 80
IDEAL	42
IDEAL SECURITY	135
IDM	291, 292
IFAM	17, 38, 57, 65, 66, 67, 68, 112
IFOS	115
IGS	67
IKON	39, 67
ILARGI	28, 67
ILCO	67, 68
ILLINOIS	19, 32, 68, 139, 145, 218
IMB	68
IMBAC	100
IMP	3, 4, 5
IMSA	173, 179, 180, 205
INCECA	68
INDAK	210
INDAUX	13
INGERSOLL	68
INLOC	23
INSTALL	115
INT	68
IR	68
ISEO	28, 69, 98, 122, 129, 215, 229, 290, 292, 293
ISKU	95
ISSERSTEDT	36
ISUZU	180
ITAL	293
ITEM	26
ITO	5, 33, 35, 69
IVANA	70

J

JARDI	70
JD	10, 102, 144
JET	3
JINLONG	70
JIP	70, 99, 101, 102
JIS	70, 71, 74
JJ	39
JL	57
JMP	3, 6
JOMA	27, 65, 66, 71, 108
JOE	136

ÍNDICE DE MARCAS

BRAND INDEX

MARCA- MARKA- MAIN MARQUE - MARKE	PÁG. - ORRIA - PAGE - PAGE - SEITE
JOSTA	29
JOVI	7, 71
JOWIL	62, 71
JPM	3, 33, 71, 72, 75
JTF	72
JU	79, 130, 183
JU JUNGINGER	72
JUGODENT	156
JUNGHEINRICH	72
JUNGST	71
JUNIE	72
JUNKUNC	72
JUWEL	293, 294
JUZU	72
JVAL	73

K

K+K	87
KABA	73
KALE	3, 73, 74, 294
KALUGA	74
KAMAZ	180
KAP	74
KARDEX	29, 101, 203
KARO	57
KASSEL	294, 295
KATE	107
KAWASAKI	181
KAWE	36, 37, 114, 135
KAZAN	74, 75
KEMEN	7, 94, 95
KENWORTH	181
KERBEROS	295
KESO	75
KEYA	3, 143
KFV	75
KIA	181, 182
KICHINEV	75
KIFER	7
KIFERM	75, 78, 79, 101, 148, 183, 202
KIMA	30
KIND	25, 29
KIROVMACH	75
KITTY	2
KLIT	129, 215
KN	145
KNAPP	29
KOLB	146, 154, 156, 157
KP	75
KRAMATORSK	76
KREMENCHUG	76
KREPISH	295
KRESTI	229, 230, 231
KROST	26
KUNERT	33
KURZEME	295
KVR	27
KWIKSET	76
KYMCO	182
KYNNARPS	76

MARCA- MARKA- MAIN MARQUE - MARKE	PÁG. - ORRIA - PAGE - PAGE - SEITE
--------------------------------------	------------------------------------

KYR	106
-----	-----

L

LABOFA	59
LADA BAKONY	182, 183
LAFONTE	76
LAGRANDE	68
LAMA	89, 117
LAMPA	28
LANE	38
LAPERCHE	27, 76, 77, 101, 102, 129
LAPORTE	22, 78, 145, 203
LAR	269, 311
LAREDO	57, 138
LARK	61, 78
LAS	78, 79, 101, 183
LASBOLAGET	73, 79, 107, 269
LEFEBURU	32
LEGALLAIS	64
LEGGI	79
LEN-LOK	82
LG	13
LINCE	10, 79, 80, 144, 296
LINDE	145
LION	72
LIONA LIOX	102
LIPS	80, 99
LISTA	42
LITTO	12, 36, 81
LM	114
LMP	183, 184
LOB	81, 87
LOCK	81
LOCK-IT	232
LOCKSYS	109
LOCKWOOD	81, 82
LOGO	82, 128
LORI	63
LOTUS	140, 141
LOWE & FLETCHER	32, 49, 82, 83, 84, 184, 185, 186
LUCKY	85
LUCO	62
LUMA	85
LUME	60
LUXOR	115
LYF	85

M

M.LUNA	2, 143
MACOR	315
MAFOR	102, 232
MAGNETI MARELLI	161, 204, 205, 207
MARCADET	78, 183
MARIANI	85
MARK	119
MARQUES	85
MARUTI	186
MASTER	36, 85, 86

MARCA- MARKA- MAIN MARQUE - MARKE	PÁG. - ORRIA - PAGE - PAGE - SEITE
MASTER LOCK	86
MASTERCRAFT	114
MATTEY	113
MAUER	40
MAUSER	29
MAXIGARD	58
MAXIM	315
MAZDA	186, 187, 188
MBB	29
MCL	86
MCM	86, 87, 88, 269, 296
MD	69
ME FA	88
MECALUX	7, 41, 42
MECO	88
MELSMETALL	25, 88, 89
MENOVA	42
MERCUR	71
MERCURY	150
MERIT LINDE	188
MERMIER	36, 38
MERONI	89
METAL	89, 95, 296
METALCASTELLI	64, 99
METALCHIMEX	115
METALUX	90, 115, 129
METEOR	21, 41, 42, 79, 90, 183
METIZ	90
METTEM	284
MG MONTI	90
MIA	303
MIAN	61
MIBRA	82, 83, 185
MICHEL SEAT	90, 96
MIGNON	138
MILA	90
MILES	90, 91
MING TAY	91
MINI MOLA	232
MIRAGLIO	205
MITSUBISHI	188, 189, 190
MIWA	91
MLM	41, 42, 91, 101, 112, 203
MOBELLA	91
MODERN	129
MOFLEX	95
MOGILEV	92
MOIA	296, 297
MON	92
MONACOR	10, 144
MONDIAL	62, 63, 102
MONOBLOC	28, 92
MOREAUX	42, 44, 102, 134, 232
MOSKVA	269
MOSKVITCH	190
MOSRENTGUEN	92
MOTTURA	92, 297, 298, 299
MP PLODARI	92
MR	114

MARCA- MARKA- MAIN MARQUE - MARKE	PÁG. - ORRIA - PAGE - PAGE - SEITE
MSM	93
MST	27
MSV	93, 232
MUKRA	36, 37
MULTLOCK	93

N

NABOB	232
NB	5, 33, 35, 55
ND	122
NEIMAN	145, 146, 148, 156, 157, 161, 162, 169, 175, 177, 190, 191, 192, 193, 194, 195, 196, 197, 198, 199, 205, 206, 207, 215
NEMEF	29, 30, 31, 36, 101, 203, 232, 317
NEWMAN TONKS	114
NICO	57, 75
NISSAN	199, 200, 201, 202
NOBO	42, 45, 152
NORDWEST	55, 106
NOVA	93, 119
NOVOFERM	36
NUMIDA	48
NUMIDIA	102

O

OAL	38, 60
OCARIZ	93
OCTAVO M.	93
ODA	12, 32
OFITA	94
OIAUS	8
OJMAR	29, 94, 95
OLIVA	95
OLIVETTI	95
OMA	95
OMEC	95, 96, 299
OMIV	20, 96
OMR	90, 96
ONIUM	124
ORBA	107
ORDO	78, 96, 183
ORENGO	7, 270, 299, 312
ORION	114
ORION NOVOX	96
ORO	96
ORONA	224
ORSHA	96
OSKO	71
OSTMARK	270
OTIS	67, 68

P

P&C I.	96
PADO	96, 97
PANTHER	71
PAPAIZ	97, 233
PAS	99

ÍNDICE DE MARCAS

BRAND INDEX

MARCA- MARKA- MAIN MARQUE - MARKE	PÁG. - ORRIA - PAGE - PAGE - SEITE
PASSY	101
PASTORE	99
PATRONE	299
PAYKAN	116
PB	95
PC	20, 73, 97
PEBRA	168
PENT	122
PENZMASH	97, 98
PEROHAUS	45, 59, 72, 160
PERRIER	62
PETERBORO	46
PETROZAVODSK	98
PFÄFFENHAIN	98
PGO	202
PH	122
PHILLIPS	22, 98
PHOENIX	98
PICARD	20, 98
PICARDIE	58, 117
PJ	79, 101, 147, 148, 183, 202, 203
PK	79, 183
PLUS	5
PM	101, 102
POLAR	146
POLLAK	202
POLLUX	99
POS	145, 160, 203
POTENT	90, 99, 299, 300, 301
PP	39
PRAZIS	234
PREFER	95, 99, 100, 301, 315
PREMI	89
PRESTA	22, 145, 203
PROAUTO	143
PROBAT	57
PROGRES	55
PROMO	99
PROTEC	27
PZ	21

Q

QCM	39, 122
QCP	27

R

RADIAL	130, 131
RAM	140, 141
RAUCO	64
REDY	81
REGAL	100
REGENT	64
RENAG	270
RENZ	41, 42, 78, 79, 100, 183
REVI	301
REX	100, 270
RGM	100
RIAZIAN	100

MARCA- MARKA- MAIN MARQUE - MARKE	PÁG. - ORRIA - PAGE - PAGE - SEITE
RICOUARD	101
RIGA	101
RIGAL	301
RIL	101, 326
RIPA	66, 101
RITA	101
RITTAL	25, 26
RIV	122
ROC	57, 138
RONEO	7, 101, 132, 203
RONIS	76, 77, 78, 101, 102, 183, 203, 204, 232
ROOL A DOOR	17
ROOTES	185
ROS	183, 184
ROSS	147, 148, 204
ROSSETTI	103
ROTO	25, 60
ROYAL	4, 5, 103, 133, 140, 141
RS	94
RST	22
RUBEN	301, 302, 312, 315
RUE	312
RUFFINI	205
RUKA	41, 42, 130
RUKO	103
RUSSIA	104
RUSSWIN	104
RUTALCHI	7

S

SAAB	204
SAB.	302
SABT	104
SADV	24, 101, 102, 203
SAFE	164, 179, 180, 204, 205, 207, 302, 303
SAG	286, 291, 292
SAM	104, 303
SAMSONITE	104
SANCHUN	140, 141
SANEL	101, 203
SANPEUR	131
SANTIS	29
SANTOS	95, 97
SANY	10, 144
SARGENT	104, 105
SATURN	19, 105
SCHAFFER	101, 203
SCHARER	105
SCHLAGE	17, 105, 106
SCHLECHTENDAHL	106
SCHLEGEL	41, 42
SCHRITT	67
SCHUCO	3, 5, 33, 35, 75, 106
SCOVILL	17
SCUDO	8, 9
SE	62, 114
SEA	106
SECURE	110
SECUREMME	106, 303, 304

MARCA- MARKA- MAIN MARQUE - MARKE	PÁG. - ORRIA - PAGE - PAGE - SEITE
SECURIKEY	48, 89
SECURITAL	106
SEEBURG	68
SEIMA	183, 184
SELECT	106
SELIVANOVSK	106
SEMEL	70, 111
SEN	75
SERMEC	304
SERRALLER	7, 8, 39, 65, 112, 315
SERRETA	107, 326
SES	115
SESA	101, 102
SEZAN	140, 141
SHANGAI	107
SHAW	107
SHILUTE	107
SHOWA	104
SIAM	27, 107
SIAS	304
SIB	27, 80
SIBI	304, 305, 315
SIDERAL	305
SIDLEEN	50
SIEBAU	30, 118
SIL	52, 108, 125
SIMATIC	107
SIMECA	60, 107
SIMPLEX	102, 203, 205, 206, 215
SINJET	42
SIPEA	161, 162, 163, 204, 205, 207
SIS	107, 108
SISO	27, 95, 108
SISPA	203, 207
SJL	108
SKILMANN	37
SOFER	108
SOFI SONAFI	108
SOLER	108
SOLID	29, 30
SOLOR	102
SONICO	35, 36
SOPRANO	108
SOS	27, 58, 109, 115, 232
SP	58
SPEEDAL	31
SPIDER	109
SQUIRE & S.	109, 110
SS	29, 30
STA LOCK	110
STAM	53
STANDARD	5, 33, 35
STAR	110
STARLET	110
STEELCASE	32, 65, 177
STEIGA	42
STEKLOMASH	110
STEM	111
STIQAM	27, 122

MARCA- MARKA- MAIN MARQUE - MARKE	PÁG. - ORRIA - PAGE - PAGE - SEITE
STRAFOR	65, 101, 102, 177, 183, 203
STRATTEC	155
STREBOR	111, 184, 207
STREMLER	22, 27, 36, 102, 129
STS	27, 41, 42, 45, 111, 112, 115, 208
STUBLINA	112
STUMPF	95, 112
STUMPF METALL	95
STUV	29, 30, 42, 91, 102, 112, 113
STV	96
SUBARU	208
SUF	57
SUKI	55
SUL	36
SUREX	113
SURFINOR	54, 55
SUYOKA	7
SUZUKI	208, 209
SWAN	140, 141
SWEDA	99

T

TAITO	113
TALLINN	113
TANLOCKS	79
TAP-AGIS	210
TARONI	114
TAS	20
TATA	210
TAYLOR	114
TAYMOR	114
TECHNAL	114
TECNO	65, 177
TECNOLAR	112
TECNOR	55
TECSESA	112, 114, 305
TECUMSEH	210
TEICOCIL	53, 114, 119
TEKA	14, 114
TELFORD	82, 184
TEM	66, 114
TERCA	7
TESA	3, 66, 69, 114, 115, 133, 226, 227, 270, 271
TESIO	305
TESTA	27
TH	115
THOMAS LAIDLAW	115
THONE	36
THT	65
TIBBE	169, 210
TICINO	115
TIEFENTHAL	47, 62, 71
TIFON	116
TIGRIS	116
TITAN	76, 116, 117, 210
TITANO	305
TITUS	137
T-KEY	113
TM	42

ÍNDICE DE MARCAS

BRAND INDEX

MARCA- MARKA- MAIN MARQUE - MARKE	PÁG. - ORRIA - PAGE - PAGE - SEITE
TOK WINKHAUS	20, 117, 118, 217
TOKAJ RIKA	160, 210, 211, 212, 213, 214
TOMSK	118
TOP	93, 119
TOPLOCK	115
TOVER	19, 56, 119, 306
TOYOTA	210, 211, 212, 213, 214
TR	306
TRAMA	204, 205
TRAVEX	119
TREE	35
TRELOCK	117, 118, 119, 130, 214, 217
TRI CIRCLE	46, 119, 120
TRI STAR	120
TRINITY	90
TRIO	121
TRIO-VING	120, 121, 226, 271, 272
TRITON	29, 71
TROMER	87, 119
TRUMPH	115
TRW-SIPEA	214
TRYBA	49
TSAG	121
TUFF	233
TULA	121
TURSCHLOSS	20
TUSHINO	121, 306
TUTIS	47
TZAFRER	33, 59, 121

U

UBE	167, 168, 170, 175, 176, 177
UCEM	39, 122, 132, 272, 273
ULIANOVSK	122, 123
ULTRA	83, 185
UMF	123
UNIFOR	99
UNION	82, 83, 123, 124, 184, 185, 207, 214, 215, 273
UNIPART	217
UNIVERSAL	124, 125, 126, 127, 128, 233
URBIS	128
URKO	128, 129, 326
US	72
UTZ	82, 83, 107, 185

V

VACHETTE	69, 76, 77, 116, 118, 129, 130, 131, 132, 205, 206, 215, 216, 317
VAGO	99
VALEO	198, 199, 201, 216
VARIOS	132
VAUGHN	65, 107
VBH	132
VDO	171
VEGA	12, 102, 132
VELO	140, 141
VENDI	132, 133
VENLOCK	114

MARCA- MARKA- MAIN MARQUE - MARKE	PÁG. - ORRIA - PAGE - PAGE - SEITE
VERSCO	36
VG F VILLATORE	133
VIDMAR	106
VIKI	42
VILLFER	312
VINCO	129, 130
VING	133
VIP	27
VIRO	2, 133, 134, 220
VISO	140, 141
VISONIC	10, 144
VOKO	29, 71
VOLGA	216, 217
VOLGOGRAD	134
VOLKOVYSK	134

W

WALE	137
WALLY	134
WALRUS	134
WASO	29, 145, 156, 199, 200, 201, 217
WEBER	135
WEBSTER	135
WECO	21, 29, 135, 138, 160
WEISER	52, 135
WELKA	135, 306
WEPA	71
WESCO	145
WESLOCK	135
WEST LOCK	135, 218
WIGRO	136
WILKA	136
WILLENHALL	60
WILMOT BREEDEN	185, 186
WINFIELD	140, 141
WINKHAUS	136, 137
WINNER	58, 62
WIREROPE	137
WITTE	167, 168, 169, 170, 175, 176, 177, 218
WMS	137, 273
WOC	57, 138
WSM	25

Y

YAC	101, 203
YALE	19, 21, 57, 107, 137, 138, 139, 140, 145, 147, 148, 149, 218, 233, 234, 273, 306, 326
YALTRES	22, 56
YAMAHA	218, 219, 220
YANEDIS	48
YARDENI	140
YEMAR	115, 122
YETI	81, 87, 140, 141
YMOS	156, 157, 161, 169, 171, 172, 173, 174, 175, 196, 197, 204
YUGO	220
YVEL	101, 152

MARCA- MARKA- MAIN
MARQUE - MARKE

PÁG. - ORRIA - PAGE - PAGE - SEITE

Z

ZADI	141, 220, 221
ZAIN	16, 17
ZANI	65
ZAZ	216
ZECE	36

MARCA- MARKA- MAIN
MARQUE - MARKE

PÁG. - ORRIA - PAGE - PAGE - SEITE

ZEISS IKON	234, 235
ZENI	28, 141
ZENICA	27, 28
ZENITH	28, 107
ZIL	180, 221

AUTOMÓVIL / CAMIONETA

AUTOMOBILA/KAMIONETA • CAR-PICK UP
VOITURE-CAMIONNETTE • AUTO-KLEINTRANSPORTER

MARCA- MARKA- MAIN
MARQUE - MARKE

PÁG. - ORRIA - PAGE - PAGE - SEITE

A

ABT	329
ACM	329
ACURA (HONDA)	329
ALFA ROMEO	329, 330
AMERICAN MOTORS	330
ARO DACIA	330
ASTON MARTIN	330
AUDI	330, 331
AUSTIN	331
AUTOBIANCHI	331

B

BEDFORD	331
BENTLEY	331
BERTONE	331
BMA	331
BMW	331

C

CARBODIES	331
CHRYSLER	332
CHRYSLER (DODGE)	332
CHRYSLER (EAGLE)	332
CHRYSLER (PLYMOUTH)	332
CITROEN	332, 333

D

DAEWOO	333, 334
DAF	334
DAIHATSU	334
DAIMLER	334
DE LOREAN	334
DELTA MOTOR	334
DISALCAR	334

MARCA- MARKA- MAIN
MARQUE - MARKE

PÁG. - ORRIA - PAGE - PAGE - SEITE

E

EBRO	334
------	-----

F

FERRARI	334
FIAT	334, 335, 336
FIAT (ARGENTINA)	336
FIAT (BRASIL)	336
FIAT (TURQUIA)	336
FIAT IVECO	336, 337
FORD	337, 338
FORD (ARGENTINA)	338
FORD (AUSTRALIA)	338
FORD (BRASIL)	338
FORD (SOUTH AFRICA)	338
FORD (USA)	338, 339
FORD (USA) (LINCOLN)	339
FORD (USA) (MERCURY)	339
FREIGHTLINER	339

G

GM (BUICK)	339, 340
GM (CADILLAC)	340, 341
GM (CHEVROLET BRA.)	341
GM (CHEVROLET)	341, 342
GM (GEO)	342
GM (GMC)	342, 343
GM (OLDS MOBILE)	343, 344
GM (PONTIAC)	344
GM (SATURN)	344

H

HAMOMAG HENSCHEL	344
HOLDEN	344, 345
HONDA	345
HYUNDAI	345

ÍNDICE DE MARCAS

BRAND INDEX

MARCA - MARKA - MAIN MARQUE - MARKE	PÁG. - ORRIA - PAGE - PAGE - SEITE
--	------------------------------------

I

INFINITI (NISSAN)	345
INNOCENTI	345, 346
INTER. HARVESTER	346
IRMSCHER	346
ISUZU	346

J

JAGUAR	346
JEEP	346
JENSEN	346

K

KENWORTH	346
KIA	346, 347

L

LA FORZA	347
LADA VAZ	347
LAMBORGHINI	347
LANCIA	347
LAND-RANGE ROVER	347, 348
LEXUS (TOYOTA)	348
LOTUS	348

M

MACK	348
MARUTI	348
MASERATI	348
MAZDA	348, 349
MERCEDES	349, 350
MG	350
mitsubishi	350, 351
MOSKVITCH	351

N

NISSAN	351, 352
NISSAN (AUSTRALIA)	352
NISSAN (USA)	352

O

OM IVECO	352
OPEL-VAUXHALL	352, 353

P

PEUGEOT	353
PEUGEOT (ARGEN.)	353, 354
PIAGGIO	354
PORSCHE	354
PREMIER	354

MARCA - MARKA - MAIN MARQUE - MARKE	PÁG. - ORRIA - PAGE - PAGE - SEITE
--	------------------------------------

R

RAYTON FISSORE	354
RENAULT	354, 355
RENAULT (ARGEN.)	355
RENAULT SAVIEM	355, 356
ROLLS ROYCE	356
ROVER	356

S

SAAB	356, 357
SEAT	357
SKODA	357
SSANGYONG	357
STERLING	357
STEYR-PUCH	357, 358
SUBARU	358
SULKY	358
SUNBEAM	358
SUZUKI	358

T

TALBOT SIMCA	358, 359
TATA	359
TOYOTA	359, 360
TRABANT	360
TRIUMPH	360

U

UAZ	360
-----	-----

V

VAUXHALL	360
VOLGA	360
VOLKSWAGEN	361
VOLKSWAGEN (ARGEN.)	361
VOLKSWAGEN (BRASIL)	361, 362
VOLKSWAGEN (CHINA)	362
VOLKSWAGEN (MEXICO)	362
VOLVO	362

W

WARTBURG	362
----------	-----

Y

YUGO-ZASTAVA	362, 363
--------------	----------

Z

ZAZ	363
-----	-----

CAMIÓN

KAMIOIA • TRUCKS • CAMION • LKW

MARCA - MARKA - MAIN
MARQUE - MARKE

PÁG. - ORRIA - PAGE - PAGE - SEITE

A

ASTRA 367

B

BEDFORD 367

BROCKWAY 367

D

DAF 367

DIAMOND REO 367

F

FIAT IVECO 367, 368

FORD 368

FORD (USA) 368, 369

FREIGHTLINER 369

G

GM (CHEVROLET) 369

GM (GMC) 369

H

HINO 369

I

ISUZU 369

K

KENWORTH 369

M

MACK 369

MAGIRUS DEUTZ 369

MAN 369

MERCEDES (ARGENTINA) 369

mitsubishi 369

N

NISSAN 369

P

PEGASO 369, 370

PIAGGIO 370

A60

MARCA - MARKA - MAIN
MARQUE - MARKE

PÁG. - ORRIA - PAGE - PAGE - SEITE

R

RENAULT SAVIEM 370

ROVER 370

S

SCANIA 370

STEYR PUCH 370, 371

T

TRUCK (USA) 371

V

VOLKSWAGEN 371

VOLVO 371

W

WHITE 371

ÍNDICE DE MARCAS

BRAND INDEX

MOTOCICLETA

MOTOZIKLETA • MOTORCYCLE • MOTOCYCLETTE • MOTORRAD

MARCA- MARKA- MAIN
MARQUE - MARKE

PÁG. - ORRIA - PAGE - PAGE - SEITE

A

APRILIA	375
ATALA	375

B

BENELLI	375
BETA	375
BICICLETTA-CYCLES	375, 376
BIMOTA	376
BMA	376
BMW	376

C

CAGIVA	376, 377
CIMATTI	377

D

DEMM	377
DERBY	377
DKM-HERCULES	377
DUCATI	377

F

FANTIC MOTOR	377, 378
--------------	----------

G

GARELLI	378
GILERA	378, 379

H

HARLEY DAVIDSON	379
HERCULES	379
HONDA	379, 380, 381

I

ITALJET	381
---------	-----

K

KAWASAKI	381, 382, 383
KTM	383
KYMCO	383

L

LAMBRETTA	383
LAVERDA	383
LINCE	383

MARCA- MARKA- MAIN
MARQUE - MARKE

PÁG. - ORRIA - PAGE - PAGE - SEITE

M

MAICO	383
MALAGUTI	383
MALANCA	383, 384
MBK	384
MBM	384
MONTESA	384
MORINI FRANCO	384
MOTO GUZZI	384, 385
MOTO MORINI	385
MOTOBECANE	385
MOTOBI	385
MOTRON	385
MV AUGUSTA	385
MZ	385

N

NORTON	385
--------	-----

O

OMC	385
OSSA	385

P

PERIPOLI	385
PEUGEOT	385
PGO	386
PIAGGIO	386

R

RALEIGH	386
RIZZATO	386

S

SULKI	386
SUZUKI	386, 387
SWM	387, 388

T

TESTI	388
TRIUMPH	388

Y

YAMAHA	388, 389, 390
--------	---------------

LLAVES PLANAS PARA CERRADURAS DE CILINDRO

SARRAILA ZILINDRIKOTARAKO GILTZA ZAPALAK

CYLINDER KEYS







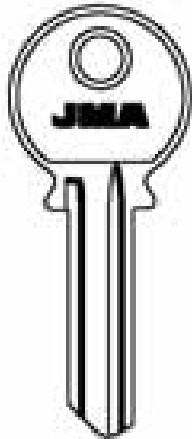
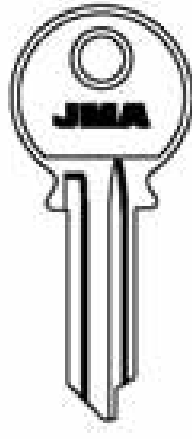
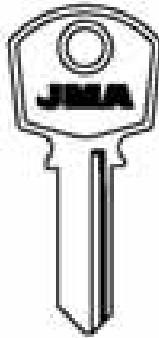
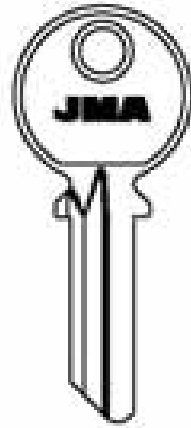

CLÉS POUR CYLINDRES

ZYLINDERSCHIÜSSEL









THE KEY TO EXCELLENCE



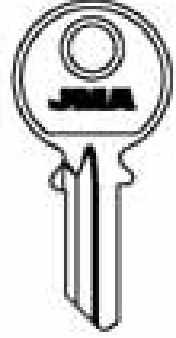
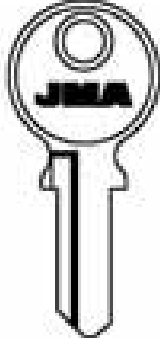
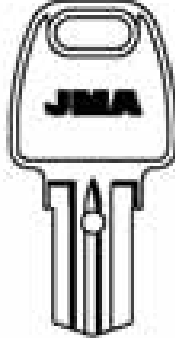
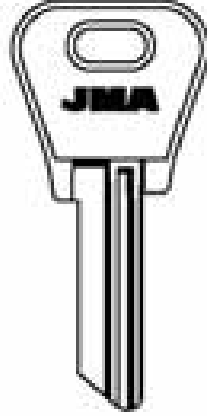
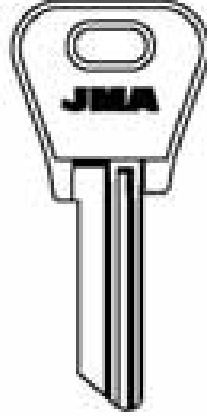



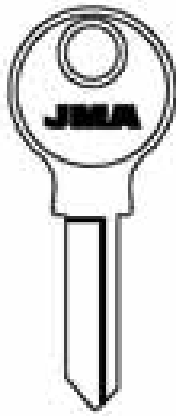

GLOBALLY UNLOCKING MILLIONS OF DOORS DAILY

PARA: FOR:	45	303	333
			
			
45-1	45-1D	45-2	45-2D
			
		303-1	303-1D
			
			333-1D

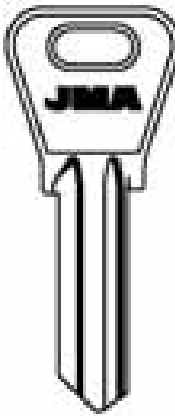
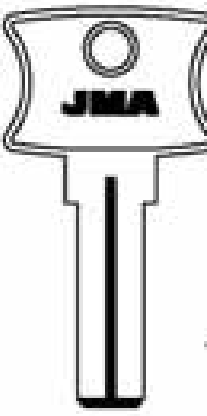
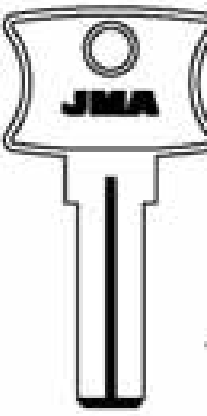
PARA-FOR:

- 45 (RUS)
- 303 (RC)
- 333 (IL)
- A.M. BARAS (GB)
- ABA (SF)
- ABC (E)

PARA: FOR:	333	A.M. BARAS	ABA	ABC
				
				
333-2D	AMB-1	AMB-1D	ABA-1	ABC-1
				11A
				BACEN

PARA: FOR:	ABC			
				
				
ABC-2	ABC-3D	ABC-5I	ABC-5D	ABC-6
				BACEN
				BACEN

Copyright by
Alejandro Allina S.A.
2010

JMA

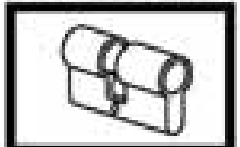

1

PARA-FOR:

- ABC (E)
- ABLOY (SF)
- ABSA (E)

<p>PARA-FOR: ABC</p> <p>ALP.</p> <p>ABC-7</p> <p>BAGEM</p>	<p>PARA-FOR: ABLOY</p> <p>LAT. ACE.</p> <p>ABLOY-1</p> <p>KITTY-VIBO</p>	<p>PARA-FOR: ABLOY</p> <p>LAT.</p> <p>ABL-3</p> <p>ABL-4</p> <p>RAB</p> <p>ABL-6</p>
---	---	---

<p>PARA-FOR: ABLOY</p> <p>LAT.</p> <p>ABL-5</p>	<p>PARA-FOR: ABSA</p> <p>AB-11</p> <p>AB-1D</p> <p>AB-21</p> <p>AB-2D</p> <p>M.LUNA</p>	<p>PARA-FOR: ABSA</p> <p>SAM.</p> <p>AB-1T</p> <p>AB-2T</p>
--	--	--

<p>PARA-FOR: ABSA</p> <p>AB-31</p> <p>M.LUNA</p>	<p>PARA-FOR: ABSA</p> <p>AB-3T</p>	<p>PARA-FOR: ABSA</p> <p>AB-4T</p>	<p>PARA-FOR: ABSA</p> <p>AB-51</p> <p>AB-5D</p> <p>FRIGER</p>
---	---	---	--

Copyright by
Alejandro Luna S.A.
2018

2

PARA:
FOR:

ABSA

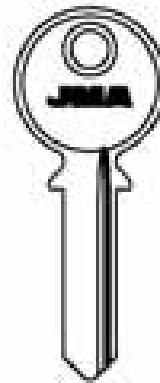
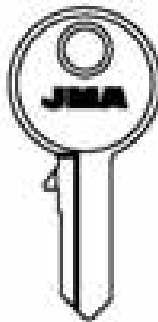
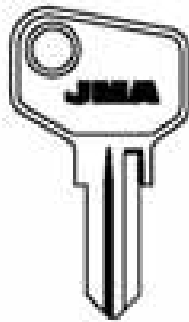

15
AB-61 AB-6D
PROAUTO



14 15
AB-81 AB-8D
ABRIGOS
ABPE-FROGER-KEYA



AB-9D

AB-11

KEYA

PARA-FOR:

ABSA (E)

ABUS (D)

PARA:
FOR:

ABUS



ABU-1
YEL
ABU-21

ABU-44

ABU-46

ABU-48D

YI
ABU-1D

YEL
ABU-2D

YEL
ABU-53

YEL
ABU-55

YEL
ABU-67

ABU-49

ABU-52D

YEL
ABU-55D

YEL
ABU-67D

YEL
ABU-71D

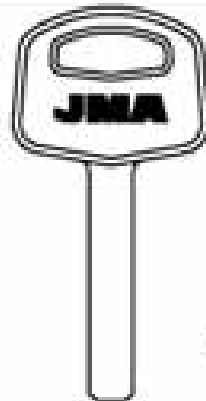

MIT.



GRANT

ABU-3

BULIT

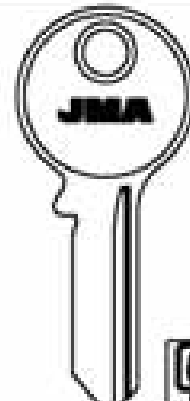

ABU-41 ABU-4D

ABU-15 ABU-15D

ANCHOR-JET-JMP-KALE-TESA

ABU-14

ABU-43D

ABU-69

CISA-JPM-SCHUCO

PARA:
FOR:

ABUS

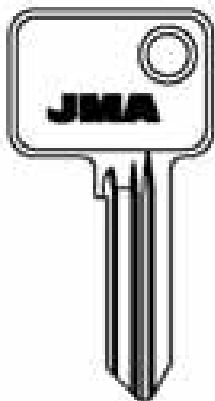

ABU-5D



ABU-81

ABU-121

ABU-8D

ABU-12D

ABU-20

ABU-47

ANCHOR-PTS-IMP

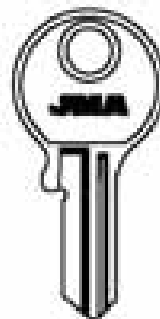

ABU-91

ABU-9D



ABU-101 ABU-10D



ABU-37D

Copyright by
Allegre Almas S.A.
2010

JMA

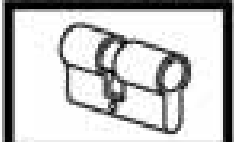

3

PARA-FOR:

ABUS (D)

PARA-FOR: **ABUS**

ABU-11 ABU-11D
CISA

ABU-13 ABU-13D
ABU-21
ANCHOR-BURG
COTTTEL-IMP-ROYAL

ABU-16
EXTRA CLAVE
CISA-BICCARD

ABU-17 ABU-17D
LAT.
ABU-45
ABU-58D
ABU-70
CISA

PARA-FOR: **ABUS**

ABU-18.P ABU-18D.P
SUPPO

ABU-19D ABU-19.P ABU-19D.P
SUPPO

ABU-22D

PARA-FOR: **ABUS**

ABU-23D
CISA

ABU-24D

ABU-25D

ABU-26D

Copyright by
Algodora Alliana S.A.
2018

JMA

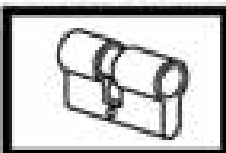

4

PARA:
FOR:

ABUS

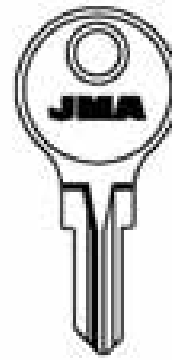
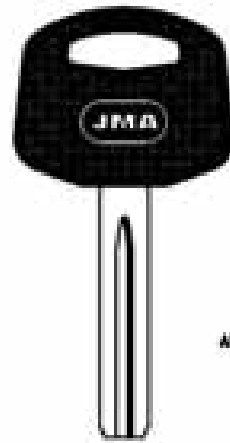
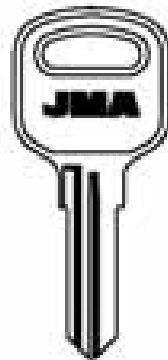

ABU-27 ABU-27D

CISA

ABU-28

ARMSTRONG-BUFFO

ABU-29.P

FLIS

ABU-30 ABU-30D

ALP.

PARA:
FOR:

ABUS

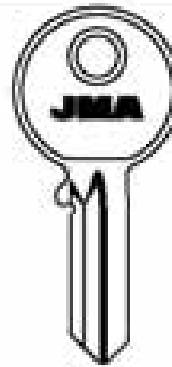
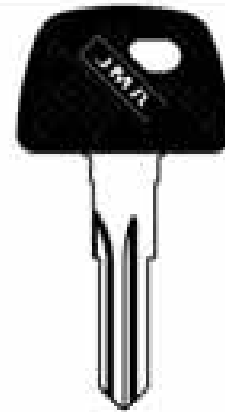
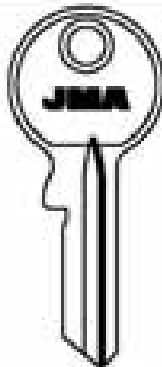

ABU-32D

ANCHOR-IMP

LIT.

EC 76

ABU-34

ABU-35.P ABU-36.P

BUFFO



ABU-38D

PARA:
FOR:

ABUS

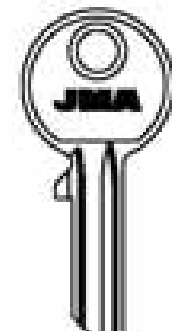
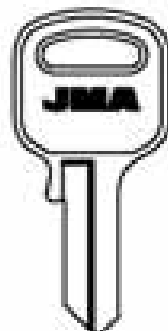
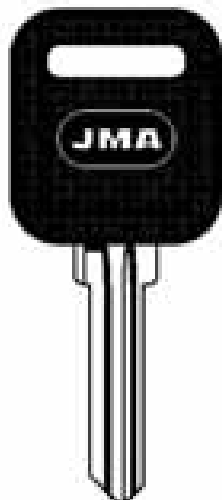

ABU-45 ABU-40
ANCHOR-BURG-GUTTEL
IMP-ROYAL

ABU-41 ABU-41D

ABU-66

ABU-42 ABU-42D

BUFFO-CISA

CISA
CISA
ESCO
ESSENZIA
ITO
GEP
GITE
GTY
HS
SCHUCO
STANDARD

PARA-FOR:

ABUS (D)

Copyright by
Allegre Almas S.A.
2010

JMA



5

PARA-FOR:



ABUS (D)

**ADAMSRITE
(GB)**

AEP (RUS)

AGA (E)

PARA-FOR: **ABUS**

ABU-60 **ABU-50** **ABU-51D** **ABU-54** **ABU-54D** **ABU-57D**

ANCHOR-JEP

PARA-FOR: **ABUS**

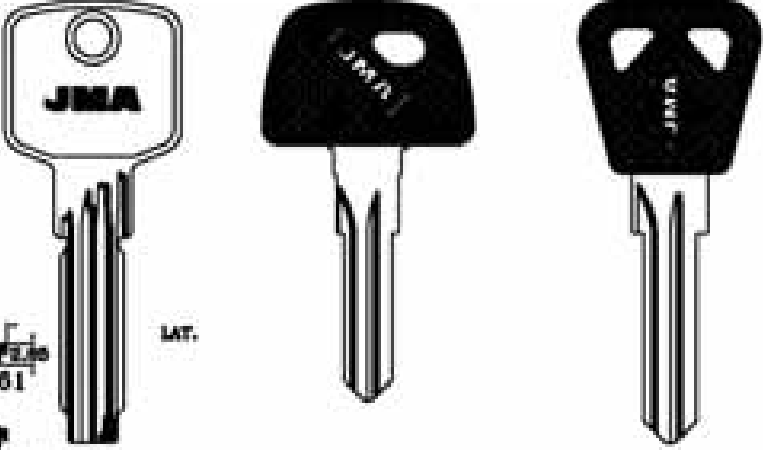

ABU-61 **ABU-63** **ABU-68** **ABU-64.P** **ABU-65.P** **ABU-72.P**

LAT.

ADAMSRITE

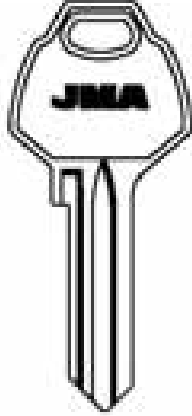



ADS-1D

PARA-FOR: **AEP**

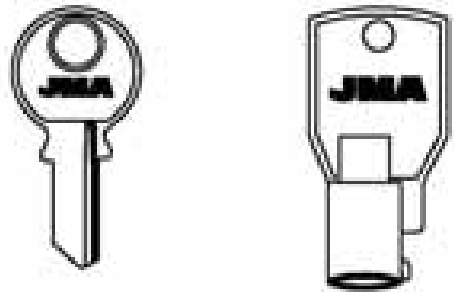

AEP-1D **AEP-2D**

AGA





AGA-1I **AGA-1T**

LAT.

Copyright by
Alpacra Alfas S.A.
1978

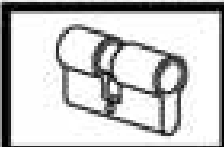
JMA



6

PARA:
FOR:

AGA

PARA-FOR:

AGA (E)

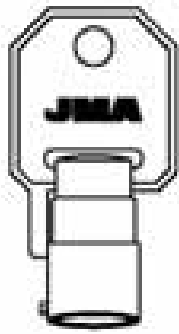

LAT.

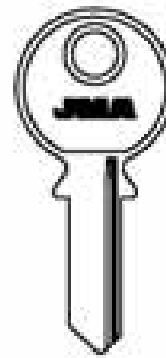

AGA-2T



AGA-3I



AGA-4I

AGA-4D

FAC-REMEX-KUPER-BOWED

PARA:
FOR:

AGA

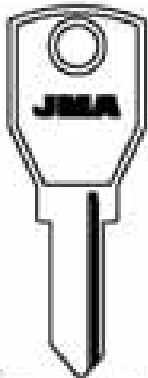

ALLI.

LAT.

LAT.

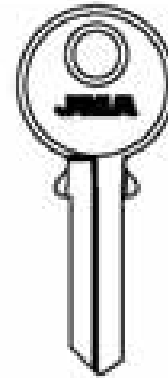
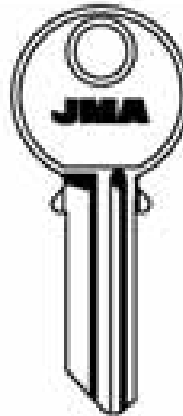

B
901-028
AGA-5I

A
901-028
AGA-5D

B
901-028
AGA-18I

A
901-028
AGA-18D

D
901-028
AGA-6I

C
901-028
AGA-8D

D
901-028
AGA-19I

C
901-028
AGA-19D

AGA-7

AGA-8D

MICALUX-SUYOKA

JOVI

GOYAL-REMEX

PARA:
FOR:

AGA

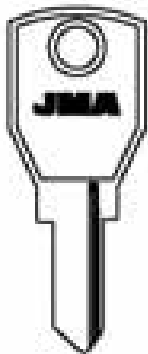

AGA-9I



AGA-23

ARRECIU-ALFA-CARI
ORRICO-BUTALCIO-SERRALLER

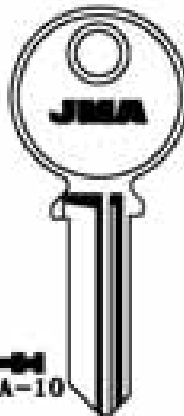

AGA-10

AGA-13I

AGA-22

CARI

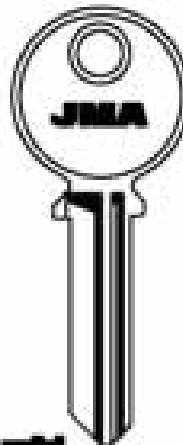

AGA-11

AGA-14D

CARI

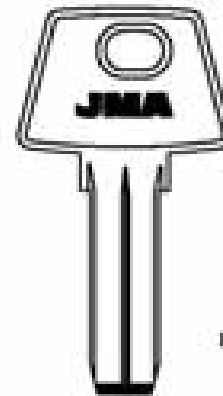

LAT.



AGA-12

COLONENCA-FB
SERRALLER-TENCA

Copyright by
Alejandro Altuna S.A.
2018

JMA

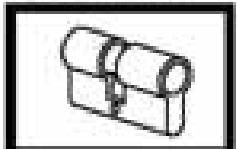

7

PARA-FOR:

AGA (E)

AGB (I)

PARA-FOR:

AGA

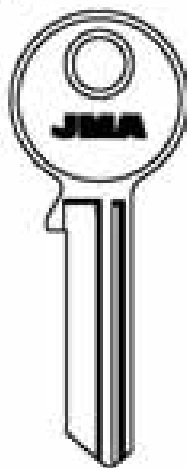

AGA-15

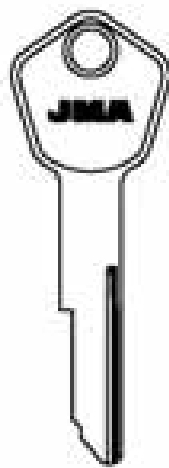

AGA-181

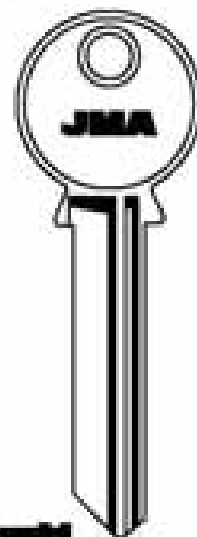

AGA-20

SERIALIZ

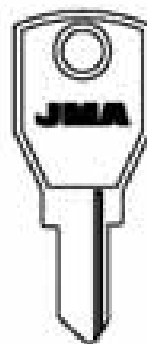

AGA-241

AGA-24D

PARA-FOR:

AGA

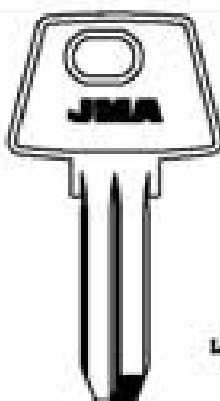

AGA-25

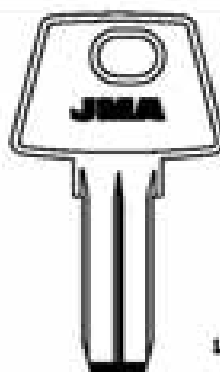

AGA-29

CASAS

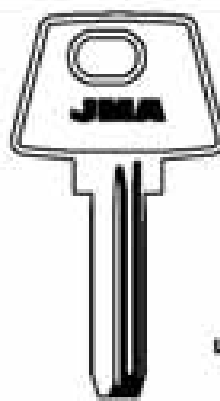

AGA-38

AGA-42

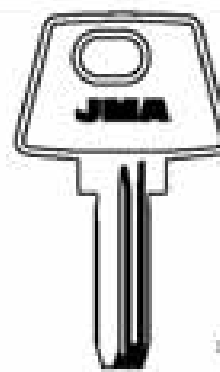

AGA-39

AGA-43

PARA-FOR:

AGA

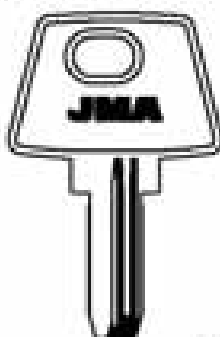

AGA-44



AGB-1

AGB-1D

GRAB

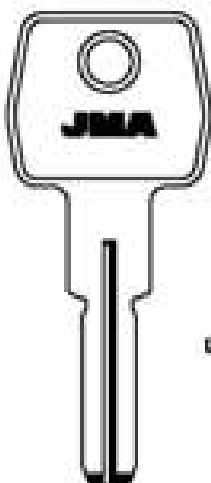

AGB-2

SCUDO

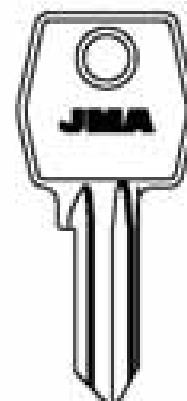

AGB-3

AGB-3D

GRAB







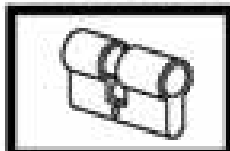



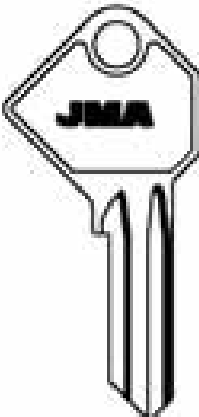
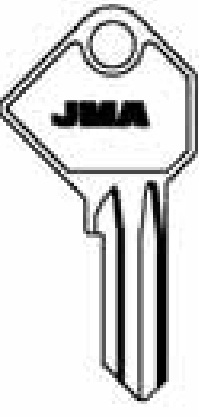
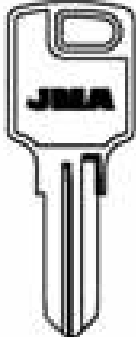
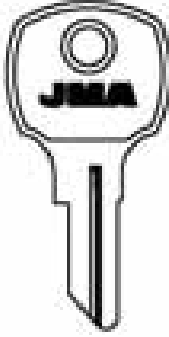
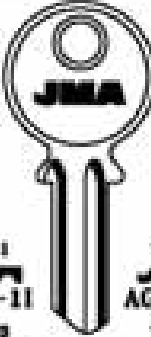

Copyright by
Alquadró Altierra S.A.

2019

JMA

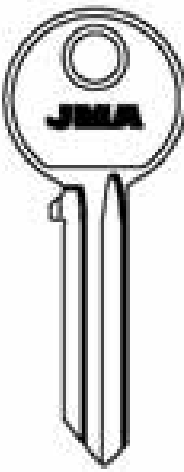
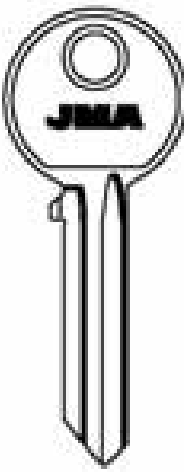
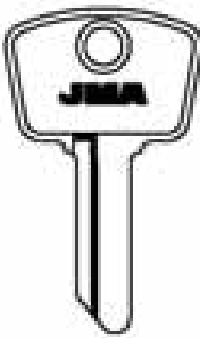

8

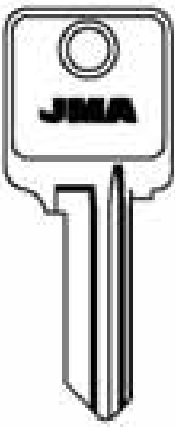
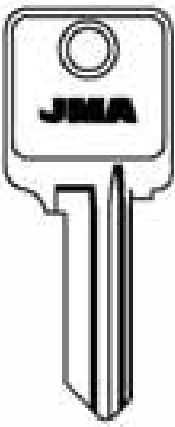
PARA: FOR:		AGB	AGC	PARA-FOR:	
		  <p>LAT. LAT.</p>   <p>AGB-4 AGB-5</p> <p>SCUDO 6000 SCUDO 6000</p>	  <p>AGD-1 AGD-2</p>		AGB (I) AGC (P) AGE (J) AGUIA (P) AGUT (E) AHRAM (ET) AIZPUTE (RUS)
PARA: FOR:		AGE	AGUIA		
		  <p>AGE-11 AGE-2D</p>	    <p>701 AG-11 701 AG-1D 706 AG-6I 706 AG-8D</p> <p>702 AG-3I 702 AG-3D 706 AG-6I 706 AG-8D</p> <p>704 AG-4I 704 AG-4D 709 AG-9I 709 AG-9D</p> <p>705 AG-5I 705 AG-5D 710 AG-10I 710 AG-10D</p>		
PARA: FOR:	AGUIA	AGUT	AHRAM	AIZPUTE	
	  <p>AG-11 AG-11D</p>	  <p>AGU-1D</p>	  <p>LAT.</p> <p>AHR-2 AHR-3</p>	  <p>AIZ-1 AIZ-2D</p>	

Copyright by
 Alejandro Altamir S.A.
 2010

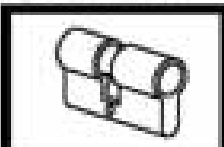
9

PARA-FOR:









**ALDRIDGE
(GB)**



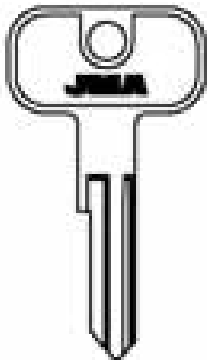







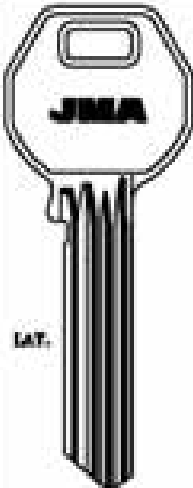



























ALE (E)







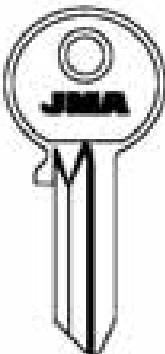
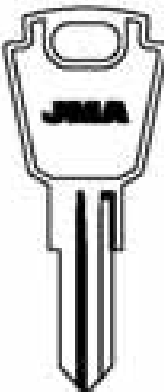
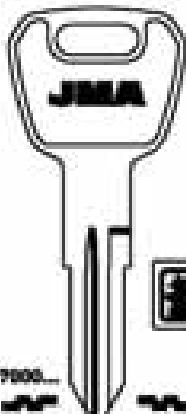
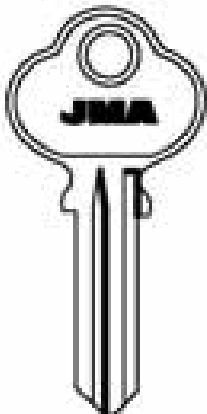

ALFA (S)

ALIANCA (BR)

ALPHA (J)

PARA-FOR:	ALDRIDGE			ALE	
					
	 AL-11	 AL-2 <small>ANEC</small>	 AL-3 <small>ANEC</small>	 ALE-1	 ALE-1D

PARA-FOR:	ALFA				
	 ALF-8	 ALF-15	 ALF-22D	 ALF-29	 ALF-36
	 ALF-7	 ALF-14D	 ALF-21	 ALF-28	 ALF-35
	 ALF-6	 ALF-13D	 ALF-20	 ALF-27	 ALF-34
	 ALF-5	 ALF-12D	 ALF-19	 ALF-26	 ALF-33
	 ALF-4	 ALF-11D	 ALF-18	 ALF-25	 ALF-32D
	 ALF-3	 ALF-10	 ALF-10D	 ALF-17	 ALF-24
	 ALF-1	 ALF-2	 ALF-9	 ALF-16	 ALF-23
			 ALF-16	 ALF-23	 ALF-30
			<small>DE DE</small>		

PARA-FOR:	ALIANCA	ALPHA		
				
	 ALC-1D	 ALP-11	 ALP-1D	 ALP-3
		<small>U...501-600</small>	<small>U...501-600</small>	
		 ALP-11	 ALP-1D	
		 ALP-6	 ALP-6D	
		<small>7000... ALP-2 ALP-2D JD-LINEX-MONACOR SANTY-VISORIC</small>		
		<small>U...501-600</small>		
		<small>FEI</small>		

Copyright by
Alejandro Allina S.A.

2018

JMA

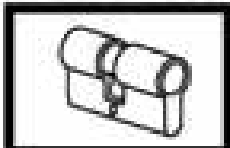

10

PARA:
FOR:

ALPHA

ALTAY

AMARU

PARA-FOR:

ALPHA (J)

ALTAY (RUS)

AMARU (P)

AMIG (E)

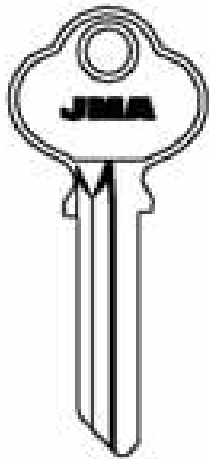

ALP-4D

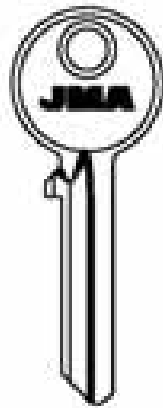

ALP-5D

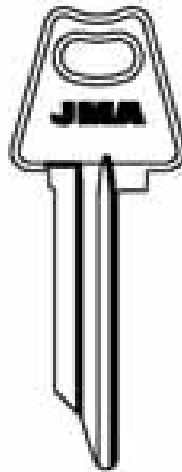

ATA-1

ATA-1D

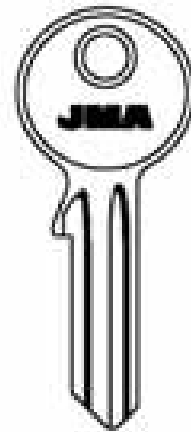

AMA-1

AMA-1D

AL

PARA:
FOR:

AMIG



1-15 / 1-80

AMG-1



1-88

AMG-2D

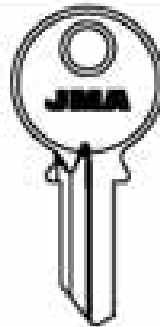

1-90

AMG-3D

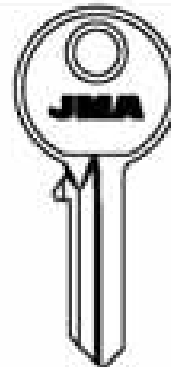

1-40

AMG-4D

PARA:
FOR:

AMIG



1-50

AMG-5D

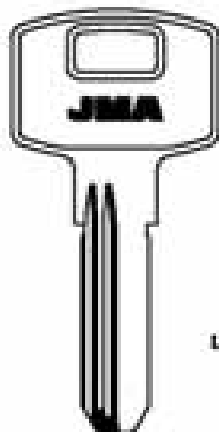

LAT.

AMG-8D
5500

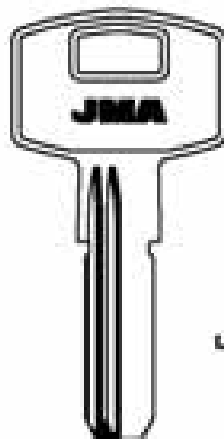

LAT.

AMG-9D
2500

CMB

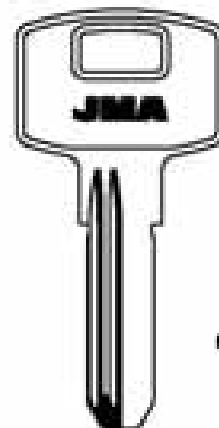

LAT.





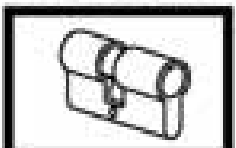

AMG-10

AMG-10D
4900

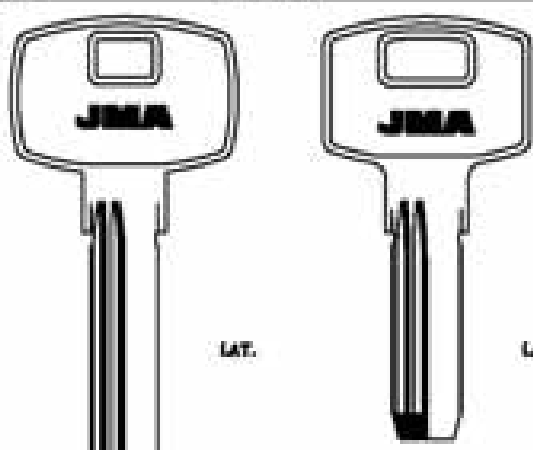
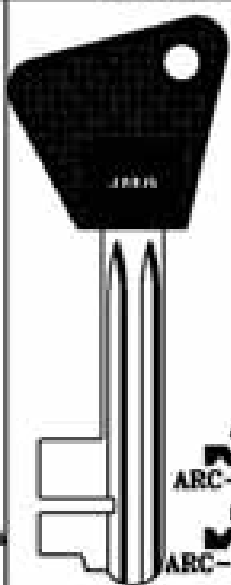
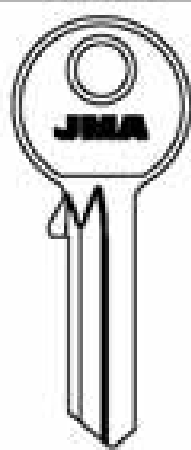
Copyright by
Alejandro Allmar S.A.
2018

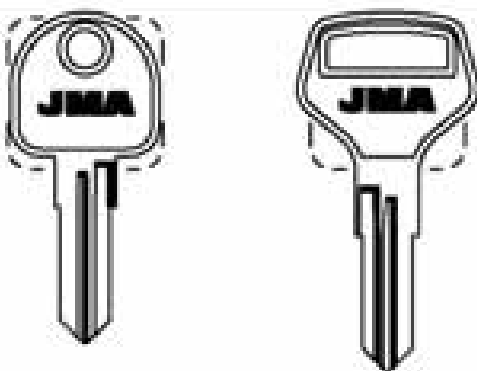
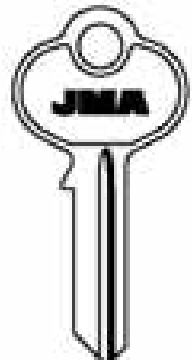

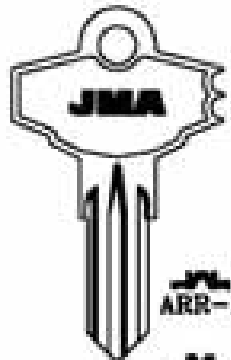

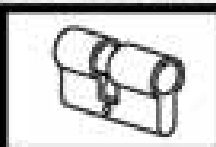

JMA



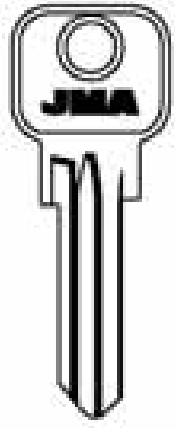
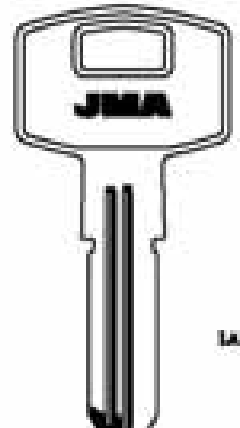

PARA: FOR:	APEX	ARCU	AREL	PARA-FOR:	
	 <p>LAT. LAT.</p> <p>AP-4D AP-5D</p> <p>FTM</p>	 <p>ALP.</p> <p>ARC-17.P ARC-17D.P</p>	 <p>ARE-1D</p>	<p>APEX (RUS)</p> <p>ARCU (E)</p> <p>AREL (GB)</p> <p>ARFE (E)</p> <p>ARMSTRONG (USA)</p> <p>AROUCA (BR)</p> <p>ARREGUI (E)</p> <p>ARROW (USA)</p>	
PARA: FOR:	ARFE		ARMSTRONG		
	 <p>ARFE-11 ARFE-1D</p> <p>ARFE-3D</p>		 <p>ARN-1 ARN-2D</p>		
PARA: FOR:	AROUCA	ARREGUI		ARROW	
	 <p>ARO-1D</p>	 <p>AR-1D AR-4IP AR-4DP</p> <p>INDAGX</p>		 <p>ARR-1 ARR-2 ARR-3 ARR-8</p> <p>DOMINION LOCK-PORT-LC</p>	<p>Copyright by Alejandro Altman S.A. 2010</p>   <p>13</p>

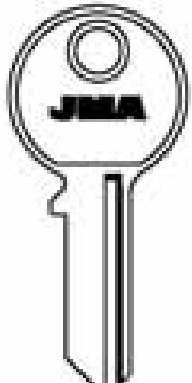
PARA-FOR:

- ARROW (USA)**
- ARSENEVSK (RUS)**
- ASHICO (TJ)**
- ASIA (RC)**
- ASPA (NL)**
- ASSA (S)**

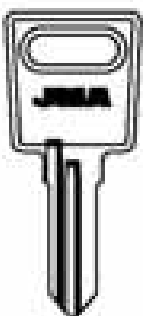
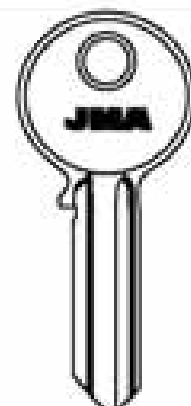
PARA-FOR:	ARROW	ARSENEVSK	ASHICO	ASIA
	 <p>LAT.</p> 	 <p>ARS-1D</p>	 <p>LAT.</p> 	  <p>ASI-1</p> <p>CINA</p>

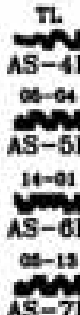
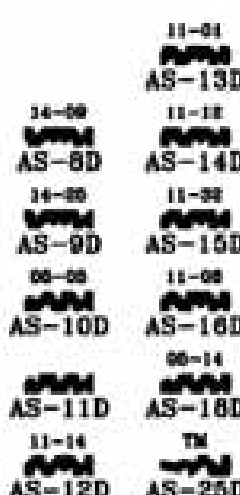
PARA-FOR:	ASSA		
ASPA			
 <p>ASP-1D</p>	 <p>ABC B AL B</p> 	 <p>TL</p> 	

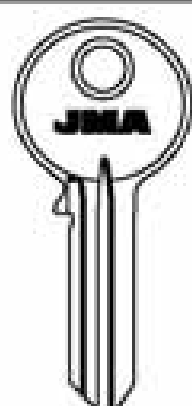
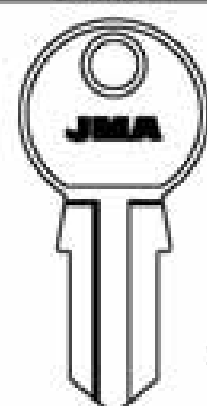
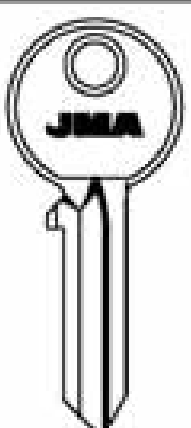
PARA-FOR:	ASSA		
	 <p>AS-20D</p>	 <p>LAT.</p> <p>AS-22</p>	 <p>TELA</p> <p>AS-23D</p>

Copyright by
Alejandro Allina S.A.
2018

JMA

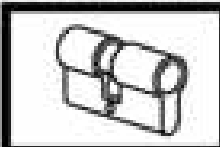

PARA:
FOR:

ASSA



28,4 mm.

- 580A AS-A5
- 580B AS-B5
- 580E AS-E5
- 580F AS-F5
- 580M AS-M5
- 580G AS-G5
- 580P AS-P5
- 580N AS-N5

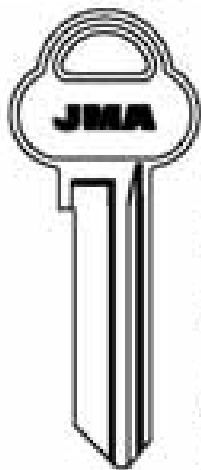

34,5 mm.

- 780A AS-A7
- 780E AS-E7
- 780L AS-L7
- 780M AS-M7
- 780P AS-P7
- 780S AS-S7
- 780B AS-B7
- 780F AS-F7
- 780K AS-K7
- 780G AS-G7
- 780N AS-N7
- 780R AS-R7
- 780EK AS-RK7
- 780RC AS-RC7
- 780RE AS-RE7
- 780RG AS-RG7
- 780RH AS-RH7
- 780RA AS-RA7
- 780RB AS-RB7
- 780RD AS-RD7
- 780RF AS-RF7
- 780RN AS-RN7

PARA-FOR:

ASSA (S)

PARA:
FOR:

ASSA

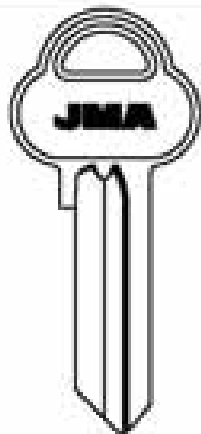

29,7 mm.

- 580AK AS-AK5
- 580AL AS-AL5
- 580AM AS-AM5
- 580BK AS-BK5
- 580EK AS-EK5
- 580EL AS-EL5
- 580EM AS-EM5
- 580FK AS-FK5
- 580DK AS-DK5
- 580DL AS-DL5
- 580DM AS-DM5
- 580MM AS-MM5
- 580CK AS-CK5
- 580GL AS-GL5
- 580GM AS-GM5
- 580NN AS-NN5
- 580V AS-V5
- 580U AS-U5
- 580T AS-T5
- 580W AS-W5

PARA:
FOR:

ASSA

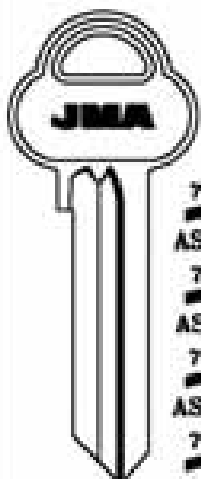

35,7 mm.

- 780AK AS-AK7
- 780AL AS-AL7
- 780AM AS-AM7
- 780BK AS-BK7
- 780BL AS-BL7
- 780EK AS-EK7
- 780EL AS-EL7
- 780EM AS-EM7
- 780FK AS-FK7
- 780FL AS-FL7
- 780DK AS-DK7
- 780DL AS-DL7
- 780DM AS-DM7
- 780GG AS-GG7
- 780KK AS-KK7
- 780FM AS-FM7
- 780GL AS-GL7
- 780GM AS-GM7
- 780MM AS-MM7
- 780NN AS-NN7
- 780RR AS-RR7
- 780EK AS-RK7
- 780RC AS-RC7
- 780RE AS-RE7
- 780RG AS-RG7
- 780RH AS-RH7
- 780RA AS-RA7
- 780RB AS-RB7
- 780RD AS-RD7
- 780RF AS-RF7
- 780RN AS-RN7
- 780D AS-D7
- 780U AS-U7
- 780V AS-V7
- 780Z AS-Z7
- 780H AS-H7
- 780W AS-W7
- 780T AS-T7
- 780X AS-X7

Copyright by
Allegre Almas S.A.
2018

JMA

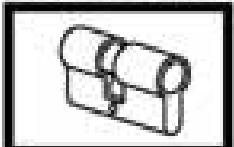































15

PARA-FOR:

PARA FOR:

ASSA

- ASSA (S)
- AUMON (E)
- AVANGARD (RUS)
- AZBE (E)

		 780LD AS-LD7	 780LG AS-LG7	 780MA AS-MA7	 780ME AS-ME7	 780PH AS-PH7	 780PN AS-PN7			
		 780KA AS-KA7	 780KE AS-KE7	 780MD AS-MD7	 780MG AS-MG7	 780PR AS-PR7	 780PT AS-PT7	 780KD AS-KD7	 780KG AS-KG7	 780MF AS-MF7
31 mm.	37 mm.	 780KF AS-KF7	 780LF AS-LF7	 780PF AS-PF7	 780PG AS-PG7	 780UU AS-UU7	 780WW AS-WW7			
 580KE AS-KE5	 580ME AS-ME5	 780LA AS-LA7	 780LE AS-LE7	 780PA AS-PA7	 780PB AS-PB7	 780XX AS-XX7				

PARA-FOR: AUMON

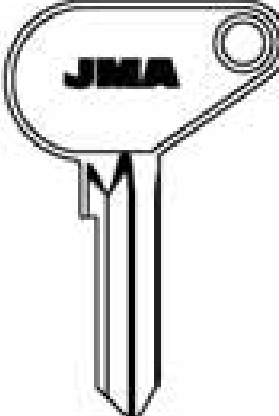

AUM-2D

AVANGARD



AV-1



AV-1D



AV-2D

AZBE

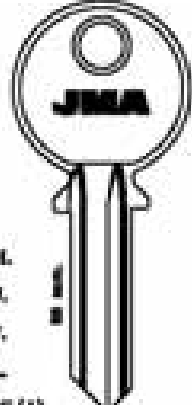

AZ-1I

PH.
 ALL.
 LAT.
 COL.

• WTC(A)



AZ-1D

EADH

PARA-FOR: AZBE

 <p>ALL. LAT. COL.</p>	 <p>ALL. LAT.</p>		 <p>ALL.</p>
 <p>AZ-2I</p>	 <p>AZ-2D</p>	 <p>AZ-3I</p>	 <p>AZ-3D</p>
 <p>AZ-4</p>	 <p>AZ-6</p>		

Copyright by
Alejandro Allina S.A.
2018

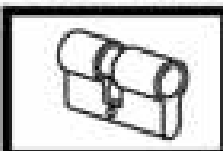

PARA:
FOR:

AZBE

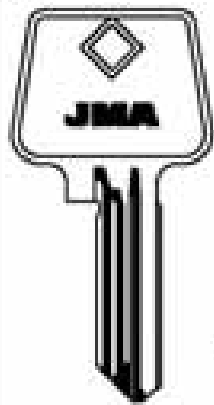

ALP.



AZ-7

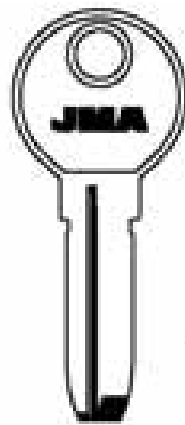

ALP.



AZ-8D

IFAM

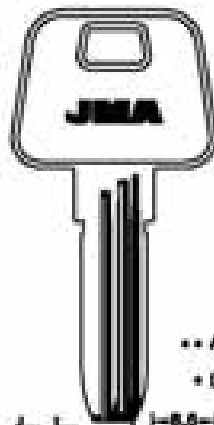

•• ALP.
• LAT.



AZ-9

AZ-9D••



•• AZ-12

• AZ-29

CAVERO-CENTURION-EAM

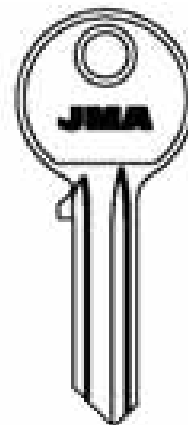

AZ-10

PARA-FOR:

AZBE (E)

AZKOYEN (E)

B+D (GB)

BAB (D)

PARA:
FOR:

AZBE

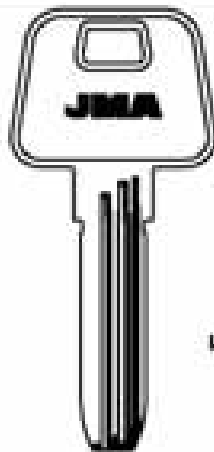

LAT.



AZ-14

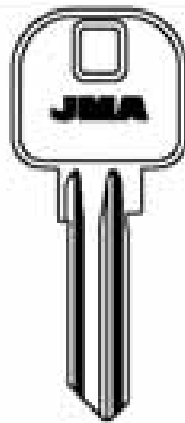

AZ-17



AZ-17D

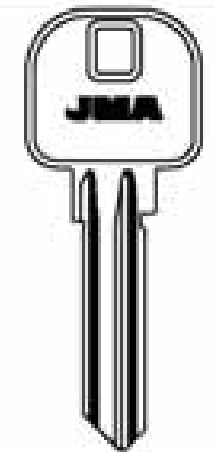

AZ-18



AZ-18D

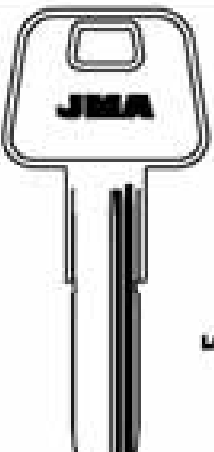

LAT.



AZ-32

PARA:
FOR:

AZBE

AZKOYEN

B+D

BAB

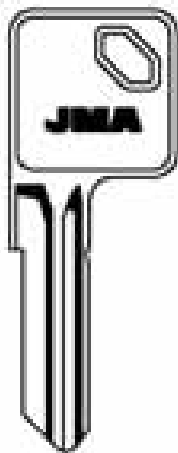

SCO-1

SCYLAGE-SCOVILL

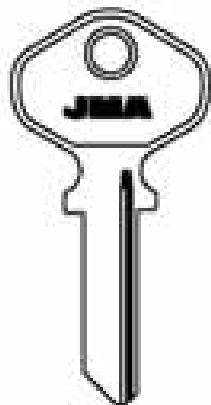

AZKO-11

ACA

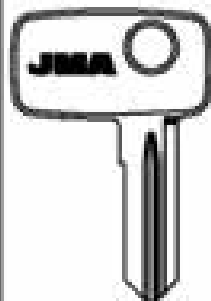

BD-1

ROLL & DOOR

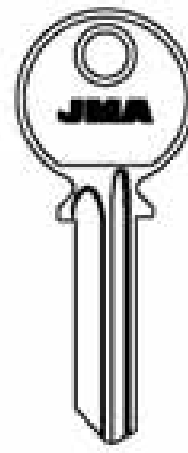

BAB-11

Copyright by
Allegre Almas S.A.
2010

JMA

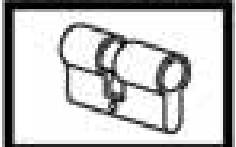

17

PARA-FOR:







BAB (D)



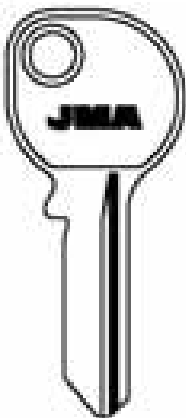
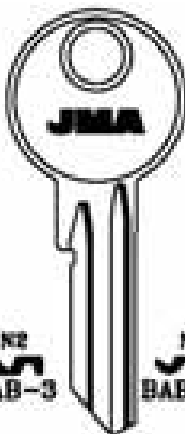
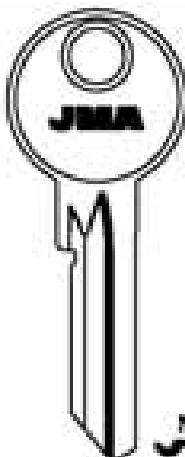

BAGEM (E)

BALTIKA (RUS)

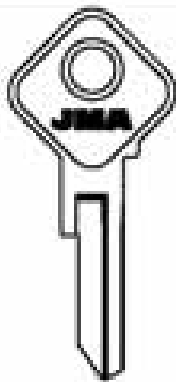
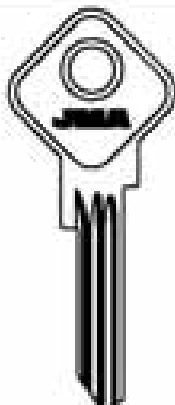

BANHAM (GB)



BAODEAN (TJ)

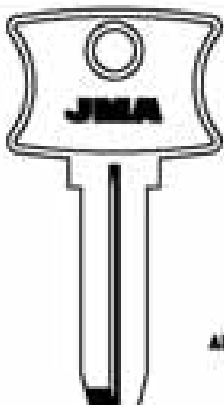
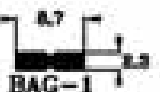

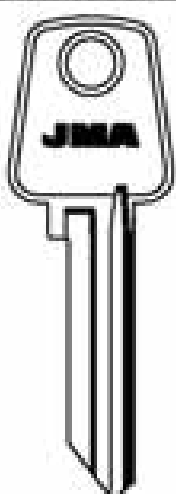
PARA-FOR:	BAB			
		 N2 BAB-3 N1 BAB-3D BAB-11	 SN2 BAB-5 SN1 BAB-5D	 BAB-6
	 BAB-21	 BAB-12D	 BAB-4D	 BAB-5D

PARA-FOR:	BAB		
			
	 BAB-7	 BAB-8D	 BAB-9D

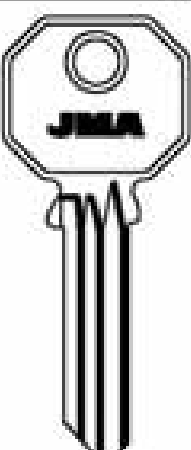
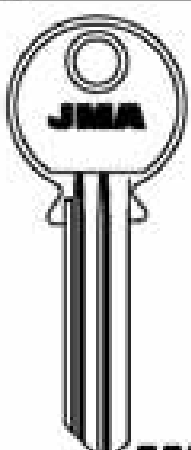
PARA-FOR:	BAGEM
	
	 BAG-1

PARA-FOR:	BALTIKA
	
	 BLT-1

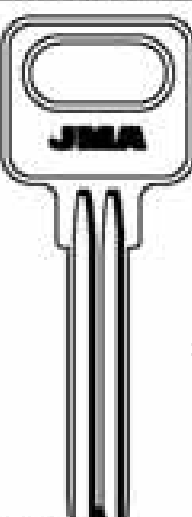
PARA-FOR:	BANHAM	
		
	 BAN-11	 BAN-1D





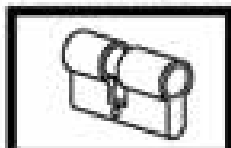

PARA-FOR:	BAODEAN
	
	 BDA-1



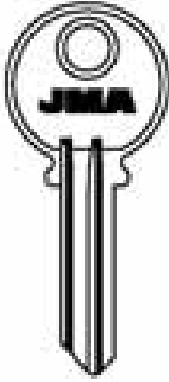



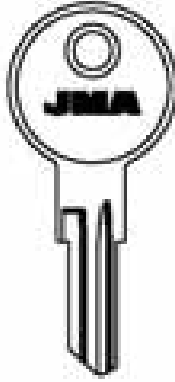

Copyright by
Algenestre Altriss S.A.
2008

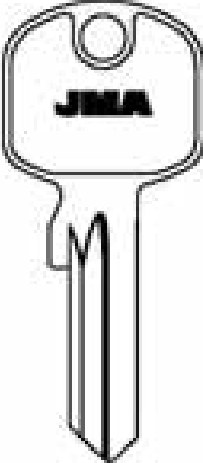

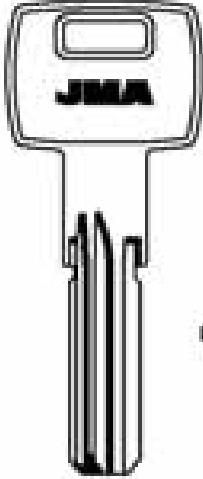

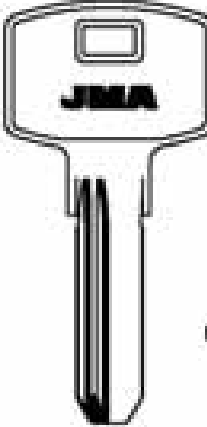

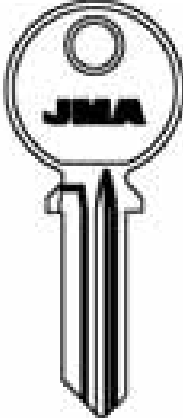

JMA

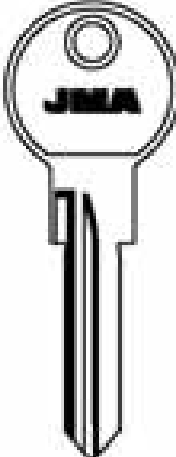

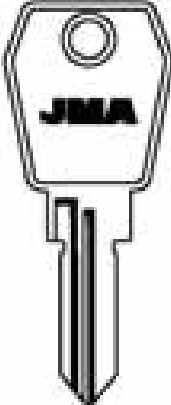
18

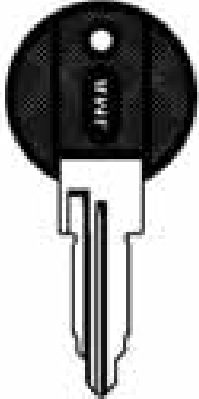
PARA: FOR:	BARCZ	BARIER	BASCO
 <p>  BCZ-1  BCZ-2 </p>	 <p>  BRR-1 </p>	 <p>  BAS-4 <small>AMERICAN M.-BAS-CHICAGO C. ELMO-BERKE E.-ILLINOIS-YALE</small> </p>	PARA-FOR: BARCZ (PL) BARIER (RUS) BASCO (USA) BASI (D) BASTA (IRL) BATU (E)

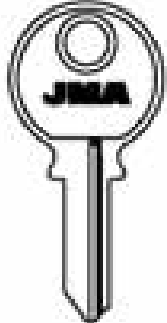
PARA: FOR:	BASI		BASTA
 <p>  BAI-1D </p>	 <p>  BAI-8D <small>SATURN</small> </p>	 <p>  BAI-9D <small>TOYOTA</small> </p>	 <p>  BAST-11 </p>

PARA: FOR:	BASTA		BATU
 <p>  BAST-2D </p>	 <p>  BAST-3D <small>EURO LOCKS</small> </p>	 <p>  BAST-4D.P </p>	 <p>  BATU-11 </p>

Copyright by
 Alejandro Altamir S.A.
 2010
JMA

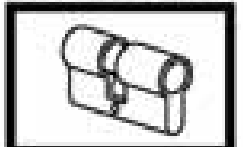

PARA:
FOR: **BILMA**

BKS

PARA-FOR:

BILMA (E)

BKS (D)

BODA (SF)



LAT.



BIL-1T

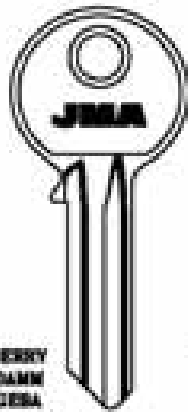

BERRY
DANN
GESA
HOERHMANN
PE
YALE



BK-11



BK-1D

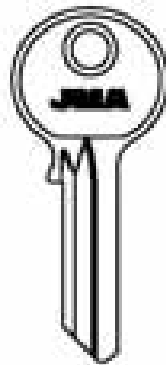

ALL.



BK-2D

YALE

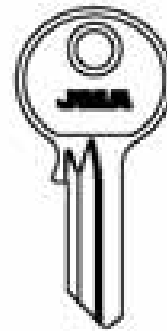

BK-3D

YALE-PECO

PARA:
FOR: **BKS**

BKS



BK-4



BK-4D



BK-5I



BK-5D

METRO-YALE

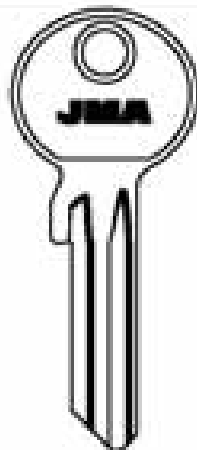

BK-6I



BK-6D

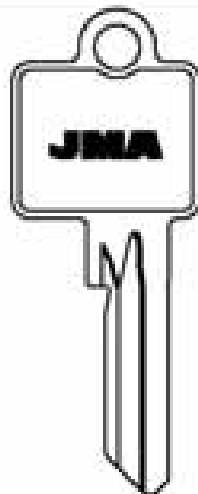

BK-7D

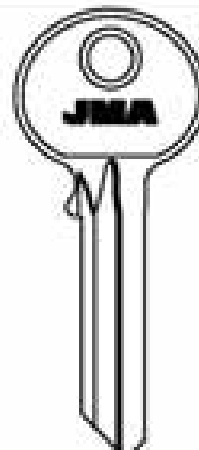

BK-8D

PARA:
FOR: **BKS**

BKS

BODA

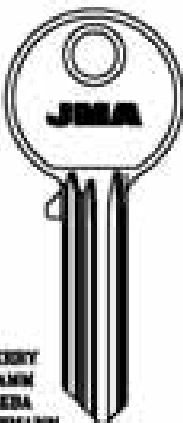

BERRY
DANN
GESA
HOERHMANN
PE
YALE



BK-9
SERIE 0

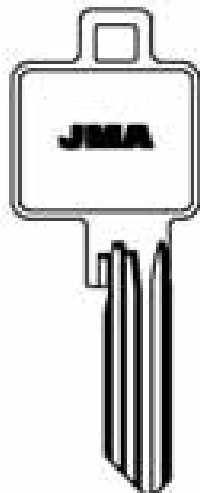

BK-14

PE-YALE

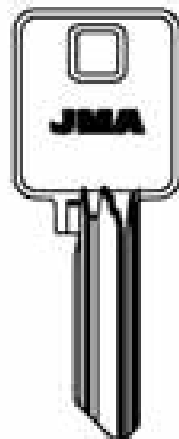

SERIE 2000
BK-16/30

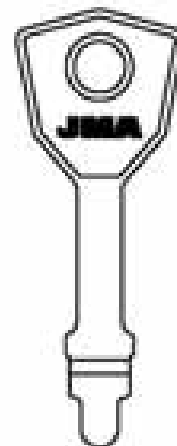

BOD-1

Copyright by
Allegre Almas S.A.
2010



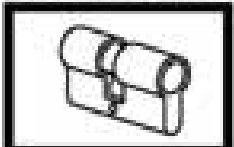

JMA





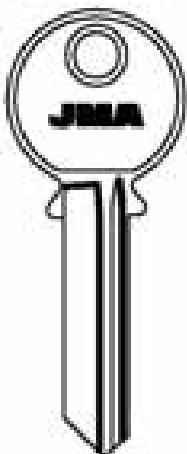
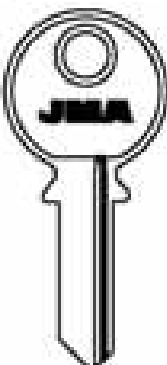
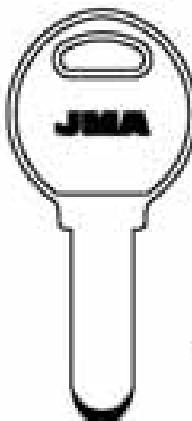
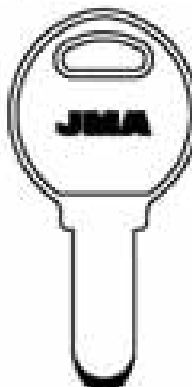







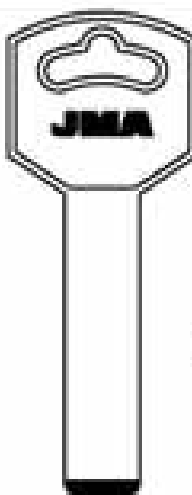







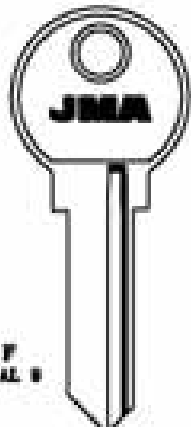
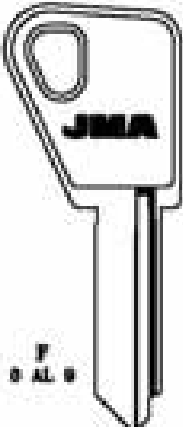
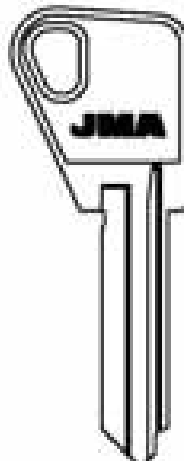











21

PARA-FOR:

- BOMORO (D)**
- BÖRKEY (D)**
- BOULTON & PAUL (GB)**
- BRABANTIA (E)**
- BRAS (E)**
- BRASIL (BR)**
- BRICARD (F)**

PARA-FOR:	BOMORO		BÖRKEY	
				
				
	LAPORTE-FRESTA		PHILLIPS-YALTIRES	

PARA-FOR:	BOULTON	BRABANTIA	BRAS	BRASIL
				
				
	RST	BRA-2	BRAS-1	BRS-1

PARA-FOR:	BRICARD							
								
								
								
	STYEMER							

Copyright by
Magnum Altran S.A.
2013



22

PARA:
FOR:

BRICARD

PARA-FOR:

BRICARD (F)

BRUMME (D)

BSS (YU)

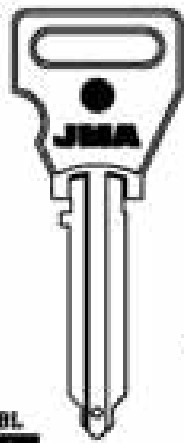

LAT.

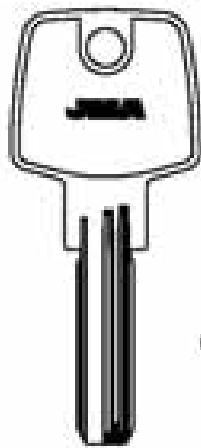

LAT.



BRI-18

BRI-18D

BRI-19

BRI-22

BRI-23

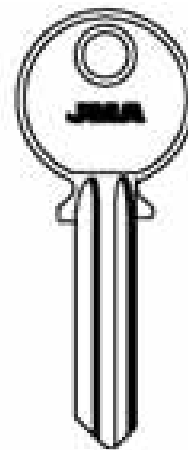

BRI-24

BL
BRI-10

BRI-12

BLOCKOUT-INLOC



BRI-16

ABUS

PARA:
FOR:

BRICARD

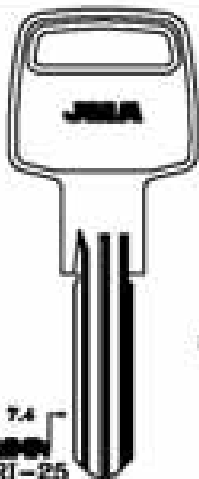

LAT.

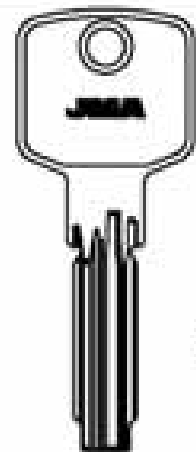

LAT.



BRI-26



BRI-28



BRI-29



BRI-31

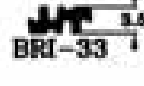

BRI-33

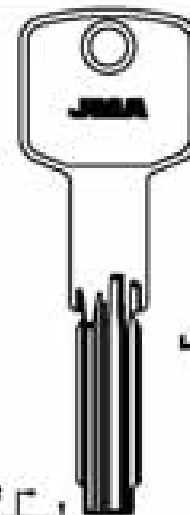

LAT.

7.4
BRI-25

BRI-27



BRI-30

PARA:
FOR: BRICARD

BRUMME

BSS



BRI-32D

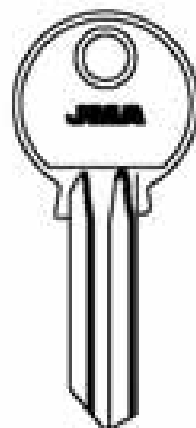

BRU-1 BRU-1D

PANA



BSS-1D

BANE SEKULIĆ

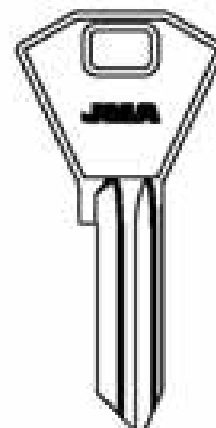

BSS-2 BSS-2D

BANE SEKULIĆ

Copyright by
Alejandro Altman S.A.
2010

JMA

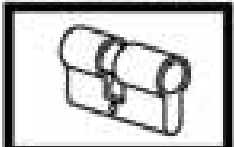

23







PARA-FOR:



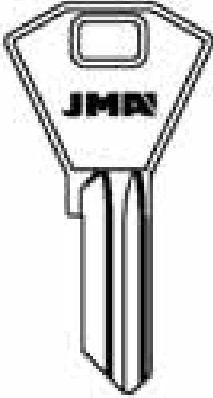

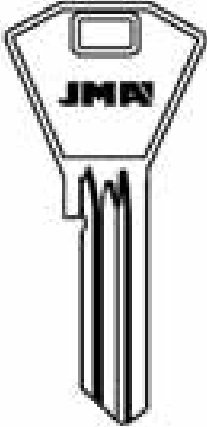
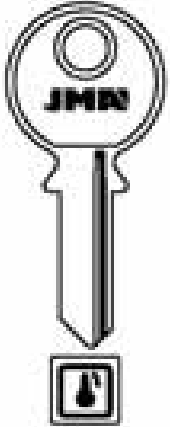

BSS (YU)



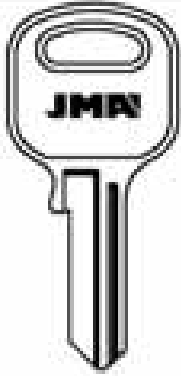
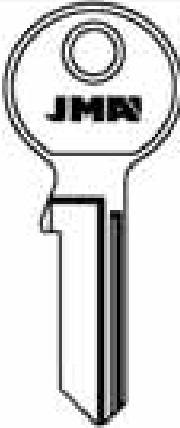



BTV (E)

BUGA (D)

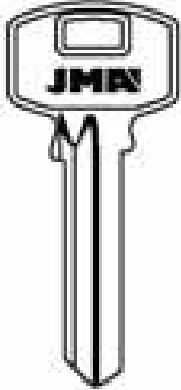
BULAT (RUS)

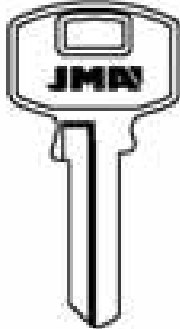
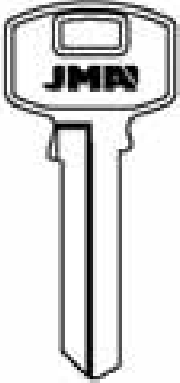
PARA-FOR:	BSS			BTV
				
				
	BSS-3	BSS-4D	BSS-5D	BTV-11 BTV-1D
	BAVE BEKULIĆ	BAVE BEKULIĆ	BAVE BEKULIĆ-GE GE	EADY

PARA-FOR:	BUGA		BULAT	
				
				
	BAI-6	BAI-7	BUL-1	BUL-2D BUL-6D
			LAT.	

PARA-FOR:	BULAT			
				
				
	BUL-3D	BUL-4D	BUL-5D	BUL-7D

Copyright by
Alejandro Allina S.A.
2018

JMA

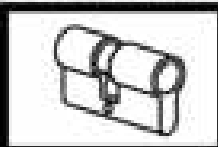

24

PARA:
FOR:

BURG

PARA-FOR:

BURG (D)

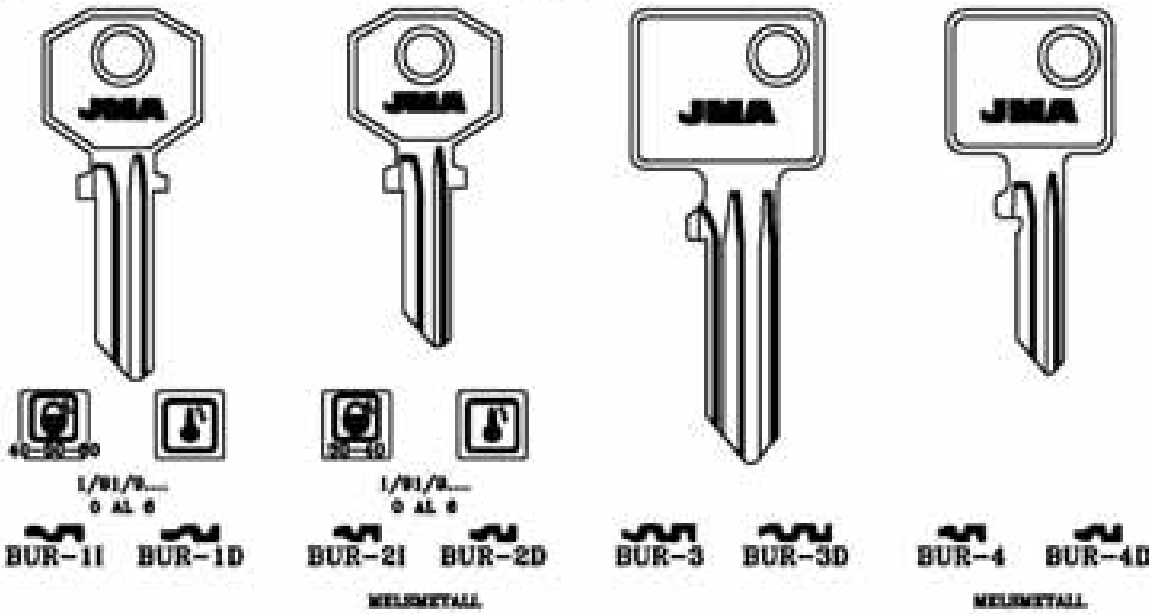

PARA:
FOR:

BURG



PARA:
FOR:

BURG

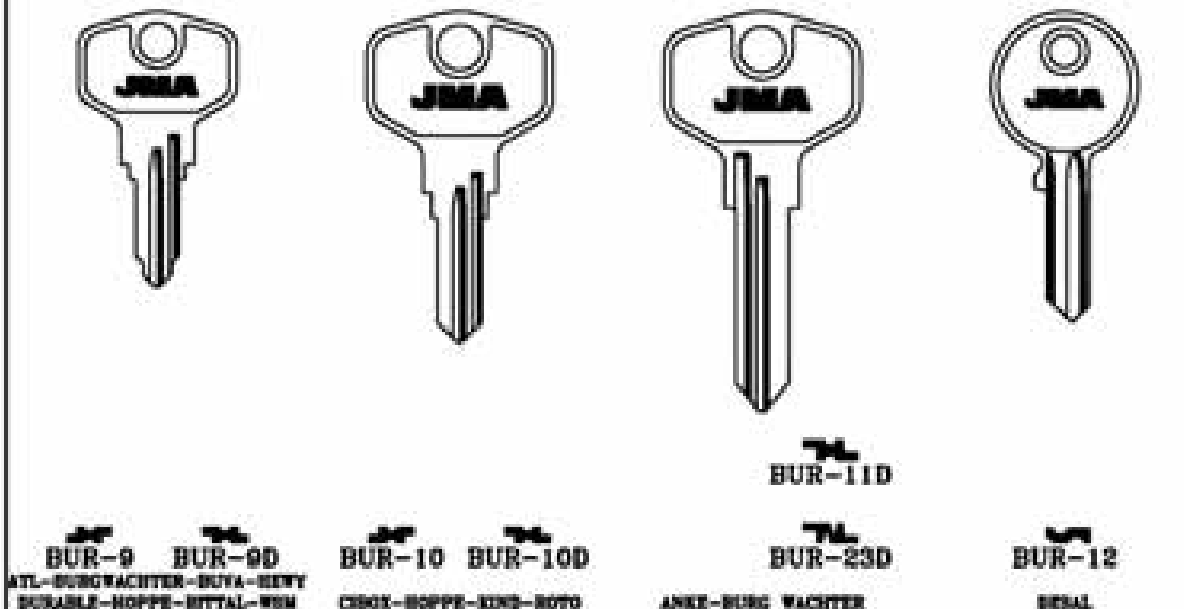

Copyright by
Algebra Almas S.A.
2018

JMA



25

PARA-FOR:

BURG (D)

BUS (D)

BUVA (D)

PARA-FOR:

BURG

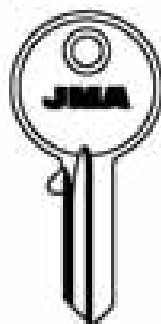

BUR-13D

ITEM - BITTAL



BUR-14 **BUR-14D**
SEE C40
BUR-19D



BUR-15

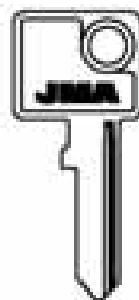

BUR-16

PARA-FOR:

BURG

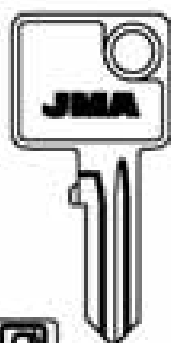

BUR-17 **BUR-17D**
SEE C30
BUR-20D

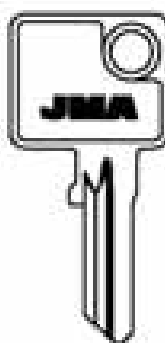

BUR-18D



BUR-21D



BUR-22D

PARA-FOR:

BURG

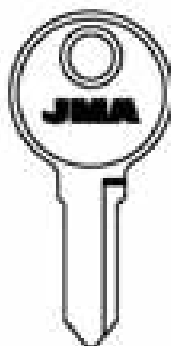

BUR-24 **BUR-24D**

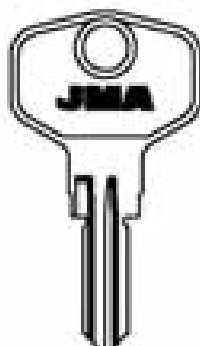

BUR-25D

BUS



BUS-1

ICCOPT

BUVA

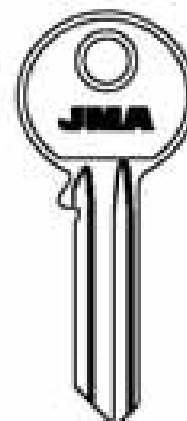

BU-11 **BU-1D**

Copyright by
Allegre Alfas S.A.
2018

JMA

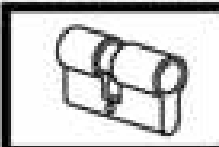

PARA:
FOR:

CARTERO



ACA-FAC-ETB



ASA

CAS CISMA



1001-2178
CIS-11 CIS-1D



CIS-2



CIS-3

PARA-FOR:

- CARTERO (E)
- CAS CISMA (D)
- CASAS (E)
- CASH BOX (D)
- CAVERS (F)

PARA:
FOR:

CAS CISMA

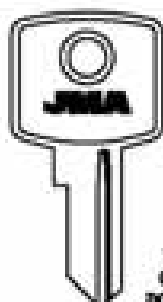

CIS-4



CIS-5

BY
CAR
DOMUS
GUARDIAN
MIT
SESO
STIQAM
TENTA



LIT.



EPE
CIS-8D

CASAS

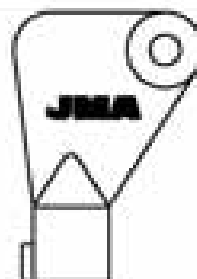

CASAS-1T

CASH BOX



CSB-1D



0-1-2

CSB-2D

ARRIGUI-FAC-JOMA

PARA:
FOR:

CAVERS



CA-11

CITY

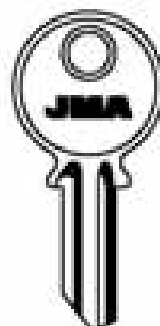

CA-21

CA-101

CITY-SENICA

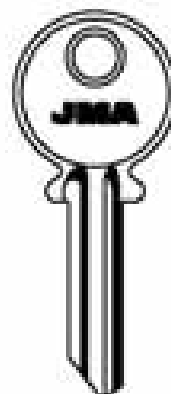

CA-31

CA-91

CITY-EVE



CITY
ATP
CAP
FO
PROTEC
QCP
SIAM
SOS
VIP
SENICA

CA-41

CA-121

CA-4D

Copyright by
Algebra Almas S.A.
2018

JMA

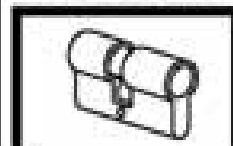

27

PARA-FOR:

CAVERS (F)

CAYS (E)

CEMA (I)

CENTURY (GB)

PARA-FOR: **CAVERS**

CA-5I CA-11I ZENITH-ZENICA

CA-8D CA-13D ZENITH-ZENICA

CA-7 CA-7D FO-ZENITH

ARNOU FO MONOBLOC ZENITH CA-8I CA-8D

PARA-FOR: **CAVERS**

CA-14D ZENI

CA-15I CITY

PARA-FOR: **CAYS**

+ ASA, LAT.
+ MTC.(T)
+ PSL.

CAY-1I CAY-1D ILARCI-588

CAY-2 158D

PARA-FOR: **CEMA**

CMA-1 CMA-2 ELFIN-LANPA

CMA-1D CMA-2D

PARA-FOR: **CENTURY**

CENT-1I CENT-1D ALLGOOD

CENT-2I CENT-2D ALLGOOD

CENT-3D WR 1 AL 4

Copyright by
Alpastra Allioni S.A.
2010

JMA



PARA-FOR: CENTURY

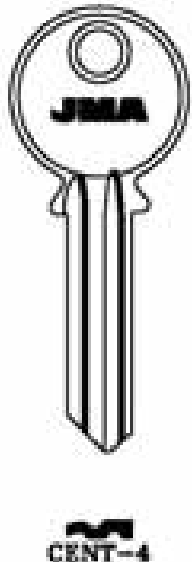

CENT-4

CERRAMARC



CER-1

CES

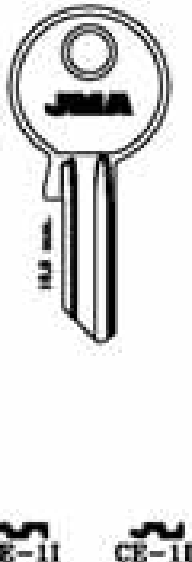

CE-11 CE-10
STUY

PARA-FOR:
CENTURY (GB)
CERRAMARC (E)
CES (D)

PARA-FOR: CES



CE-21 CE-22

40
401-410
10C
1-10
HLV
811-900
BODA
ELETT
FRECOV
KNAPP

**ELETT
FRECOV
NAPELE
RANNO
JOSTA
KARDEX
KIND
KNAPP
MAUSER
NEMEF
OLNAR
SANTIS
VORO
WAND
WECO**

CE-110

CE-108



CE-101D

CE-100D

CE-99D

CE-31 CE-3D

BODA
ELETT
FRECOV
KNAPP

**ELETT
FRECOV
NAPELE
RANNO
JOSTA
KARDEX
KIND
KNAPP
MAUSER
NEMEF
OLNAR
VORO
WAND
WECO**

PARA-FOR: CES

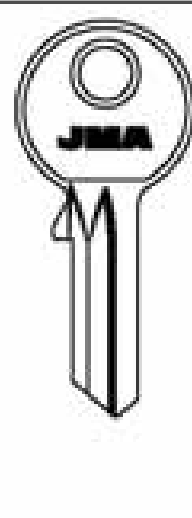

CAIMA-SPECIAL

CE-4D



CE-5 CE-5D

ALLI

**BERRY
CONNA
FIFI
HORNMARK
MBS
NEMEF
SANTIS
SOLID
STUY
TERTON**

CE-92 CE-92D

CE-93D

Copyright by
Alejandro Allier S.A.
2010





29

PARA-FOR:

CES (D)

PARA FOR:

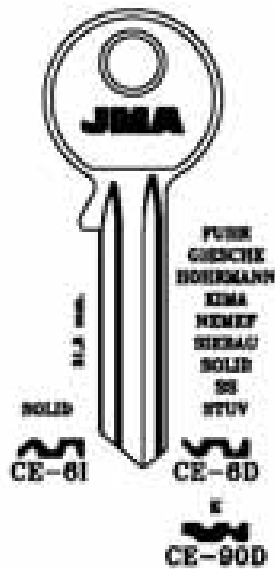
CES



- | | |
|-------|-------|
| 444 | 444 |
| CE-54 | CE-67 |
| 444 | 444 |
| CE-58 | CE-68 |
| 444 | 444 |
| CE-59 | CE-69 |
| 444 | 444 |
| CE-60 | CE-70 |
| 444 | 444 |
| CE-61 | CE-71 |
| 444 | 444 |
| CE-62 | CE-72 |
| 444 | 444 |
| CE-63 | CE-73 |
| 444 | 444 |
| CE-64 | CE-74 |
| 444 | 444 |
| CE-65 | CE-75 |
| 444 | 444 |
| CE-66 | CE-76 |

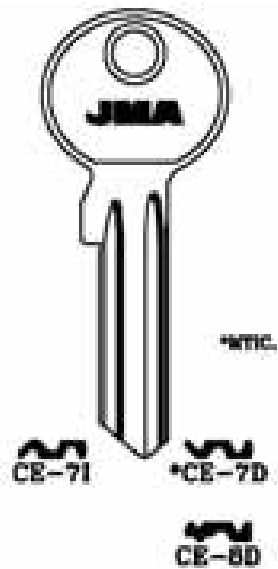

SOLID

LAT.

WTC

PARA FOR:

CES



- | | | | | | |
|--------|--------|--------|--------|--------|---------|
| X20 | X20 | X27 | W24 | W21 | |
| CE-80 | CE-160 | CE-230 | CE-300 | CE-370 | |
| X24 | X21 | X28 | W25 | W22 | W28 |
| CE-100 | CE-170 | CE-240 | CE-310 | CE-380 | CE-440 |
| X25 | X22 | X29 | W26 | W23 | W29 |
| CE-110 | CE-180 | CE-250 | CE-320 | CE-390 | CE-450 |
| X26 | X23 | X40 | W27 | W24 | W40 |
| CE-120 | CE-190 | CE-260 | CE-330 | CE-400 | CE-460 |
| X27 | X24 | X41 | W28 | W25 | W41 |
| CE-130 | CE-200 | CE-270 | CE-340 | CE-410 | CE-470 |
| X28 | X25 | X42 | W29 | W26 | W42 |
| CE-140 | CE-210 | CE-280 | CE-350 | CE-420 | CE-480 |
| X29 | X26 | W23 | W30 | W27 | |
| CE-150 | CE-220 | CE-290 | CE-360 | CE-430 | CE-1180 |

SOLID

PARA FOR:

CES

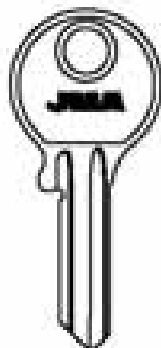

- | |
|-------|
| 35 |
| CE-51 |
| 36 |
| CE-52 |
| 37 |
| CE-53 |
| 38 |
| CE-54 |
| 40 |
| CE-55 |
| 45 |
| CE-56 |
| 46 |
| CE-57 |
| 47 |
| CE-58 |
| 48 |
| CE-59 |
| 49 |
| CE-60 |
| CE-52 |

- | | |
|-------|--------|
| CE-49 | CE-49D |
|-------|--------|

- | | |
|-------|--------|
| CE-51 | CE-51D |
|-------|--------|

- | | |
|-------|-------|
| CE-80 | CE-88 |
|-------|-------|

SOLID

LAT.

Copyright by
Algodora Alfama S.A.
2018

JMA

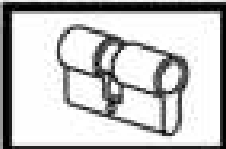

30

PARA:
FOR:

CES

PARA-FOR:

CES (D)

CHAVO (P)

CHELIABINSK
(RUS)

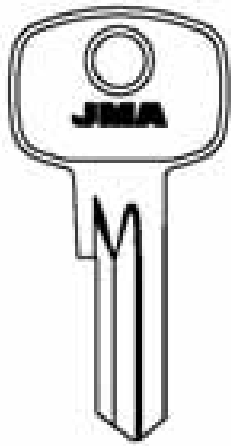

CE-53D

RUSSIA



CE-89



CE-89D



CE-94

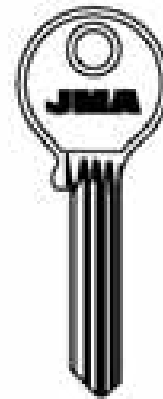

CE-96

CE-97

LAT.

PARA:
FOR:

CES

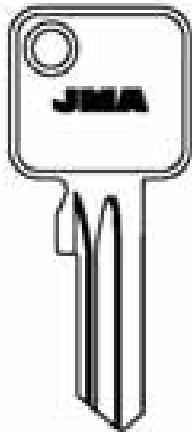

CE-98D

CASMA-SPECIAL

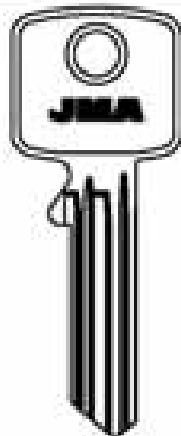

CE-105

CE-103

CE-102

CE-117D

CE-111D

CE-104D



CE-107

CE-106

RUSSIA

PARA:
FOR:

CES

CHAVO

CHELIABINSK



CE-109D

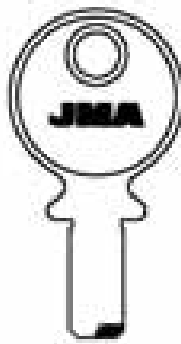

CE-114

LAT.



CHA-2

CHA-2D

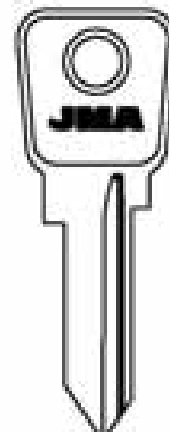

CHTZ-1

Copyright by
Alejandro Altamir S.A.
2010

JMA

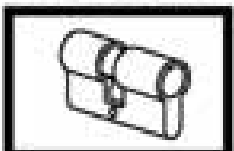

31

PARA-FOR:

CHEYLOCK (HK)

CHICAGO (USA)

CHUBB (GB)

CIEF (F)

CIELS (F)

CIFIAL (P)

PARA-FOR: CHEYLOCK

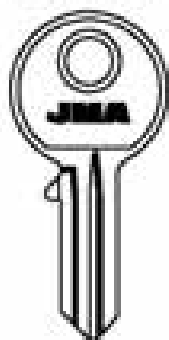

CHEK-1

CHICAGO



CHI-1

CHI-3

CHI-5



CHI-2

CHI-4

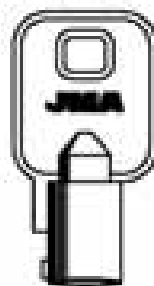

CHI-1T

**ACE-ADRENCO-JGA-ALPHA
EURO LOCKS-FORT-DEM-L & P**

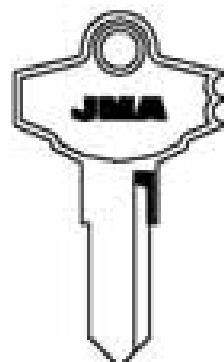

CHI-6

ILLINOIS OGA

LAT.

PARA-FOR: CHICAGO



**FR
CHI-7D**

**FR
CHI-8D**

**XF
CHI-9D**

**XF
CHI-10D**

STEELCASE

CHUBB

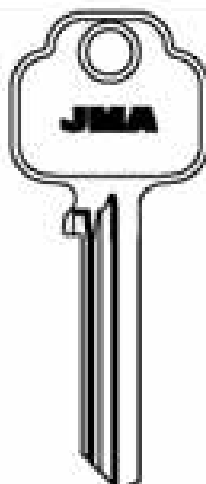

CHU-1D

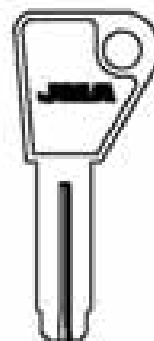

CHU-10

AVA-CHUBB

LAT.

CIEF

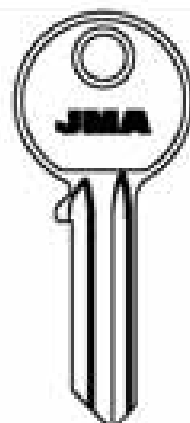

CF-11

CF-1D

EMATE-FEF

PARA-FOR: CIELS

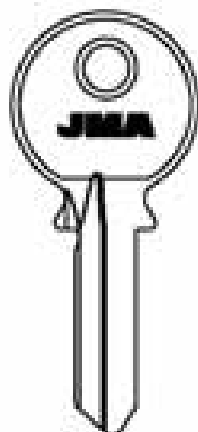

CIE-1D

CIFIAL



CIF-1D

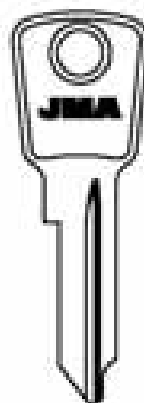

CIF-2D

LEPENSURE

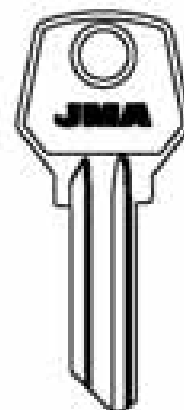

CIF-3

CIF-3D

EPER

Copyright by
Allegretto Allmax S.A.
2018

JMA

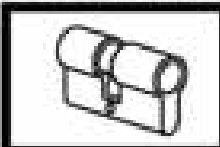

32

PARA-FOR:

FOR:

CISA

CISA (I)

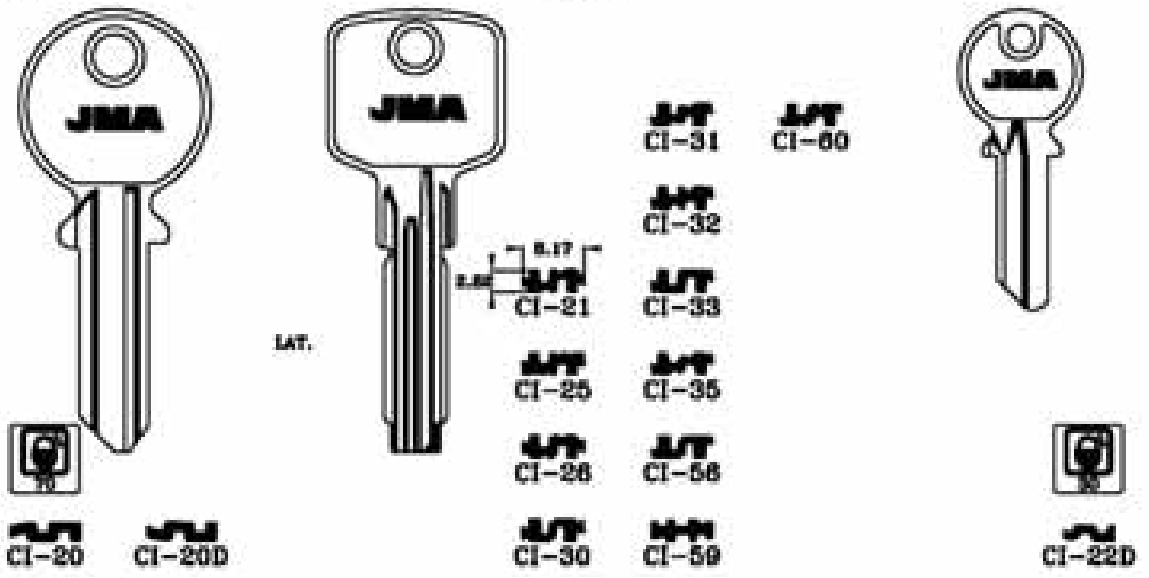

ABUS - ALTRAL - AXIS

PARA-FOR:

CISA



PARA-FOR:

CISA

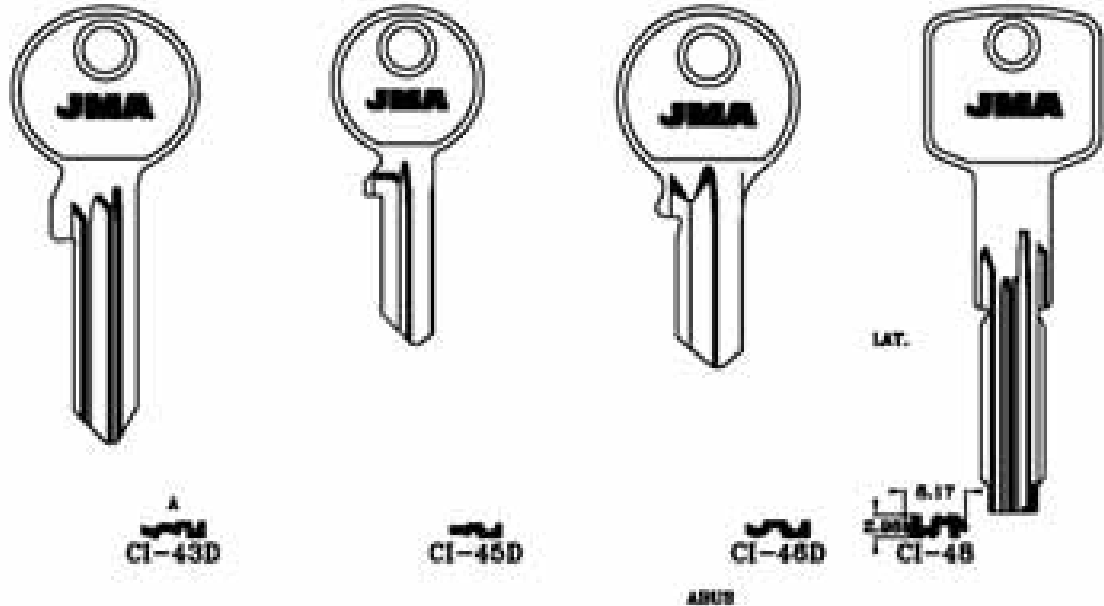

ABUS

Copyright by
Alpacra Alfas S.A.
2018

JMA



PARA:
FOR:

CISA

PARA-FOR:

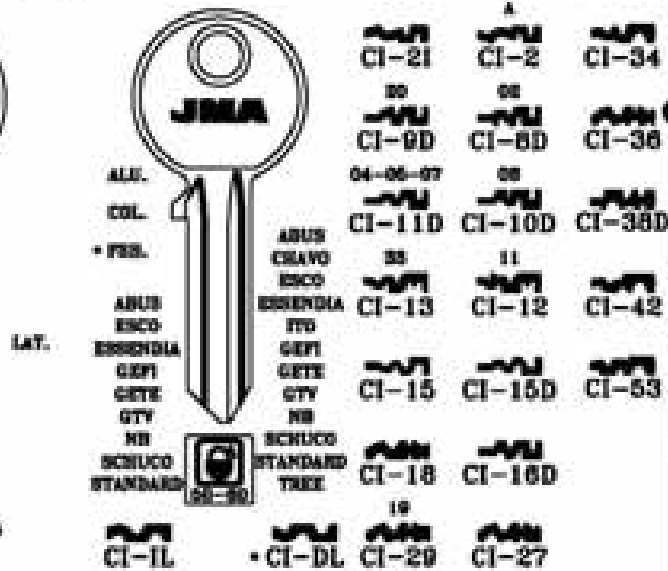
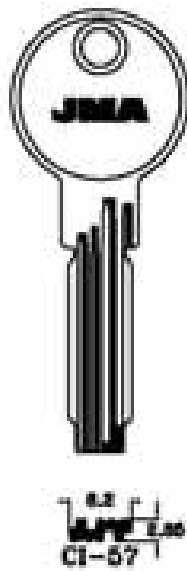
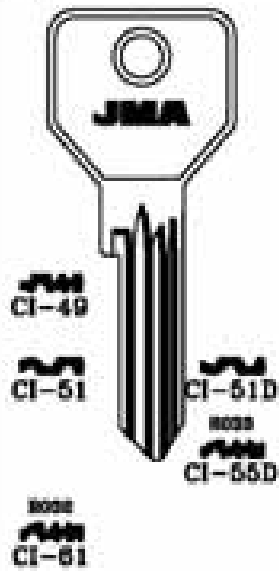

CISA (I)

CLARK FORK L.
(USA)

CLASSIC

CLAUSOR (E)

CLEMSA (E)

COH/CO (RUS)

PARA:
FOR: CLARK FORK L.

CLASSIC

CLAUSOR

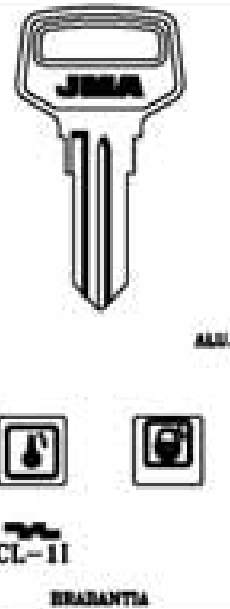
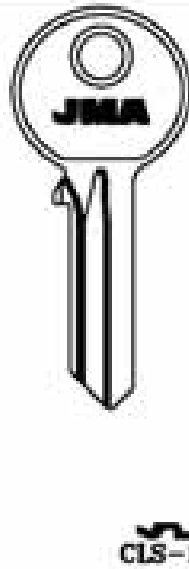
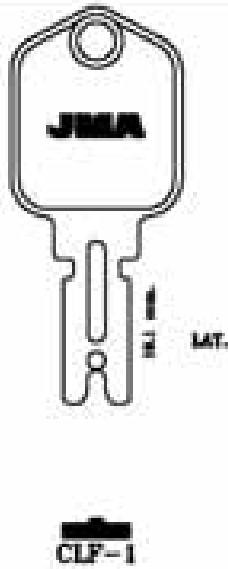

PARA:
FOR: CLEMSA

COH/CO

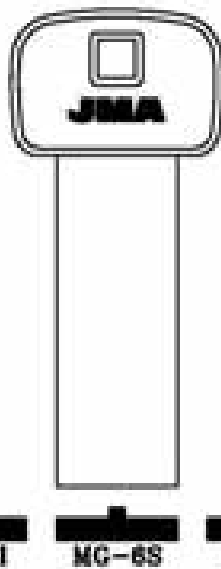

PLAS.

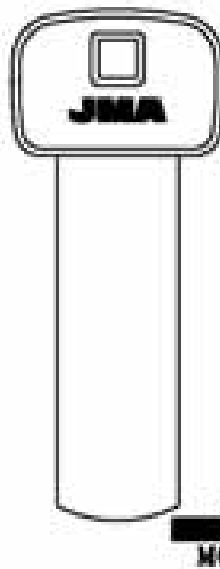

PLAS.

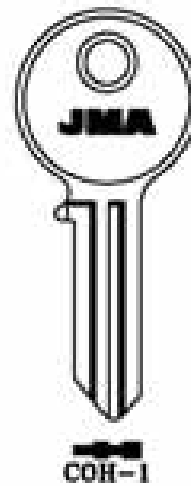

COH/CO

Copyright by
Magnum Altesa S.A.
2010

JMA

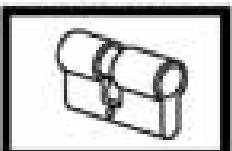



35





PARA-FOR:

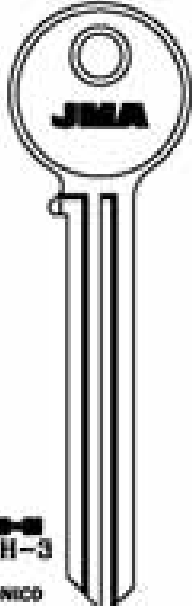

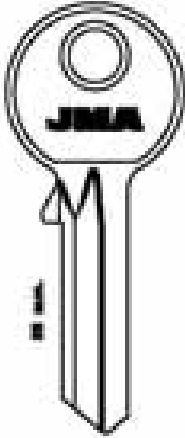

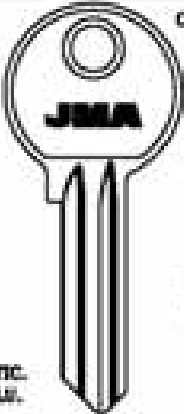
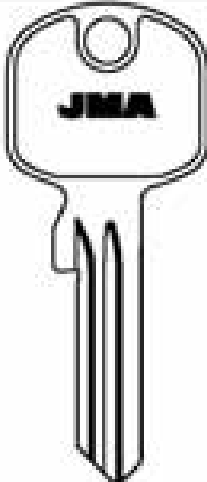
СОНИКО (RUS)

COM (D)

CORBIN (I)

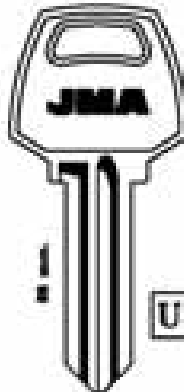
<p>PARA: FOR:</p> <p style="text-align: center;">СОНИКО</p> <div style="text-align: center;">  <p>COH-3 SONICO</p> </div>	<div style="text-align: center;">  <p>COH-4</p> </div>	<p style="text-align: center;">COM</p> <div style="text-align: center;">  <p>COM-1D</p> </div>
---	--	--

<p>PARA: FOR:</p> <div style="text-align: center;">  <p>COR-11</p> </div> <p>• NTIC. • ALI.</p>	<p style="text-align: center;">CORBIN</p> <p>ALUFORM CRC-CANBDA COM EBCO EUROFORM EBCO HESTE INDEPTERT KAVE LITTO MERMER MUNDA NEMEP NOVOFORM STENKLEK SUL THONE VERSCO ZACE</p> <p style="text-align: center;">COR-18D</p> <p style="text-align: center;">COR-48 COR-19D</p> <p style="text-align: center;">COR-49 COR-21D</p> <p style="text-align: center;">COR-89 COR-22D</p> <p style="text-align: center;">COR-11 COR-1D</p> <p style="text-align: center;">COR-80 COR-36D</p> <p style="text-align: center;">COR-3 COR-3D</p> <p style="text-align: center;">COR-79 COR-78D</p>	<div style="text-align: center;">  <p>COR-1GD</p> </div> <div style="text-align: center;">  <p>COR-21</p> </div> <div style="text-align: center;">  <p>COR-2D</p> </div> <div style="text-align: center;">  <p>COR-16D</p> </div> <p style="text-align: center;">EBCO-KAVE-LITTO-NEMEP</p>
---	--	---

<p>PARA: FOR:</p> <div style="text-align: center;">  <p>COR-7</p> </div> <p style="text-align: center;">COR-8</p>	<div style="text-align: center;">  <p>COR-9</p> </div> <p style="text-align: center;">COR-10</p>	<div style="text-align: center;">  <p>COR-11</p> </div> <p style="text-align: center;">COR-11D</p> <p style="text-align: center;">MASTER</p>	<div style="text-align: center;">  <p>COR-12</p> <p>I A L B D A L B E A L B</p> <p style="text-align: center;">COR-13 COR-13D</p> <p style="text-align: center;">COR-72</p> <p style="text-align: center;">EUROPARTNER</p> </div>
--	---	--	---

Copyright by
Alejandro Allina S.A.
2010

JMA

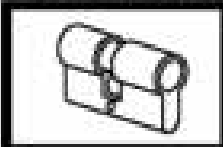

36

PARA:
FOR:

CORBIN

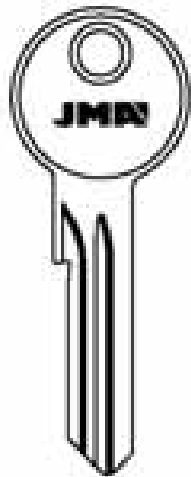

627
COR-64

650
COR-65

658
COR-66

COR-67

COR-68

COR-71



COR-17D

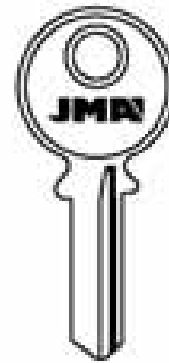

COR-20 COR-20D

COR-15D COR-73 COR-74

PARA-FOR:

CORBIN (I)

PARA:
FOR:

CORBIN



COR-20/25



COR-23D



COR-24
ORANGE-O-MATIC



COR-25I COR-25
SELMANN

PARA:
FOR:

CORBIN

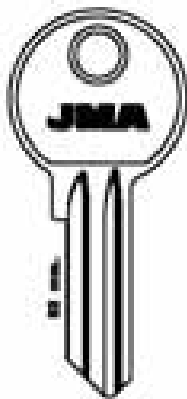

— I AL 7
— S AL 7
COR-26

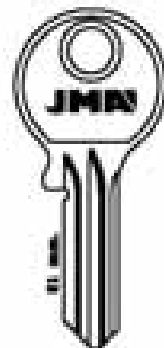

COR-27D

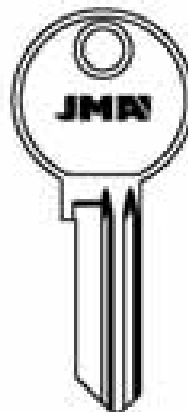

COR-28

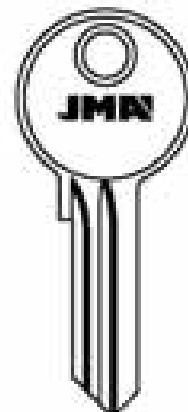

COR-29D

ESCO - BONDEN - KAPE - NUORA

Copyright by
Algebra Almas S.A.
2018

JMA

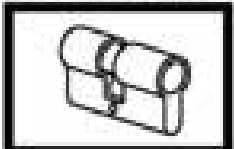

37

PARA-FOR:

CORBIN (I)

PARA-FOR: **CORBIN**

COR-30: 1 AL 9, 1 AL 7, 2 AL 7
 COR-31: CCL
 COR-32
 COR-33
 COR-34: LAT.

PARA-FOR: **CORBIN**

COR-35: ACE, LAT., AUS
 COR-37: IPAM
 COR-40: DAL
 COR-50/501 COR-50/50: MEXICO-DAL





PARA-FOR: **CORBIN**



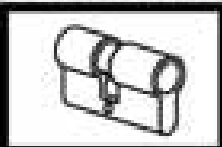

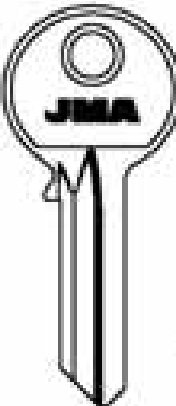
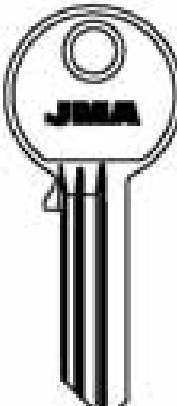



COR-70D
 COR-77: LAT.
 COR-78
 COR-114

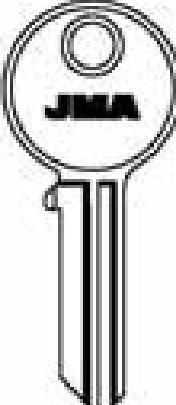
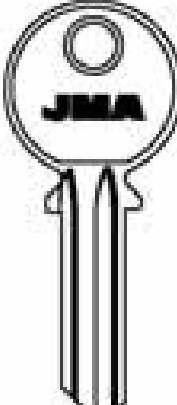
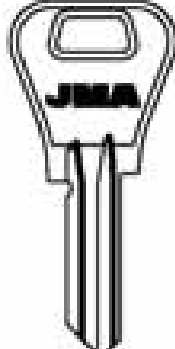







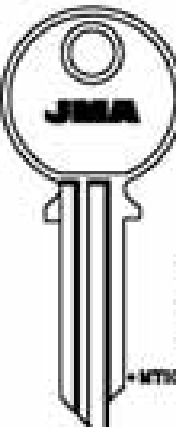
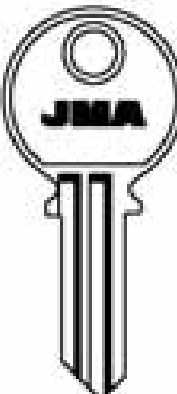
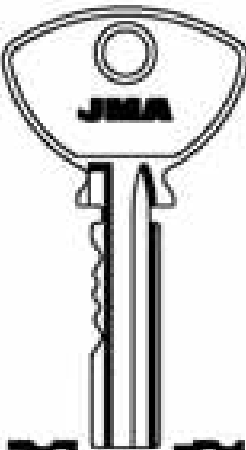

Copyright by
Algebra Altesa S.A.
1978

JMA



PARA FOR:	CORONA	COTICO	CRAZY LOCKS	PARA-FOR:
				CORONA (D)
				COTICO (D)
				CRAZY LOCKS (RC)
				CUBELLS (E)
				CVL (E)
				DAD (F)
	 CO-1D	 CO-M	 CLK-1	
	BIB-BURG-DOCO-GERNO-IRON			
		IRON		

PARA FOR:	CUBELLS	CVL	
			
		LAT. ALD. COL.	LAT. ALD.
	 CUB-1	 CVL-11	 CVL-1D
		SERIALLES	
		 CVL-21	 CVL-2D
		UCEM	
		 CVL-31	 CVL-3D

PARA FOR:	CVL		DAD
			
	*PUL. *LAT. *ALD. *MYC.(D-C)		ALP.
	 CVL-4	 CVL-6	 DAD-11
		 CVL-8D	 DAD-1D
	 *CVL-51		 DAD-21
	 CVL-5D*		 DAD-2D
	ALMON-CAYS-CAROLA-EURO PERICO-11-PP-QCN		BECAVEX

Copyright by
Algebra Almas S.A.
2018

JMA

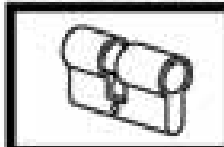

39









PARA-FOR:

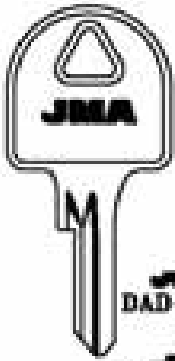



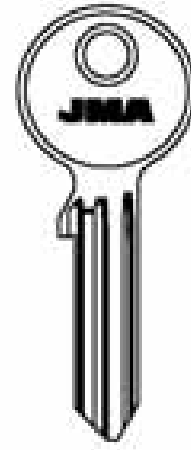

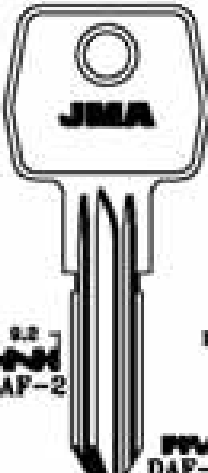

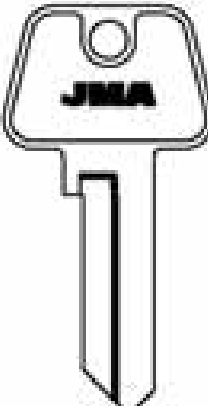
DAD (F)

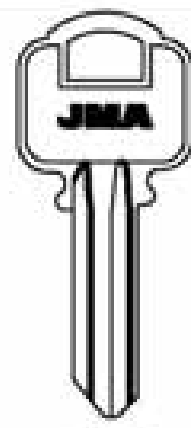

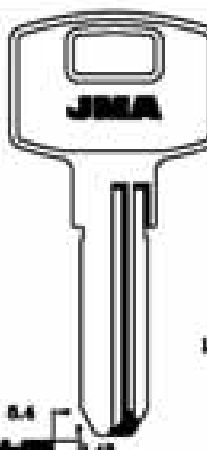

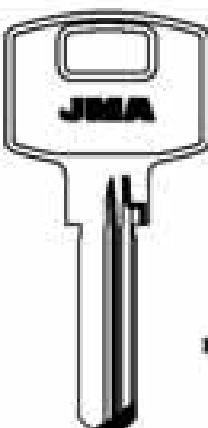

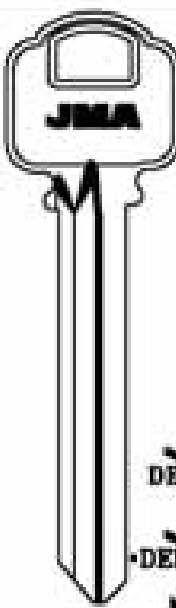

DAF (TR)

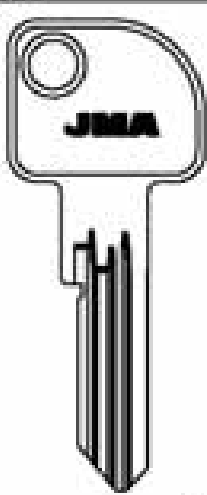
DEFA (N)

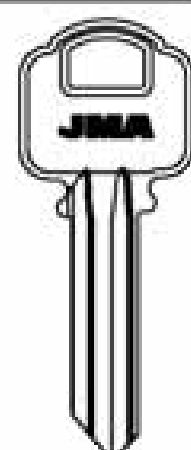
DEKABA (BG)

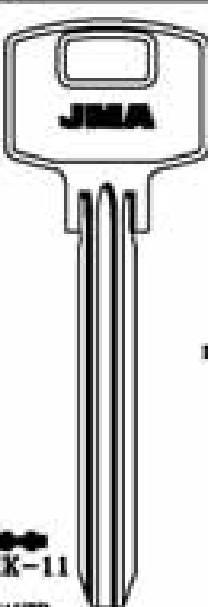
PARA-FOR:	DAD	DAF	DEFA
	    ANPE-DECATYELX	    LAT. LAT.	 DEF-1D

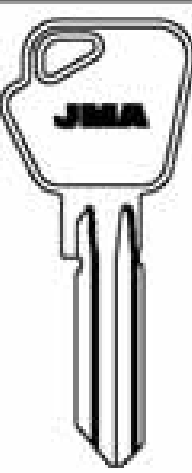
PARA-FOR:	DEKABA			
	  MAUER	  MAUER	  MAUER	  MAUER













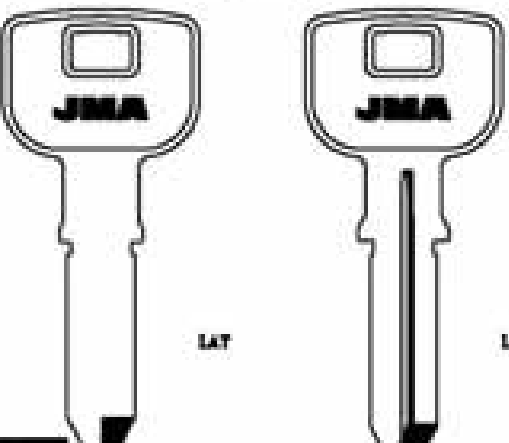







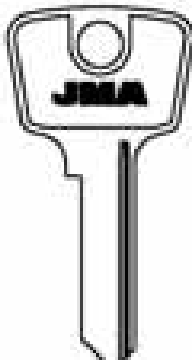

PARA-FOR:	DEKABA			
	  MAUER	  MAUER	  MAUER	  MAUER

Copyright by
Alpandre Altina S.A.
2019

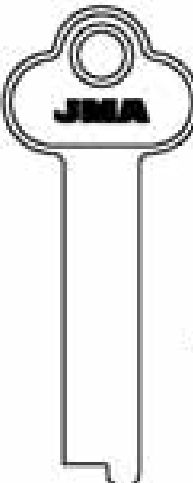
JMA

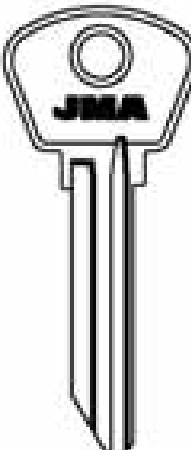

40

<p>PARA FOR: DELAPORTE</p>   <p>0041-0500 DLP-1</p>  <p>DLP-2</p> <p>0048-0054</p>	<p>DELCA</p>  <p>LAT</p>  <p>DLC-1</p>  <p>DLC-2</p> <p>GEVY</p>  <p>DLC-3</p> <p>GEVY</p>	<p>PARA-FOR:</p> <p>DELAPORTE (F)</p> <p>DELCA (GR)</p> <p>DEXTER (I)</p> <p>DIAMOND (RC)</p> <p>DIEBOLD (D)</p> <p>DIMITROVGRAD (RUS)</p> <p>DOM (D)</p>	
<p>PARA FOR: DEXTER</p>  <p>ALL.</p>  <p>DX-5</p>  <p>DX-5D</p>  <p>DX-5</p>  <p>DX-5D</p>	<p>DIAMOND</p>   <p>DIA-1</p>  <p>DIA-2</p>		
<p>PARA FOR: DIAMOND</p>   <p>DIA-3</p>	<p>DIEBOLD</p>   <p>DIE-1</p> <p>LAT.</p>	<p>DIMITROVGRAD</p>   <p>DM-1</p>	<p>DOM</p>  <p>• ALL. • LAT. • FINE.</p> <p>BYT DAB ESAPE FECOR HAEPFEL HEKNA HUWIL MECALUX METROH MLM RENZ RUKA SCHEDEL STO</p>  <p>DOM-11</p>  <p>DOM-1D</p> <p>ED 001-008 SA 0001-0000 SA 0001-0000 ID 001-004</p>

Copyright by
Alejandro Altuna S.A.
2010

JMA

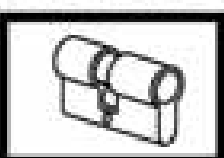

© 2010 JMA. Reservados todos los derechos y demás disposiciones legales que rijan en México. All rights reserved. All other legal provisions that apply in Mexico.

PARA-FOR:

DOM (D)

PARA-FOR: **DOM**



BTY
 DAB
 EMARF
 FICOR
 HAEPELE
 HERNIA
 HUWIL
 MICALIX
 METEOR
 MLM
 RENE
 RUKA
 SCHLIGEL
 STY

ED 001-000
 SA 0001-0000
 SA 0001-0000
 LD 001-004
 DOM-1D.P

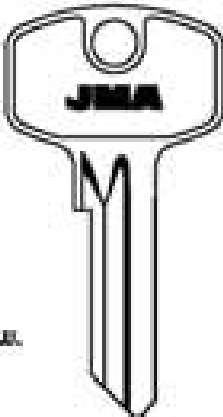

ALL

III
 DOM-2D
 MORSAUX-STUY



C
 1001-1000
 C
 1001-1000
 CL
 001-000
 CP
 001-000
 DOM-3I
 DOM-3D
 DOM-4
 DOM-4D
 DOM-8D
 CHERY

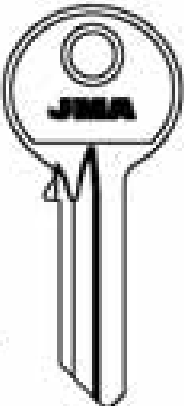

COL

EC
 I
 LISTA
 DOM-5D
 STYGA-STUY-VISI

PARA-FOR: **DOM**



BN
 001-100
 00100-00700
 00701-00040
 DOM-6I
 DOM-6D
 BARRO-IDEAL-TM

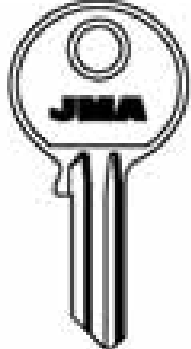

EY
 0001-0040
 GB
 0001-1000
 HC
 0001-0000
 DOM-7I
 DOM-7D
 BODMANN



EY...1-0040
 GB...1-1000
 FT...1-1000
 CQ...001-400
 ...1-1000
 DOM-9
 DOM-9D
 DOM-38D
 NOBO

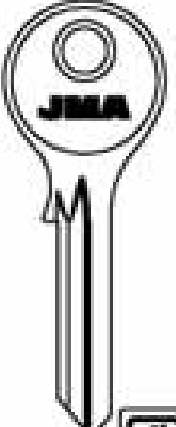

I
 DOM-10D

PARA-FOR: **DOM**



CWS
 HAEPELE
 HERNIA
 HUWIL
 MLM
 MENOVA
 METEOR
 RUKA
 SONJET
 STY

FS 01-00
 FC 001-010
 AA 001-100
 BA 01-00
 CF 001-140
 DS 001-140
 EA 01-04
 LD 01-07
 ID 001-000
 DOM-11I
 DOM-11D

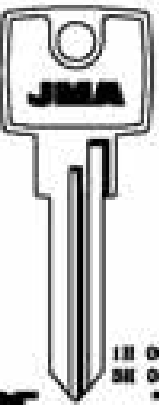

IH 0001-4000
 SH 0001-0000
 DOM-12
 DOM-12D
 ARPA
 IH 0001-4000
 SH 0001-0000
 DOM-48
 NOBO



DC...1-1000
 E...1-00
 GD...1-1000
 GE...1-1000
 SE...1-000
 DOM-13D

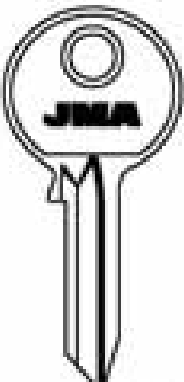

FA-CZ
 0001-0040
 DOM-14D

Copyright by
Alphatex S.A.
1978

JMA



42

PARA:
FOR:

DOM

PARA-FOR:

DOM (D)



DOM-15D



ALP.
LAT.

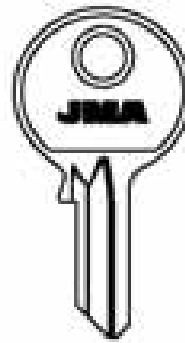

DOM-16D

DOM-41D



DOM-171

CORBIN-EMRART

DOM-16D

PARA:
FOR:

DOM

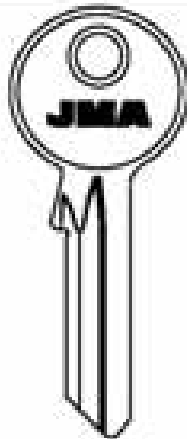

DOM-20D

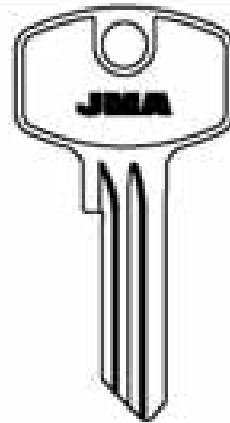

DOM-21D

CORBIN

DOM-45

DOM-46D

DOM-44D

PARA:
FOR:

DOM



ALP.



DOM-22

ARCU

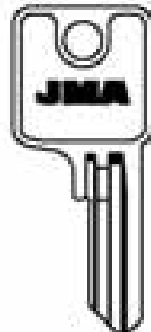

DOM-25D

DOM-49D



ED 001-000
SA 0001-0000
SA 0001-0000
ID 001-004
DOM-26 DOM-26D

Copyright by
Allegre Almas S.A.
2010

JMA

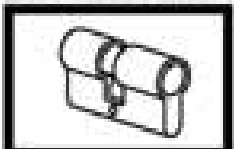

43

PARA-FOR:

FOR:

DOM

DOM (D)

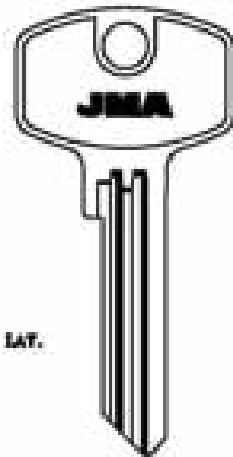

LAT.

- DOM-27D/2 DOM-27D/9 DOM-27D/16 DOM-27D/23 DOM-27D/30
- DOM-27D/3 DOM-27D/10 DOM-27D/17 DOM-27D/24 DOM-27D/31
- DOM-27D/4 DOM-27D/11 DOM-27D/18 DOM-27D/25 DOM-27D/32
- DOM-27D/5 DOM-27D/12 DOM-27D/19 DOM-27D/26 DOM-27D/33
- DOM-27D/6 DOM-27D/13 DOM-27D/20 DOM-27D/27 DOM-27D/34
- DOM-27D/7 DOM-27D/14 DOM-27D/21 DOM-27D/28 DOM-27D/35
- DOM-27D/1 DOM-27D/8 DOM-27D/15 DOM-27D/22 DOM-27D/29 DOM-27D/36

- DOM-27D/37 DOM-27D/44 DOM-27D/51 DOM-27D/58
- DOM-27D/38 DOM-27D/45 DOM-27D/52 DOM-27D/59
- DOM-27D/39 DOM-27D/46 DOM-27D/53 DOM-27D/60
- DOM-27D/40 DOM-27D/47 DOM-27D/54 DOM-27D/61
- DOM-27D/41 DOM-27D/48 DOM-27D/55
- DOM-27D/42 DOM-27D/49 DOM-27D/56
- DOM-27D/43 DOM-27D/50 DOM-27D/57

PARA-FOR:

DOM

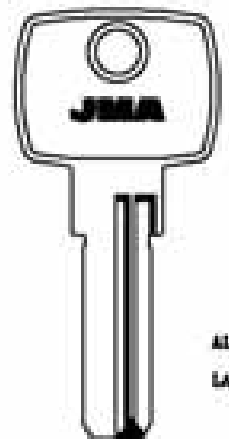
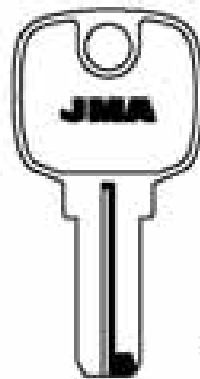
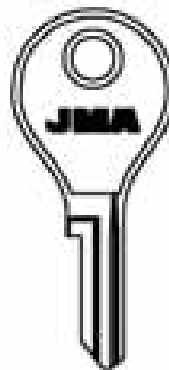

ALP.

ALP.
LAT.

DOM-28

GE...-500
DOM-29

DOM-30

DOM-31

SAO

MORCAIXE

CORNÉ-ENLART

Copyright by
Alejandro Allina S.A.
2018

JMA

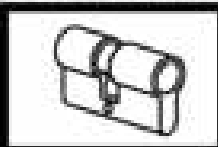

44

PARA:
FOR:

DOM

PARA-FOR:

DOM (D)

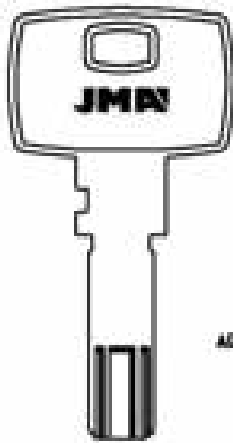

ALP.



DOM-32

CORBIN-EWALANT

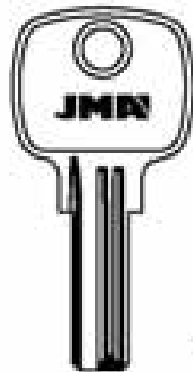

ALP.



DOM-33

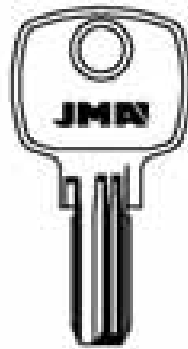

ALP.



DOM-34

DOM-39



ED 001-022
SA 0001-0200
SA 0001-0200
ID 801-804

DOM-35 DOM-35D

DOM-51

PARA:
FOR:

DOM

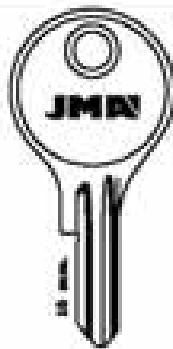

ED 001-022
SA 0001-0200
SA 0001-0200
ID 801-804

DOM-36 DOM-36D



ED 001-022
SA 0001-0200
SA 0001-0200
ID 801-804

DOM-37 DOM-37D

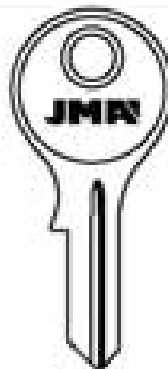

DOM-38D

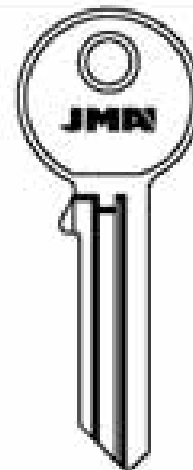

DOM-40D

PARA:
FOR:

DOM

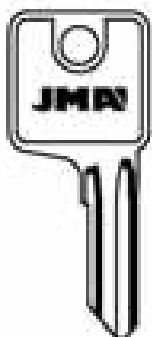

DOM-42
FLANCO-REDONA-ROD0
PERCHALUS

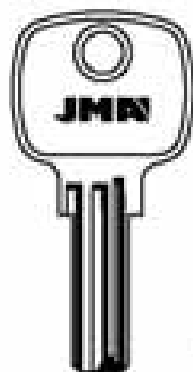

ALP.



DOM-43

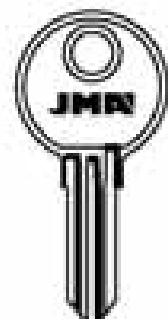

DOM-52

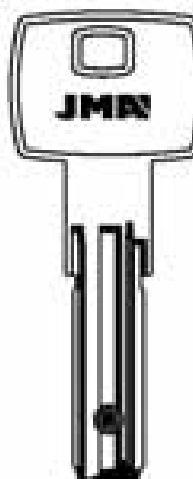

ALP.



DOM-B1

CORBIN-875

Copyright by
Algebra Almas S.A.
2018



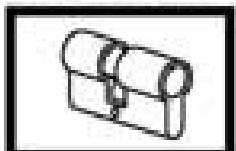

JMA





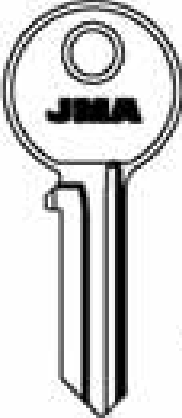
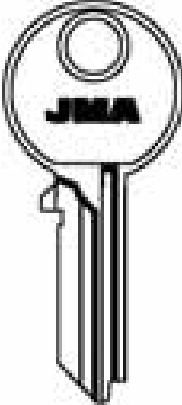
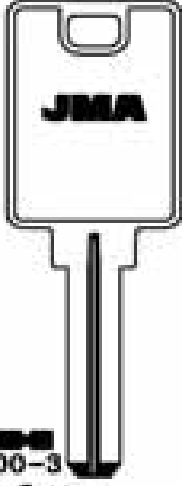
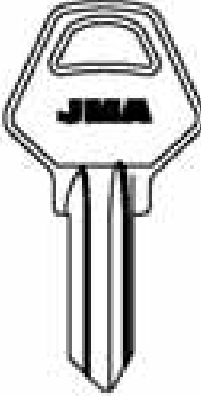





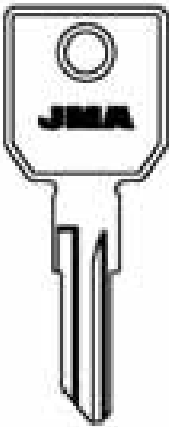



45

PARA-FOR:

- DOMINION (USA)**
- DOMUS (I)**
- DOUBLE CIRCLE (RC)**
- DURALOCK (USA)**
- EAG (D)**
- ECM (I)**

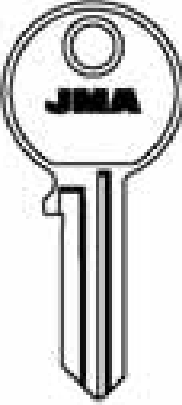
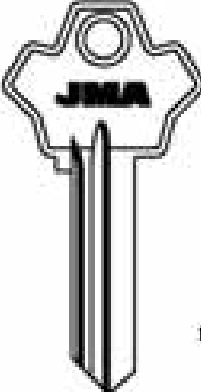
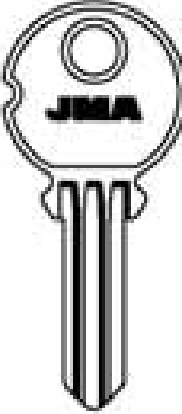
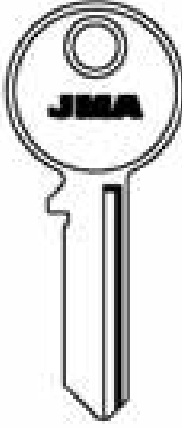
<p>PARA-FOR: DOMINION</p>	<p>DOMUS</p>		
 <p>LAT.</p>		 <p>ALP.</p>	
 DO1-1 <small>PETERBORO</small>	 DO-21	 DO-3 DO-4	 DO-5 DO-5D

<p>PARA-FOR: DOMUS</p>	<p>DOUBLE CIRCLE</p>		
			
 DO-7	 DC-10	 DC-20 <small>THE CIRCLE</small>	 DC-3

<p>PARA-FOR: DOUBLE C.</p>	<p>DURALOCK</p>	<p>EAG</p>	<p>ECM</p>
	 <p>LAT.</p>		
 DC-4D	 DUR-1D	 EG-2 EG-1	 EC-1 EC-1D

Copyright by
Alpex S.p.A.
2018

JMA

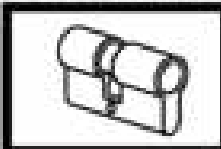

PARA:
FOR:

EIKO

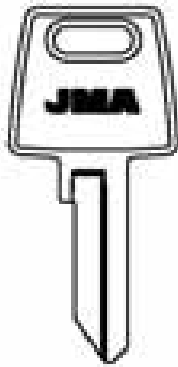

EI-1D

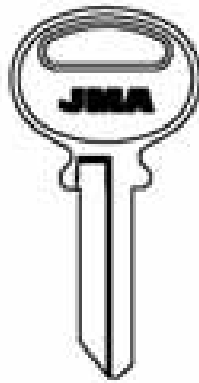

EI-2D

CDA

ELZETT

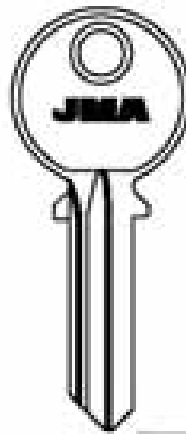

ELZ-1D

TREFFENTHAL-TUTS



ELZ-2

ELZ-4

ELZ-3D

ELZ-4D

ELZ-5D

PARA-FOR:

EIKO (J)

ELZETT (H)

EMKA (F)

EP PINSON
(GB)

PARA:
FOR:

ELZETT

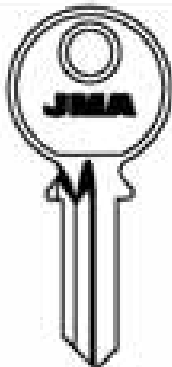

ELZ-8D

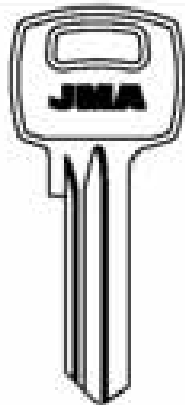

ELZ-8D

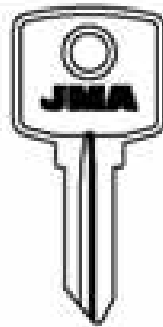

ELZ-9

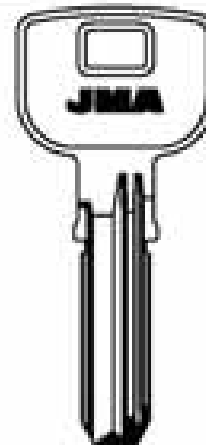

LT.

ELZ-10¹ ELZ-10D

PARA:
FOR:

ELZETT

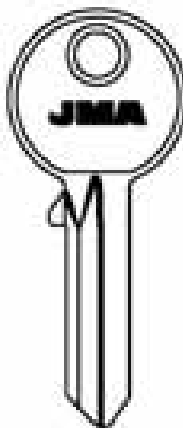

ELZ-11D

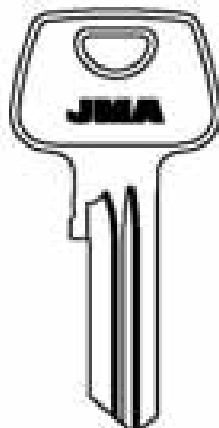

ELZ-12

ELZ-12D

EMKA

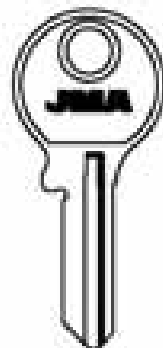

EMK-1

EP PINSON

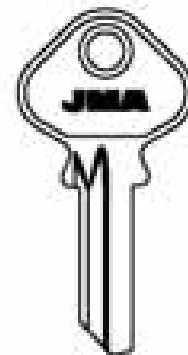

EP-1D

Copyright by
Allegretto Altman S.A.
2010







JMA



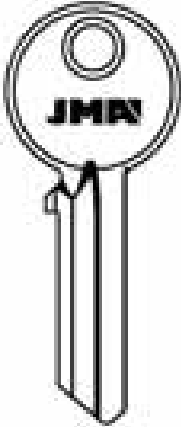
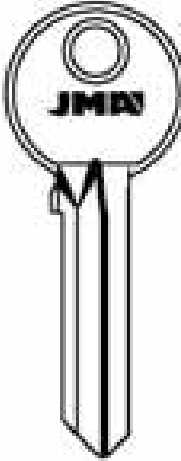
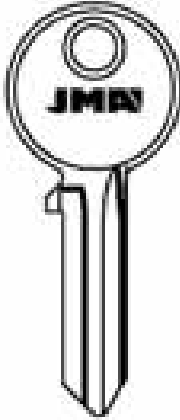







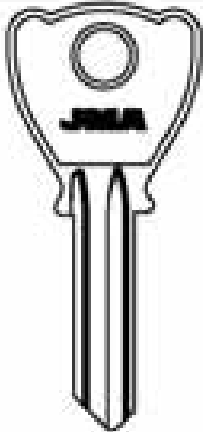
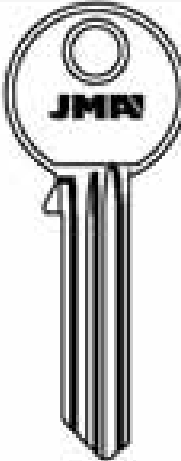
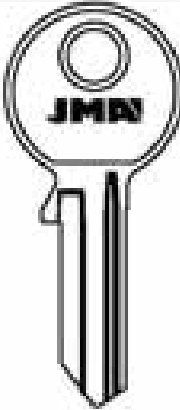
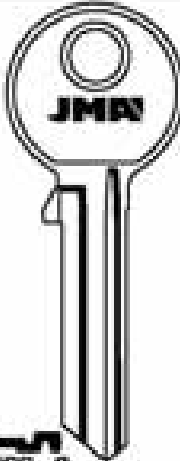



47

PARA-FOR:

- ERA GB)
- ESA (E)
- ESLA (GB)
- ESS (D)
- ETAS (GB)
- EUREKA (I)
- EURO BOX
- EURO LOCKS (B)

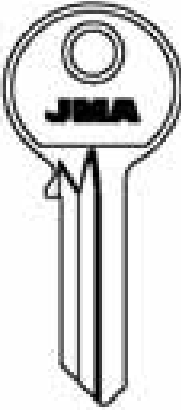
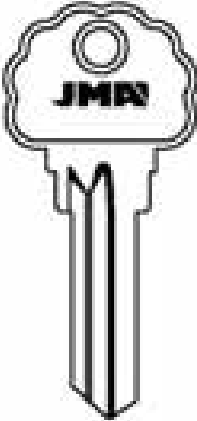
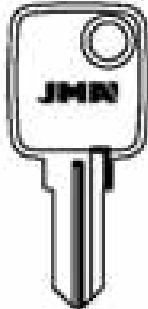
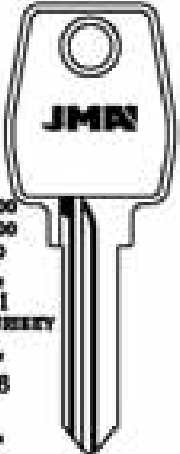
	ERA			
				LAT.
 ER-1D	 ER-2D	 ER-3	 ER-4D	

	ESA	ESLA	ESS		
					
 ES-11	 ES-1D	 ESL-1	 ESL-1D	 ESS-1	 ESS-3
 ESS-2		 ESS-4			

	ETAS	EUREKA	EURO BOX	EURO LOCKS
				
 ETS-1D	 EUR-1D	 EUB-1	 EU-10D	

47001-48000
 88000-87000
 1801-1400

 EU-1
 EMMA-SECURITY

EU-6

EU-9

Copyright by
 Alejandro Allina S.A.
 2018

JMA



48

PARA:
FOR:

EUROLOCKS

PARA-FOR:

EUROLOCKS
(B)

EVERGOOD
(RC)

EVVA (A)

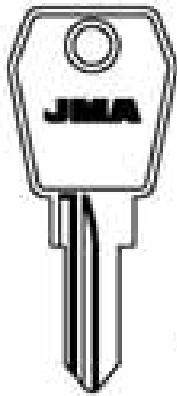

ALL

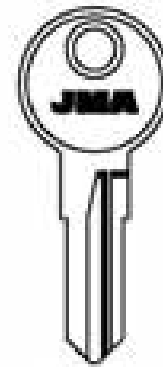

85001-87000

EU-2

PARMA

EU-3

450-6104

EU-4

400-6304

EU-4D

EU-11

PARA:
FOR: EUROLOCKS

EVERGOOD



EU-8D

LAF



EVE-1

ARREGUI

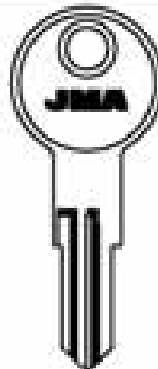

EVE-2D

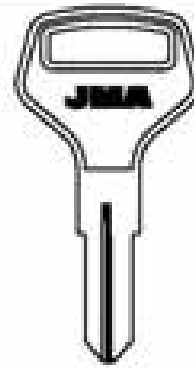

EVE-3D

PARA:
FOR: EVERGOOD

EVVA

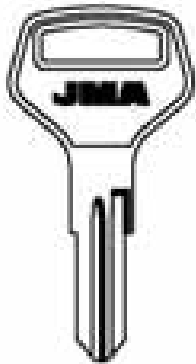

EVE-4



EV-2I

EV-3I

EV-1

EV-2

EV-3D

EV-13D

ELCA

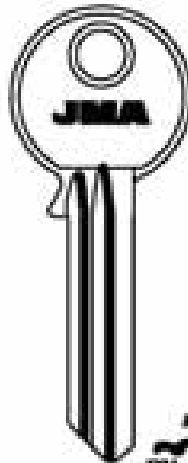

EV-10

EV-4D



EV-6D

EV-7D

EV-8D

EV-9D

ELCA-TETEM





Copyright by
Algebra Almas S.A.
2010





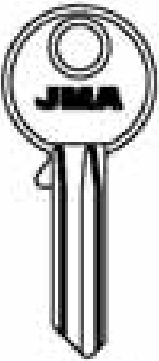

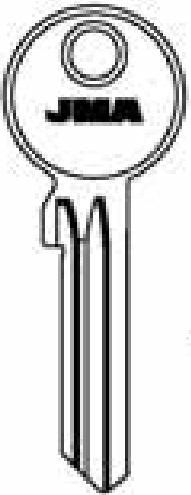
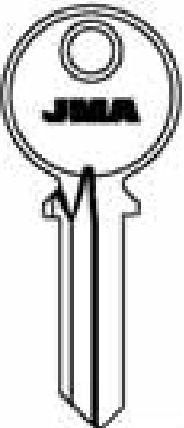

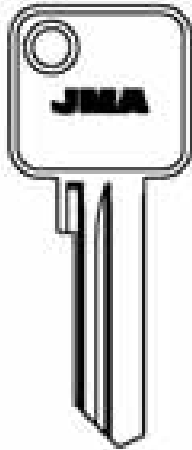
JMA

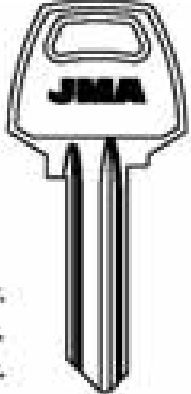





PARA-FOR:

- EVVA (A)
- EXCEL (F)
- EXPRES (PL)
- EZCURRA (E)
- FAB (CZ)

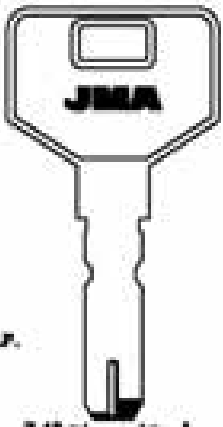
PARA: FOR:	EVVA	EXCEL	EXPRES
	  E0 ...101-1479 E1 ...8081-8479 EV-11 EV-11D	 LAT.   EX-1D BILLEN	 EXS-1D

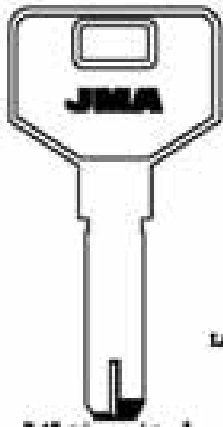
PARA: FOR:	EZCURRA					
	 • ALI. • LAT. • PSL.					
	 EZ-11	 EZ-10	 EZ-31	 EZ-30	 EZ-41	 EZ-40

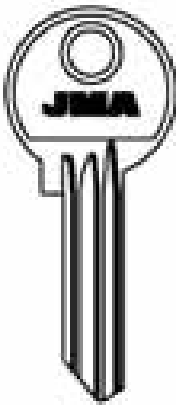
PARA: FOR:	EZCURRA	FAB	
	 ALP. 7.45 1 3.5 EZ-DS10 CAS  EZ-DS10E	 LAT. 7.45 1 3.5 EZ-DS15  EZ-DS15R	 • 3 FB-3 • 19 FB-19 • 20 FB-20 • 11 FB-1 • 22 FB-22 • 23 FB-23 • 24 FB-24 • 21 FB-21 • 25 FB-25 • 31 FB-31

Copyright by
Alpargatas Alltara S.A.
1999

JMA

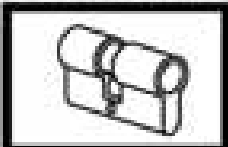

50

PARA:
FOR:

FAB

PARA-FOR:

FAB (CZ)

FAC (E)

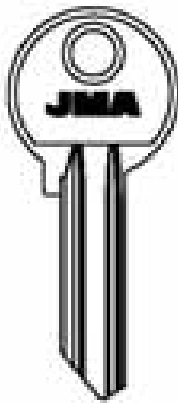

- 10X
FB-4
- 11X
FB-5
- 20
FB-6
- 21
FB-7
- 22
FB-8
- 24
FB-9
- 25
FB-10
- 26
FB-11
- 28
FB-12
- 10X
FB-26
- 14X
FB-29

+ WTC.(T)

- 10X
FB-32
- 12X
FB-34
- 11X
FB-35
- 2
FB-38
- 14X
FB-41
- PR20
+FB-17
- PR22
FB-14
- PR24
FB-15
- PR26
+FB-27
- PR28
FB-18
- PR21
FB-28

- 23
FB-21
- 25
FB-20
- 22
FB-8

- PR23
+FB-13
- PR25
FB-16

PARA:
FOR:

FAB

FAC

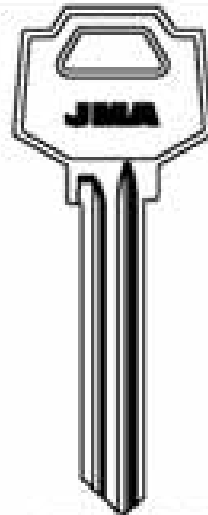
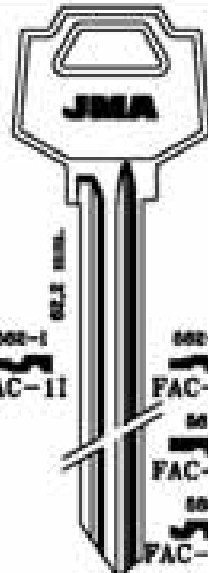
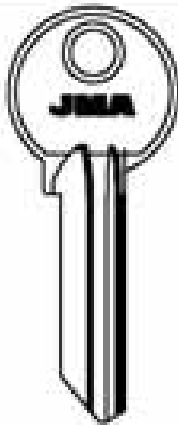

FB-33

FB-39

500-1
FAC-11

500-0
FAC-1D

501
FAC-8D

502
FAC-12D

FAC-21 FAC-20

PARA:
FOR:

FAC

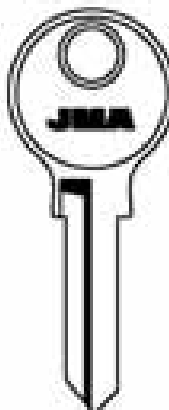

LAT.
ALL.

FAC-31 FAC-3D

FAC-4D

503
FAC-5D

505
FAC-9D

508
FAC-8D

571
FAC-10D

Copyright by
Allegre Almas S.A.
2018

JMA

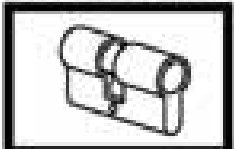

51

PARA-FOR:

FAC (E)

FAINER (P)

FALCON (USA)

FAMA (BR)

PARA-FOR: **FAC**

- ALL.
- LAT.
- FBI.

366
FAC-7D
377
• FAC-11D

- ALL.
- LAT.
- FBI.

377
FAC-13D
377
FAC-15

366 mm.
FAC-14D

ALL.

FAC-18

PARA-FOR: **FAC**

AP.

34
FAC-19

FAC-20

FAC-21

FAC-21D

FAC-22D

PARA-FOR: FAC	FAINER	FALCON	FAMA
<p>LAT.</p> <p>34 FAC-23</p>	<p>FAIN-11</p> <p>34</p>	<p>LAT.</p> <p>FAL-1D</p> <p>FAL-2D</p>	<p>FAM-1</p>

Copyright by
Alejandro Allier S.A.
2018

JMA

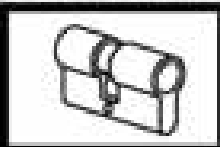









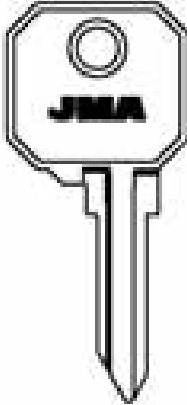

PARA-FOR:

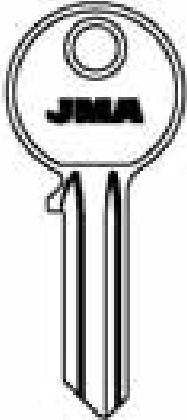





**FEDERAL
(USA)**



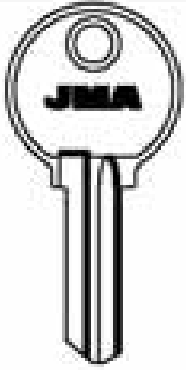
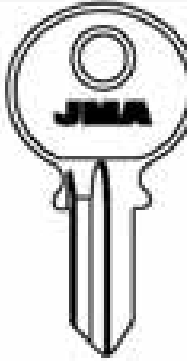
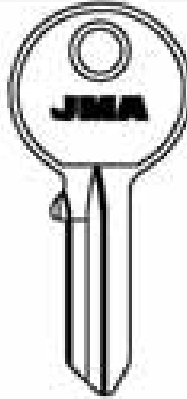

**FERONERIA
(RU)**

F.F. (I)

FICHET (F)

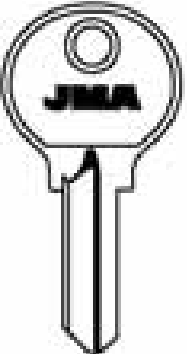
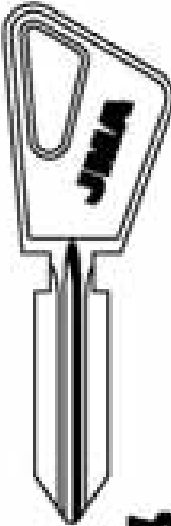
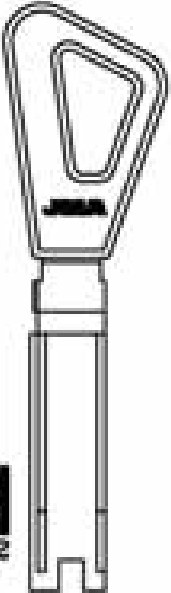
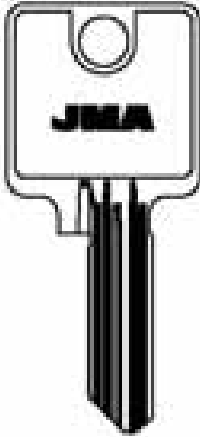
PARA-FOR:	FEDERAL	FERONERIA	F.F.	
				
	 FED-3	 FER-1	 FF-1  FF-1D  FF-3 GUARDIAN	 FF-2  FF-2D  FF-10D GUARDIAN

PARA-FOR:	F.F.			
				
	 FF-5D	 FF-6  FF-11	 FF-7D	 FF-8D

PARA-FOR:	F.F.	FICHET		
				
	 FF-9D	 FIC-1 SUSPENSOR	LAT.  FIC-2	 FIC-5

Copyright by
Alejandro Allier S.A.
2019

JMA



54

PARA:
FOR:

FICHET

PARA-FOR:

FICHET (F)

FIST (I)

FLORA (D)

FONTAINE (F)

FORT (F)

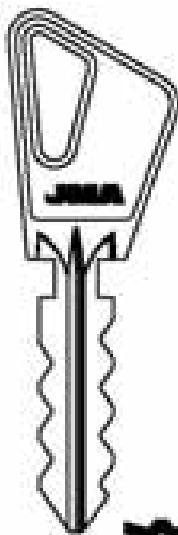

FIC-7

SURFENOR

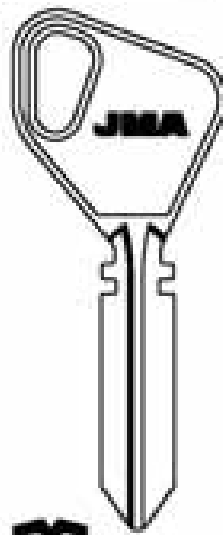

FIC-8

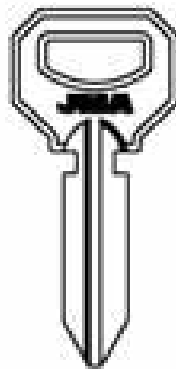

FIC-9

TECHOR

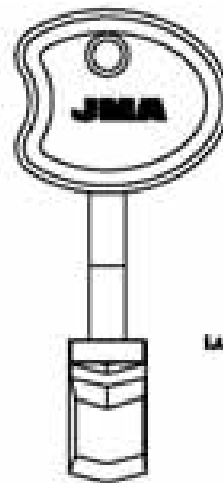

FIC-18

LAT.

PARA:
FOR:

FIST

FLORA

FONTAINE



FIS-1D

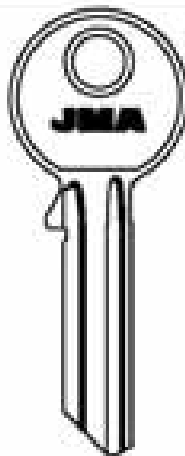

FLO-1 FLO-1D

FLORIS-HO-NORDWEST-SUMI

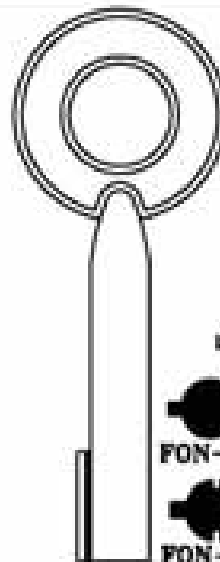

FON-1E

FON-6E

LAT.

PARA:
FOR:

FONTAINE

FORT

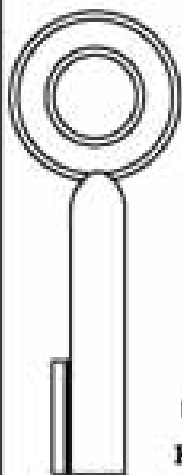

FON-2E

FON-4E

FON-5E

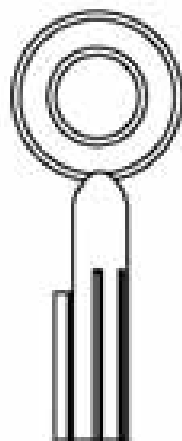

FON-3E

LAT.

PROGRES



FR-2

DAD



FR-4

FR-1D



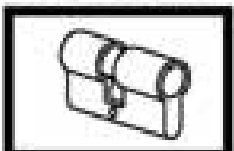

Copyright by
Allegretto Almon S.A.
2010





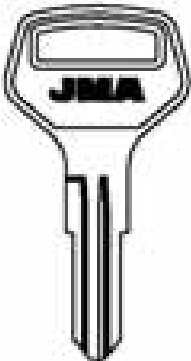

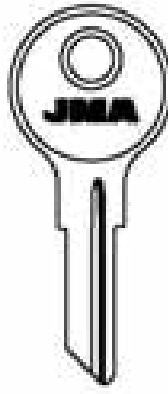
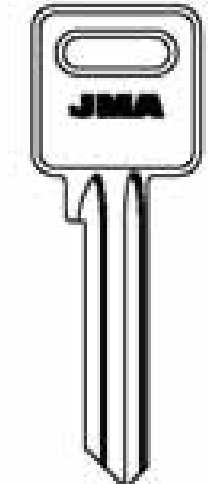

JMA

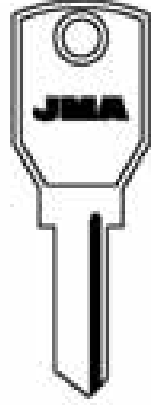

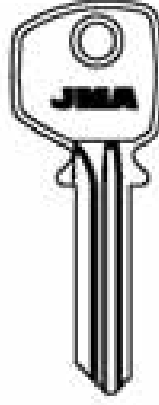
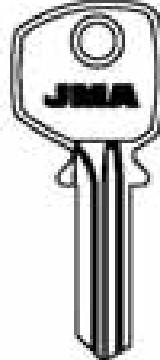
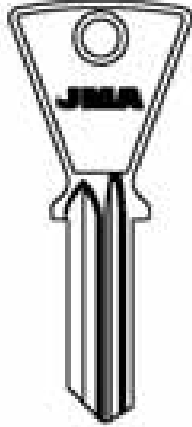





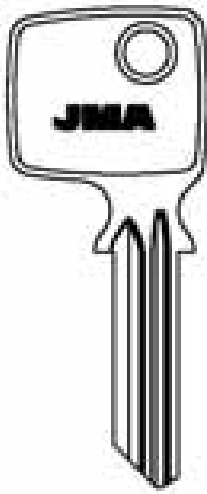

PARA-FOR:

- FORT (F)**
- FORTE (YV)**
- FORTIS (E)**
- FTH (F)**

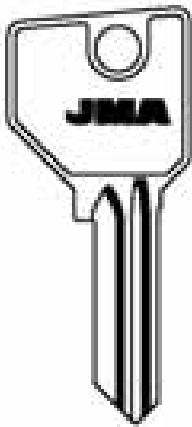
PARA-FOR:	FORT	FORTE
	  <small>ARROCI</small>	   

PARA-FOR:	FORTIS	FTH
	 	        

PARA-FOR:	FTH		
	 	  	 
			  <small>ALP.</small> COSEM-POWER-YALTES

Copyright by
Alpacare Alltara S.A.
1978

JMA



PARA:
FOR:

FTH

PARA-FOR:

FTH (F)

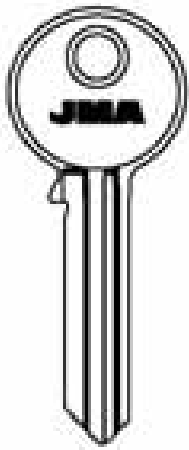

—A I AL B
FTH-9

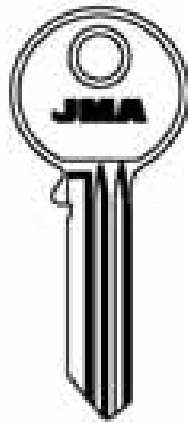

FTH-10



—D AL B
FTH-11D



FTH-12D

DES
BRO
CARAT
LARGO
BIC
BIC
TALE

FTH-21
CP-CIB-IFAM-JL-RCO-PROBAT
CIRC-CITY-SUF

PARA:
FOR:

FTH

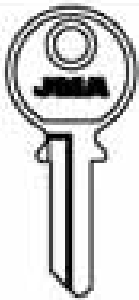

FTH-13D

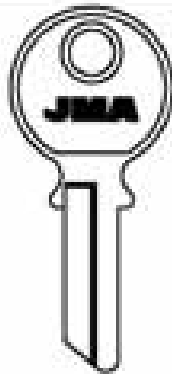

FTH-14D

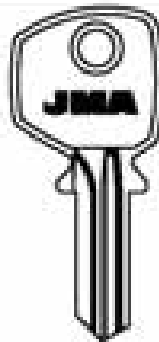

FTH-15



FTH-16

IFAM-KARO

ALP.

PARA:
FOR:

FTH

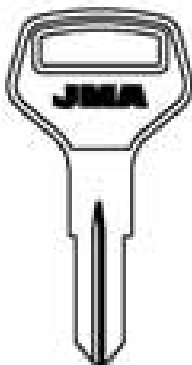

FTH-17D

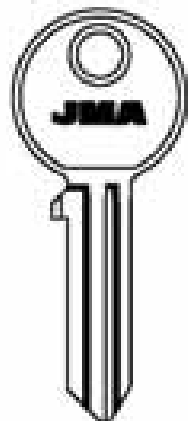

—A I AL B
FTH-18



FTH-19

FEDERAL

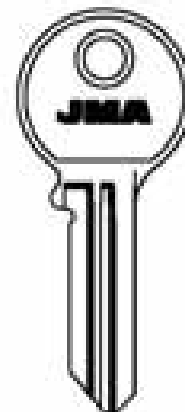

FTH-20D

HERACLES

Copyright by
Alejandro Allmon S.A.
2018

JMA

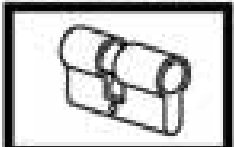

57





PARA-FOR:





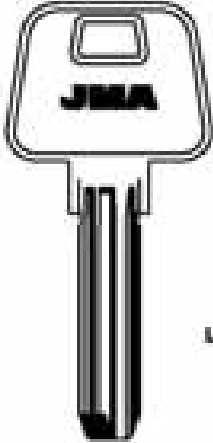
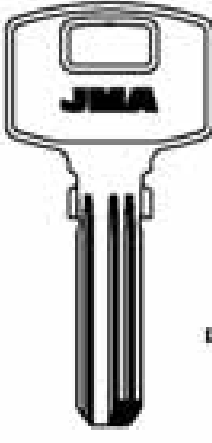
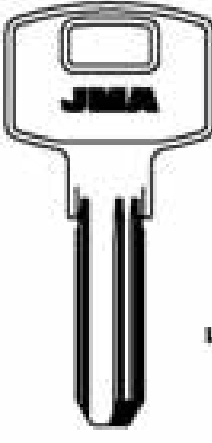
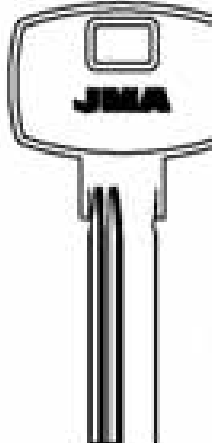

FTH (F)



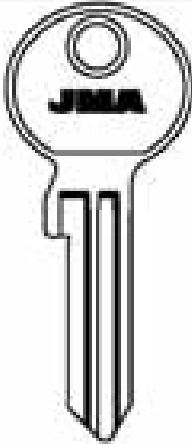
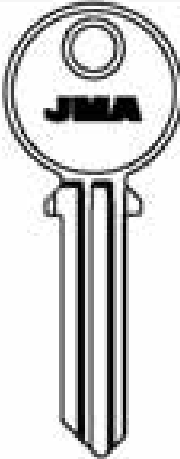

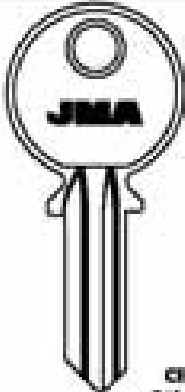



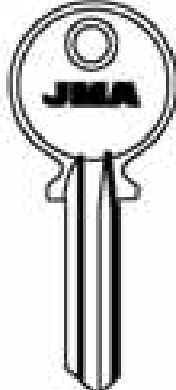

GABON (F)

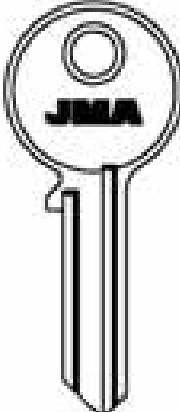
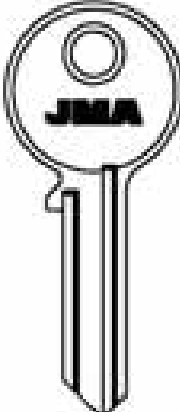
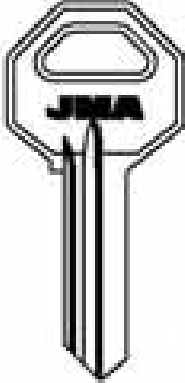
GAMMET (PL)

GATO (COL)

PARA-FOR:			
FTH			
			
LAT.	LAT.	LAT.	LAT.
 7.8 2.30 FTH-23 ATLANTIC	 8.3 FTH-24	 8.5 FTH-25	 8.7 FTH-26D SP

PARA-FOR:			GABON
FTH			
			
 FTH-27	 FTH-28	 8.55 FTH-29	LAT. CIG GALLUS MAXIGARD PICARDE SOS WINNER GAB-11 GAB-1D

PARA-FOR:	GABON	GAMMET	GATO	
				
 GAB-2 CIG-GALLUS-MAXIGARD PICARDE-SOS-WINNER	 GMT-1  GMT-2  GMT-30  GMT-40  GMT-5D EXPRES	 GAT-1	LAT.	 GAT-2D

Copyright by
Alquadró Altimex S.A.
1978

JMA



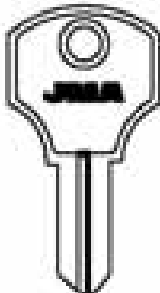
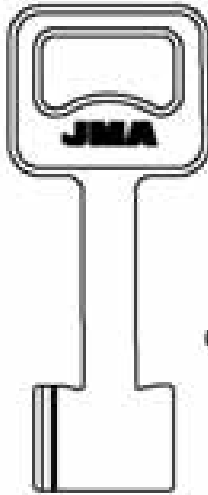
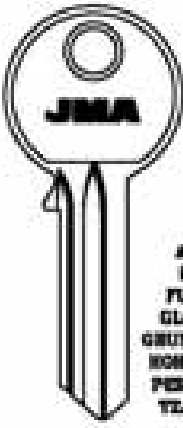
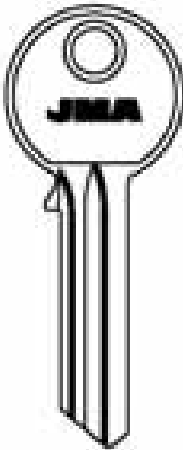

58

PARA: FOR:	GATO	GBZ	GE GE	
	 <p style="text-align: right;">LAT.</p> <p style="text-align: center;">GAT-3D</p>	 <p style="text-align: right;">LAT.</p> <p style="text-align: center;">GBZ-1</p>	 <p style="text-align: right;">LAT.</p> <p style="text-align: center;"> <small> ARUX FLEX GLOTTAL GRUNDMANN HOHRMANN PERONALIS TRAFER </small> GE-2 </p>	 <p style="text-align: right;">LAT.</p> <p style="text-align: center;"> <small> 500031-750007 </small> GE-3D <small>ALFA</small> </p>

PARA-FOR:

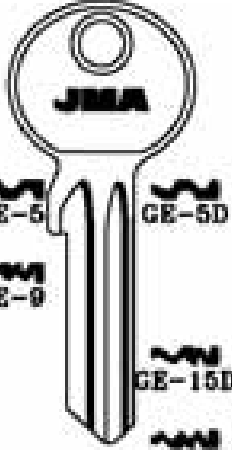
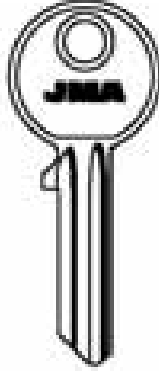
- GATO (COL)**
- GBZ (I)**
- GE GE (A)**
- GEBA (D)**
- GERA (D)**

PARA: FOR:					GE GE				
 <p style="text-align: right;">LAT.</p> <p style="text-align: center;"> <small> I...1001-1070 E...00-070 </small> GE-4D </p>	 <p style="text-align: right;">LAT.</p> <p style="text-align: center;"> <small> LABOFA-PERONALIS </small> GE-5 GE-5D GE-9 GE-15D GE-16D </p>	 <p style="text-align: right;">LAT.</p> <p style="text-align: center;"> <small> PERONALIS </small> GE-6 GE-6D </p>	 <p style="text-align: right;">LAT.</p> <p style="text-align: center;"> <small> MSS I... 00000-01000 GE-8 MSS I... 0100-10000 GE-7 </small> </p>						

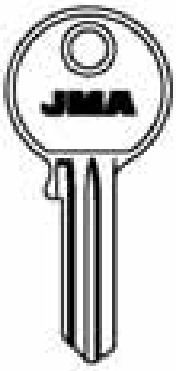
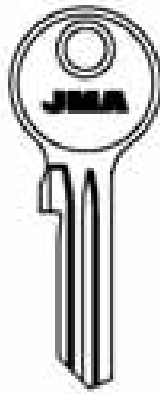
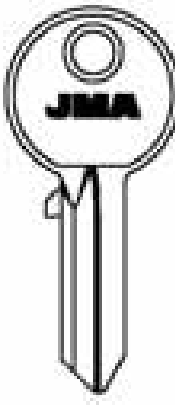
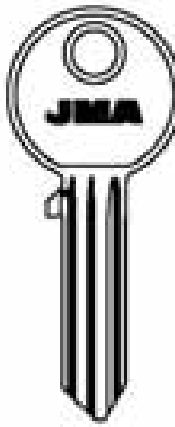
PARA: FOR:	GE GE		GEBA	GERA
	 <p style="text-align: right;">LAT.</p> <p style="text-align: center;">GE-10D</p>	 <p style="text-align: right;">LAT.</p> <p style="text-align: center;">GE-11</p>	 <p style="text-align: right;">LAT.</p> <p style="text-align: center;">GEB-1D</p>	 <p style="text-align: right;">LAT.</p> <p style="text-align: center;">GEA-1</p>

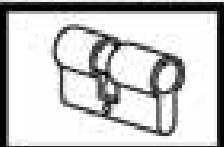
Copyright by
 Alejandro Altman S.A.
 2010
JMA

59

PARA-FOR:

GERA (D)

GERDA (PL)

GIBBONS (GB)

GIUSSANI (I)

PARA-FOR: **GERA**

GEA-2D GEA-3 GEA-4D GEA-5D

BOTO

PARA-FOR: **GERDA**

GDA-1.P GDA-3D GDA-30D GDA-50D

EUROPROFIL EUROPROFIL

PARA-FOR: **GERDA**

GDA-60D

EUROPROFIL

PARA-FOR: **GIBBONS**

GIB-1D

WILLENHALL

PARA-FOR: **GIUSSANI**

GIU-1 GIU-1D

GIU-2 GIU-2D

GIU-3D

SINCA GAL-LUME

Copyright by
Alpexco Alliance S.A.
2019

JMA

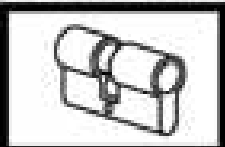

60

PARA-FOR: GIUSSANI

GLAZIEV

GLOBE

PARA-FOR:



GIU-4

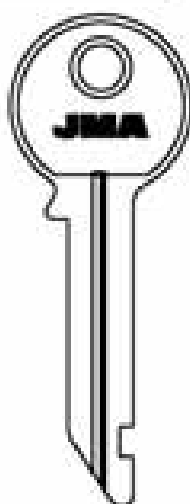

GLA-1D

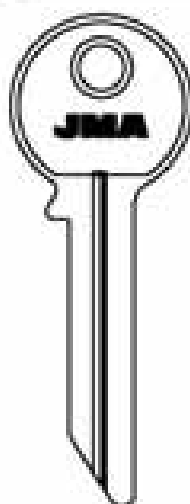

GLA-2D



GLO-11 GLO-1D



GIUSSANI (D)

GLAZIEV (RUS)

GLOBE (RC)

PARA-FOR: GLOBE

GLOBE

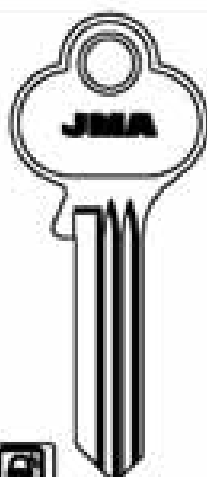

GLO-2 GLO-2D

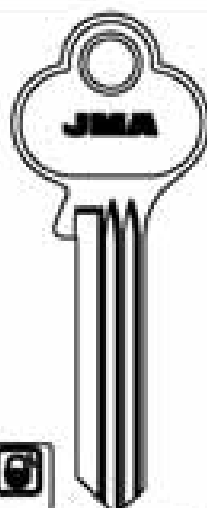

GLO-3 GLO-3D

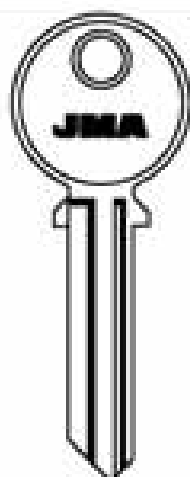

GLO-41 GLO-4D

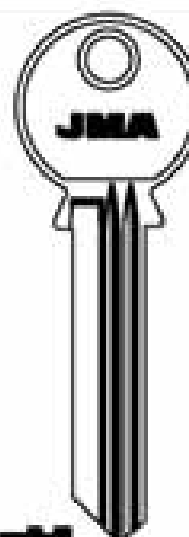

GLO-51

LASS

MIAN-FORCE

PARA-FOR: GLOBE

GLOBE

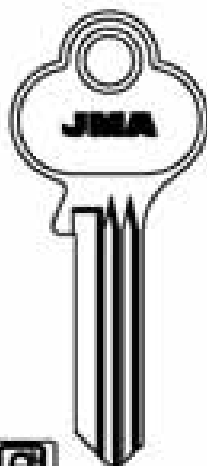

GLO-6 GLO-6D

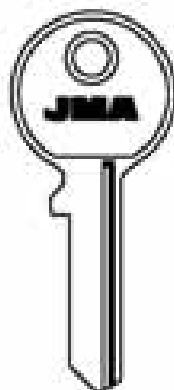

GLO-7 GLO-7D

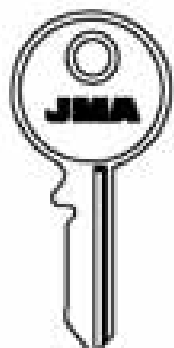

GLO-8 GLO-8D

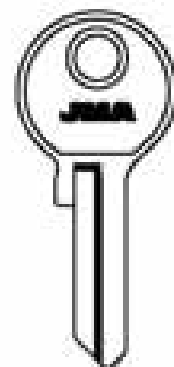

GLO-9D

COLD DOOR

Copyright by
Allegre Altes S.A.
2018

JMA

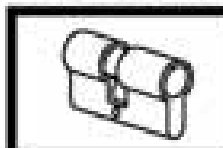

61

PARA-FOR:

- GLOBE (RC)**
- GR (RC)**
- GTV (D)**
- GUARD (HK)**
- GUERVILLE R. (F)**

PARA-FOR: **GLOBE**

GLO-10 GLO-11 GLO-120 GLO-22 GLO-220

GOLD DOOR

PARA-FOR: **GLOBE**

GLO-23 GLO-23D

ANLO-LUCO

PARA-FOR: **GR**

GRG-1

PARA-FOR: **GTV**

GTV-2 GTV-1D GTV-2D GTV-3D GTV-4D GTV-5D

TIEFENTHAL JEWEL-TIEFENTHAL

PARA-FOR: **GUARD**

GUA-1 GUA-1D GUA-2 GUA-2D GUA-3 GUA-3D

F&B

PARA-FOR: **GUERVILLE R.**

ALU. DEDEAUBAIN PT MONDIAL DE WINNER

GR-11 GR-1D GR-21 GR-2D GR-31 GR-3D

FERDIER

Copyright by
Alphonse Allouis S.A.
2018

JMA

62

PARA:
FOR:

GUERVILLE R.

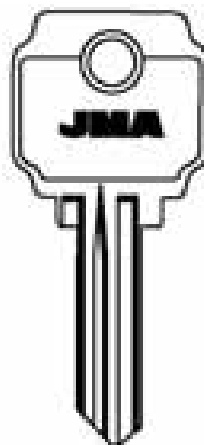
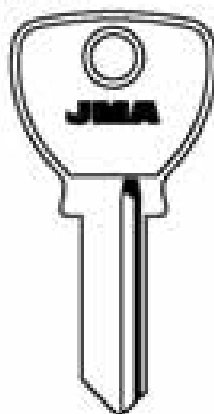
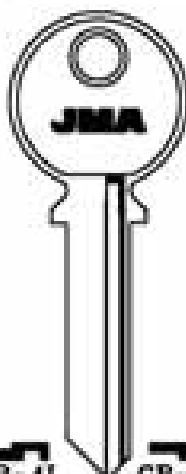

GR-41 GR-4D

GR-51 GR-5D

GR-6 GR-6D

GR-7 GR-7D

GR-8

MONDIAL

PARA-FOR:

**GUERVILLE R.
(F)**

HÄFELE (D)

HAGA (RC)

HARKOV (RUS)

HARLOC (USA)

PARA:
FOR:

HÄFELE

HAGA

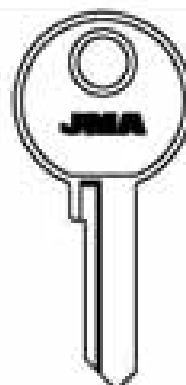
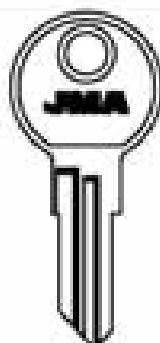
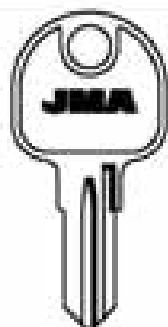

HAF-1 HAF-1D

HAF-4

HAF-2 HAF-2D

HAF-3D

HAG-1D

PARA:
FOR:

HARKOV

HARLOC

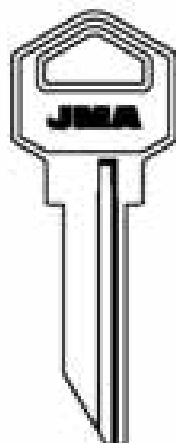
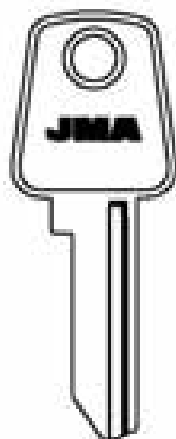
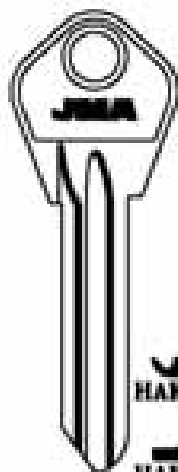

HAK-1D

HAK-2D

HAK-5

HAK-3

HAK-4

HAR-11

DWS-EAGLE-LORE

Copyright by
Alejandro Altamir S.A.
2013



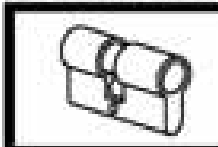

JMA





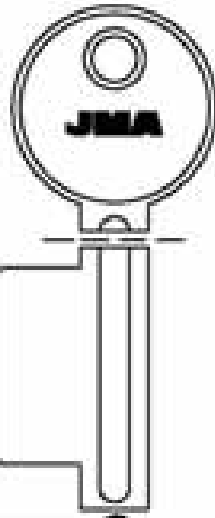
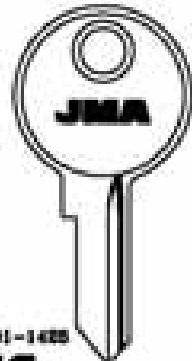

63

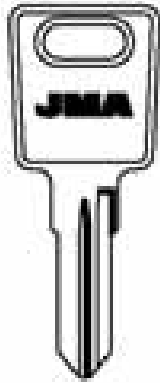
PARA-FOR:

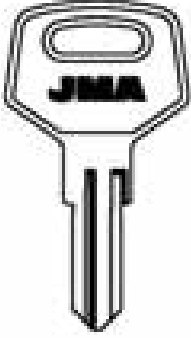
- HB (I)**
- HECTOR (E)**
- HEKNA (D)**
- HELIX (RC)**
- HENDERSON (USA)**
- HERME (RC)**
- HOBES (RCZ)**
- HORSE (RC)**

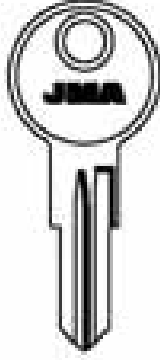
<p>PARA-FOR:</p> <p>HB</p>  <p>LEGALLARI</p>  <p>HB-1</p>	<p>HECTOR</p>  <p>HEC-1</p>	<p>HEKNA</p>  <p>HEK-1</p>  <p>HEK-2</p>  <p>HEK-3</p>  <p>HEK-4</p>
--	---	--

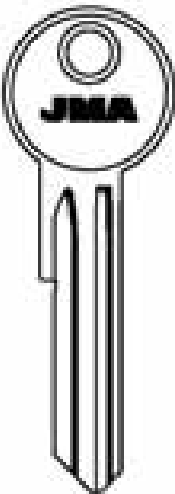
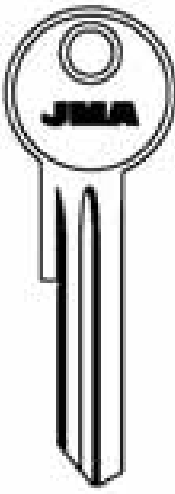
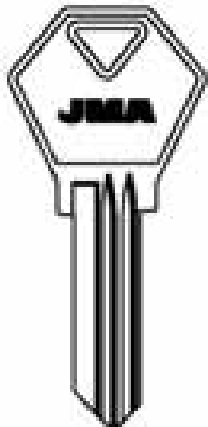
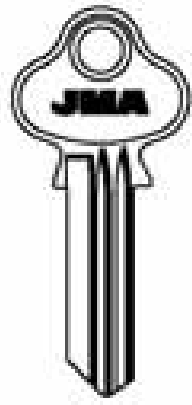
<p>PARA-FOR:</p> <p>HELIX</p>  <p>HEL-1</p>	<p>HENDERSON</p>  <p>HEN-1</p>  <p>HEN-1D</p>	<p>HERME</p>  <p>HRM-1</p>
--	---	---





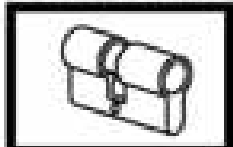

<p>PARA-FOR:</p> <p>HOBES</p>  <p>HOB-1</p>  <p>HOB-2D</p>	<p>HORSE</p>  <p>HOR-1</p>  <p>HOR-2</p>  <p>HOR-2D</p>
---	--

Copyright by
Algebra Alfas S.A.
1978

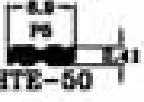
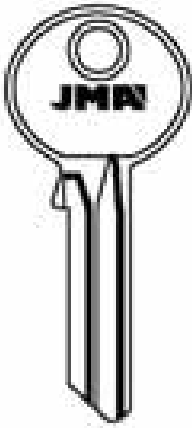
JMA



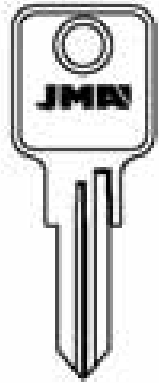









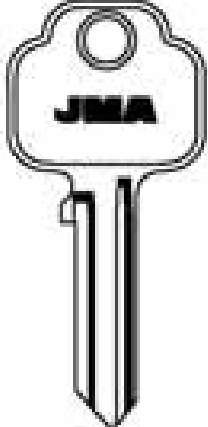

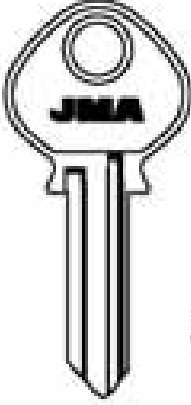
64

PARA-FOR: HTEC  LAT.  HTE-50 TWT	HTV   HT-1 VAUGHN	HUDSON   HUD-2D	HUWIL   HUW-1 HUW-1D STRAFOR-STRELCAR
---	---	--	---

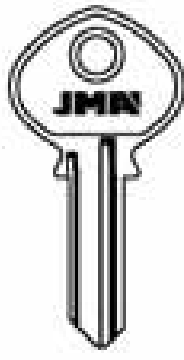
PARA-FOR:

- HTEC
- HTV (GB)
- HUDSON (USA)
- HUWIL (D)
- IBEAR (E)
- ICA (E)
- ICSA (D)
- IFAM (E)

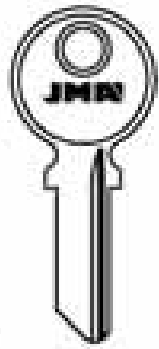
PARA-FOR: HUWIL   HUW-N TEND	IBEAR   IB-1 IB-2 ICA-SERIALLES	ICA  ALL.  ICA-1 ICA-4IP	
---	--	--	--

PARA-FOR: ICA   ICA-5IP	ICSA   ICS-1D ICS-2D ZANI		IFAM  LAT. ALL.  IF-11 JOMA
--	---	--	---

Copyright by
Allegretto Alfano S.A.
2008

JMA

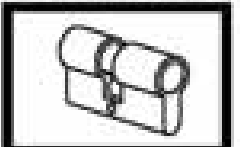







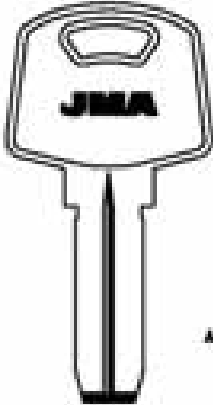

65

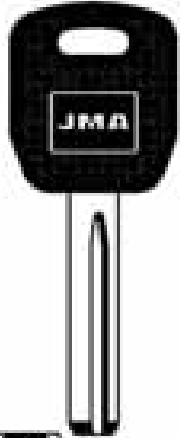

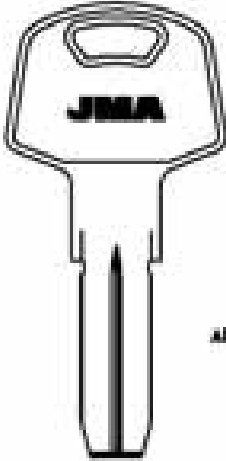

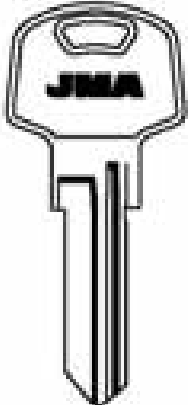





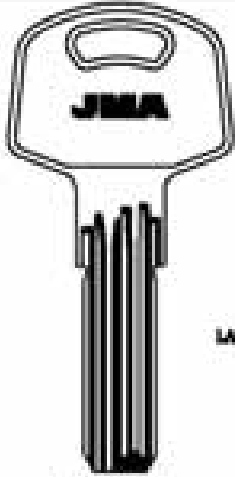







PARA-FOR:

IFAM (E)











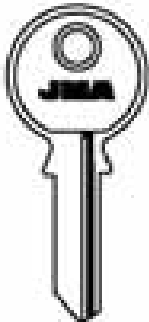







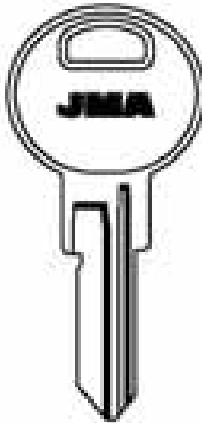

PARA-FOR: IFAM

 ALP.   IF-2	 ALP.   IF-3.P	 ALP.   IF-4	   IF-5
---	---	--	---

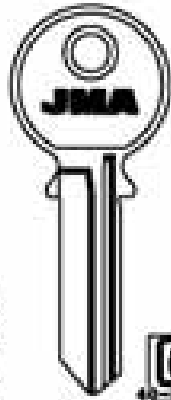
PARA-FOR: IFAM

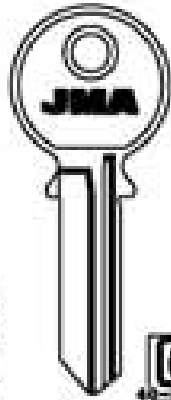
 LAT.   IF-6	   IF-15 TEM	   IF-120	   IF-D20	   IF-125	   IF-D25
		ABUS-JOMA-TEM-TELA		BATTU-FACC-JOMA GUARD-SIPA-TEM	



PARA-FOR: IFAM

   IF-130 JOMA	   IF-D30	 LAT. ALL.   IF-140	   IF-35	   IF-140L SIPA	 • ALL. • LAT. • PSH.   IF-150	   IF-45/55 150°  IF-151
---	---	---	--	--	---	--

Copyright by
 Alejandro Allina S.A.
 2019

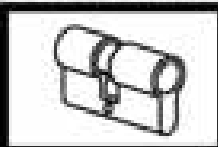
JMA

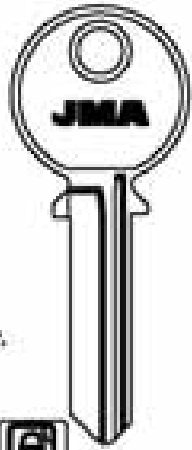

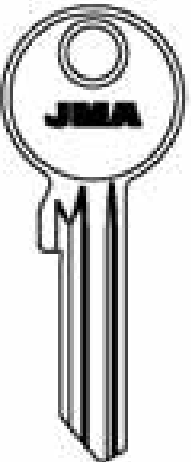
PARA-FOR: IFAM	IGS	IKON
 <p>JMA</p> <p>LAT.</p>  <p>IF-160/70 IF-60/70</p>	 <p>JMA</p> <p>IGS-1</p>	 <p>JMA</p> <p>SN4 ZE-1</p> <p>SN2 ZE-2</p> <p>NI ZE-6</p> <p>SN3 ZE-1D</p> <p>SN1 ZE-2D</p> <p>NI ZE-6D</p> <p>ZE-9D</p> <p>BRUNNE-OTIS</p>

PARA-FOR:

IFAM (E)

IGS (F)

IKON (D)

ILARGI (E)

ILCO (USA)

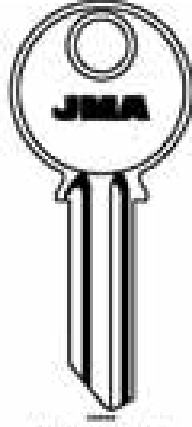
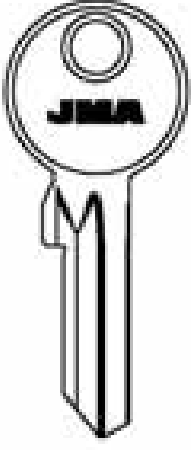
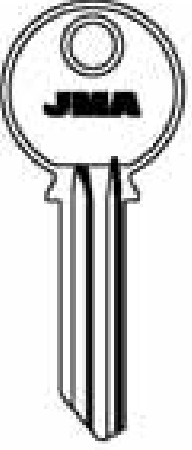
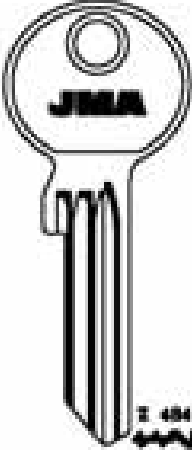
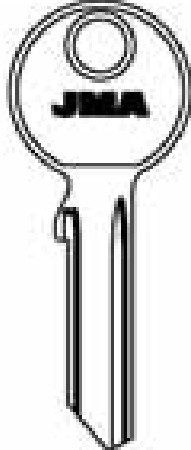
PARA-FOR: IKON				
 <p>JMA</p> <p>I A L D A L D A-B-C-D-E-F-G-H-I-L</p> <p>NI ZE-5I</p> <p>NI ZE-5D</p> <p>BRUNNE-OTIS</p>	 <p>JMA</p> <p>NI ZE-7D</p>	 <p>JMA</p> <p>NI ZE-8</p>	 <p>JMA</p> <p>I 484 ZE-100</p> <p>I 481 ZE-11D</p>	 <p>JMA</p> <p>NI ZE-13</p>

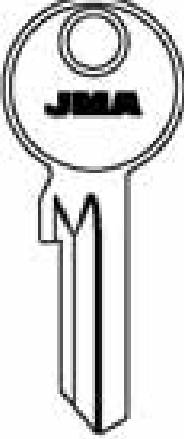
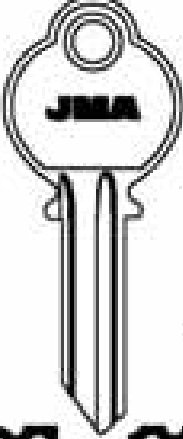
PARA-FOR: IKON	ILARGI	ILCO
 <p>JMA</p> <p>NI ZE-K2</p> <p>NI ZE-K1</p> <p>NI ZE-K0</p> <p>NI ZE-K5</p> <p>CORONA-FORT-SCHMITT</p>	 <p>JMA</p> <p>NI ZE-N1</p> <p>BURG</p>	 <p>JMA</p> <p>ALL.</p> <p>IL-11 IL-1D</p> <p>IL-2</p> <p>LAT.</p> <p>ILC-1D</p>

Copyright by
 Alejandro Altamir S.A.
 2010

JMA



67

PARA-FOR:

ILCO (USA)

ILLINOIS (USA)







IMB (KW)



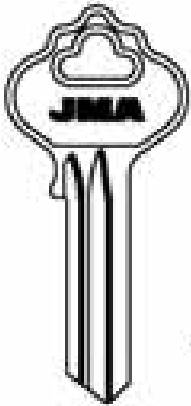
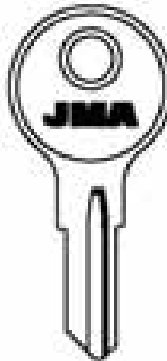
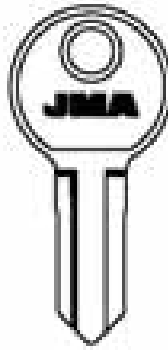
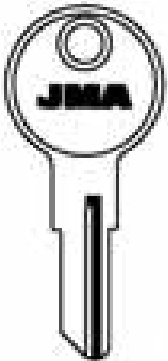



INCECA (E)



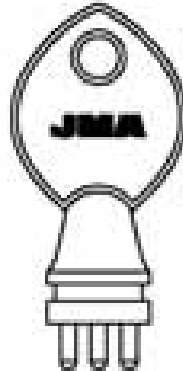
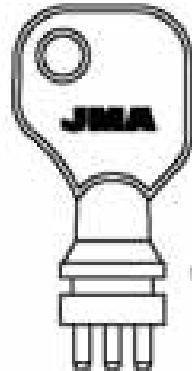

INGERSOLL (USA)

INT (D)

IR (F)

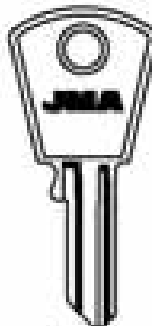
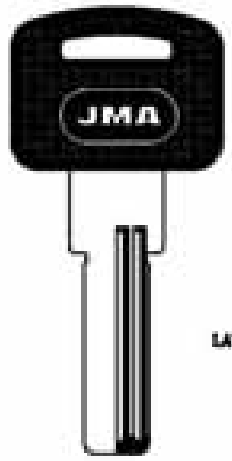
PARA-FOR:	ILCO	ILLINOIS			
	 LAT.	 LAT.	 LAT.	 LAT.	
	 ILC-2D	 ILC-3	 ILL-1 GRAYBILL-LAURANCE-OTIS BERNUNG	 ILL-2	 ILL-2D

PARA-FOR:	IMB	INCECA		INGERSOLL
	 LAT.	 LAT.	 LAT.	 LAT.
	 IMB-1	 INCE-1E	 INCE-2E	 ING-6

PARA-FOR:	INGERSOLL	INT	IR
	 LAT.	 LAT.	 LAT.
	 ING-A	 INT-1	 IR-1.P BYT-IPAM

Copyright by
Alpex S.p.A. S.A.
1978

JMA

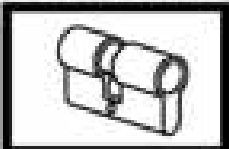

68

PARA:
FOR:

ISEO

PARA-FOR:

ISEO (I)

ITO (TR)

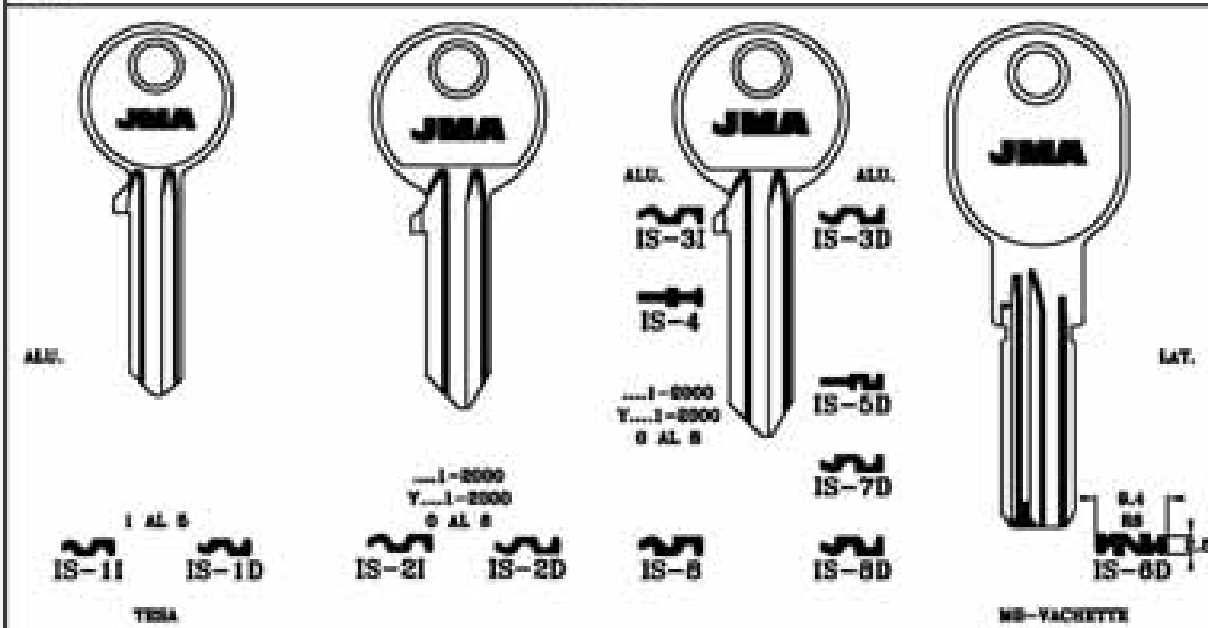

PARA:
FOR:

ISEO

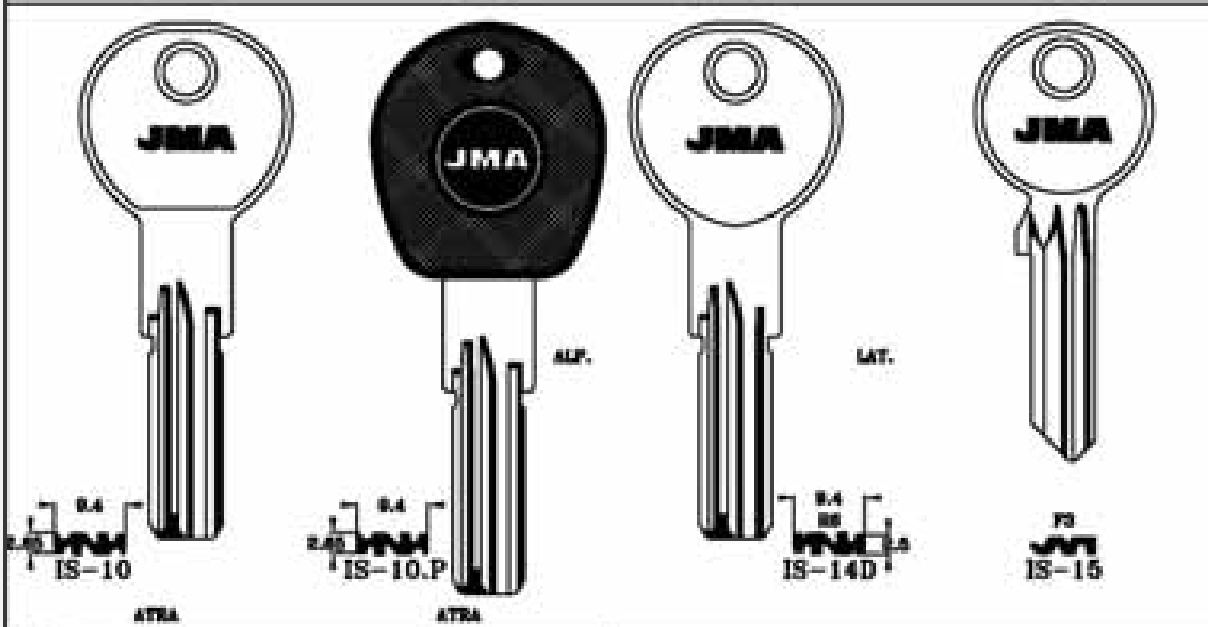

PARA:
FOR:

ISEO

ITO

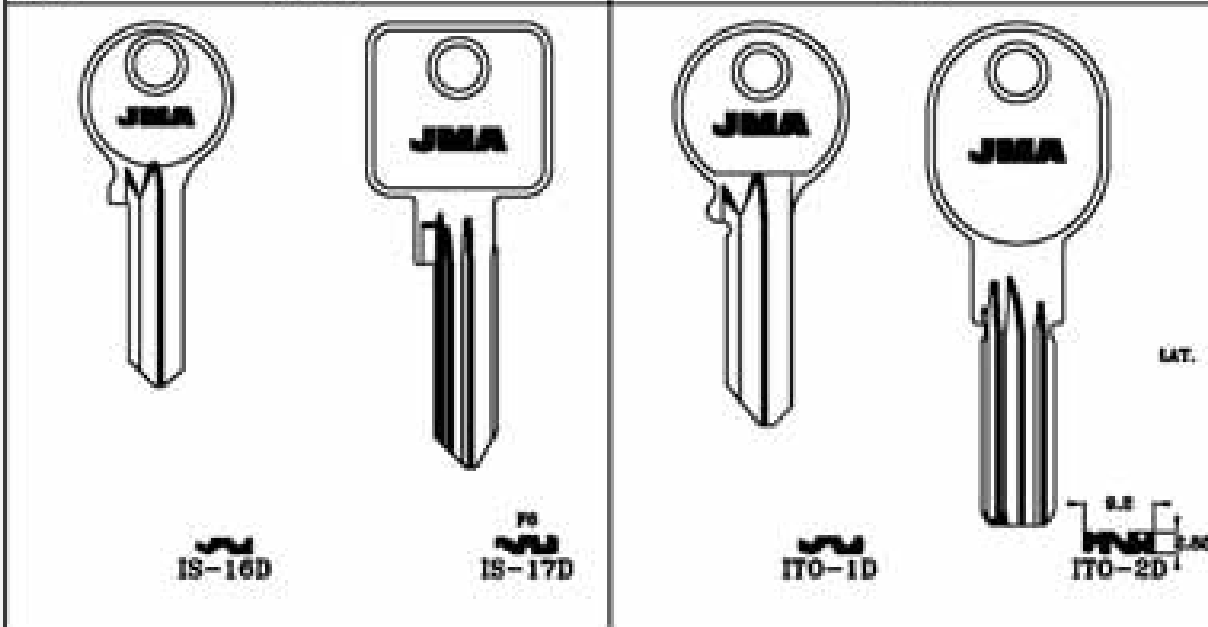

Copyright by
Alejandro Altman S.A.
2018

JMA

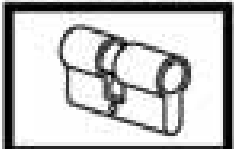

69

PARA-FOR:









IVANA (D)

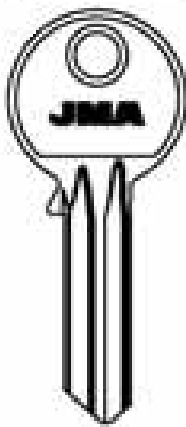

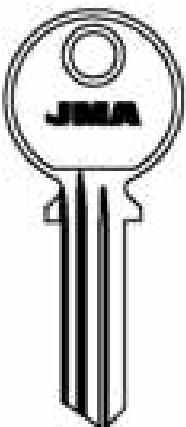

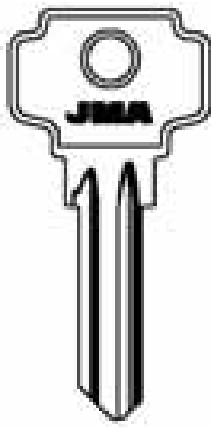

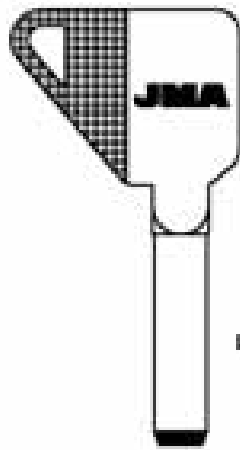

JARDI (E)

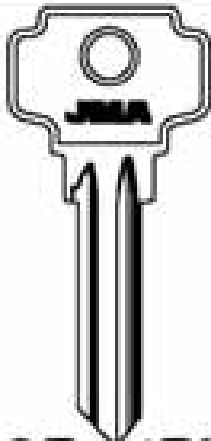

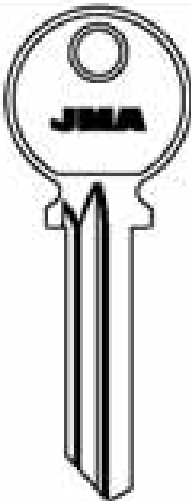

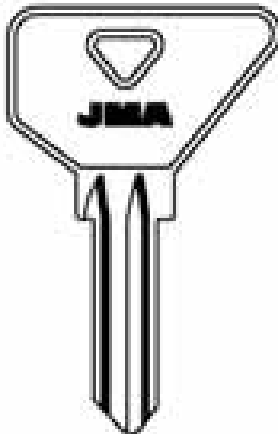

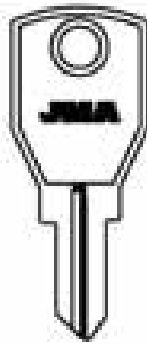

JINLONG (RC)

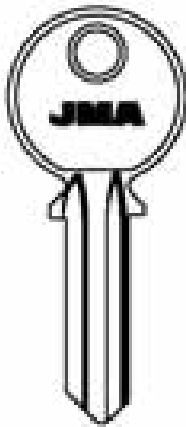
JIP (E)

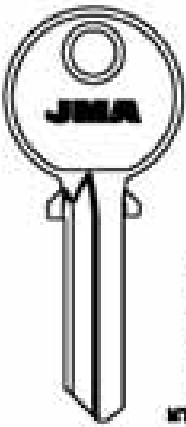
JIS (E)

PARA-FOR:	IVANA	JARDI		
	  IV-1	  IV-2D	  JAR-11 JAR-1D JAR-3	  LAT. C JAR-1E

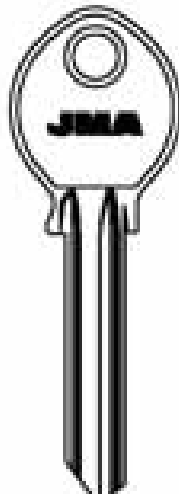
PARA-FOR:	JARDI		JINLONG	
	  JAR-21 JAR-2D JAR-8 JAR-8D	  JAR-4D	  JAR-51 JAR-5D	  JIN-1D



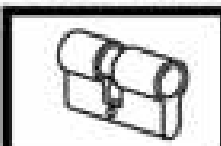

PARA-FOR:	JIP	JIS		
	  JIP-11 JIP-1D	  JIS-1D	  JIS-21 SEMEL	  JIS-31 JIS-3D

Copyright by
Algodora Alfas S.A.
2018



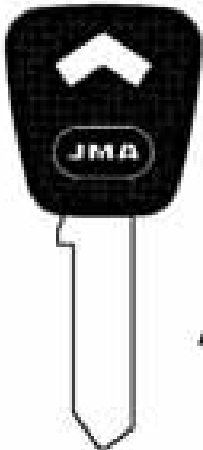

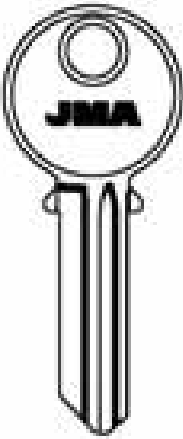
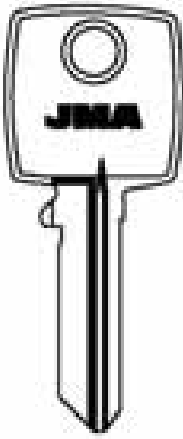
JMA





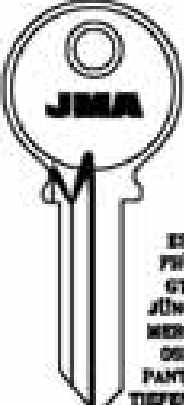
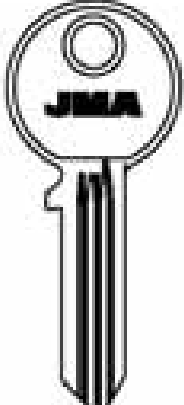

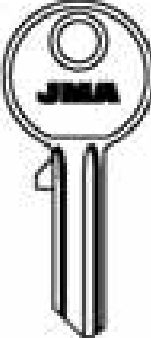

70

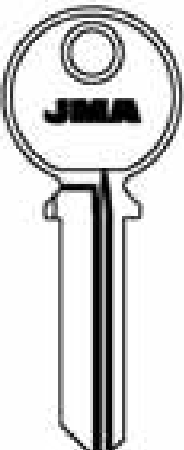
PARA-FOR: JIS	JOMA	JOVI	JOWIL
 M.P.	  JOM-1D	 JO-1	 JWL-1D
 JIS-4.P			

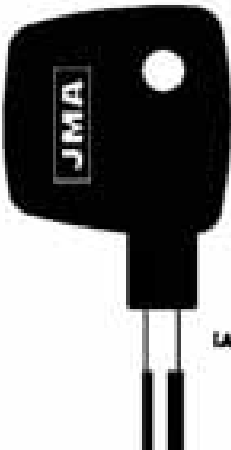
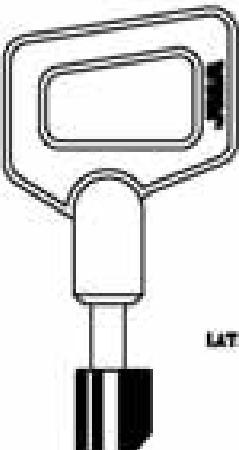
PARA-FOR:
JIS (E)
JOMA (E)
JOVI (E)
JOWIL (D)
JPM (F)

PARA-FOR:	JOWIL		
 ESE PULCR STY JUNCOY MERCUR OSKO PANTHER TIPENTAL TRITON YORO VEPA	 JWL-4D	 JWL-5	 JWL-6
 JWL-2D	 JWL-3D		

PARA-FOR: JOWIL	JPM		
 JWL-7D	 JPM-1I JPM-2I JPM-4	 LAT. JPM-1E	 LAT. JPM-2E
	 JPM-1D  JPM-2D  JPM-4D JPM		

Copyright by
 Alejandro Alonso S.A.
 2010

JMA

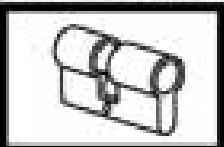

71

PARA-FOR:

JPM (F)

JTF (F)



JU JUNGINGER (D)







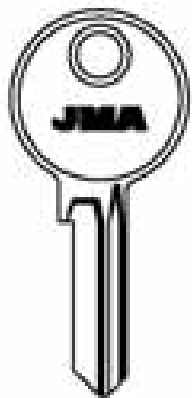
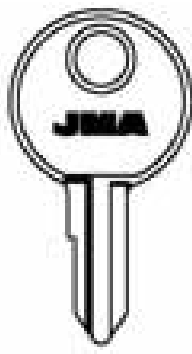

JUNGHEINRICH (D)





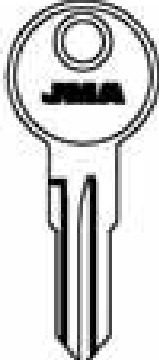
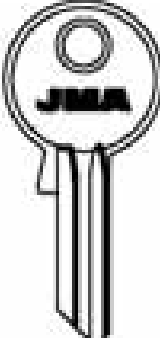

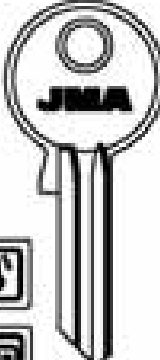
JUNIE (D)

JUNKUNG (USA)

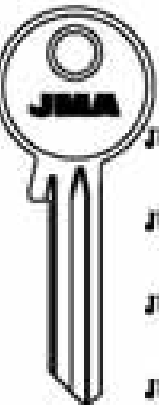
JUZU (E)

	<p>PARA-FOR: JPM</p>  <p style="text-align: center;">JPM-3D</p>	<p>PARA-FOR: JTF</p>  <p style="text-align: center;">JTF-11</p>  <p style="text-align: center;">JTF-21</p> <p style="text-align: center;">JTF-3</p>  <p style="text-align: center;">JTF-4</p>		
--	--	--	--	--

<p>PARA-FOR: JU JUNGINGER</p>	<p>JUNGHEINRICH</p>  <p style="text-align: center;">JNG-1</p>  <p style="text-align: center;">JNG-1D</p>  <p style="text-align: center;">JNG-2D</p>  <p style="text-align: center;">JNG-3</p>	<p>JUNIE</p>  <p style="text-align: center;">JGH-1D</p>  <p style="text-align: center;">JUNI-1</p>  <p style="text-align: center;">JUNI-1D</p> <p style="text-align: center;"><small>PERSONALS-US</small></p>	<p>JUNIE</p>  <p style="text-align: center;">JUNI-2</p>  <p style="text-align: center;">JUNI-2D</p>  <p style="text-align: center;">JUNI-3D</p> <p style="text-align: center;"><small>PERSONALS-US</small></p>
--------------------------------------	---	---	--

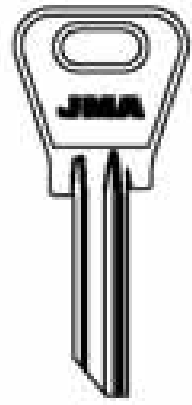
<p>PARA-FOR: JUNIE</p>	<p>JUNKUNC</p>  <p style="text-align: center;">JU-1</p> <p style="text-align: center;"><small>A.MOTORS-BUILT-LION</small></p>	<p>JUNIE</p>  <p style="text-align: center;">JUNI-3D</p>  <p style="text-align: center;">JUNI-4D</p>  <p style="text-align: center;">JUNI-5D</p>  <p style="text-align: center;">JUNI-6D</p>  <p style="text-align: center;">JUNI-7D</p>  <p style="text-align: center;">JUNI-8D</p> <p style="text-align: center;"><small>A.MOTORS-BUILT-LION</small></p>	<p>JUZU</p>  <p style="text-align: center;">JUZU-1</p> <p style="text-align: center;"><small>ALSO-A.MOTORS-BUILT-LION</small></p>
-------------------------------	--	---	--

Copyright by
Allegretto Allione S.A.
1978

JMA

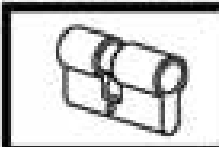

PARA:
FOR:

JVAL

KABA

PARA-FOR:

JVAL (P)

KABA (CH)

KALE (TR)

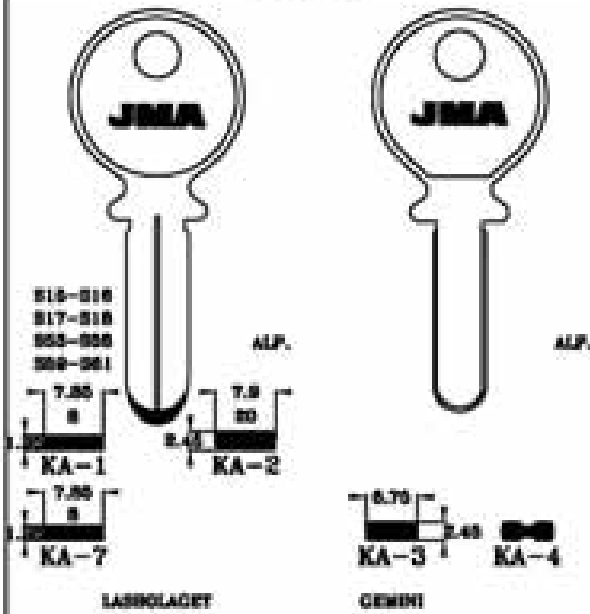
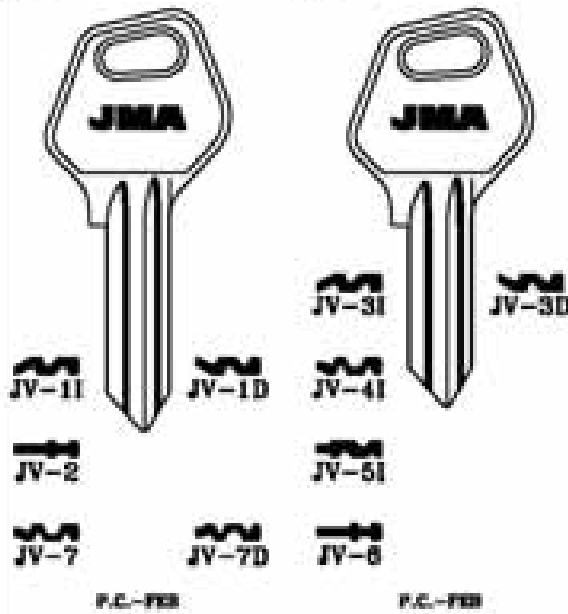

PARA:
FOR:

KABA

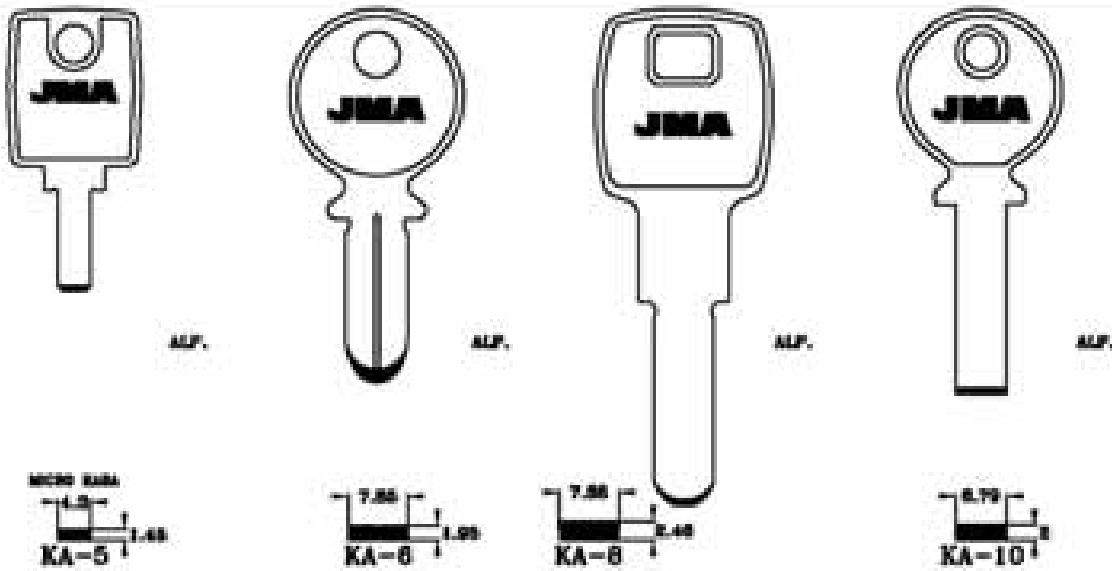

PARA:
FOR:

KABA

KALE

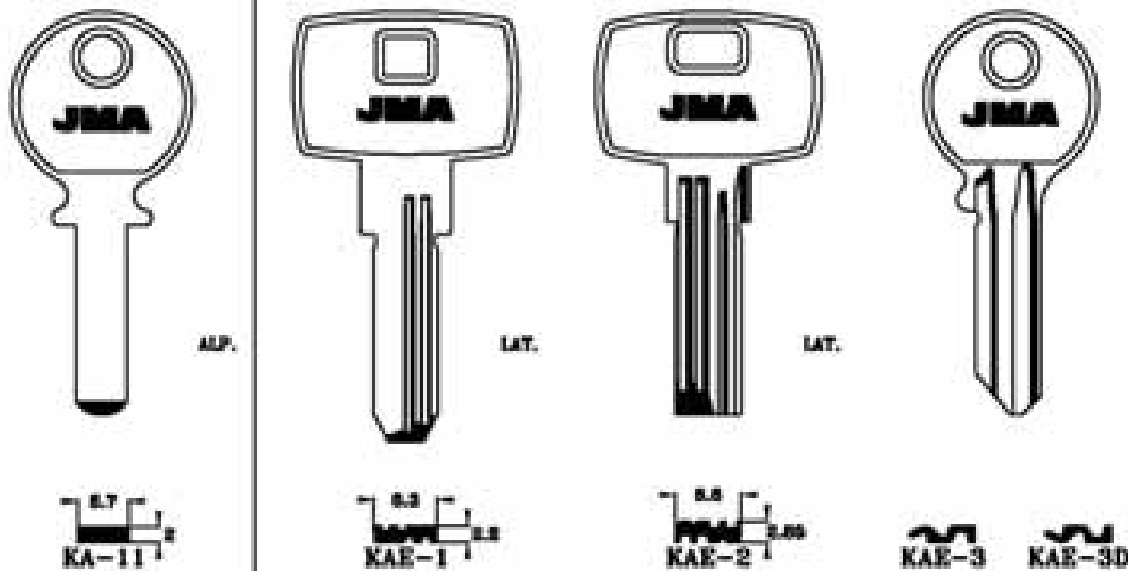

Copyright by
Alejandro Alfaro S.A.
2010



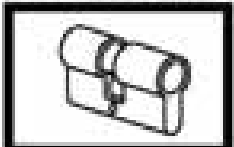





JMA

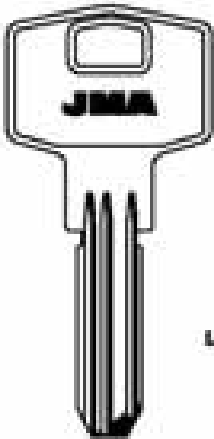

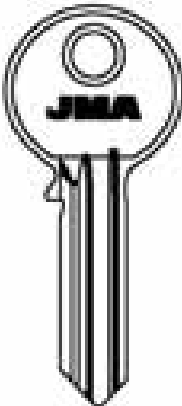
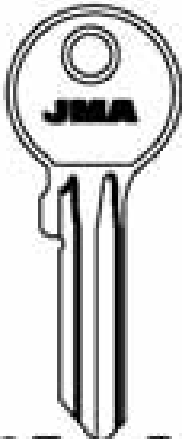
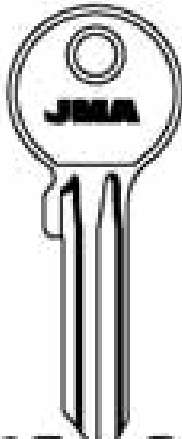





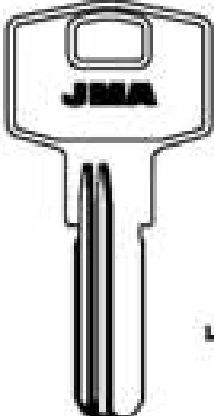

73

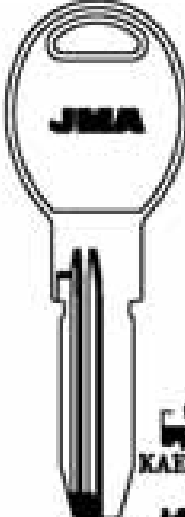
PARA-FOR:

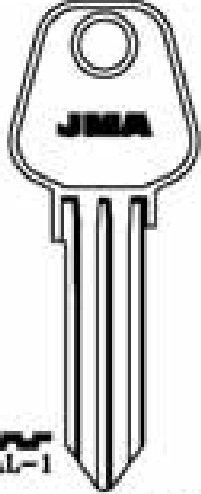
- KALE (TR)**
- KALUGA (RUS)**
- KAP (RUS)**
- KAZAN (RUS)**

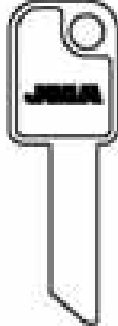
<p>PARA-FOR:</p>	KALE								
 <p style="text-align: center;">LAT.</p>  <p style="text-align: center;">KAE-4</p>	 <p style="text-align: center;">KAE-5</p>	 <p style="text-align: center;">KAE-6</p>	 <p style="text-align: center;">KAE-6D</p>	 <p style="text-align: center;">KAE-7</p>	 <p style="text-align: center;">KAE-7D</p>	 <p style="text-align: center;">KAE-8</p>	 <p style="text-align: center;">KAE-8D</p>	 <p style="text-align: center;">KAE-9</p>	 <p style="text-align: center;">KAE-9D</p>

<p>PARA-FOR:</p>	KALE	KALUGA	KAP
 <p style="text-align: center;">LAT.</p>  <p style="text-align: center;">KAE-10D</p>	 <p style="text-align: center;">LAT.</p>  <p style="text-align: center;">KAE-11D</p>  <p style="text-align: center;">KAE-12D</p>	 <p style="text-align: center;">KAL-1</p>  <p style="text-align: center;">KAL-2D</p>	 <p style="text-align: center;">LAT.</p>  <p style="text-align: center;">KAP-1D</p>  <p style="text-align: center;">KAP-2D</p>

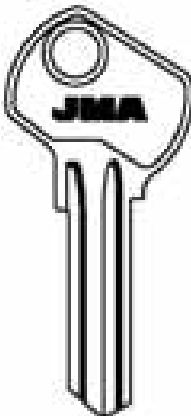
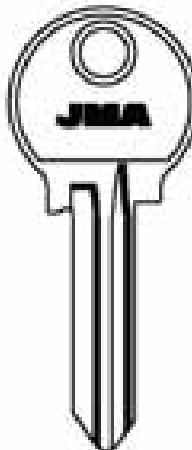
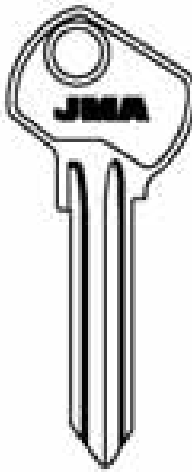
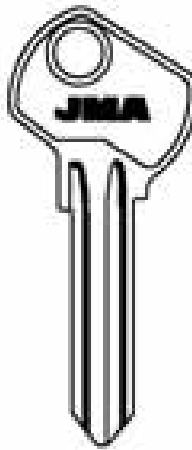









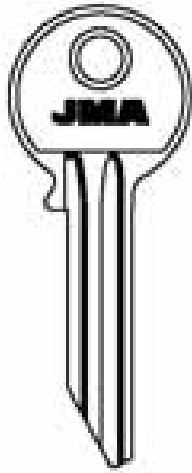

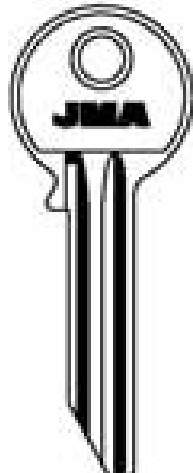

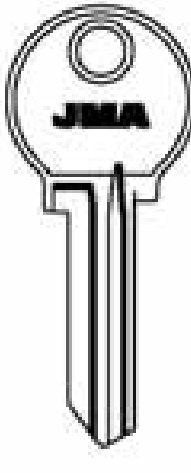

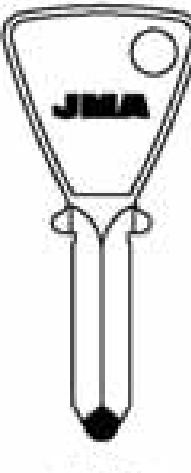

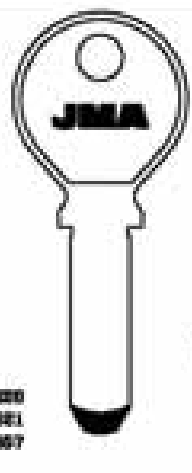
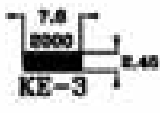
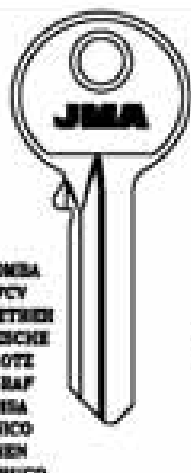
<p>PARA-FOR:</p>	KAZAN			
 <p style="text-align: center;">KAZ-1</p>	 <p style="text-align: center;">KN KAZ-2</p>	 <p style="text-align: center;">KAZ-3</p>	 <p style="text-align: center;">KAZ-4</p>	

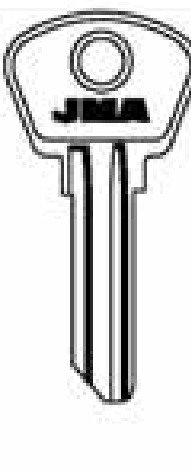
Copyright by
Alpacor Alfasa S.A.
2019

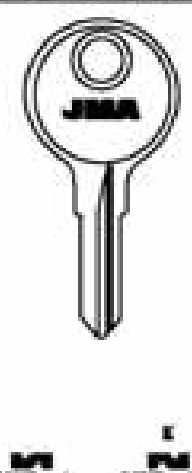

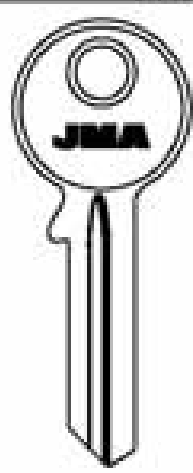
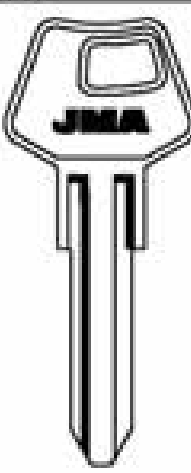
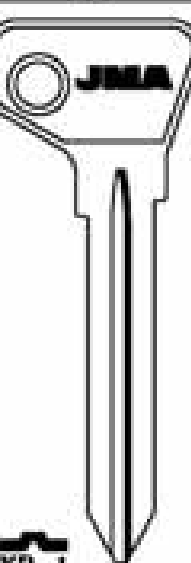

74

<p>PARA: FOR:</p>	<p>KAZAN</p>      		<p>KESO</p>   <p>ALP.</p>	<p>PARA-FOR:</p> <p>KAZAN (RUS)</p> <p>KESO (CH)</p> <p>KFV (D)</p> <p>KICHINEV (RUS)</p> <p>KIFERM (F)</p> <p>KIROVMACH (RUS)</p> <p>KP (RUS)</p>
<p>PARA: FOR:</p>	<p>KESO</p>   <p>ALP.</p>	<p>KFV</p>  <p>CONDA FCV FLUETTER GIESCHER GOTE GRAP HSA NICO SEN SCHUCO</p> 	<p>KICHINEV</p>  	
<p>PARA: FOR:</p>	<p>KIROVMACH</p>     		<p>KP</p>  	<p>Copyright by Allegretto Altman S.A. 2010</p>   <p>75</p>

PARA-FOR:

KRAMATORSK (RUS)







KREMENCHUG (RUS)



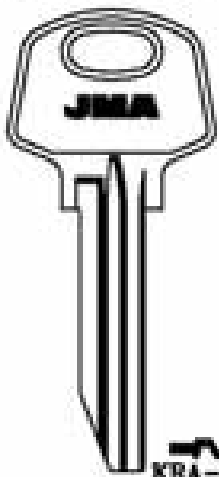

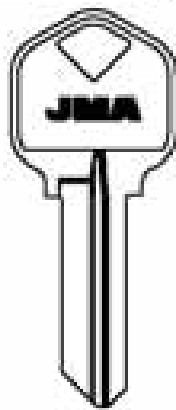
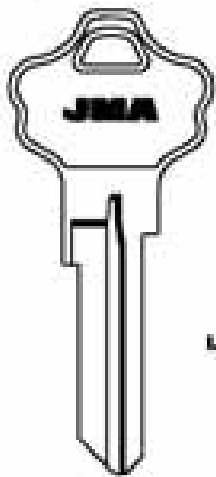
KWIKSET (USA)





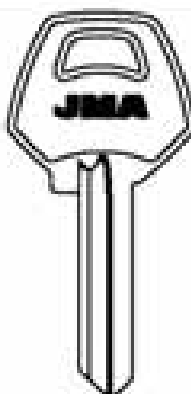
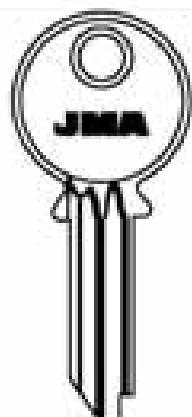
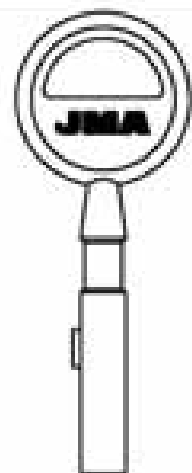

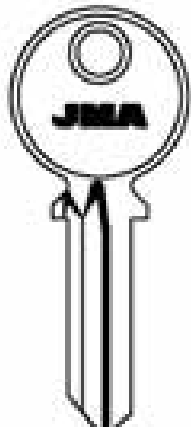
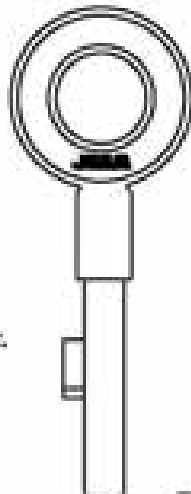

KYNNARPS (GB)

LAFONTE (BR)

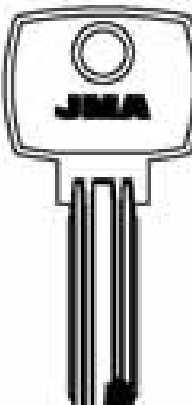
LAPERCHE (F)

	PARA-FOR: KRAMATORSK	KREMENCHUG	KWIKSET	
	 KRA-1D	 KRE-1D	 1 AL 7 KWI-1	 LAT. KWI-2D TITAN
	 KRA-2	 KRE-1D	 KWI-1	 KWI-2D
			DISCARD - EJECT - FACIETTE	

PARA-FOR:	KYNNARPS	LAFONTE	LAPERCHE	
	 KNA-1D	 LAF-1D	 DM LAP-1	 LAT. LAP-1E
	 KNA-1D	 LAF-1D	 LAP-1	 LAP-1E

PARA-FOR:	LAPERCHE			
	 LAT. LAP-2D	 LAT. LAP-2E	 LAT. LAP-3I	 LAT. LAP-3D
	 LAP-2D	 LAP-2E	 LAP-3I	 LAP-3D
			 LAP-4	
			GENN-80818	

Copyright by
Algebris Alfas S.A.
2018

JMA

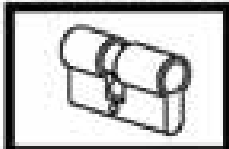

76

PARA:
FOR:

LAPERCHE



LAP-5D

CEMN-BONIS



ALP.
 LAP-8D

LAP-11D

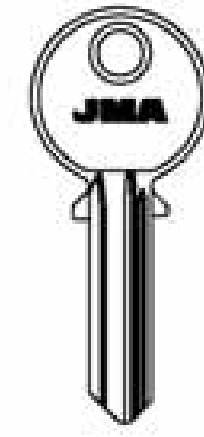

LAP-9

LAP-9D



ALP.
 LAP-10D

PARA-FOR:

LAPERCHE (F)

PARA:
FOR:

LAPERCHE

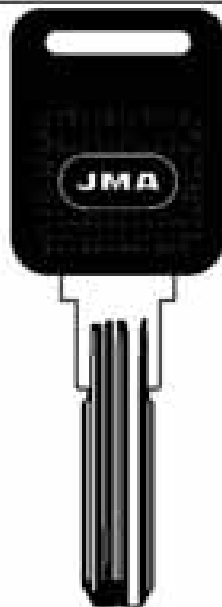

LAP-13.P

LAP-17.P

LAP-20.P

LAP-21.P

LAP-22.P

LAP-23.P

ALP.



LAP-28D

LAP
 LAP-29D

LAP
 LAP-30D

LAP
 LAP-34D

CEMN-BONIS

PARA:
FOR:

LAPERCHE

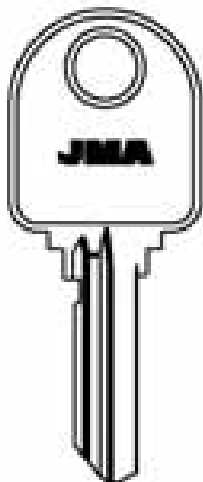

LAP-42D

LAP-43D

LAP-44D

LAP-45D

LAP-46D

CEMN-BONIS

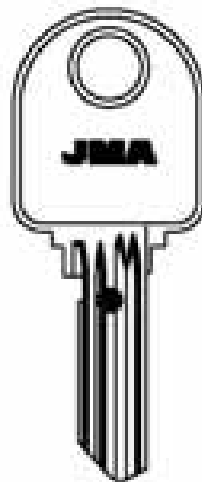

BSC
 LAP-88

FICHET

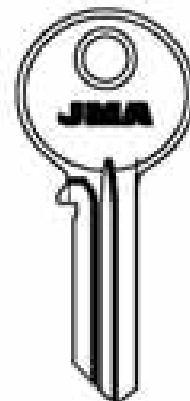

LAP-96D

VACHETTE

Copyright by
Alejandro Allier S.A.
2010

JMA

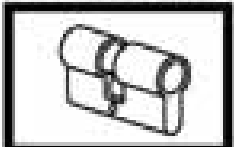

77

PARA:
FOR:

LAS

LÅSBOLAGET

PARA-FOR:

LAS (F)

LÅSBOLAGET
(S)

LEGG (GB)

LINCE (E)

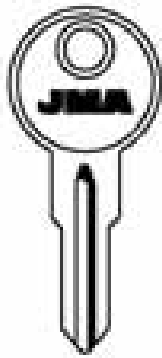

AX
001-024
LAS-AX/L



R
001-024
LAS-R

Y
001-024
LAS-Y

Y
001-024
LAS-Y

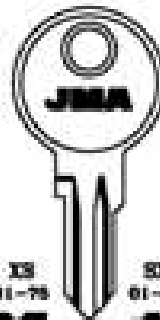

XS
01-79
LAS-XS

SX
01-79
LAS-SX

TX
01-79
LAS-TX

XY
01-79
LAS-XY

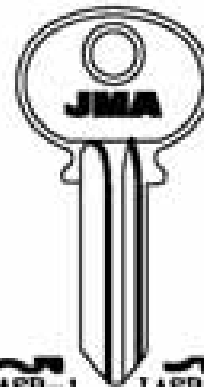

LASB-1

LASB-1D

LASB-2

LASB-2D

LASB-3D

ATLAL-BAEPELE-KIPEEM-ROKZ

DUBOIS-KIPEEM-FI-PK

ATLAL-FU-KIPEEM-METSEK-ROKZ

TANLOCKER

PARA:
FOR:

LEGG

LINCE

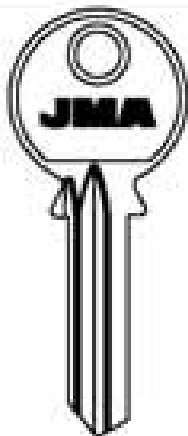

I AL 7
LEG-1D

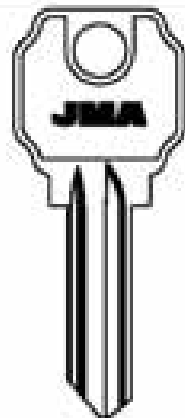

A
LIN-11

A
LIN-1D



B
LIN-2

C
LIN-3I

B
LIN-15I

NO COL
LIN-15D

** FEB.
** MTC (L)
* LAT.
* ADD.
* COL.



LIN-4

LIN-14

LIN-4I

LIN-4D

LIN-14I

LIN-14D

LIN-20D

PARA:
FOR:

LINCE

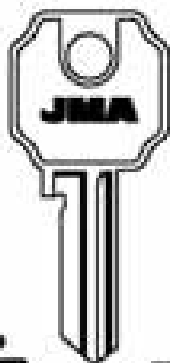

LAT.
ADD.

D
LIN-5I

D
LIN-5D

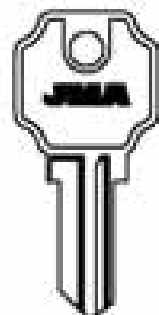

T
LIN-12I

T
LIN-12D

F
LIN-6I

F
LIN-6D



B1
LIN-18

B1
LIN-18D

F
LIN-17

F
LIN-17D



F
LIN-71

F
LIN-7D

J
LIN-8I

J
LIN-8D

Copyright by
Allegre Altesa S.A.
2010

JMA

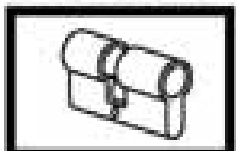

79

PARA-FOR:

LINCE (E)

LIPS (NL)

PARA-FOR: **LINCE**

LIN-9
 LIN-101
 LIN-100
 LIN-100
 LIN-111
 LIN-110
 LIN-13

ALP.

PARA-FOR: **LINCE**

LIN-190
 LIN-210
 CRAIN-105A-018

PARA-FOR: **LIPS**

LIP-11
 LIP-10
 LIP-16D

PARA-FOR: **LIPS**

LIP-2
 LIP-2D
 LIP-3
 LIP-4
 LIP-33
 LIP-28D

Copyright by
Alpacare Alltime S.A.
1978

JMA



80

PARA:
FOR:

LITTO

PARA-FOR:

LITTO (B)

LOB (PL)

LOCK (MEX)

LOCKWOOD
(AUS)

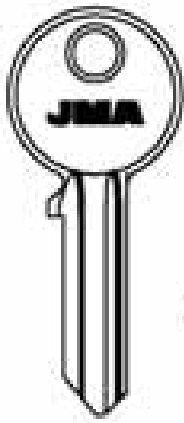

ALL
WTC.

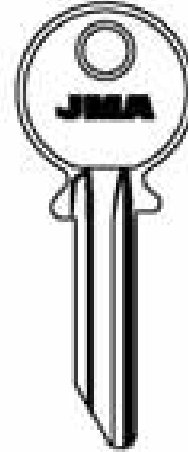
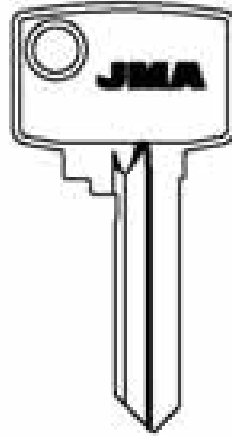
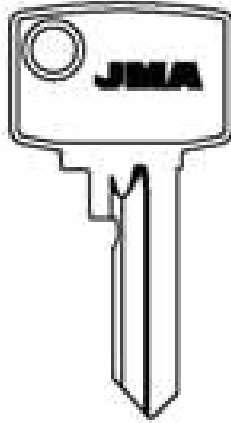

LIT-11

ANDEKLOT



LIT-20



LIT-30



LIT-51



LIT-50

EEI

PARA:
FOR:

LITTO

LOB

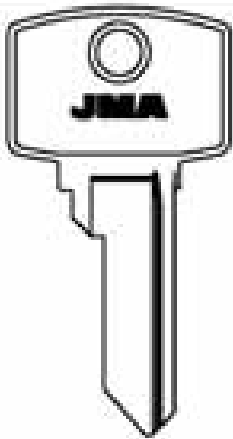

LIT-70



LB-1



LB-1D

EXPRES

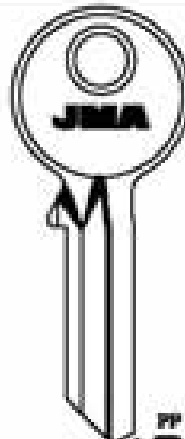

LB-2D



LB-4D

ENCARD-EXPRES-BEDY-YETI

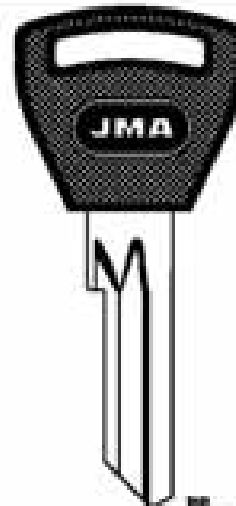

LB-2D.P

ENCARD-EXPRES-BEDY-YETI

PARA:
FOR:

LOB

LOCK

LOCKWOOD

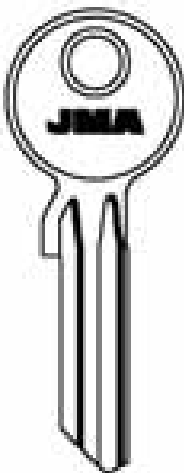

LB-3



LB-3D

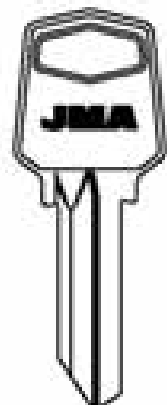

ACE
LAT.



LOC-1D

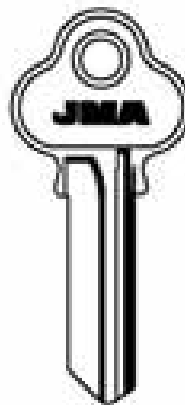

LWO-1



LWO-1D

CATHERBOUC

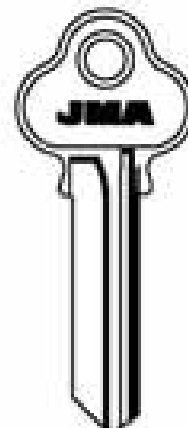

LWO-2



LWO-2D

Copyright by
Aljeandro Almon S.A.
2010

JMA

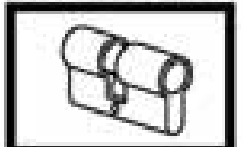





81

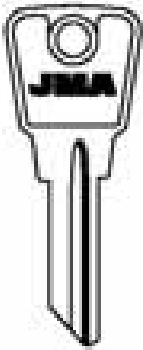

PARA-FOR:

**LOCKWOOD
(AUS)**

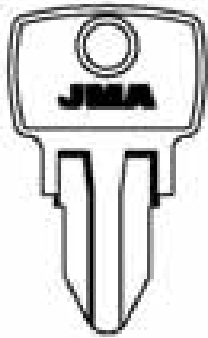
LOGO (I)

L. & F. (GB)

<p>PARA-FOR:</p> <p>LOCKWOOD</p>  <p>844 LWO-7D</p>	<p>PARA-FOR:</p> <p>LOCKWOOD</p>  <p>CL. 1-1000 LWO-8</p>	<p>PARA-FOR:</p> <p>LOCKWOOD</p>  <p>H LWO-9 LEN-LOK</p>	<p>PARA-FOR:</p> <p>LOGO</p>  <p>ALL</p> <p>LO-11 LO-1D LO-3D CISA</p>
--	--	--	--

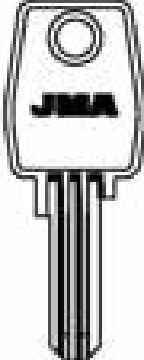
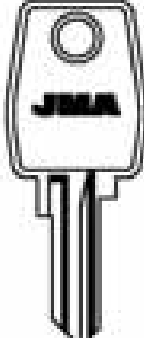
<p>PARA-FOR:</p> <p>LOGO</p>  <p>LO-21 LO-2D LO-4D CISA</p>	<p>PARA-FOR:</p> <p>LOWE & FLETCHER</p>  <p>IF 1000</p> <p>91...1-200 ...1-400 91...201-270 91...1-4000 91...1-400 91...270-300</p> <p>LF-11 LF-1D CEN-EURO LOCKS-UNION</p>  <p>95001-97000 97001-99000</p> <p>LF-2 LF-12 LF-12D MIDDLE CYCLE DOUBLE SAFE-EURO LOCKS</p>  <p>LF-41 EURO LOCKS</p>		
--	--	--	--

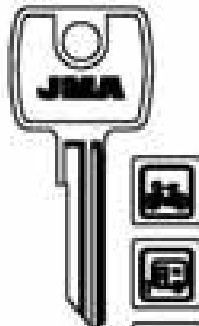
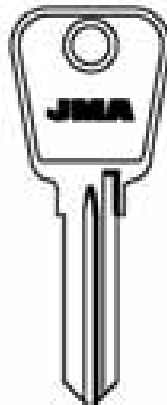
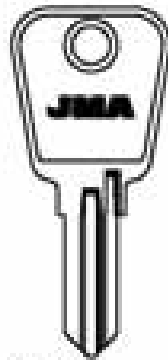
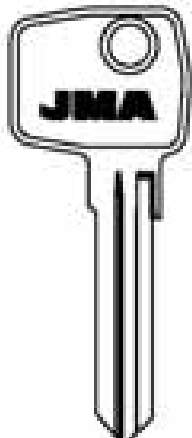
<p>PARA-FOR:</p> <p>LOWE & FLETCHER</p>  <p>70001-71000 N... 70001-71000</p> <p>LF-5 LF-5D LF-32 TELFORD</p>	<p>PARA-FOR:</p> <p>LOWE & FLETCHER</p>  <p>60001-67000 61001-67000</p> <p>LF-7 LF-7D PURE EUROPE</p>	<p>PARA-FOR:</p> <p>LOWE & FLETCHER</p>  <p>91...201-400 ...93001-94000</p> <p>LF-8 LF-8D 91...401-900 ...90501-90975</p> <p>LF-11 LF-11D EURO LOCKS-MISSA-LTE</p>	<p>PARA-FOR:</p> <p>LOWE & FLETCHER</p>  <p>LF-10 EURO LOCKS</p>
--	--	--	---

Copyright by
Alpandre Altina S.A.
1978

JMA

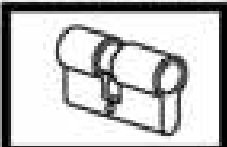

PARA:
FOR:

LOWE & FLETCHER

PARA-FOR:

L. & F. (GB)

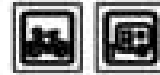
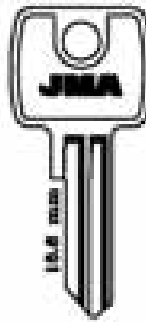
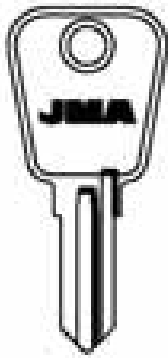

ES... 001-400
ES... 001-200
ES... 001-200
...1-400
CEK...1-100
M...1-400
BY...1-400
BYV...1-400
SP...1-400
SE...1-400

LF-15
LFE
001-100
LF-17

ES... 001-400
... 0001-04000

LF-13 LF-13D

WIKKA-UTS

LF-14D

EURO LOCKS

CEK-EURO LOCKS-ULTRA-UNION

PARA:
FOR:

LOWE & FLETCHER

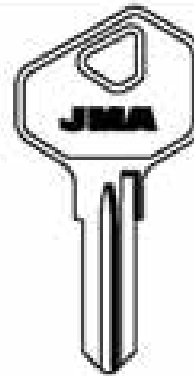
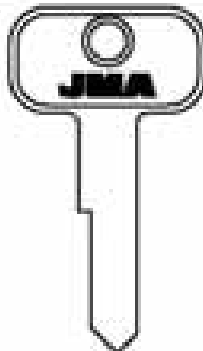
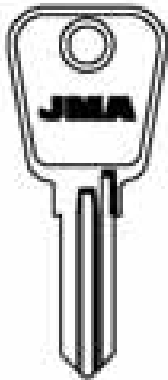

ES... 1-400
...17001-18000
... 7001-8000

LF-16

LF-18D

LF-19

LF-20 LF-20D

PARA:
FOR:

LOWE & FLETCHER

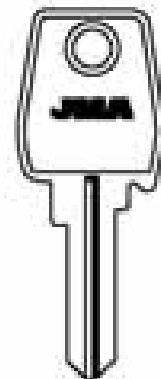
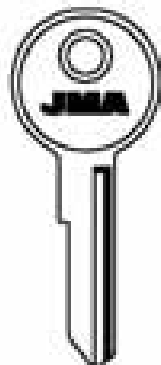
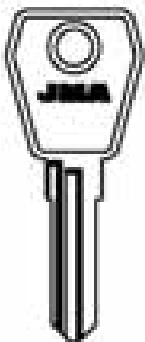

...5000-50400
...70000-70000
...70000-70000

LF-21

LF-33D

LF-22

LF-23

LF-24

ULTRA

DOUBLE SAFE-EURO LOCKS

Copyright by
Aljeandro Almon S.A.
2010

JMA

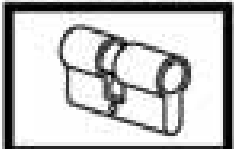

83

PARA-FOR:

L. & F. (GB)

PARA-FOR:

LOWE & FLETCHER

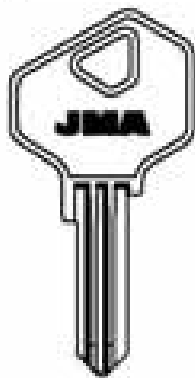

V...1-48
 LF-25
 14001-14006
 LF-40

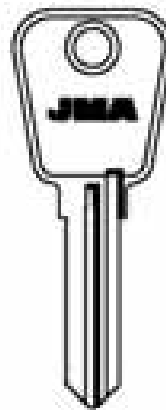

LF-26



LF-27
 EURO LOCKS

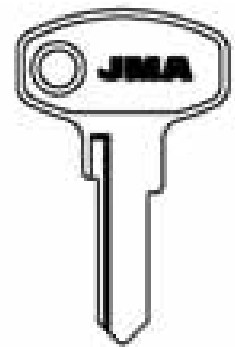

LF-28
 EURO LOCKS

PARA-FOR:

LOWE & FLETCHER



95...401-900
 ...90001-90075
 LF-29D
 EURO LOCKS



08...1-900
 08...1-478
 LF-30



LF-31



LF-34

PARA-FOR:

LOWE & FLETCHER



R...001-000
 ...0001-0404
 LF-35

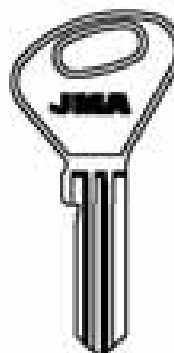

LF-36



LF-37D

LF-38D

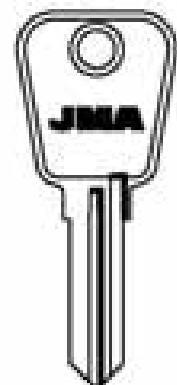

LF-41

Copyright by
 Alpacas Alfas S.A.
 1978

JMA



PARA:
FOR:

LUCKY

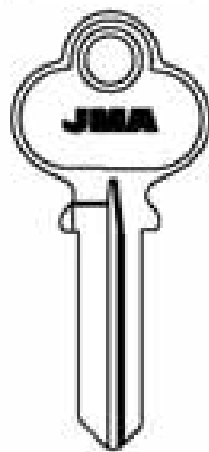

LUC-1D

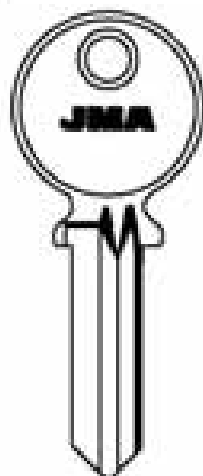

LUC-2

LUMA

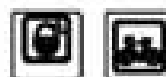
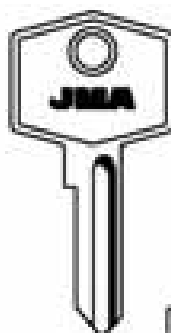

A1101-A1112	A2001-A2012	CM001-AM01E	CM001-CM01E
LUMA-11	LUMA-1D	LUMA-31	LUMA-3D
B3001-B3012	B4401-B4412		
LUMA-21	LUMA-2D	LUMA-41	LUMA-4D

BARTA

PARA-FOR:

LUCKY (RC)

LUMA (E)

LYF (E)

MARIANI (I)

MARQUES (P)

MASTER (USA)

PARA:
FOR:

LYF

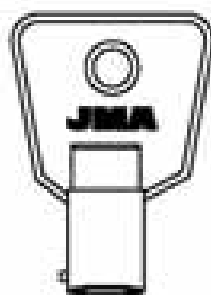

LAT.



LYF-1T

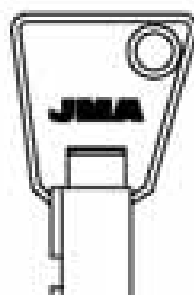

LAT.



LYF-2T

MARIANI

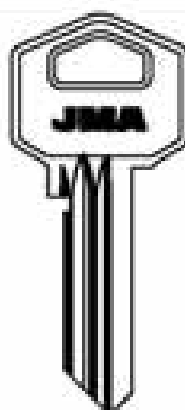

MA-5D

MARQUES



MQ-11 MQ-1D

PARA:
FOR:

MASTER

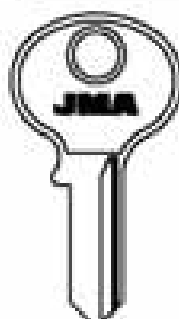

MAS-1 MAS-1D



MAS-2D MAS-22D

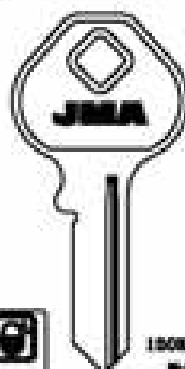

MAS-11 MAS-11D MAS-12D

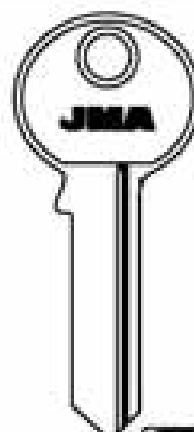

MAS-4D

Copyright by
Aljeandro Altman S.A.
2018

JMA

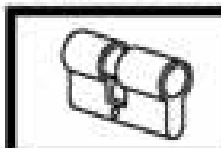

85

PARA-FOR:





MASTER (USA)

MASTER LOCK (TJ)

MCL (RUS)

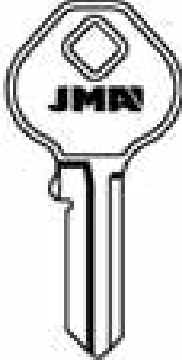
MCM (E)

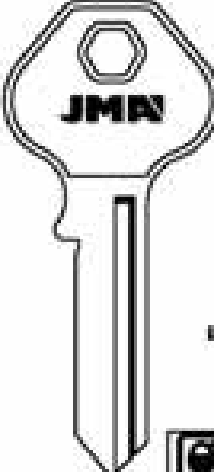
PARA-FOR: MASTER

			
MAS-6	MAS-7 MAS-7D	MAS-8	MAS-9 MAS-9D

PARA-FOR: MASTER

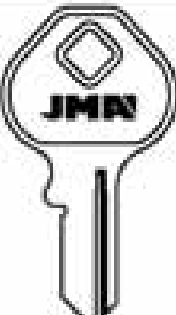
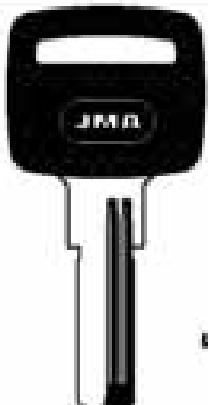
		
MAS-10 MAS-10D	MAS-13D	MAS-15.P

PARA-FOR: MASTER LOCK

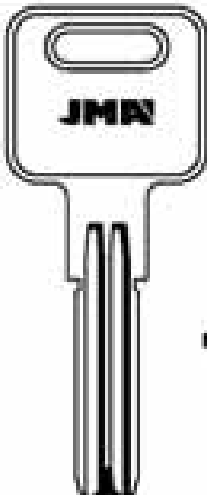
MASL-1

PARA-FOR: MCL

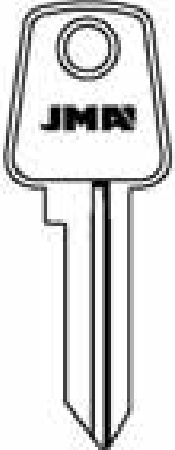

MCL-1D

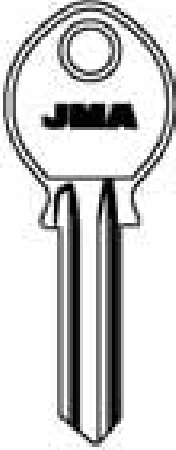
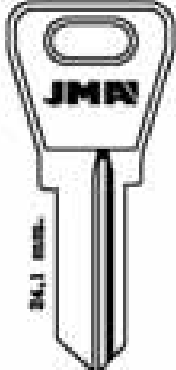
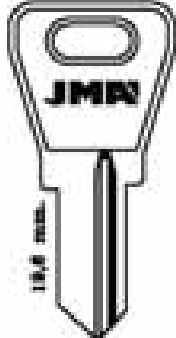
PARA-FOR: MCM

		
MCM-1	MCM-2I MCM-2D	MCM-3I MCM-3D

Copyright by
Algebra Alliant S.A.
2010

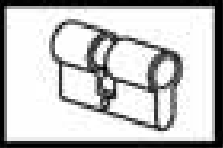
JMA



86

PARA:
FOR:

MCM

PARA-FOR:

MCM (E)

• ALL.
• LAT.
• COL.
• PSEL.
• MTC(X)

• ALL.
• LAT.
• PSEL.

ESAFE-E+E LDR-YETI COFER

MCM-4I MCM-4D MCM-4SS MCM-4EC MCM-11S MCM-5I MCM-5D MCM-6

PARA:
FOR:

MCM

LAT.

ESAFE-TROMER

MCM-7 MCM-8 MCM-10 MCM-12D

PARA:
FOR:

MCM

ALL.
PSEL.

LAT.

MCM-13D MCM-21D MCM-18D

Copyright by
Alejandro Allier S.A.
2010

JMA



PARA-FOR:

MCM (E)

ME-FA (RC)

MECO (D)

MELSMETALL (D)

PARA-FOR:

MCM

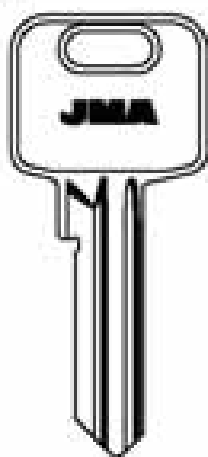

B
MCM-24B

C
MCM-24C

D
MCM-24D

E
MCM-24E

F
MCM-24F

MCM-26



MCM-29D

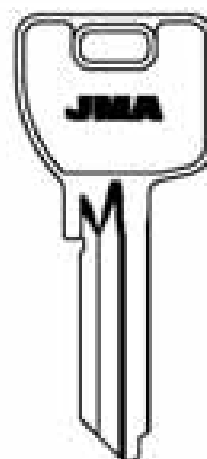

E
MCM-30D

PARA-FOR:

MCM

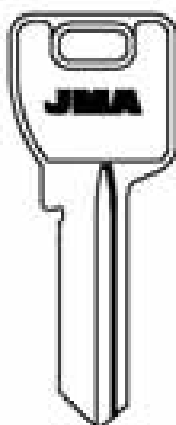

B **C**
MCM-31 MCM-31D

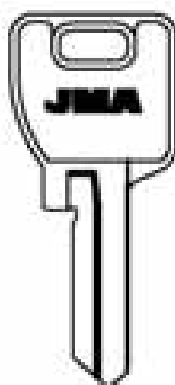

D
MCM-32D

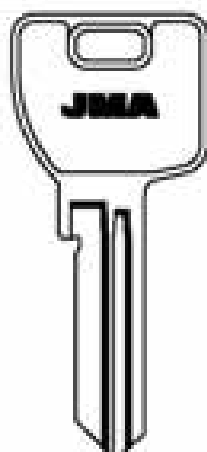

A
MCM-33

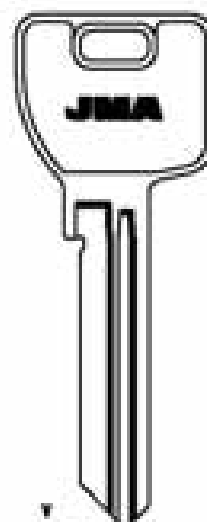

T
MCM-35

PARA-FOR:

ME-FA

MECO

MELSMETALL

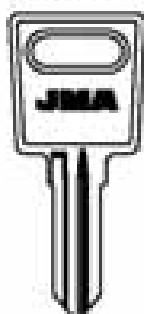

...1-100
BRA-1

BRABANTIA-CLAUSON-CASS BOX
ILUNT

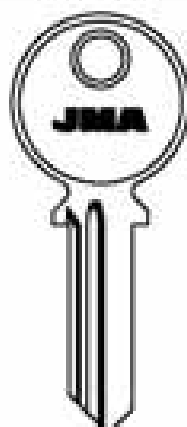

MEC-5D



MEL-1

MEL-4 MEL-4D

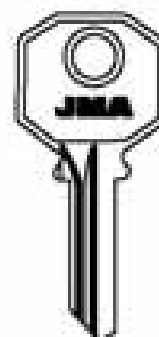

MEL-2D

Copyright by
Alphonse Allotta S.A.
1978

JMA

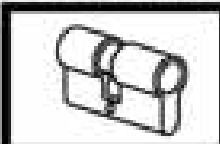

88

PARA:
FOR:

MELSMETALL



MEL-3
HBC

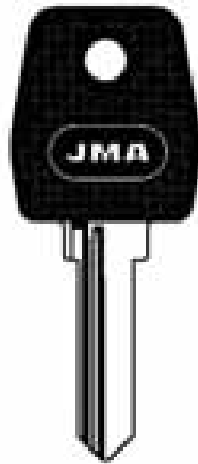

MEL-5.P
SECURITY

MERONI



ALLI
LAT.

T
O A L 9
M
O A L 9
MER-1D

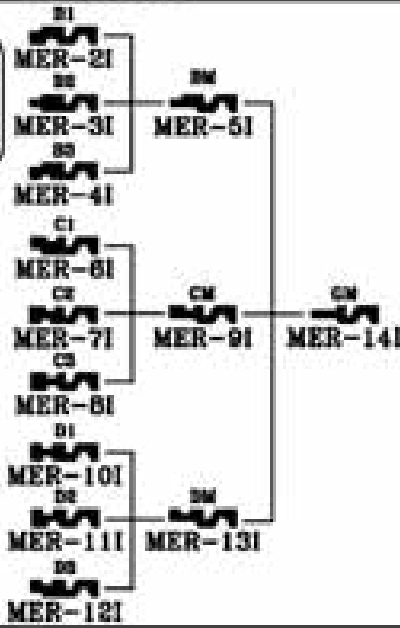

PARA-FOR:

MELSMETALL
(D)

MERONI (I)

METAL (BG)

PARA:
FOR:

MERONI

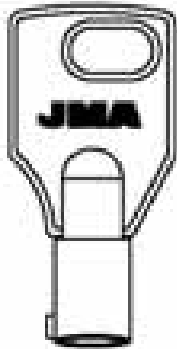

MER-1T



MER-15

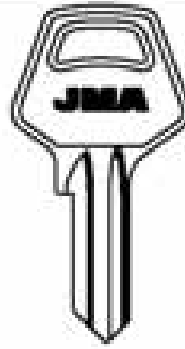

MER-16

1001-1500

LAMA



MER-17

C...3001-3480

C...0-480

...3001-3480

LAMA

PARA:
FOR:

MERONI

METAL

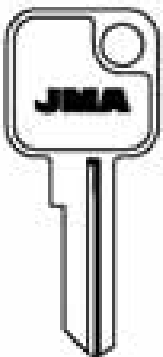

MER-18
PREMI-APRO

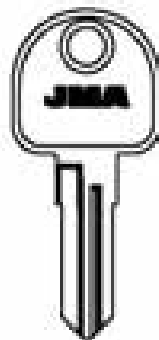

MER-19D



MER-20D
MER-21D

CC

MER-20D

CC

MER-21D

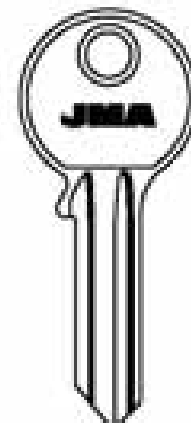





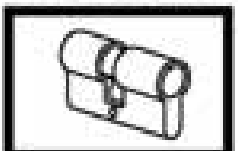



MTL-1 MTL-1D

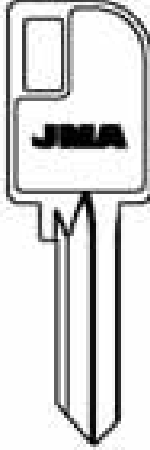

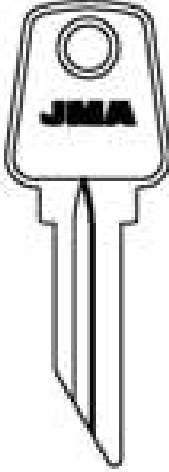
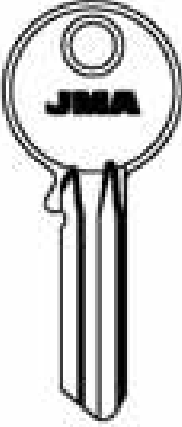





Copyright by
Aljeandro Altman S.A.
2018



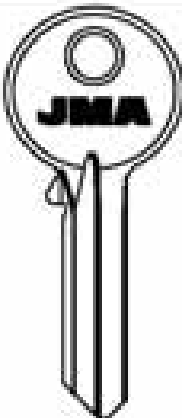
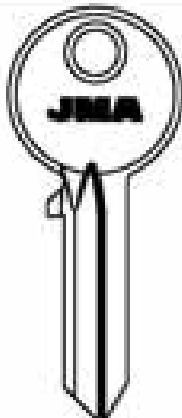



PARA-FOR:

- METALUX (F)
- METEOR (D)
- METIZ (RUS)
- MG MONTI (I)
- MICHEL-SEAT (I)
- MILA (DK)
- MILES (RUS)

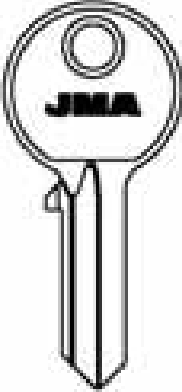
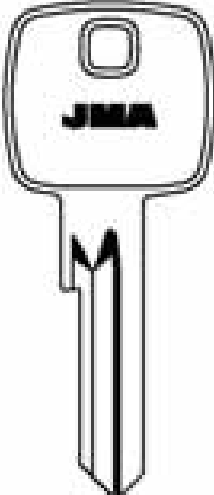
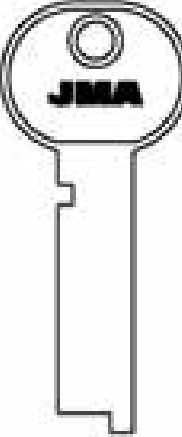
PARA-FOR:	METALUX	METEOR	METIZ	MG (MONTI)
				
	 MET-2D CAR-CITMA	 E.I-800 C.I-800 MTO-1	 MEZ-1D	 MGA-1  MGA-1D

PARA-FOR:	MICHEL-SEAT		MILA	
				
	 MCH-1  MCH-1D OMI-POTENT	 MCH-2  MCH-2D AM-POTENT	 MI-1D	 MI-2D





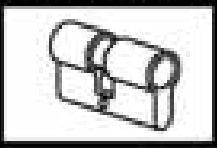

PARA-FOR:	MILA		MILES
			
	 MI-3D	 MI-4D	 MI-5D TRINITY
			 MIL-1

Copyright by
Alpente Altes S.A.
1978

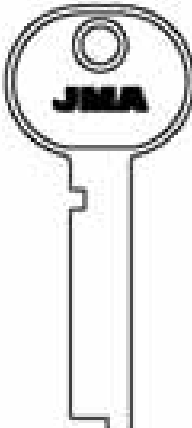

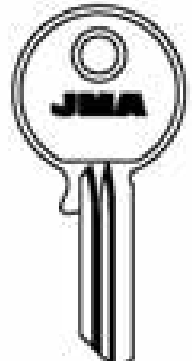

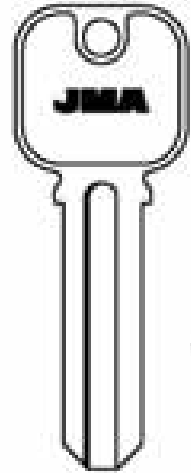
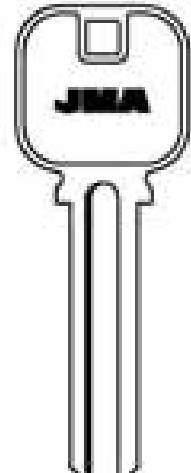



JMA

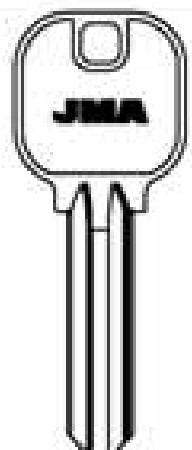

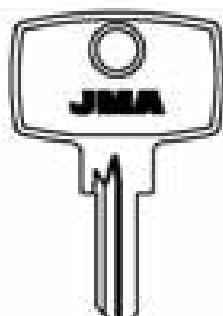

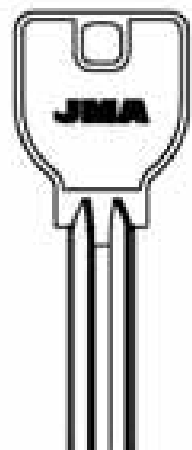

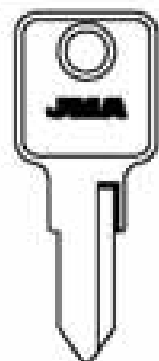

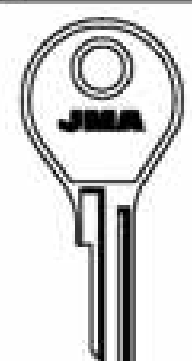

90

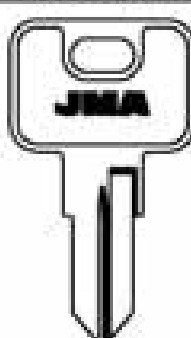
PARA-FOR: MILES   MIL-2	PARA-FOR: MING-TAY   MIN-1D	PARA-FOR: MIWA     MIW-1 MIW-2	
--	--	--	--

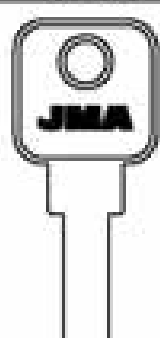
PARA-FOR:
MILES (RUS)
MING-TAY (RC)
MIWA (J)
MLM (F)
MOBELLA (S)

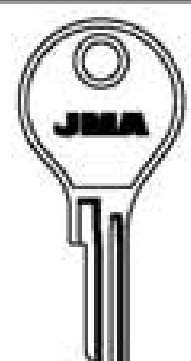
PARA-FOR: MIWA   MIW-3		PARA-FOR: MLM   MLM-1D	
  MIW-4		  MLM-2  MLM-5	

PARA-FOR: MLM   MLM-3		PARA-FOR: MOBELLA   MBL-1	
  MLM-4		  MLM-6  MLM-7	

Copyright by
 Alejandro Altman S.A.
 2018
JMA

ATTENCIÓN: Dimensiones y sus marcas y denominaciones comerciales son solo un ejemplo. ATENCIÓN: Dimensiones de marcas y nombres comerciales de marcas de otros países.
 ATTENÇÃO: Dimensões e suas marcas e denominações comerciais são apenas um exemplo. ATENÇÃO: Dimensões e nomes comerciais de marcas de outros países.

PARA-FOR:

**MOGILEV
(RUS)**

MON (E)

**MONOBLOC
(F)**

**MOSRENTGUEN
(RUS)**

MOTTURA (I)

**M.P. PLODARI
(I)**

PARA-FOR:	MOGILEV	MON	MONOBLOC
		 31,8 mm.	

PARA-FOR:	MOSRENTGUEN		



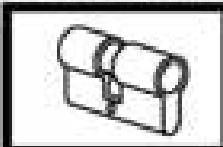

PARA-FOR:	MOTTURA	M.P. PLODARI

Copyright by
Alpacas Altam S.p.A.
1978

JMA

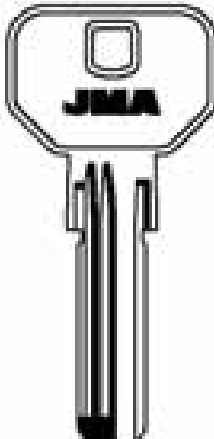
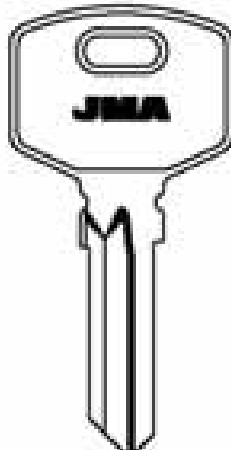
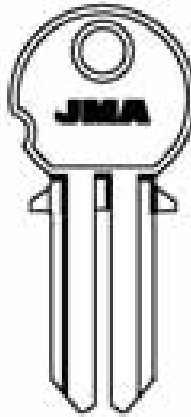







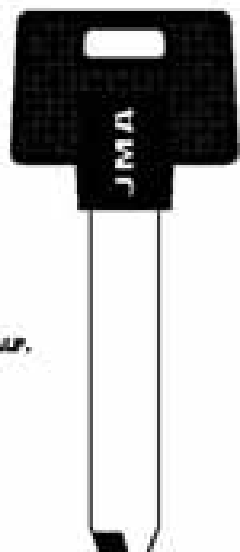

92

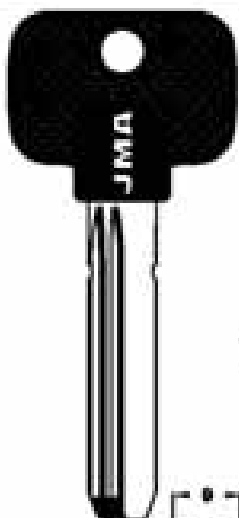
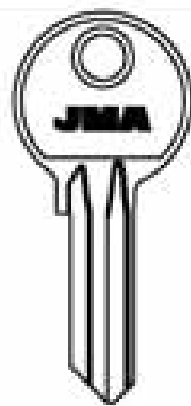
PARA: FOR:	MSM	MSV
		
		 

PARA-FOR:

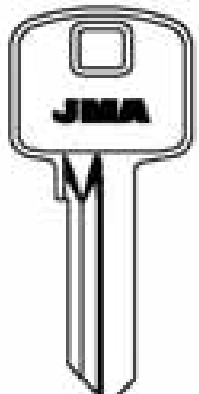
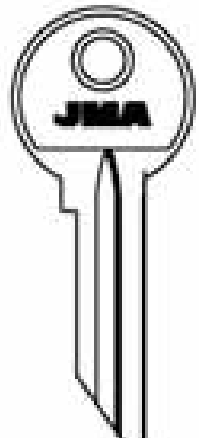
- MSM
- MSV (P)
- MULT.LOCK (IL)
- NOVA (D)
- OCARIZ (E)
- OCTAVO M. (RUS)

PARA: FOR:	MUL.T.LOCK		
			
ALP.	MUL-T3.PL MUL-T4.P MUL-T5.P	ALP.	MUL-T3.PI ¹ MUL-T6 MUL-T6D
CAMEA		CAMEA	

PARA: FOR:	MUL.T.LOCK	NOVA	OCARIZ	OCTAVO M.
				
ALP.				
MUL-T10.P ¹	NO-1 ARIS-TOP	OCA-1D OCA-2D	SM-1D	

Copyright by
Algebra Altesa S.A.
2010

JMA

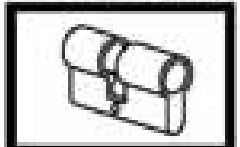









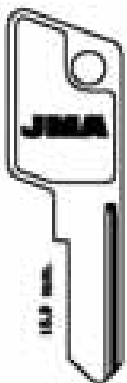
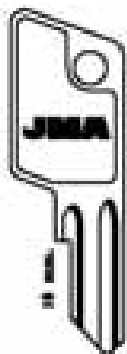
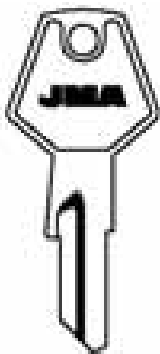
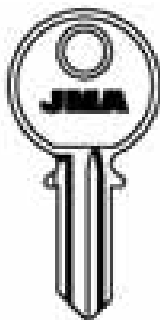



93



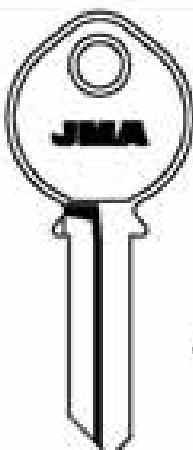







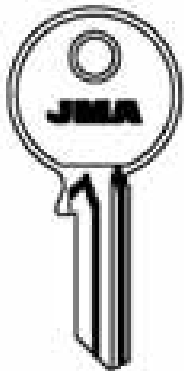

PARA-FOR:

OFITA (E)

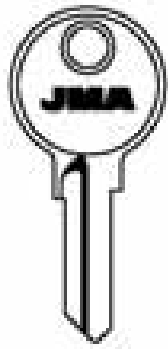
OJMAR (E)

PARA: FOR:	OFITA	OJMAR
	 	 
	 OF-1	 OJ-10
	 OF-2	 OJ-21

PARA: FOR:	OJMAR
	  
	 OJ-31
	 OJ-3D
	 OJ-4D
	 OJ-51

PARA: FOR:	OJMAR
	       
	 OJ-61
	 OJ-6D
	 OJ-K
	 OJ-L
	 OJ-M
	 OJ-9D

Copyright by
Alfonso Altom S.A.
2018

JMA

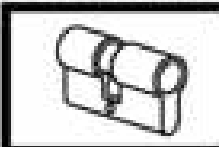

PARA:
FOR:

OJMAR

PARA-FOR:

OJMAR (E)

OLIVA (I)

OLIVETTI (I)

OMA (I)

OMECA (I)



OJ-10



OJ-11



OJ-12



OJ-13



OJ-16



OJ-17

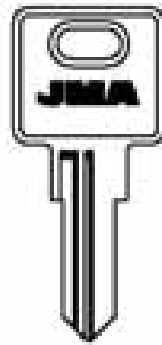

OJ-14



OJ-15



OJ-18.P

BURGO - BURG - BUKU - BUKEN - BIFLEX - BISO - STUMPF METALL

BURG

PARA:
FOR:

OJMAR

OLIVA

OLIVETTI



OJ-19

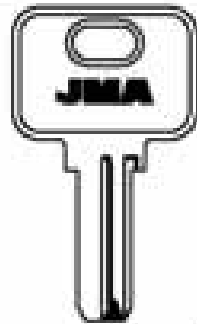

ALP.



OJ-Q

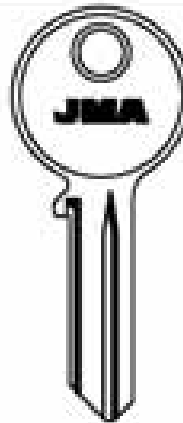

OL-SD

FERRABLOCCO - PD - PREFER



OLIV-1

PARA:
FOR:

OMA

OMECA

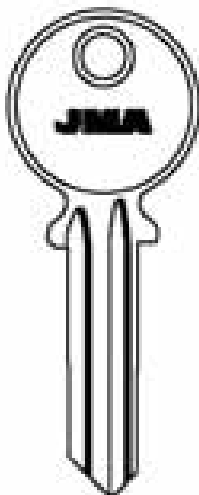

OA-1

C.A.R.R.

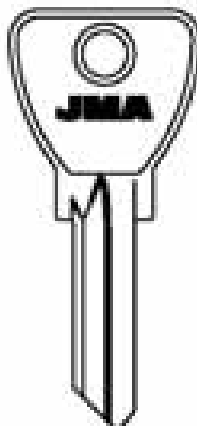

OMC-1D

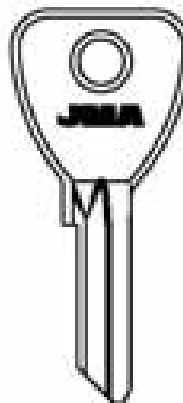

OMC-2D

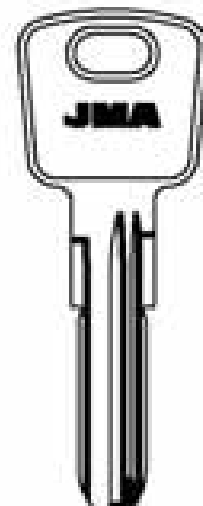

OMC-3

SANTOS

Copyright by
Allegretto Alessio S.A.
1988

LIT.



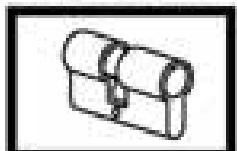







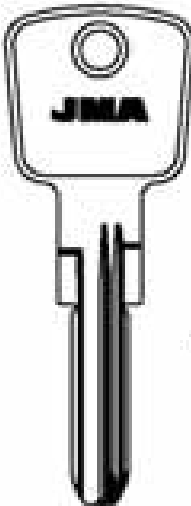
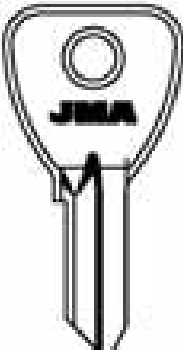
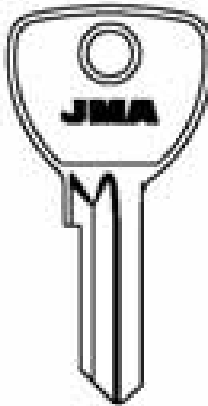
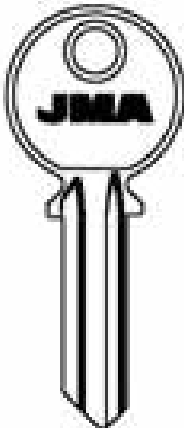





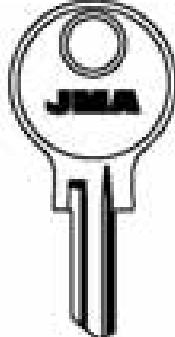

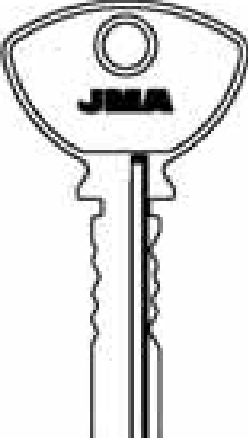
JMA

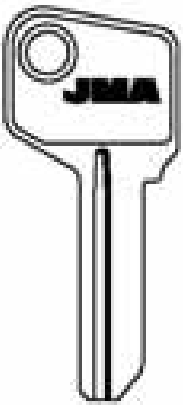

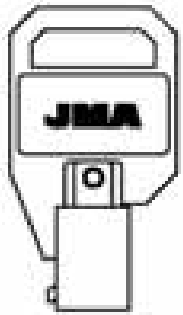
95

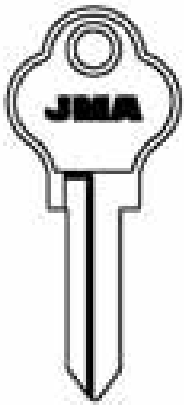
PARA-FOR:

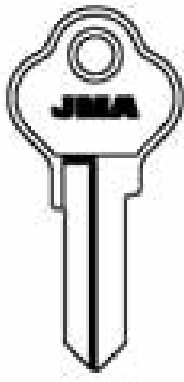

- OMEC (I)
- OMIV (I)
- O.M.R. (I)
- ORDO (F)
- ORION-NOVOX (F)
- ORO (IL)
- ORSHA (RUS)
- P&C I. (USA)
- PADO (BR)

	PARA-FOR: OMEC		OMIV
	    	LAT.	  CIB-877
	PARA-FOR: O.M.R.	ORDO	ORION-NOVOX
	   MICHEL SEAT	  OR-II	  DECAVELLE
	PARA-FOR: ORSHA	P&C I.	PADO
	  ORK-1D	  PCI-1T	  PAD-1D
			  PAD-2D

Copyright by
Algebras Almas S.A.
1988

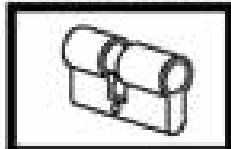
JMA

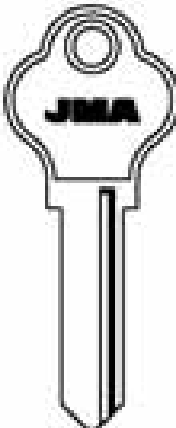
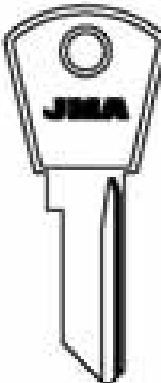
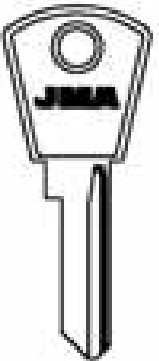
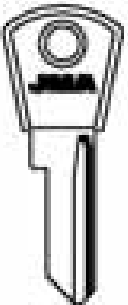
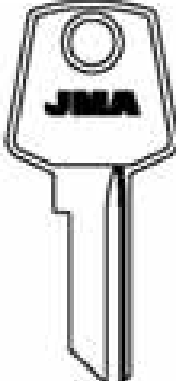
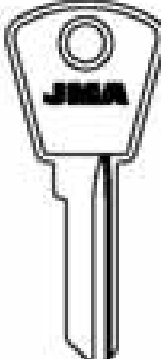
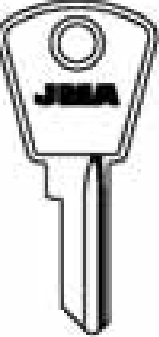
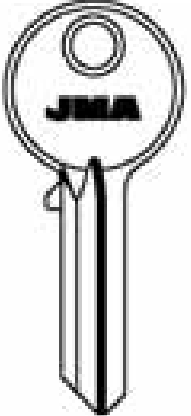
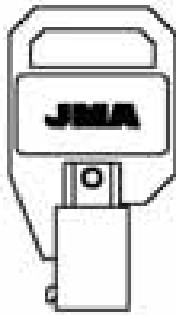
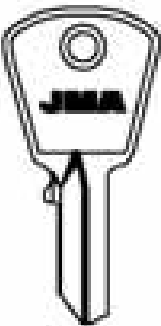
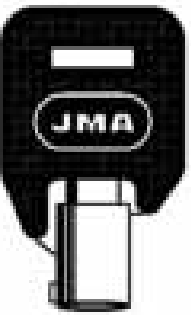
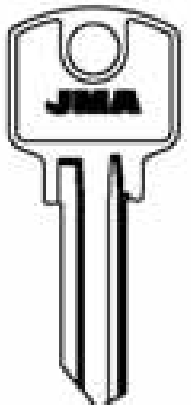

<p>PARA: FOR: PADO</p>  <p>PAD-3 PAD-3D</p>	<p>PAPAIZ</p>  <p>48-52-55-70 PAP-1</p>  <p>PAP-2</p>  <p>PAP-3</p>			<p>PARA-FOR:</p> <p>PADO (BR) PAPAIZ (BR) P.C. (D) PENZMASH (RUS)</p>
<p>PARA: FOR: PAPAIZ</p>  <p>PAP-4</p>  <p>PAP-5</p>  <p>PAP-6</p>	<p>P.C.</p>  <p>1 AL 8 PC-1D ETNA-FES-FPS-FRAL-SANTON</p>			
<p>PARA: FOR: P.C.</p>  <p>PC-1T</p>  <p>1 AL 8 PC-2D</p>  <p>PC-3T.P</p>	<p>PENZMASH</p>  <p>PEN-1 PEN-1D</p>		<p>Copyright by Algebra Almas S.A. 2010</p>   <p>97</p>	

PARA-FOR:

**PENZMASH
(RUS)**



**PETROZAVODSK
(RUS)**







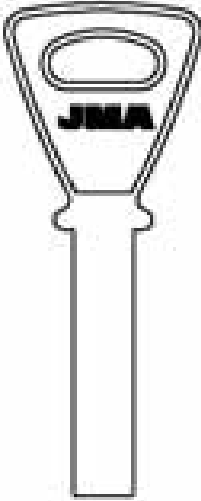
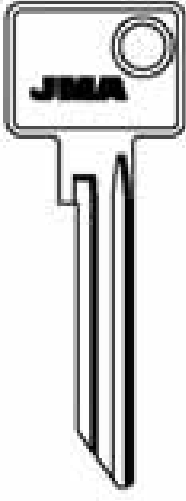
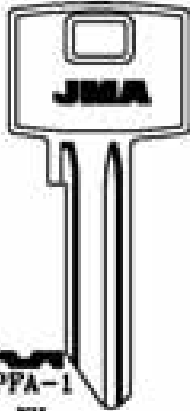

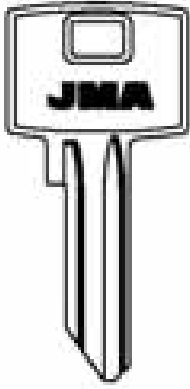

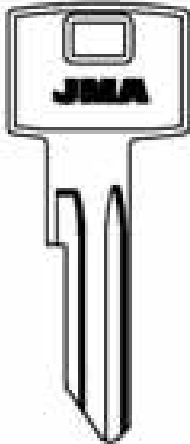



**PFAFFENHAIN
(D)**

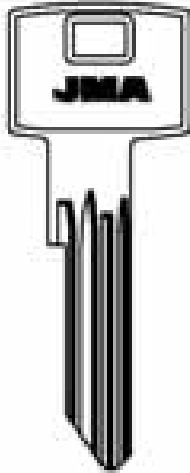

**PHILLIPS
(MEX)**

PHOENIX (GB)

PICARD (F)

	PARA-FOR: PENZMASH	PARA-FOR: PETROZAVODSK	PARA-FOR: PFAFFENHAIN	
	 PEN-2	 PET-1	 PFA-1  PFA-2  PFA-5	 PFA-3

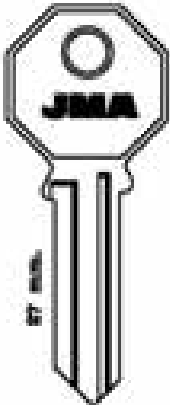
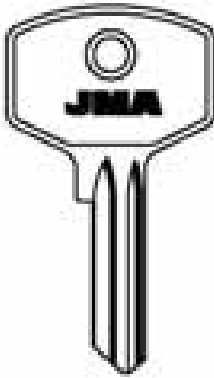
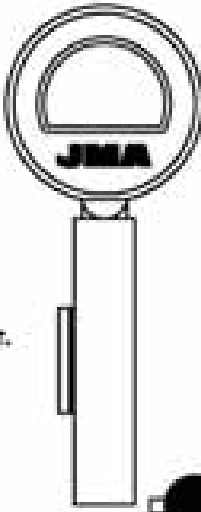
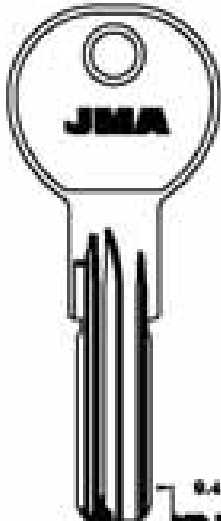
	PARA-FOR: PFAFFENHAIN			
	 PFA-4	 PFA-13D  PFA-14D  PFA-15D  PFA-10D  PFA-16D  PFA-11D  PFA-17D  PFA-12D  PFA-18D	 PFA-6  PFA-8D	 PFA-7D  PFA-8D  PFA-9D

	PARA-FOR: PHILLIPS	PARA-FOR: PHOENIX	PARA-FOR: PICARD	
	 PHI-52	 PHO-1	 PIC-1E	 PIC-8D  PIC-9D

Copyright by
Aljondro Altona S.A.
2010

JMA

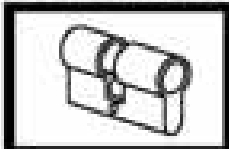

98

PARA:
FOR:

POLLUX

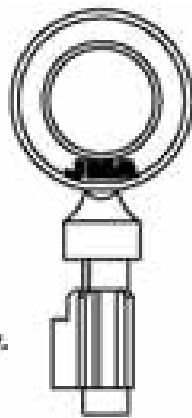
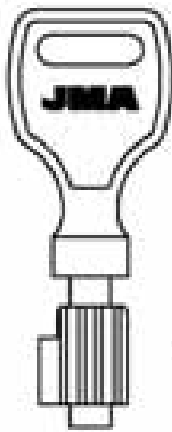

LAT. LAT.

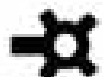
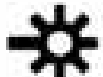
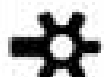

POL-3TEC

POL-5TEC

POL-4E

POTENT

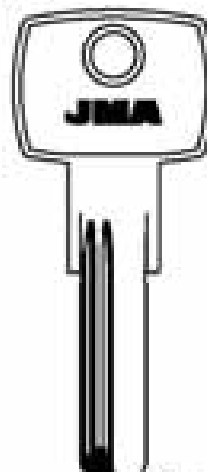
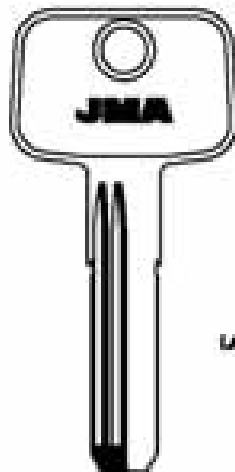

LAT.



PTN-1D



PTN-2D

PARA-FOR:

POLLUX (F)

POTENT (I)

PREFER (I)

PARA:
FOR:

PREFER

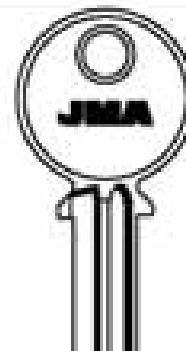
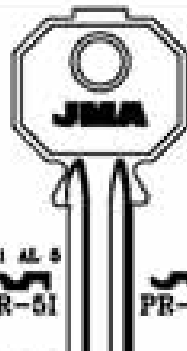
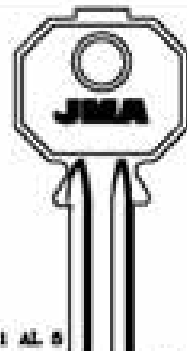
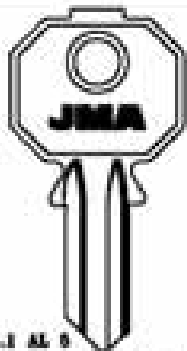

PR-1



PR-1D



PR-4I



PR-4D



PR-5I



PR-5D



PR-6



PR-7



PR-12



PR-8



PR-19



PR-2



PR-3

UNIFOR



PR-10



PR-11

BLOCUS-CAP-CIB-JIP
PASTORE-PRIMO



PR-12

BLOCUS-CAP-CIB-JIP
PASTORE-PRIMO

PARA:
FOR:

PREFER

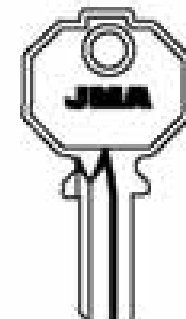
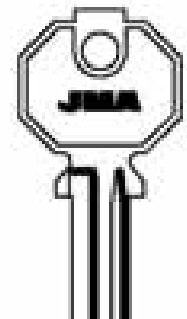
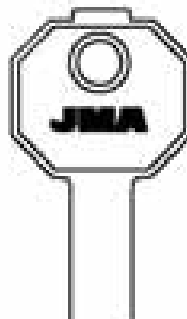
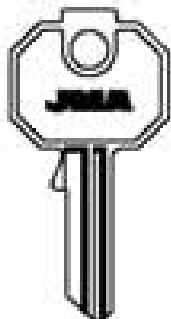

PR-9

PR-9D

PR-13

PR-20

PR-20D

PR-14

601-700

PR-15D

MYTALCASTELLI

LIPS-PAB-SVEDA-YACO

Copyright by
Allegretto Alessio S.A.
2010

JMA



99

PARA-FOR:

PREFER (I)









REGAL (GB)

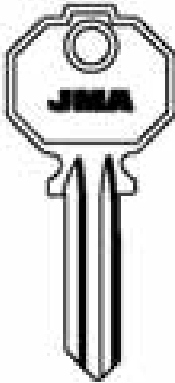
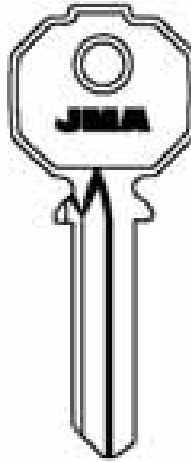

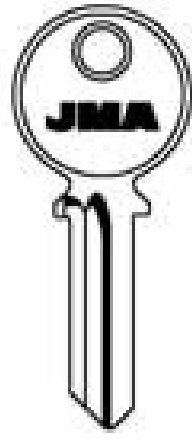

RENZ (D)





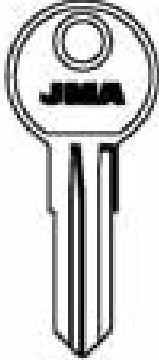
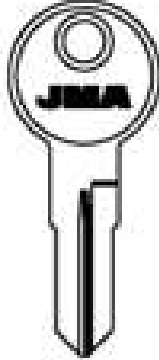
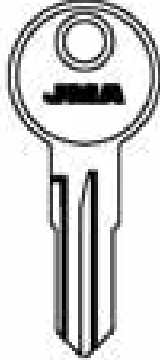
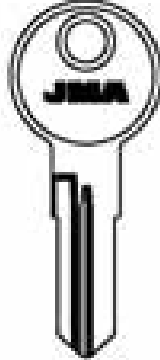

REX (DK)

RGM (E)

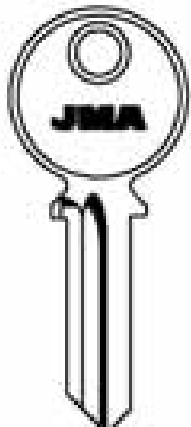
RIAZIAN (RUS)

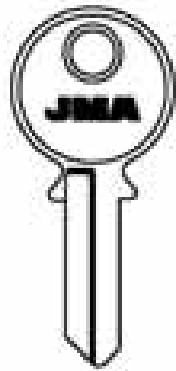
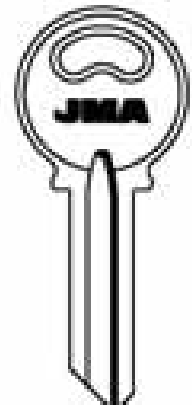
PARA-FOR:	PREFER			REGAL
				
	  PR-16 PR-16D	 PR-17D	 PR-18 <small>TWAC</small>	 REG-1D

PARA-FOR:	RENZ			
				
	 RE-1	 RE-2 RE-2D	 RE-3D	 RE-5D

PARA-FOR:	REX	RGM		RIAZIAN
				
	 REX-1D	 RGM-1I RGM-1D	 RGM-2	 RAZ-1D

Copyright by
Alejandro Allsina S.A.
2010

JMA

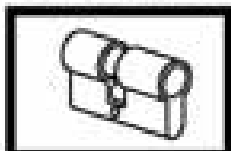

100

PARA-FOR:

RONIS (F)

PARA:
FOR:

RONIS

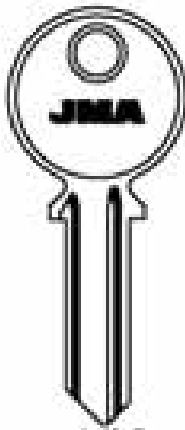

...1 AL 9
A/...1 AL 9
...A/E 1 AL 9
M...1100-1800
RO-101 RO-10D

FM
RO-181
LIONA LLOY-LAPERCHÉ

FL
RO-191 RO-19D
LAPERCHÉ

FK
RO-201 RO-20D
FONTAINE-LAPERCHÉ

ET
RO-211 RO-21D

RO-221

RO-23D

RO-10D

ANTAR
BLAQUE
BAG
DEDELAUBAIN
DELTA
DERLOCHE
DESPIRE
DC
EMGE
EQUENATIN
FONTAINE
FORINDEI
GOLLOT
GUIDOTTI
JIP
LAPERCHÉ
LORNA-LLOE
MAFOR
MONDIAL
MORSALE
NUMIDA
FM
SIDA
STRANLER
STUY
VEGA

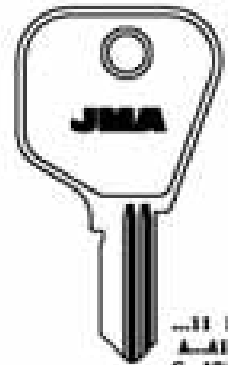

...11 1-700
A...1-700
C...101-800
E...1-1000
T...1-900
TA...1-824
CY...1-800
...F1-500
IF...1-81
RO-11D

...101-700
E...1-1000
T...107-400
Y...101-800
RO-11I

PRIORITY-GENAULT
ARSA-BADY-EMPLEX

PARA:
FOR:

RONIS

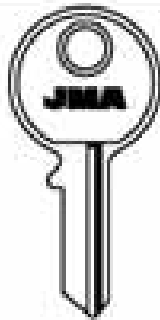

RO-121 RO-12D
M...201-900 TAY
RO-161 RO-16D
BURG-STRAFOR

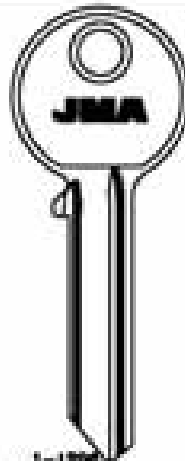

...1-1800
...0 AL 9 AL 9
...1 AL 9
RO-241 RO-24D
ANTAR-LAPERCHÉ-SIDA

FM
RO-251 RO-25D
LAPERCHÉ

FL
RO-261 RO-26D
LAPERCHÉ

FK
RO-271 RO-27D
LAPERCHÉ

RO-281 RO-28D

RO-29D



RO-31D
SOLE

PARA:
FOR:

RONIS

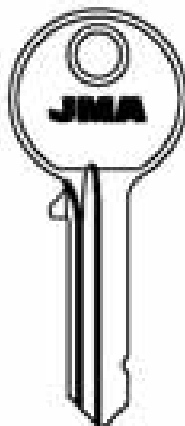

RO-34D
CATOR

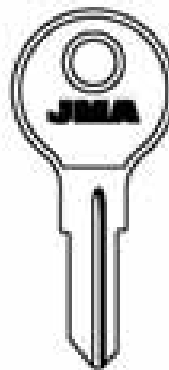

RO-36D
JD

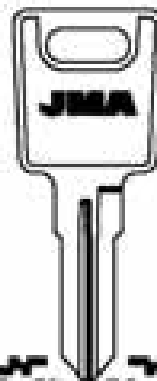

RO-37 RO-37D

RO-38 RO-38D

RO-41

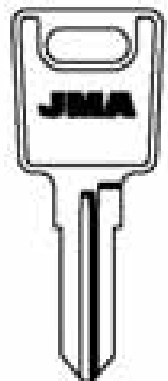

RO-39

RO-40 RO-40D

Copyright by
Alpastris Altina S.A.
1978

JMA

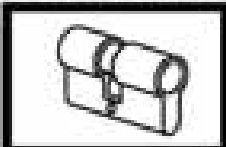

102

PARA:
FOR: **ROSSETTI**

ROYAL

RUKO

PARA-FOR:



LAT.



ROSE-1

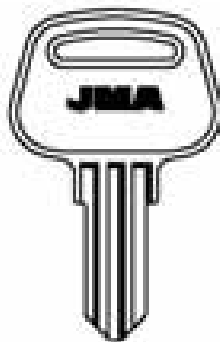

ROY-1

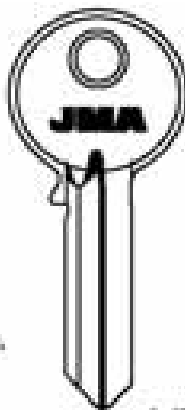

ALL.



DIFA



RU-21



RU-2D



RU-3D



RU-4D



RU-10D



RU-TL

ROSSETTI (D)

ROYAL (RC)

RUKO (DK)

PARA:
FOR: **RUKO**



RU-5I



RU-5D



RU-K



RU-KD



RU-6I



RU-L



RU-9I



RU-9D



RU-M

ASSA



RU-11D



RU-12D



RU-14D



RU-15

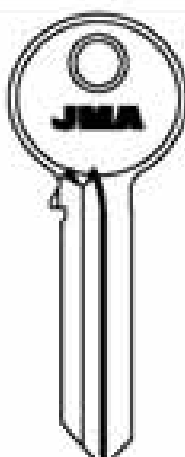

RU-7D



RU-GK7



RU-GL7



RU-GM7



RU-GS7



RU-8D

PARA:
FOR: **RUKO**



RU-13D

ASSA

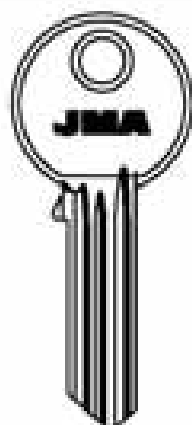

RU-GC



RU-GK



RU-GL



RU-GS



RU-16D

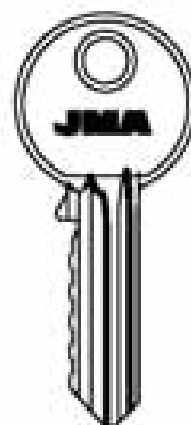

RU-GM

Copyright by
Allegretto Alfano S.A.
2010

JMA



103

PARA-FOR:

RUSSIA (RUS)

**RUSSWIN
(USA)**

SABT (KW)





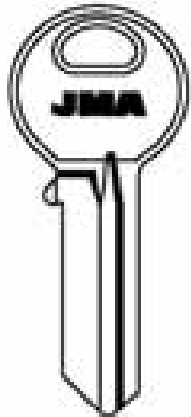
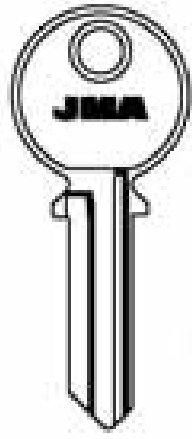

SAM (RUS)



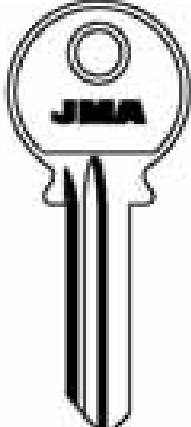
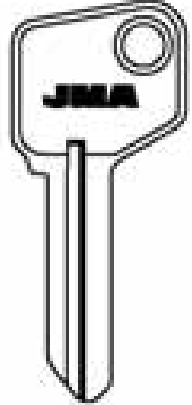
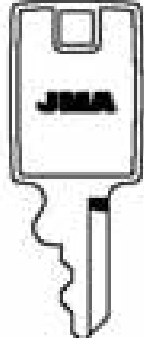



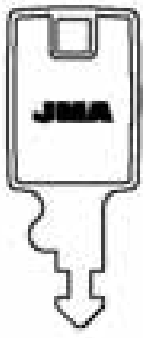
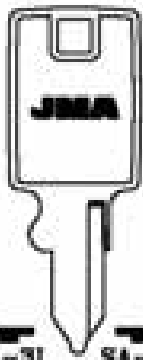
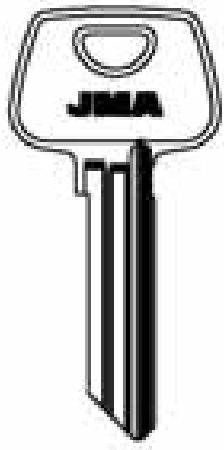
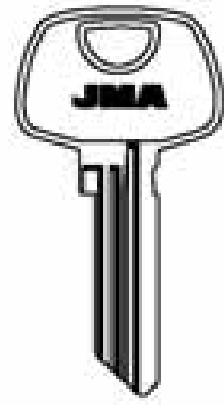

**SAMSONITE
(USA)**

**SARGENT
(USA)**

PARA-FOR:	RUSSIA		RUSSWIN	
				
				

LAT.

PARA-FOR:	SABT	SAM		SAMSONITE
				
				 170 B 

PARA-FOR:	SAMSONITE		SARGENT	
				
		 SA-3I  SA-3D SE 041 SE 052 SE 053 SE 104 SE 105 SE 106 SE 107  SA-4	 LN SAR-1  LN SAR-1D	 S SAR-2D BROCARD-BROVA

Copyright by
Alpacas Alfas S.A.
1978

JMA

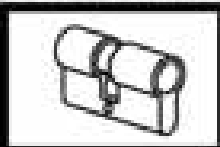

104

PARA:
FOR:

SARGENT

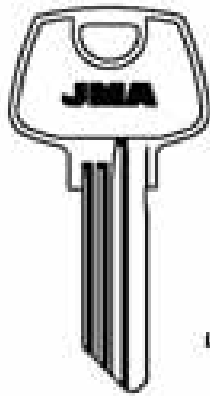

LAT.

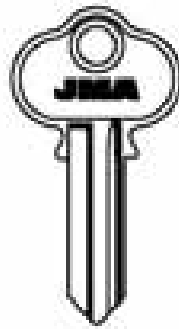

LAT.

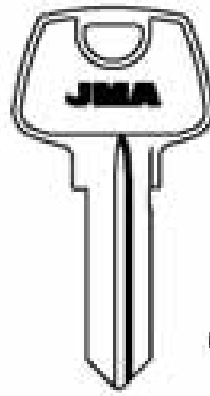

LAT.



SAR-3D



SAR-4



SAR-4D



SAR-5D



SAR-6

SAR-6D

PARA-FOR:

SARGENT
(USA)

SATURN (D)

SCHÄRER
(USA)

SCHLAGE
(USA)

PARA:
FOR:

SATURN

SCHÄRER

SCHLAGE

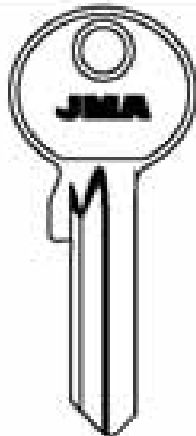

SAT-1D

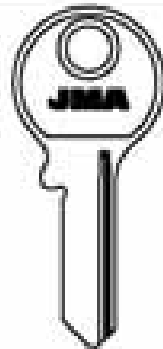

SAT-2

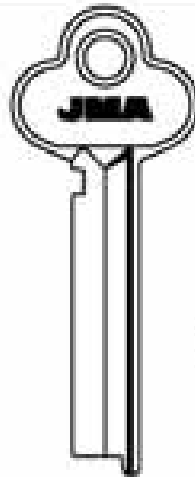

LAT.



SHR-1

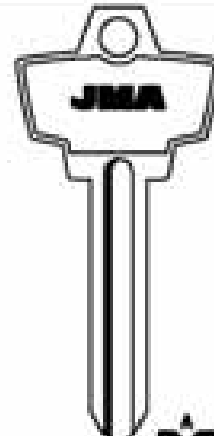

SLG-1



SLG-2

EPO

PARA:
FOR:

SCHLAGE



LAT.



SLG-3



SLG-13



SLG-11



SLG-15



SLG-12



SLG-21



SLG-22



SLG-23



SLG-24



SLG-25



SLG-14

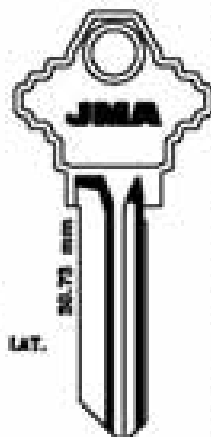

LAT.



SLG-4



SLG-8



SLG-5



SLG-10



SLG-9



SLG-19



SLG-18



SLG-16



SLG-17



SLG-6

ACE

Copyright by
Alejandro Allina S.A.
2010



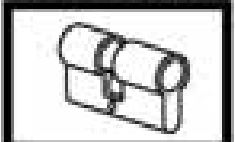







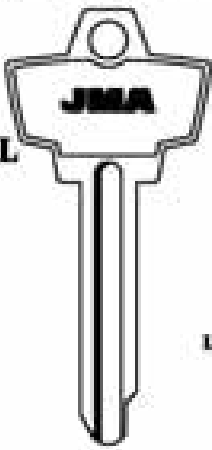

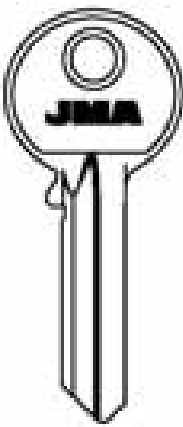

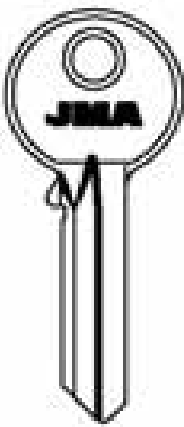

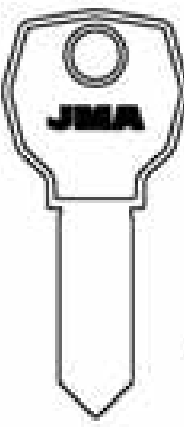

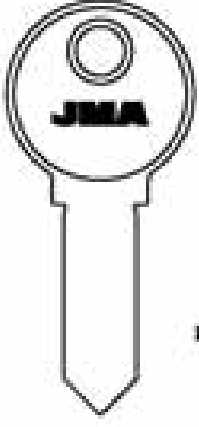
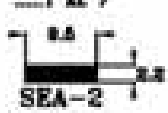
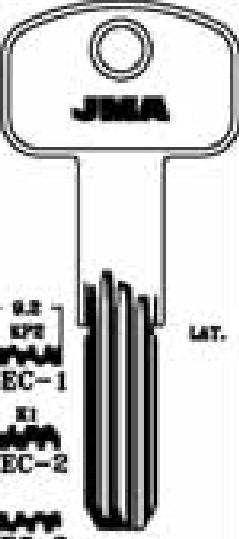

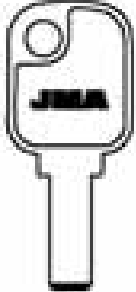

JMA

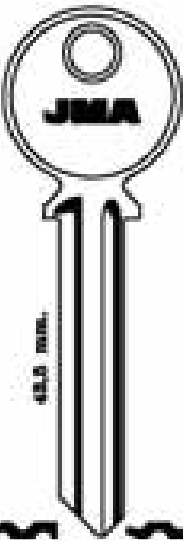

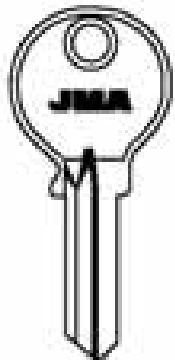
105

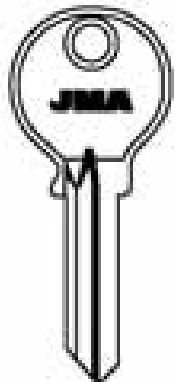
PARA-FOR:

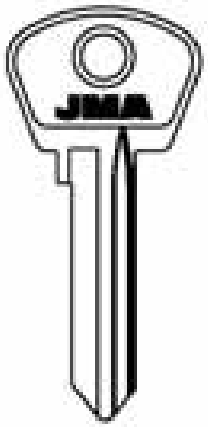





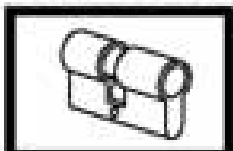

- SCHLAGE (USA)**
- SCHLECHTENDAHL (D)**
- SCHUCO (D)**
- SEA (CH)**
- SECUREMME (I)**
- SECURITAL (I)**
- SELECT (F)**
- SELIVANOVSK (RUS)**

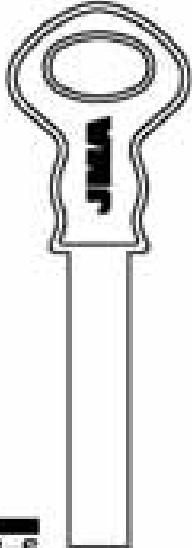

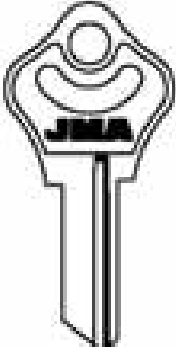

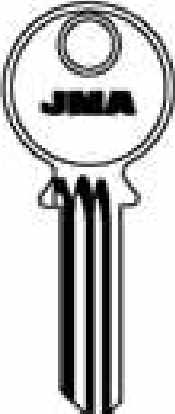

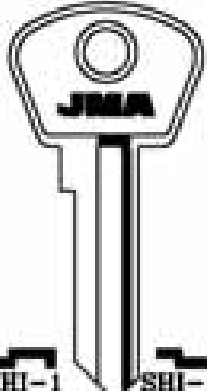

	<p>PARA-FOR: SCHLAGE</p>  <p>LAT.</p>  <p>SLG-7</p>	<p>PARA-FOR: SCHLECHTENDAHL</p>  <p>LAT.</p>  <p>SCH-1D</p> <p>CASI-BUTLA-NORDWEST</p>	<p>PARA-FOR: SCHUCO</p>  <p>LAT.</p>  <p>SCC-1D</p>	<p>PARA-FOR: SEA</p>  <p>LAT.</p>  <p>SEA-1</p> <p>SECURITA-BASLER-YONMAR</p>		
	<p>PARA-FOR: SEA</p>  <p>LAT.</p>  <p>SEA-2</p> <p>SECURITA-BASLER-YONMAR</p>	<p>PARA-FOR: SECUREMME</p>  <p>LAT.</p>  <p>SEC-1 SEC-2 SEC-3</p>	<p>PARA-FOR: SECURITAL</p>  <p>LAT.</p>  <p>SCR-1</p> <p>BYE</p>	<p>PARA-FOR: SELECT</p>  <p>LAT.</p>  <p>SEL-11 SEL-1D</p>		
	<p>PARA-FOR: SELECT</p>  <p>LAT.</p>  <p>SEL-21 SEL-2D</p>			<p>PARA-FOR: SELECT</p>  <p>LAT.</p>  <p>SEL-3D</p>	<p>PARA-FOR: SELECT</p>  <p>LAT.</p>  <p>SEL-4D</p>	<p>PARA-FOR: SELIVANOVSK</p>  <p>LAT.</p>  <p>SL-1</p>

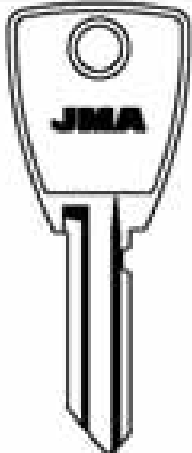

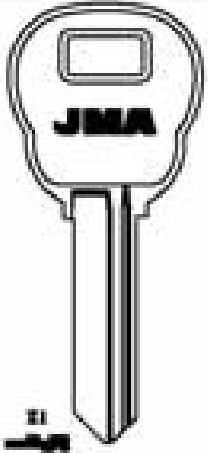

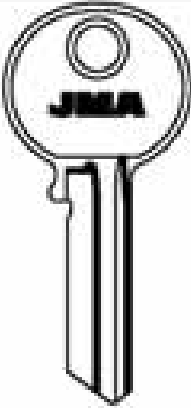

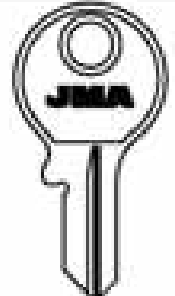

Copyright by
Alejandro Allmon S.A.
2010

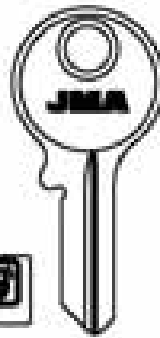
JMA

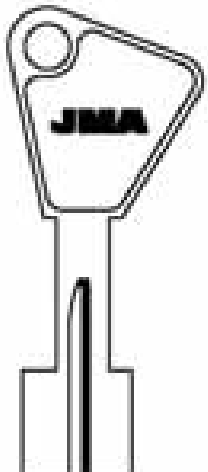

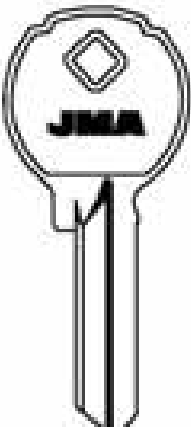



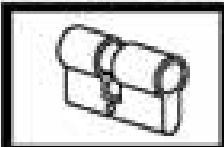



PARA: FOR:	SERRETA	SHANGAI	SHAW	SHILUTE
  7-S	  SHA-1 <small>CINA</small>	  SH-11 <small>BYT-YAUGHN-YALE</small>	  SHI-1	PARA-FOR: SERRETA (E) SHANGAI (RC) SHAW (GB) SHILUTE (RUS) SIMECA (CH) SIS (I)
PARA: FOR:	SIMECA			SIS

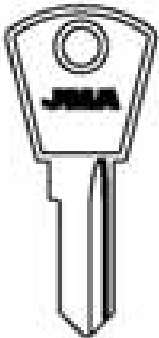



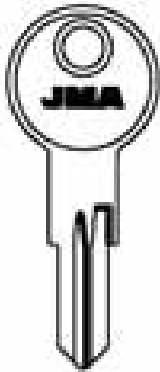



  SM-1 <small>GUTLER-KATE-ORMA SEAM-SIMATIC</small>	  SM-2 <small>40</small>  SM-3	  SM-4	  SIS-1 <small>FEL</small>
--	---	--	---

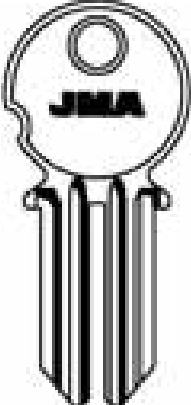



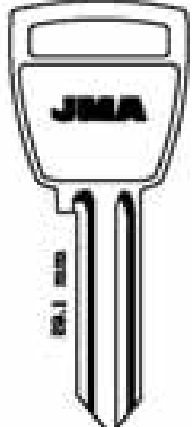

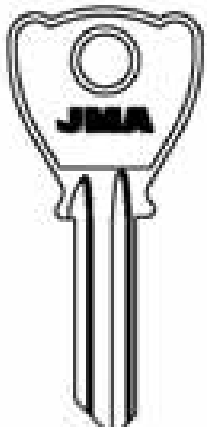

PARA: FOR:				SIS			
  SIS-2  SIS-6	  SIS-3	  SIS-4D <small>LABOLASIT</small>	  SIS-5D	<p>Copyright by Aljandre Alfaro S.A. 2010</p>   <p>107</p>			

PARA-FOR:

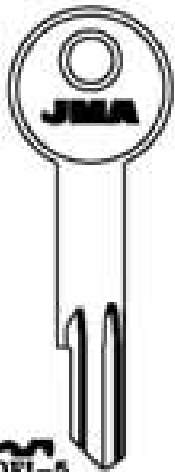
- SIS (I)
- SISO (I)
- SJL (RUS)
- SOFER (P)
- SOFI-SONAFI (P)
- SOLER (E)
- SOPRANO (BR)

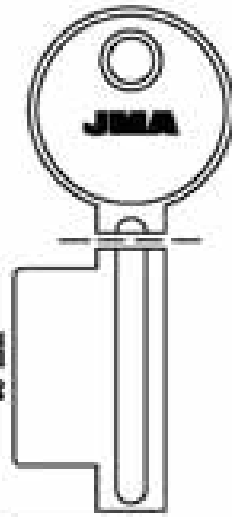
PARA-FOR:	SIS	SISO	SJL
	   	  <small>EVERGOOD-JMA</small>	 

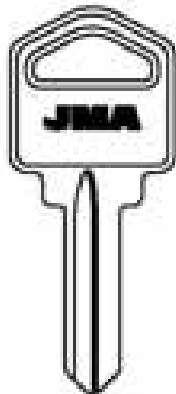
PARA-FOR:	SOFER	SOFI-SONAFI		
	  <small>ML</small>	 	 	 

PARA-FOR:	SOFI-SONAFI	SOLER	SOPRANO
	   	 	 

Copyright by
Alpex Alfa S.A.
2018

JMA

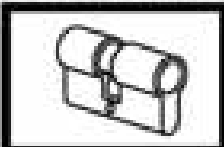

108

PARA:
FOR:

SOS

PARA-FOR:

SOS (F)

SPIDER (IL)

SQUIRE & SONS
(GB)

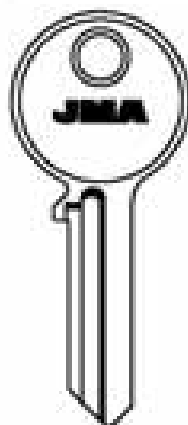

SOS-1D

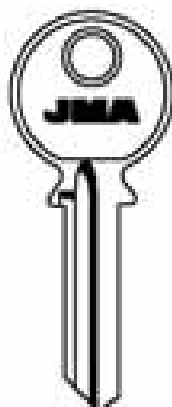

SOS-2D



SOS-3



SOS-4D

PARA:
FOR:

SOS

SPIDER

SQUIRE & SONS



SOS-5

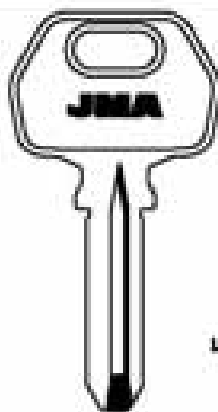

LAT.



CAVIERI-CODICI-LOCKING



SQ-1

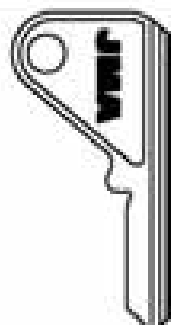

SQ-2

PARA:
FOR:

SQUIRE & SONS

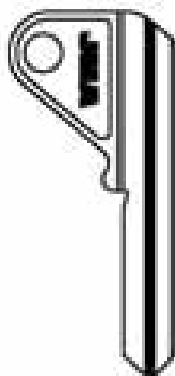

SQ-3D



SQ-4



SQ-5D

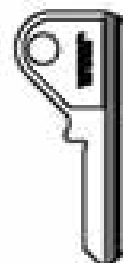

SQ-6

Copyright by
Algebra Alessi S.A.
2018

JMA

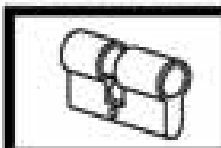

109

PARA-FOR:







**SQUIRE & SONS
(GB)**



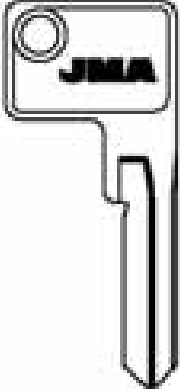
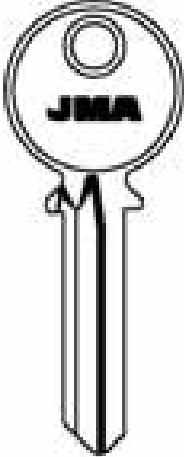





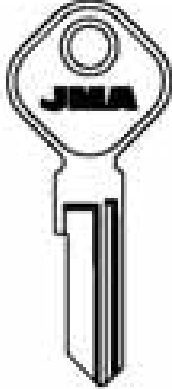

**STA LOCK
(GB)**

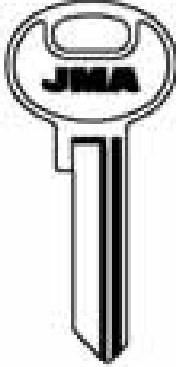
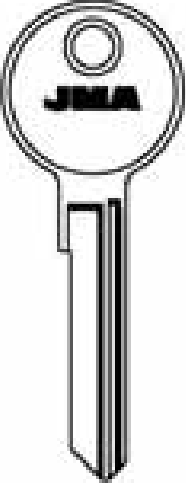





STAR (J)

STARLET (D)

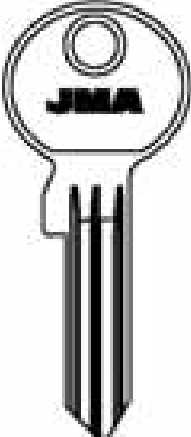
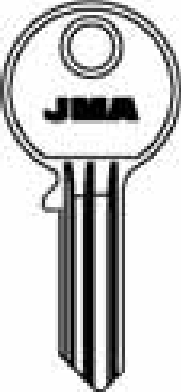
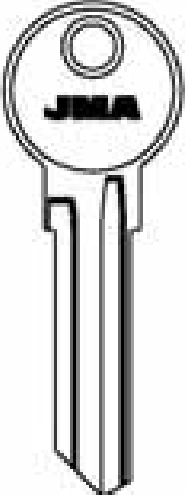
**STEKLOMASH
(RUS)**

PARA-FOR:	SQUIRE & SONS		STA-LOCK	
				
	 SQ-7	 SQ-8D	 STL-1D SECURE	 STL-2I SECURE

PARA-FOR:	STAR							
								
	 STA-1	 STA-1D	 STA-2	 STA-2D	 STA-3	 STA-3D	 STA-4	 STA-4D

PARA-FOR:	STAR	STARLET		STEKLOMASH
				
	 STA-5	 STA-5D	 ST-1I	 ST-2
				 STK-1

Copyright by
Magister Alfas S.A.
1988



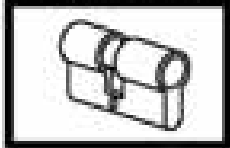





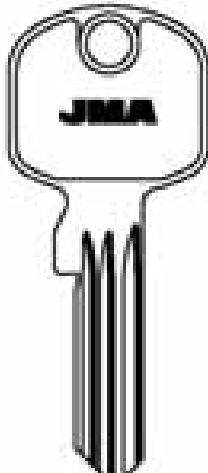



JMA



110



PARA FOR: **STEM**





 STE-8D
 STE-7
 STE-6
 STE-5D  STE-12
 STE-4  STE-11
 STE-3  STE-10
 STE-1  STE-2D  STE-9D

CE CE

STREBOR





 STR-1  STR-2
TI...300-300
INCOGNIT

PARA-FOR:
STEM (D)
STREBOR (GB)
STS (E)

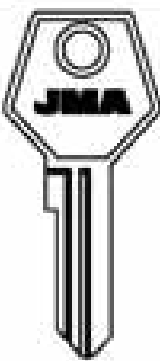
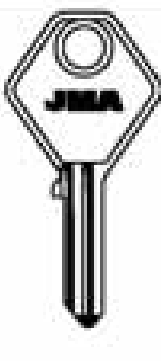



PARA FOR: **STREBOR**

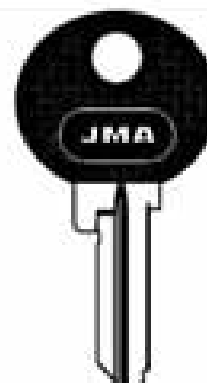

 STR-4  STR-5
S.L.1-70





STS

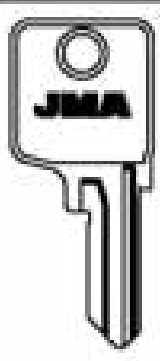

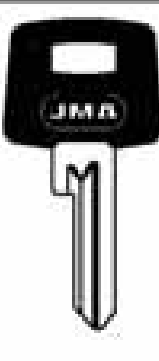
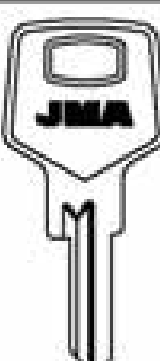
ALLI.
LAT.
 STR-11  STR-10
 STR-28  STR-1D.P

PARA FOR: **STS**

 STR-31  STR-3D
ITV  STR-4D
ITV  STR-4D.P
ITV  STR-6D
ITV

Copyright by
 Alejandro Altamir S.A.
 2018

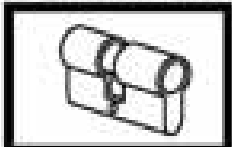
PARA-FOR:

STS (E)

STUBLINA (SCG)

STUMPF (D)

STUV (D)

PARA-FOR: **STS**

STS-7D STS-12D STS-13D STS-21D

STUV DAB

ALP. LAT.

STS-35 MEGAS STS-38

PARA-FOR: **STS**

IX-BOLA STS-B1 STS-T14 STS-TV3 STS-TV5 STS-TV6 STS-X5

ALP. ALP. ALP. LAT.

DOM-ERAFE FAC-IFAM SERRALLER TECNESA TECHNOLAR

IX-5 IX-5 IX-5 IX-9

CAYS

PARA-FOR: **STS**

STS-X8

LAT.

PARA-FOR: **STUBLINA**

STB-1 STB-1D

PARA-FOR: **STUMPF**

STF-1 STF-1D

PARA-FOR: **STUV**

STUV-11 STUV-1D

DOM-MLM

Copyright by
Alpacor Alfas S.A.
1978

JMA

112

PARA-FOR: STUV

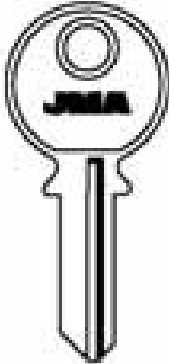

STUV-2

SUREX

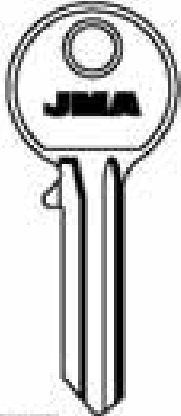

SR-11

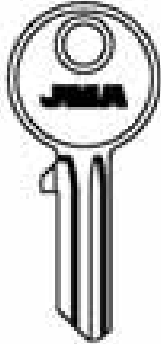

SR-2
ATLAS



SR-3
ATLAS-EUROPE-BATTERY

PARA-FOR:

STUV (D)
SUREX (F)
T-KEY
TAITO (J)
TALLINN (RUS)

PARA-FOR: SUREX



SR-4



SR-5

T-KEY

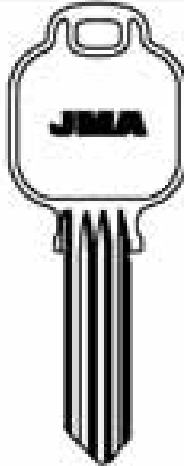

TKY-1

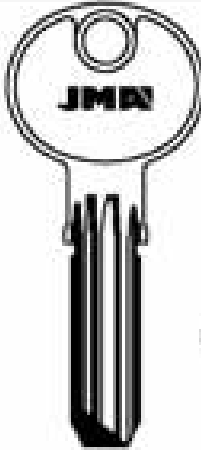

TKY-2
LAT.

PARA-FOR: TAITO

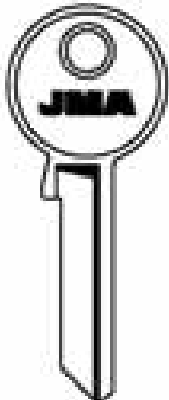

TAI-1

TALLINN

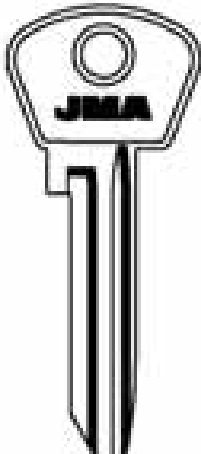

TAL-1



TAL-1D



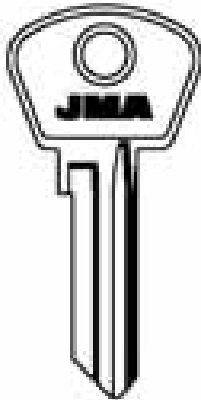

TAL-2



TAL-3





Copyright by
Allegretto Almetti S.A.
2010





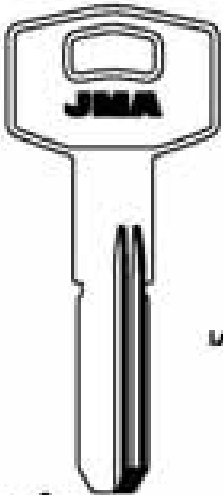

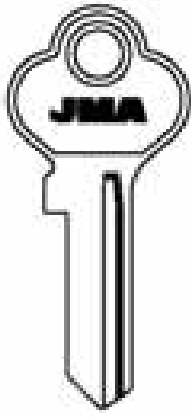
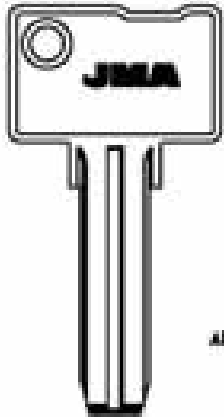

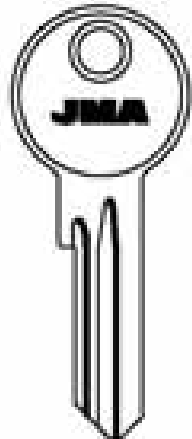

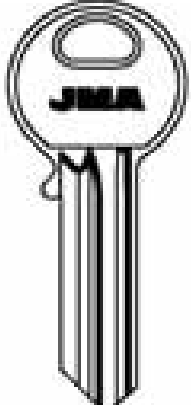





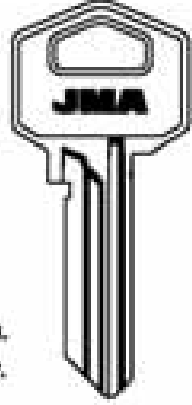

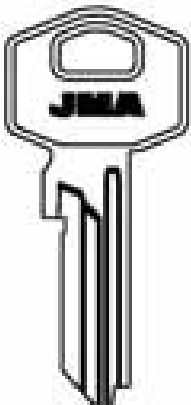

113

PARA-FOR:

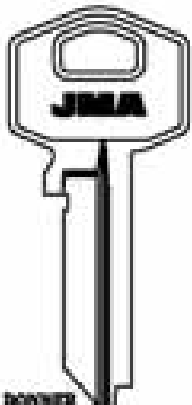
- TARONI (I)
- TAYLOR (USA)
- TECSESA (E)
- TEICOCIL (P)
- TEKA (S)
- TEM (E)
- TESA (E)

<p>PARA: FOR:</p> <p>TARONI</p>  <p>LAT.</p>  <p>TR0-1 TR0-1D</p>	<p>TAYLOR</p>  <p>TAY-1</p>	<p>TECSESA</p>  <p>ALP.</p>  <p>TEC-2</p>	<p>TEICOCIL</p>  <p>TEI-1D</p>
--	---	---	--

<p>PARA: FOR:</p> <p>TEKA</p>  <p>20194 20004</p>  <p>TK-2I TK-2D</p> <p>ARSA-ERMEI-LM</p>	<p>TEM</p>   <p>TEM-135 TEM-D35</p>		 <p>ALU.</p>  <p>TEM-155 TEM-D55</p> <p>CORSA</p>	<p>TESA</p>  <p>ALU. LAT.</p>  <p>TE-1I TE-1D</p>
--	---	--	---	---

<p>PARA: FOR:</p> <p>TESA</p>			
 <p>T</p>  <p>TE-3</p> <p>ME</p>	 <p>T</p>  <p>TE-4</p> <p>IPCO</p>	 <p>DORNER EICO FORTRESS GAINSBOROUGH HARLOC KAYE MASTERCRAFT TAYLOR</p> <p>K AL 9 AL 9 A/2 I AL 9</p>  <p>TE-7D</p>	 <p>AGUEDA BENCO KAYE GAINSBOROUGH GELRAU KEEPE NEWMAN TORRES TE TECHNAL TEICOCIL ORION VENLOCK</p> <ul style="list-style-type: none"> • FOR. • ALU. • COL. • LAT. • NTIC.  <p>TE-8I</p> <p>T... AL 9</p>  <p>TE-8D</p>  <p>TE-8DKT1</p>

Copyright by
Alejandro Allina S.A.
2018

JMA

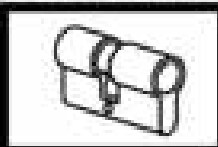

PARA:
FOR:

TESA

PARA-FOR:

TESA (E)

TH (D)

TICINO (I)



PARA:
FOR:

TESA

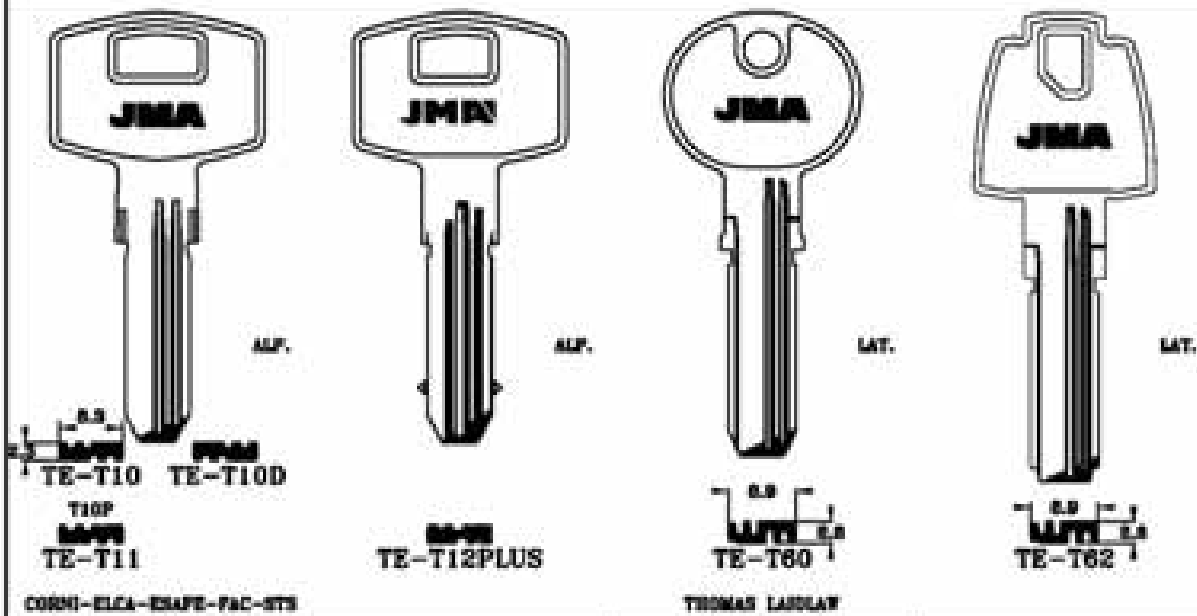

PARA:
FOR:

TESA

TH

TICINO

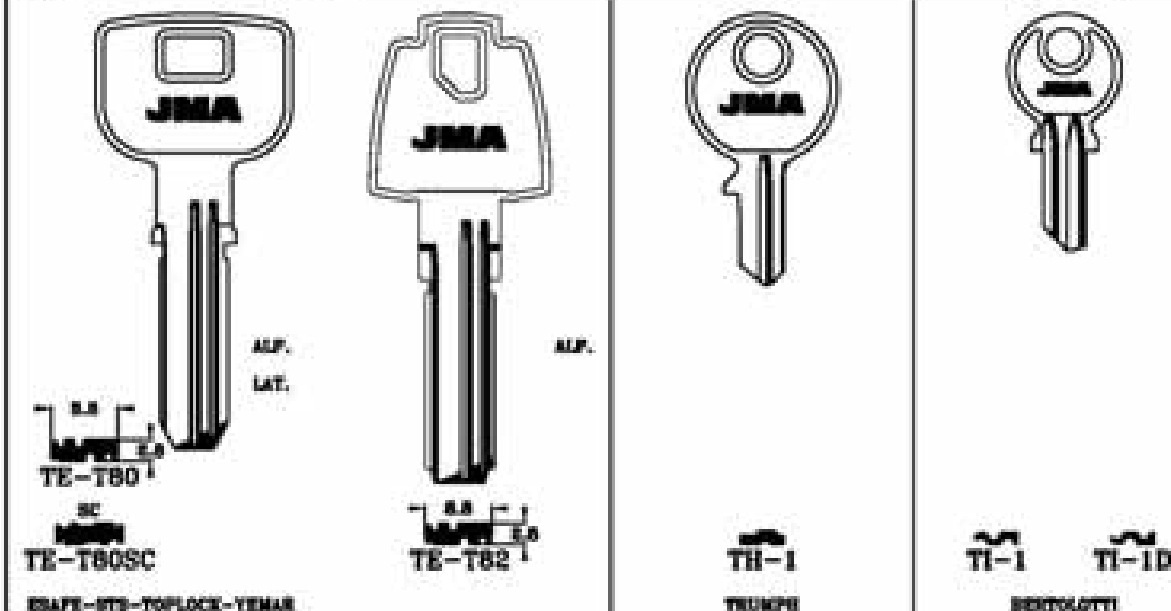

Copyright by
Allegre Altesa S.A.
2010

JMA

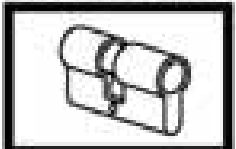







115





PARA-FOR:



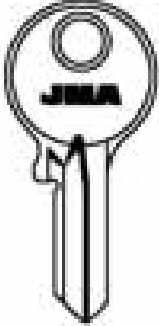
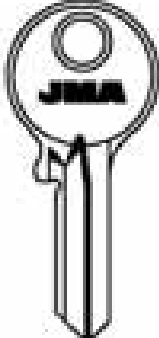
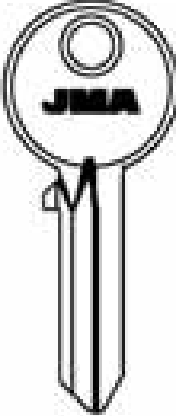
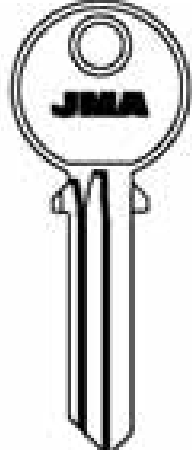

TIFON (RC)

TIGRIS (GB)

TITAN (YU)

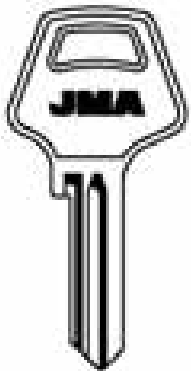
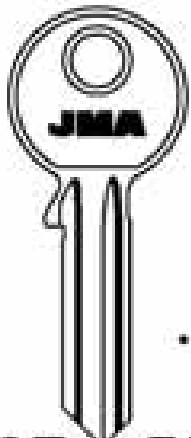
PARA-FOR:	TIFON			
				
				
	TIF-1D	TIF-2D	TIF-15/20	TIF-25D

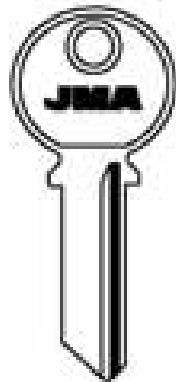
PARA-FOR:	TIFON			TIGRIS
				
				
	TIF-30D	TIF-40D	TIF-50/60	TIG-1D

PARA-FOR:	TITAN			
				
		 		
	TIT-1D	TIT-10	TIT-3	TIT-4
	BILMANN-PAYCAN			FTH-YACETTE

Copyright by
Alejandro Allier S.A.
2018

JMA

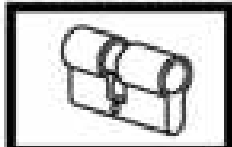

116

PARA:
FOR:

TITAN

PARA-FOR:

TITAN (YU)

TOK WINKHAUS
(D)

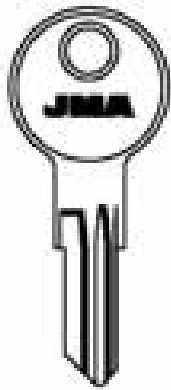

TIT-5



TIT-6

LAT.

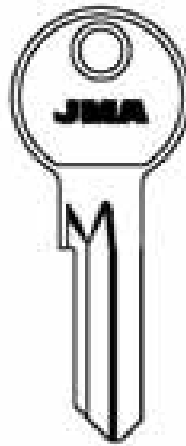

TIT-80

ALL.



TIT-9

TIT-90

LAMA

PARA:
FOR:

TITAN

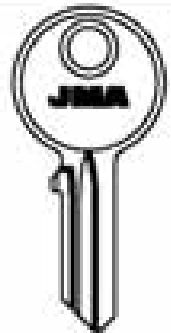

...851-300
TIT-110

TIT-120

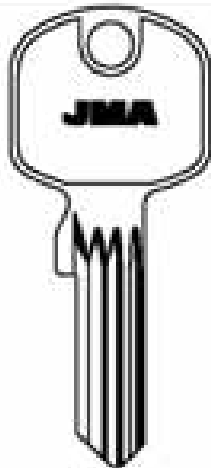

TIT-13

PICARDE

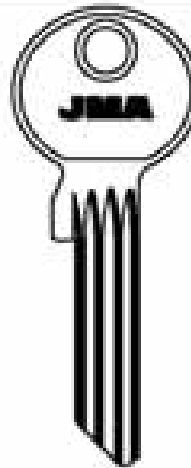

TIT-14

TIT-14D

TIT-15

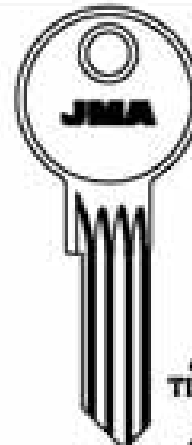

TIT-160

TIT-160

TIT-150

PICARDE

PARA:
FOR: TITAN

TOK WINKHAUS



TIT-17

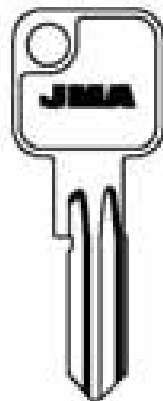

TOK-2

TOK-2D

TRELOCK



TOK-3

TOK-3D

TRELOCK

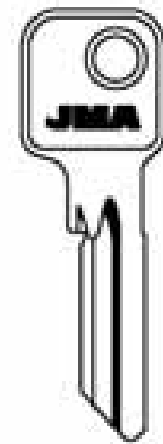

TOK-4D

TRELOCK

Copyright by
Algebra Altius S.A.
2010

JMA

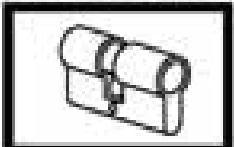

117

PARA-FOR:

PARA-FOR:

TOK WINKHAUS

TOK WINKHAUS (D)

TOMKS (RUS)

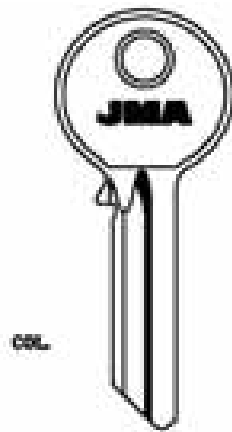

COL.

N/T/L

0 AL 8

TOK-5D

COMBA-SERIAL
TRELLOCK-YACHETTE

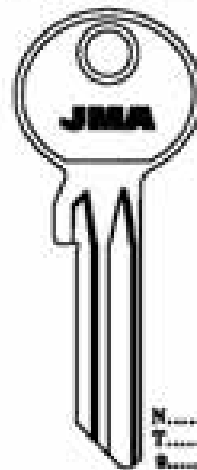

TOK-6

N.....
T.....
S.....
D.....
0 AL 8

TOK-6D

TOK-27

TOK-28

TOK-25

PARA-FOR:

TOK WINKHAUS

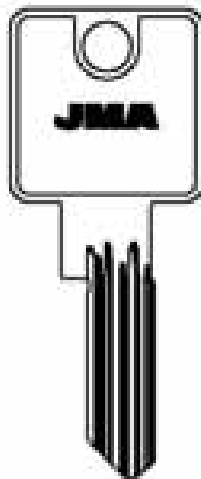

EPAS
BIF-1

TOK-32

TOK-34D

ELFF
TOK-23

TOK-28D

TOK-15

EPAL
TOK-16D

EPAL
TOK-13D

EPYU
TOK-14D

EPAN
TOK-11

EPUS
TOK-12

EPDA
TOK-9

EPDF
TOK-10D

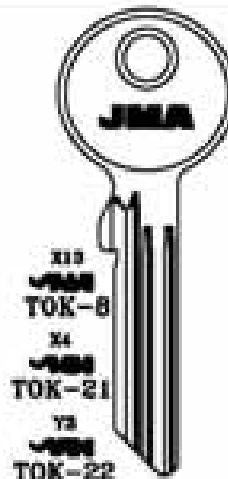

X13
TOK-8

X4
TOK-21

Y3
TOK-22

Y14
TOK-24

LAT.

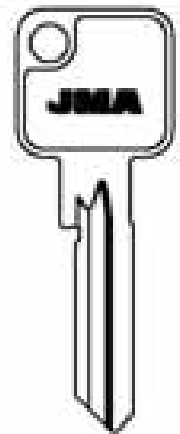

TOK-17D

FICRET-EPFAR

TRELLOCK

PARA-FOR:

TOK WINKHAUS

TOMSK



TOK-18

TOK-19

TOK-20



TOK-30

TOK-29D

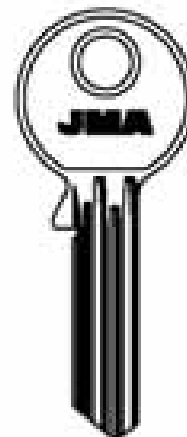

TOK-31

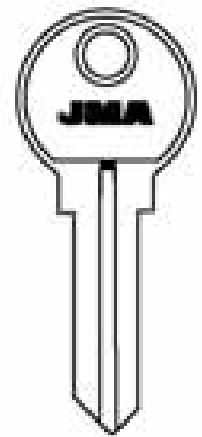

TOM-1D

Copyright by
Magistra Alfas S.A.
2010

JMA



118

PARA: TOP
FOR:

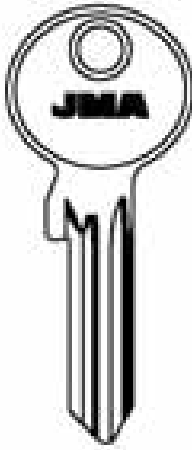

TOP-1
ABUS-NOVA

TOVER

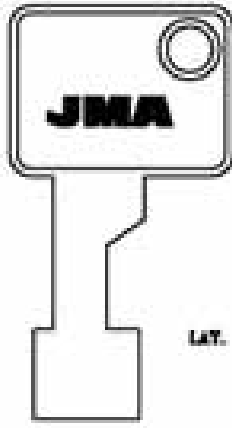

TOV-1
TIBOCCEL

LAT.

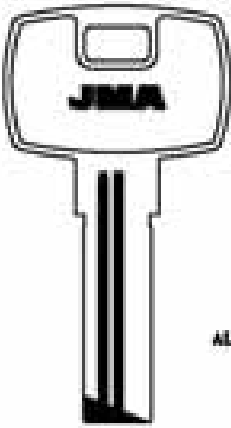

TOV-2

ALP.

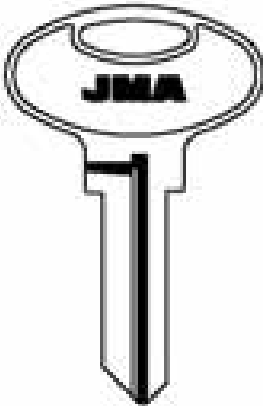

TOV-3



PARA-FOR:

TOP (D)
TOVER (E)
TRAVEX (PE)
TRELOCK (D)
TRI-CIRCLE (RC)

PARA: TOVER
FOR:

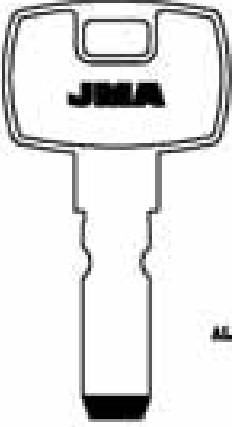

TOV-4
TROMER

ALP.



TOV-5

ALP.

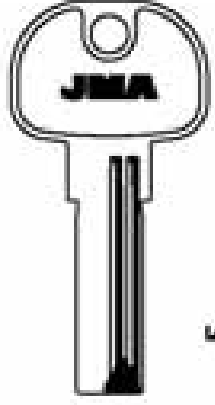





TOV-6

LAT.



TOV-7

LAT.

PARA: TRAVEX
FOR:

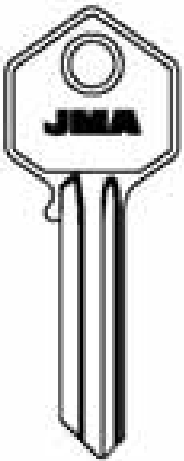

TRV-1



TRV-1D

TRELOCK



TRL-1.P



TRI-CIRCLE





TRI-11





TRI-1D

TRI-21 **TRI-22**



TRI-31 **TRI-3D**

TRI-41 **TRI-42**

MARK

Copyright by
Algebra Almas S.A.
2010

119

PARA-FOR:

**TRI-CIRCLE
(RC)**

TRI STAR (RC)

TRIO-VING (N)

PARA-FOR: **TRI-CIRCLE**

4A TRI-51 4C TRI-5D
3A TRI-71 3C TRI-7D
3B TRI-81 3D TRI-8D
2A TRI-91 2C TRI-9D
1A TRI-111 1C TRI-11D
1B TRI-121 1D TRI-12D
TRI-13
TRI-14

ELEPHANT

PARA-FOR: **TRI-CIRCLE**

TRI-15 TRI-16 TRI-17D TRI-18 TRI-18D

PARA-FOR: **TRI-CIRCLE**

TRI-19 TRI-19D TRI-20

TRI STAR

TST-1

TRIO-VING

TV-10
TV-2D
TV-13

Copyright by
Algebra Altesa S.A.
2018

JMA



120

PARA-FOR:

UCEM (E)

ULIANOVSK (RUS)

PARA-FOR: **UCEM**

• ALL.
• LAT.
• PSB.

• MTC (V)
• ALL.
• LAT.
• PSB.

5-L • UCEM-11 UCEM-1D UCEM-21 UCEM-2D UCEM-3 UCEM-12 •

CD-ENLOQ-QCM-87V CD-88

PARA-FOR: **UCEM**

ALP. LAT.

DEBEAUBAIN
ESCAPE
ISSO
NO
YEMAR

UCEM-4I UCEM-5I UCEM-5D UCEM-7I UCEM-7D UCEM-8D

STIQAN PENT

PARA-FOR: **UCEM**

ALP. ALP. LAT.

DEBEAUBAIN
ESCAPE
ISSO
NO
YEMAR

UCEM-8D.P UCEM-13D UCEM-17D

PH

ULIANOVSK





UL-1





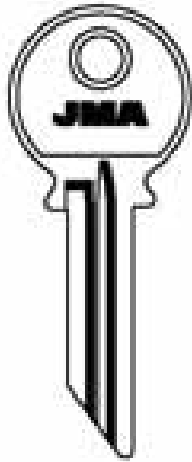
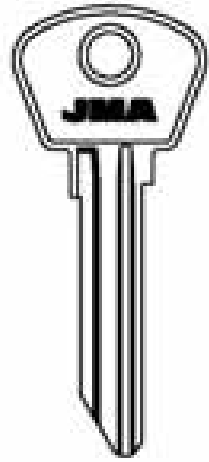
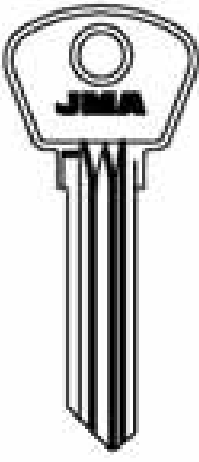
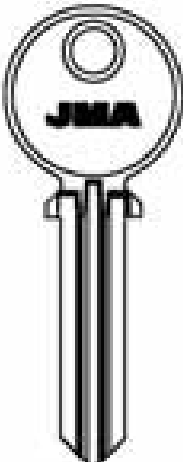



Copyright by
Alejandro Allier S.A.
1818

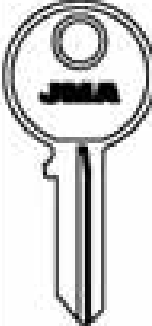

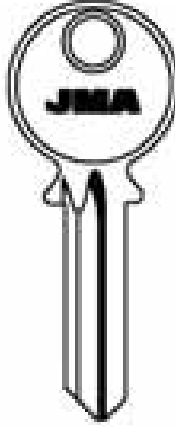

JMA

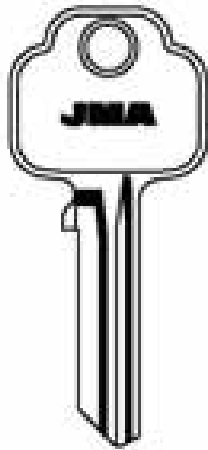

122

PARA-FOR:	ULIANOVSK		UMF	PARA-FOR: ULIANOVSK (RUS) UMF (P) UNION (GB)
	  			
	 UL-2D	 UL-3	 UL-4	 UMF-1

PARA-FOR:	UNION				
		 			
	<p>NRA FFE...1-100 FGA...1-100 FL...251-300 NGA...51-90 YFE...1-75 FGD...1-75 FG...1-90 KF...1-90 GAE...1-75</p> <p>FF... 600-700</p> <p>UN-FFE</p> <p>MC...1-40 MRA...201-240 MRN...1-64 MRN...201-250 MRN...251-300</p> <p>UN-MRN</p> <p>FL... 701-875</p> <p>UN-FR</p> <p>FL... 876-955</p> <p>UN-IFS</p> <p>FL... 501-600</p> <p>UN-44</p> <p>GN... 911-950</p> <p>UN-44D</p> <p>HGN...1-64 UN-NG</p> <p>K303A UN-5D</p> <p>K3006 UN-6D</p> <p><small>KEYS: UN-LAYD-FEED-CLLGR-UN-CLLGR-LAND UN-75-80-80000-81000</small></p>	 UN-3	 UN-FP	 UN-3	 UN-FR

PARA-FOR:	UNION				
		 UN-71	 UN-7D	 UN-7D	
	<p>900 UN-121</p> <p>974 UN-131</p> <p>975 UN-141</p> <p>976 UN-151</p> <p>977 UN-161</p> <p>978 UN-171</p> <p>979 UN-181</p>	<p>951 UN-191</p> <p>980 UN-201</p> <p>983 UN-211</p> <p>984 UN-221</p> <p>985 UN-231</p> <p>986 UN-241</p> <p>987 UN-251</p> <p>988 UN-261</p> <p>989 UN-271</p>	<p>914 UN-13D</p> <p>915 UN-14D</p> <p>916 UN-15D</p> <p>917 UN-16D</p> <p>918 UN-17D</p> <p>919 UN-18D</p>	<p>901 UN-19D</p> <p>902 UN-20D</p> <p>903 UN-21D</p> <p>904 UN-22D</p> <p>905 UN-23D</p> <p>906 UN-24D</p> <p>907 UN-25D</p> <p>908 UN-26D</p> <p>909 UN-27D</p>	

Copyright by
Allegre Almas S.A.
2018

JMA



123

PARA-FOR:

UNION (GB)

UNIVERSAL

PARA-FOR: **UNION**

863 UN-281	861 UN-351	814 UN-290	801 UN-35D
874 UN-291	862 UN-361	815 UN-300	802 UN-36D
876 UN-301	863 UN-371	816 UN-310	803 UN-37D
878 UN-311	864 UN-381	817 UN-320	804 UN-38D
877 UN-321	865 UN-391	818 UN-330	805 UN-39D
878 UN-331	866 UN-401	819 UN-340	806 UN-40D
879 UN-341	867 UN-411		807 UN-41D
	868 UN-421		808 UN-42D
	869 UN-431		809 UN-43D

PARA-FOR: **UNION**

UN-01 UN-9D UN-101 UN-10D UN-45D UN-48D

PARA-FOR: **UNION**

UN-FK UN-FS

UNIVERSAL

TX-1 U-11 U-1D

Copyright by
Alpacma Alfas S.A.
1818

JMA

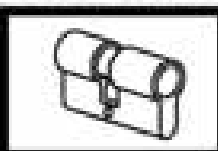

124

PARA:
FOR:

UNIVERSAL

PARA-FOR:

UNIVERSAL

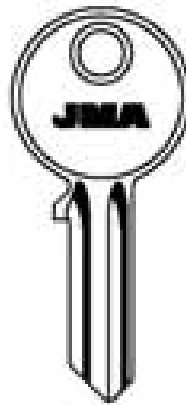
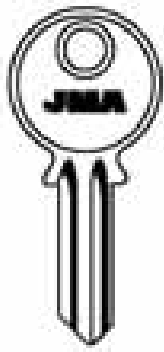

ALLI.



U-2I

U-2D

U-3I

U-3D

U-4I

U-4D

U-4AI

U-4AD

TECNO

PARA:
FOR:

UNIVERSAL

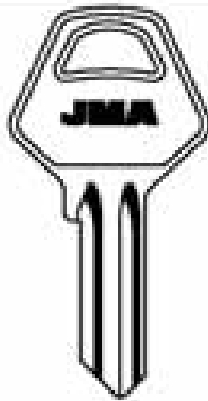

ALLI.
+ FIBL.
COL.
WTC.(9-U)



U-4TI

U-4TD

U-4TI

U-4TD

U-5I

U-5D

U-5AI

U-5AD

EMPE-SIL

PARA:
FOR:

UNIVERSAL

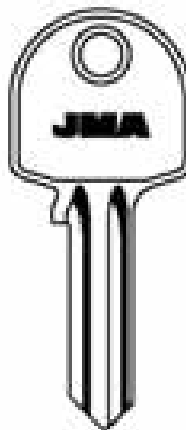
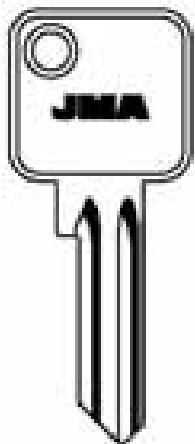

U-5BI

U-5BD

U-5CI

U-5CD

U-5DI

U-5DD

U-5EI

U-5ED

Copyright by
Allegre Almas S.A.
2018

JMA

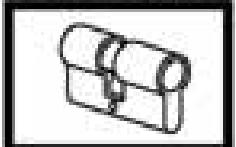

125

PARA-FOR:

UNIVERSAL

PARA-FOR:

UNIVERSAL

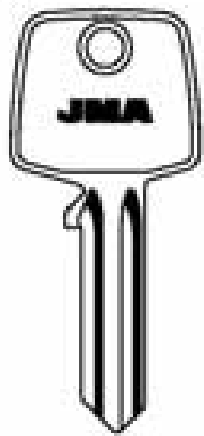

U-5FI

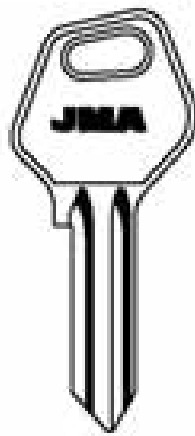

U-5FD



U-5JI

U-5JD

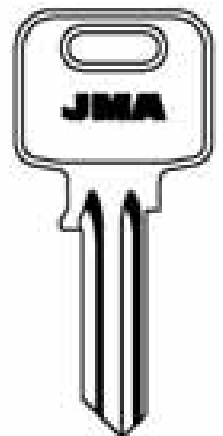

U-5KI

U-5KD

U-5MI

U-5MD

PARA-FOR:

UNIVERSAL

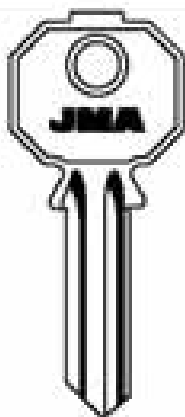

U-5PI

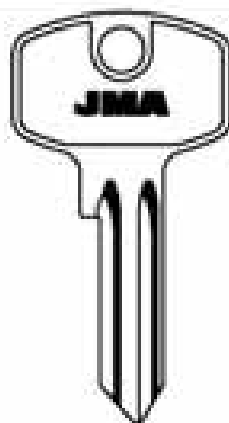

U-5PD

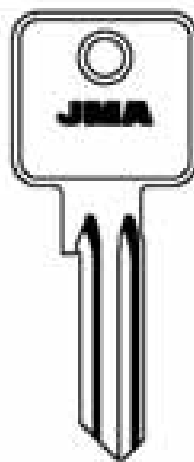

U-5QI

U-5QD

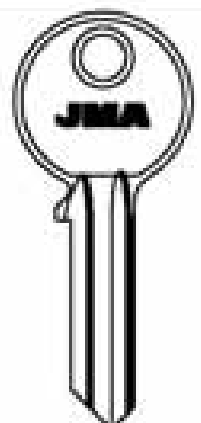

U-5SI

U-5SD

U-5SP

U-5DSP

PARA-FOR:

UNIVERSAL

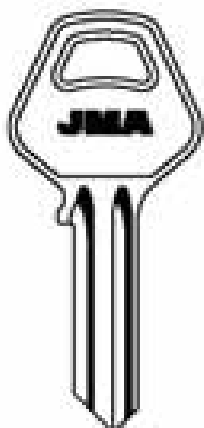

U-5TI

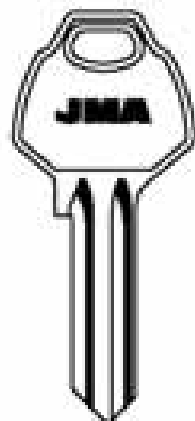

U-5TD

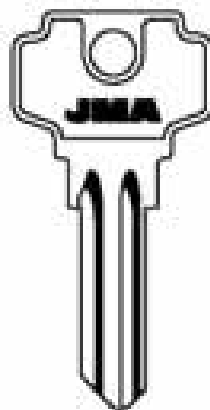

U-5VI

U-5VD

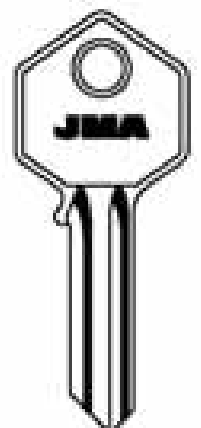

U-5XI

U-5XD

U-5YI

U-5YD

Copyright by
Alfonso Altamir S.A.
1978

JMA

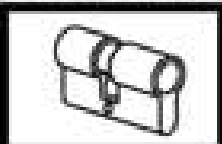

126

PARA:
FOR:

UNIVERSAL

PARA-FOR:

UNIVERSAL

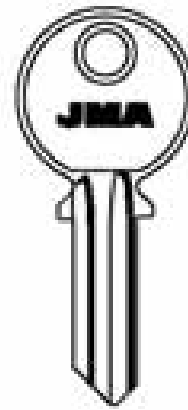
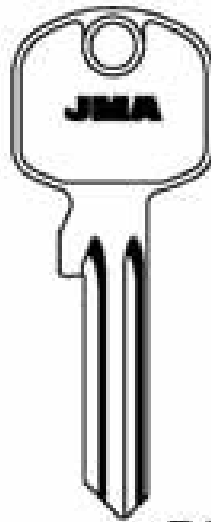
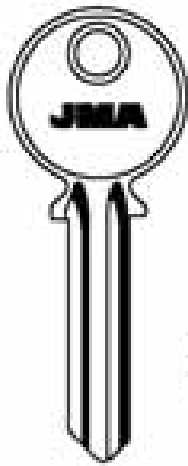

COL.
ALD.

U-61

U-6D

U-68D

U-6GD

U-7

U-7D

PARA:
FOR:

UNIVERSAL

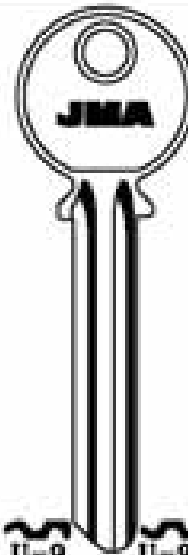
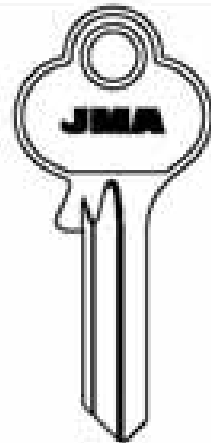
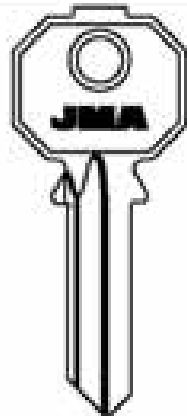
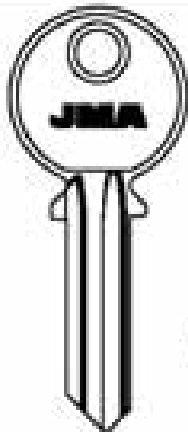

LAT.

U-8

U-8D

U-8PD

U-8TD

U-9

U-9D

TYO-18

PARA:
FOR:

UNIVERSAL

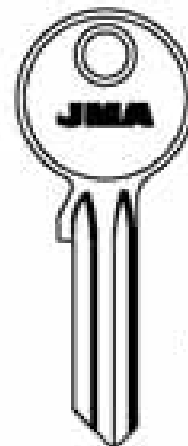
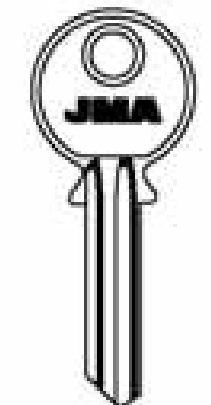
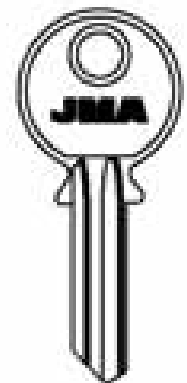
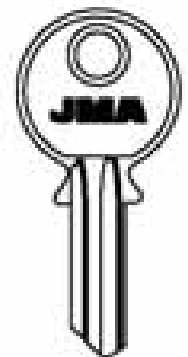

MTC.

U-101

U-10D

U-131

U-13D

U-141

U-14D

U-15

U-15D

TYO-20

TYO-20

Copyright by
Algebra Altesa S.A.
2018

JMA

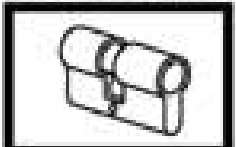

127

PARA-FOR:

UNIVERSAL

URBIS (R)

URKO (E)

PARA-FOR: UNIVERSAL

• FBI.

U-15GI U-15GD U-16 U-16D U-17 U-17D U-18D

TVG-45 CISA 1000

PARA-FOR: UNIVERSAL

U-19 U-19D U-21 U-21D U-22 U-22D U-25 U-25D

PARA-FOR: URBIS

LAT.

URB-1 URB-1D URB-2 URB-3D URB-4D

BANK BEXULIC

PARA-FOR: URKO





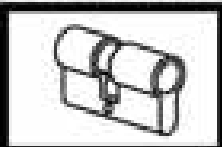

URKO-11 URKO-1D URKO-21 URKO-2D



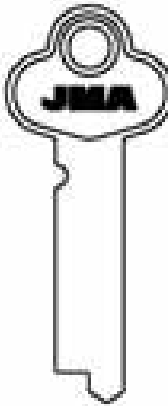
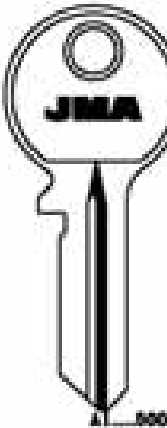







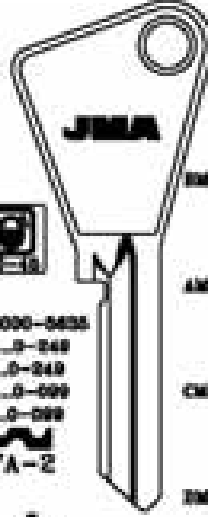

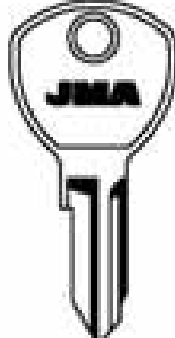



Copyright by
Alfonso Altamir S.A.
1978











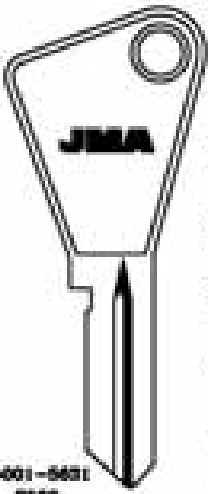













JMA



128

PARA: FOR:	URKO	VACHETTE	PARA-FOR: URKO (E) VACHETTE (F)
			
	  URKO-31 URKO-3D	 URKO-4	 VA-1  VA-75D <small>SAU-FONTAINE-REMA-LAPERCHIE METALUX-MODERN-STREMLER</small>

PARA: FOR:	VACHETTE			
				
 <small>A...8000-8433 AY...9-848 Y...9-849 AR...9-899 E...9-899</small>  VA-2  VA-5	 <small>EM...870-894</small> VA-19  <small>AM...870-894</small> VA-20  <small>CM...870-894</small> VA-21  <small>EM...870-894</small> VA-22	 <small>AM...870-894 EM...870-894 CM...870-894 DM...870-894</small> VA-23  <small>...I AL 8 AL 8 E...8001-8199 ...8001-8199</small> VA-31	 VA-3 <small>...I AL 8 AL 8 E...8001-8199 ...8001-8199</small>  VA-4  VA-131	 <small>D...428 D...9-821</small> VA-4D  <small>D...428 D...9-828</small> VA-13D
	ISSO-BLIT	ATAL-TINCO		

PARA: FOR:	VACHETTE		
			
<small>AL...8001-8431 UL...1-8000 E...I AL 8 AL 8</small>  VA-BD	 <small>RA-KA</small> VA-RA  <small>RB-KB</small> VA-RB  <small>RC-KC</small> VA-RC  <small>RE-KE</small> VA-RE  <small>RF-KF</small> VA-RF  <small>RG-KG</small> VA-RG  <small>RJ-KJ</small> VA-RJ  <small>KK-KK</small> VA-ROK  <small>EL-EL</small> VA-RL	 <small>RD</small> VA-RD  <small>RDH</small> VA-RDH  <small>RDM</small> VA-RDM  <small>RHM</small> VA-RHM  <small>RM</small> VA-RM  <small>RK</small> VA-RK  <small>DHP</small> VA-DHP	 <small>LD</small> VA-LD  <small>LA-AK</small> VA-LA  <small>LA-BK</small> VA-LB  <small>LC-CK</small> VA-LC  <small>LE-EK</small> VA-LE  <small>LF-FK</small> VA-LF  <small>LG-GK</small> VA-LG

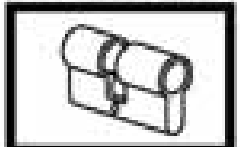
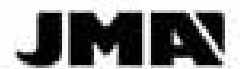

Copyright by
Alejandro Allina S.A.
2018



PARA-FOR:





VACHETTE (F)

PARA-FOR: **VACHETTE**

 **VA-90**
 **VA-120**
 **VA-140**











BUSA **TRELOCK**

PARA-FOR: **VACHETTE**

 **VA-15**
 **VA-241**  **VA-24D**
 **VA-25**
 **VA-26**

ALP.
RADIAL

PARA-FOR: **VACHETTE**

 **VA-27**
 **VA-28**
 **VA-56**
 **VA-29**
 **VA-35**
 **VA-29D**
 **VA-35D**
 **VA-30**
 **VA-62**
 **VA-62D**

ALP.
BAD-JU **VINCO**

Copyright by
 Alejandro Allina S.A.
 2018

JMA

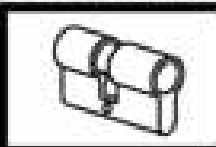

130

PARA:
FOR:

VACHETTE

PARA-FOR:

VACHETTE (F)



ALP
VA-31D

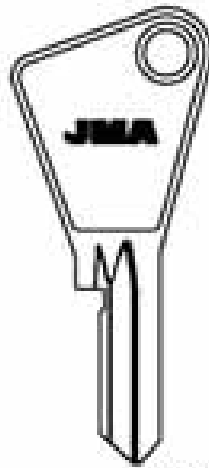

ALP
VA-32D

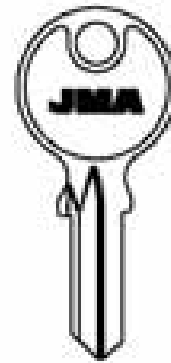

VA-33D

PARA:
FOR:

VACHETTE

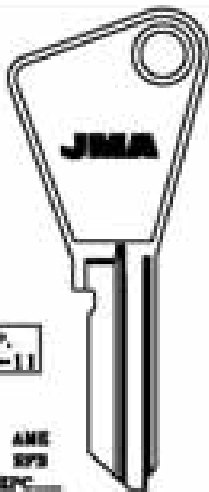

ALP
VA-11

ALP
VA-11

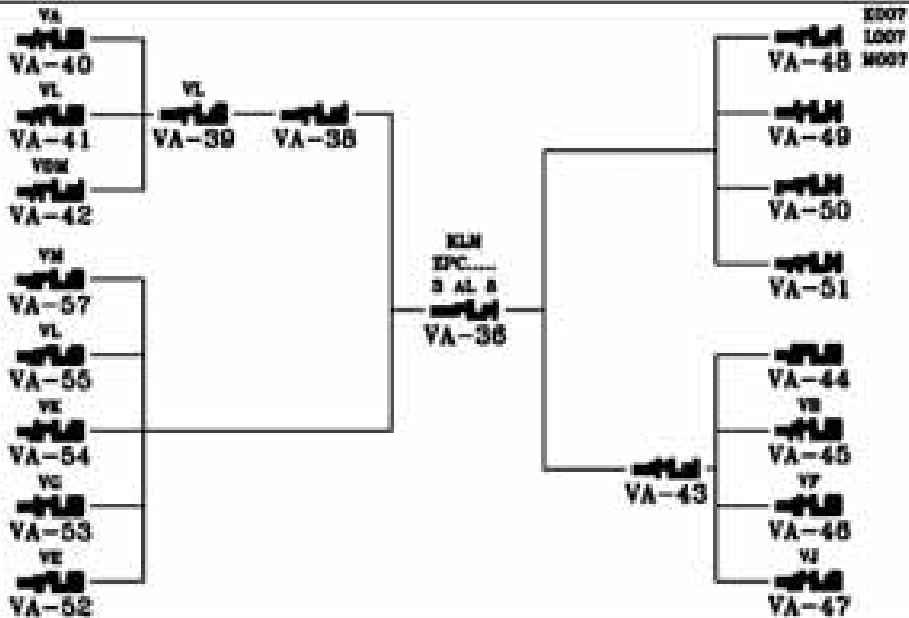

PARA:
FOR:

VACHETTE

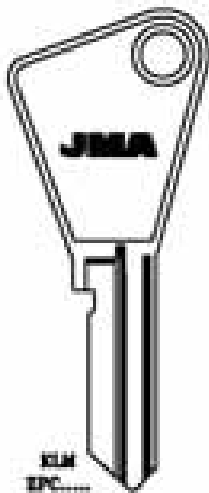

ALP
VA-37

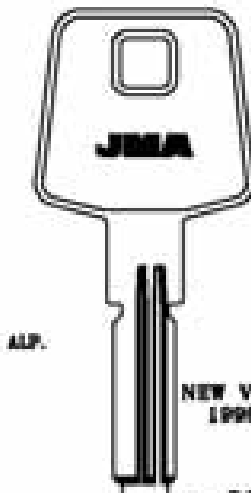

ALP
NEW VER.
1990
VA-58

RADIAL



VA-59



VA-60

SANPUC

Copyright by
Alejandro Allier S.A.
2010

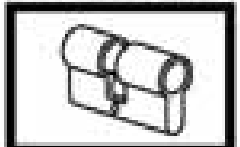
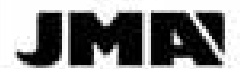

131

PARA-FOR:

VACHETTE (F)

VARIOS

VBH (D)

VEGA (F)

VENDI (RO)

PARA-FOR: VACHETTE

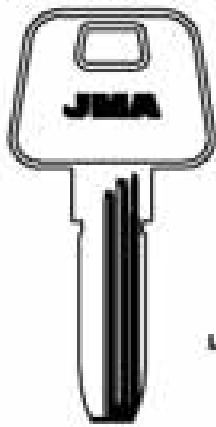

LAT.

VARIOS

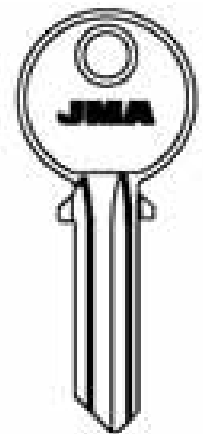
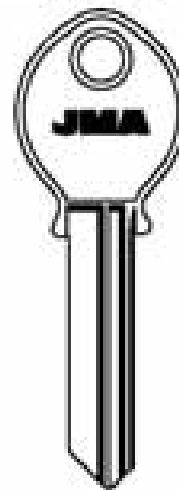
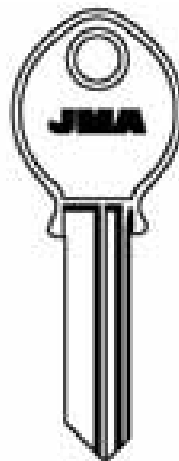

FAC

PARA-FOR:

VARIOS

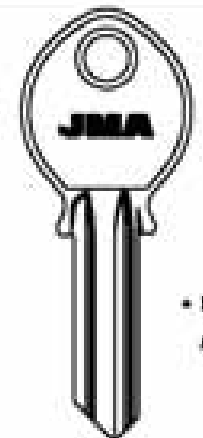
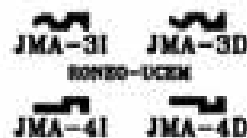
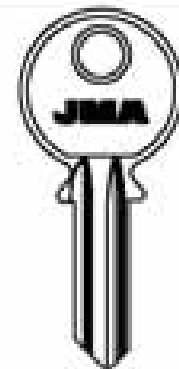
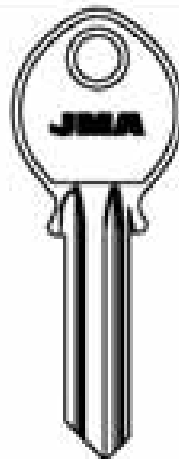
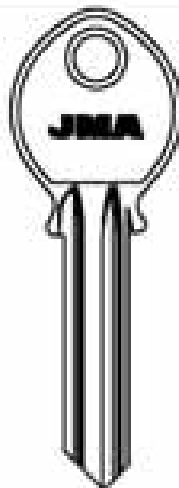

+ LAT.
ALL.

PARA-FOR:

VBH

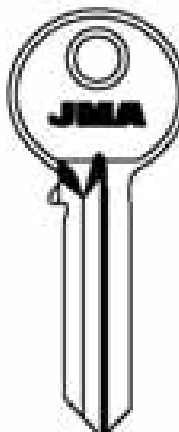
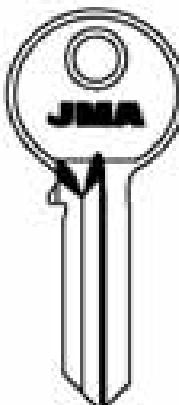

VEGA

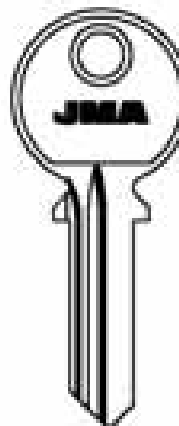

VENDI

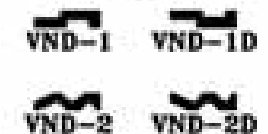
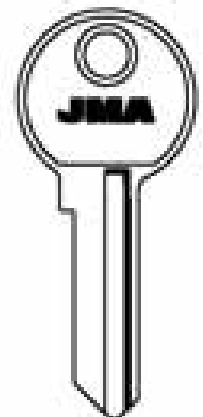





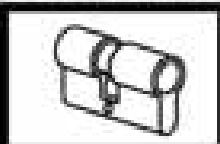

VACHETTE



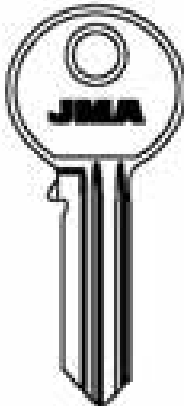

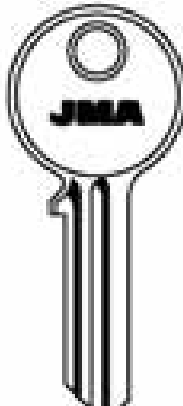
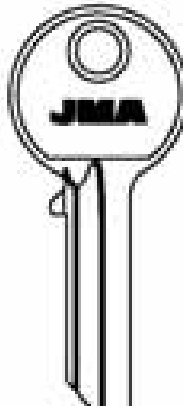



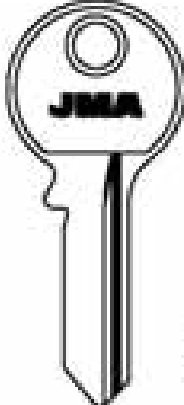
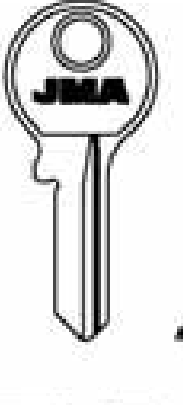
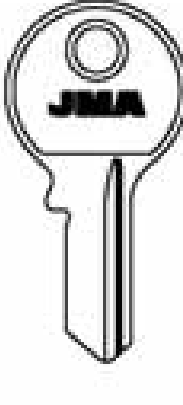

Copyright by
Alphonse Allier S.A.
1818







JMA

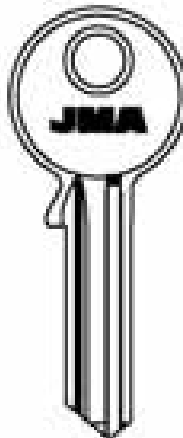

132

PARA: FOR:	VENDI	VGF VILLATORE		VING	PARA-FOR:
					VENDI (RO)
					VGF VILLATORE (I)
	VND-3	VGF-41	VGF-40	VGF-51	VGF-5D
					VING (N)
					VIRO (I)

PARA: FOR:	VIRO					
						
	ALL. LAT.					
						
	0 AL 8		0 AL 8	0 AL 8		
	VI-11		VI-12	VI-21	VI-2D	VI-41
				ARIS-BERAM-ROYAL-TEMA		APT

PARA: FOR:	VIRO			
				
				
	0 AL 8			0 AL 7
	VI-41P	VI-4DP		VI-6D
	ARIS-ROYAL	APT	ARIS-BURC	VI-8
				SPECIAL
				VI-8D

PARA-FOR:
VENDI (RO)
VGF VILLATORE (I)
VING (N)
VIRO (I)

Copyright by
 Alejandro Allina S.A.
 2018



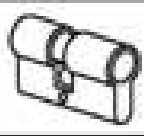

JMA





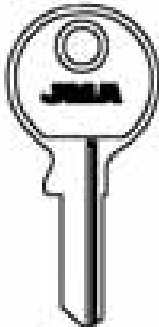

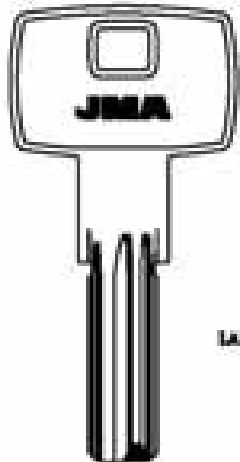

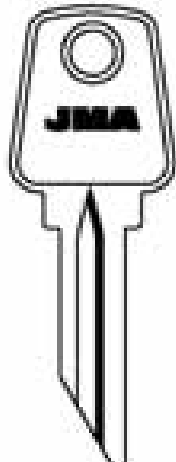

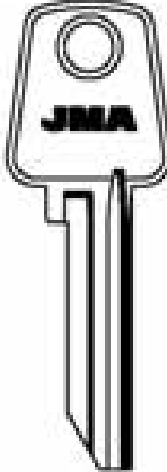
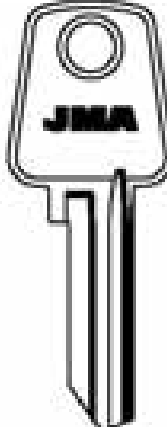
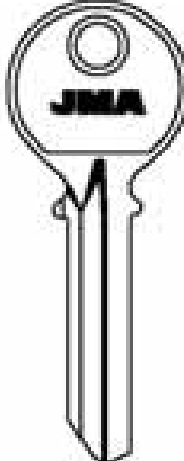



133

PARA-FOR:

- VIRO (I)**
- VOLGOGRAD (RUS)**
- VOLKOVYSK (RUS)**
- WALLY (RC)**
- WALRUS (RC)**

PARA-FOR:	VIRO		VOLGOGRAD
			
			
	VI-10	VI-11 VI-11D	VI-14 EURO-PRO

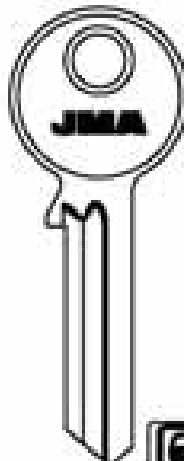
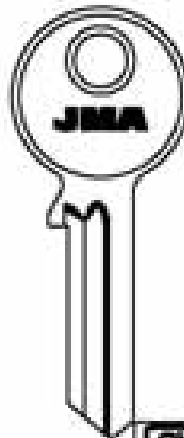
PARA-FOR:	VOLKOVYSK	WALLY
		
		
	VLK-1	VLK-2
		
	WA-1D	WA-4I WA-4D

PARA-FOR:	WALLY	WALRUS
		
		
	WA-5I	WA-5IP
		
	WA-5D	WA-5DP
		
		
	WAL-1D	WAL-2D

Copyright by
Alpacare Allmax S.A.
2019

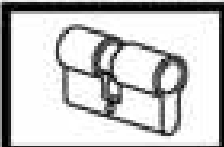

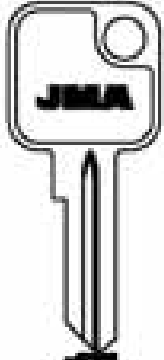
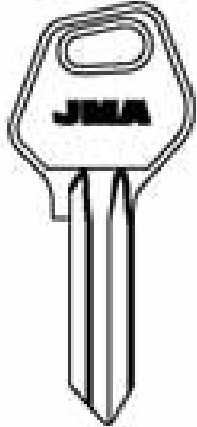
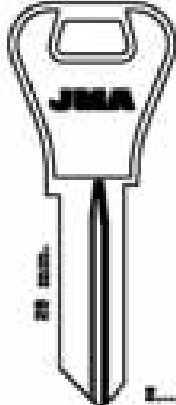
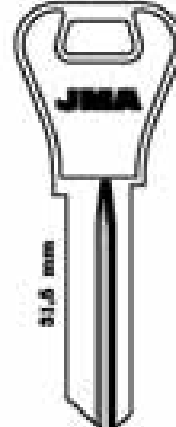
PARA-FOR: WEBER	WEBSTER	WEISER	
 <p>JMA</p> <p>WEB-1</p> <p>WEB-2</p> <p>WEB-3</p> <p>WECO</p>	 <p>JMA</p> <p>WBS-1</p>	 <p>JMA</p> <p>31,5 mm</p> <p>E... AL 9 ... AL 9</p> <p>WEI-1</p> <p>... AL 9 ... AL 9</p> <p>WEI-6</p> <p>BAVE</p>	 <p>JMA</p> <p>31,5 mm</p> <p>E... AL 9 ... AL 9</p> <p>WEI-2</p> <p>FALCON-PHET</p>

PARA-FOR:

WEBER (D)

WEBSTER (GB)





WEISER (USA)

WELKA (D)

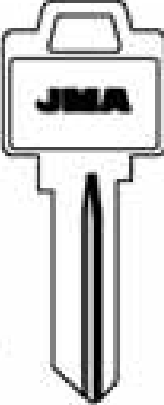
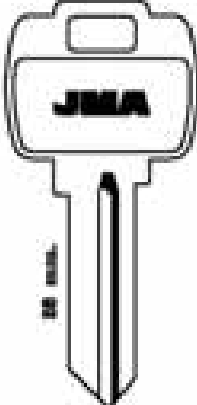
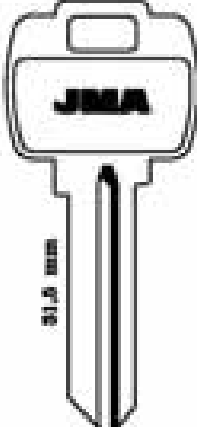
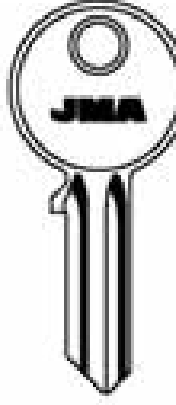
WESLOCK (USA)

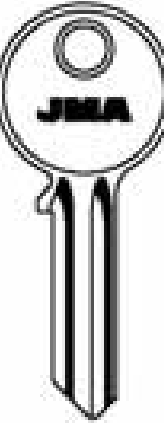
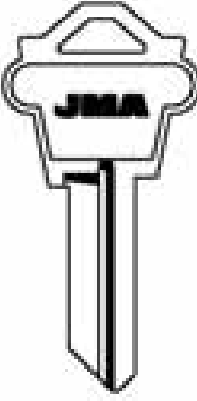
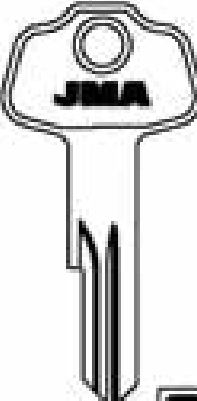
WEST LOCK (USA)

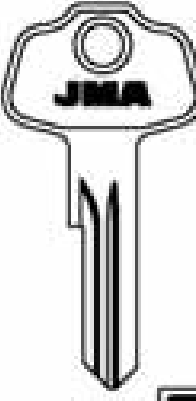
PARA-FOR:	WEISER		WELKA
 <p>JMA</p> <p>ALL</p> <p>E... AL 9 ... AL 9</p> <p>WEI-3</p> <p>IDEAL SECURITY</p>	 <p>JMA</p> <p>31,5 mm</p> <p>E... AL 9 ... AL 9</p> <p>WEI-4</p> <p>FALCON</p>	 <p>JMA</p> <p>31,5 mm</p> <p>E... AL 9 ... AL 9</p> <p>WEI-5</p> <p>FALCON</p>	 <p>JMA</p> <p>... AL 9</p> <p>WE-41 WE-40</p>

PARA-FOR:	WESLOCK	WEST LOCK	
 <p>JMA</p> <p>... AL 9</p> <p>WE-51 WE-50</p>	 <p>JMA</p> <p>WES-10</p>	 <p>JMA</p>  <p>... AL 9</p> <p>WST-10</p>	 <p>JMA</p>  <p>... AL 9</p> <p>WST-20</p>

Copyright by
 Alejandro Altamir S.A.
 2018

JMA

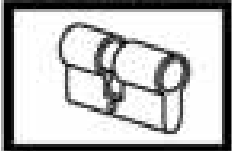

135

PARA-FOR:

WILKA (D)

WINKHAUS (D)

PARA-FOR: **WILKA**

ALL. MYC.

WIL-1D

WIL-7

WIL-2D

WIL-3D

WIL-4D

WIL-7 **WIL-2D** **WIL-3D** **WIL-4D**
JOKE-WIGRO OFF-DIB JOKE-WIGRO

PARA-FOR: **WILKA**

LAT. •

WIL-5 **WIL-5D**

WIL-8

WIL-9

WIL-18

WIL-19D

WIL-14 **WIL-15**

WIL-12 **WIL-13**

WIL-10 **WIL-11**

PARA-FOR: **WILKA**

WIL-16

WIL-17D

WIL-20

WIL-22

REHE 3000

WINKHAUS

LAT. ALP.

WIN-11 **WIN-1D**

WIN-2D

WIN-3D

ALDE

Copyright by
Alpacma Altea S.A.
1978

JMA

136

PARA:
FOR:

WINKHAUS



ALP.



ALP.

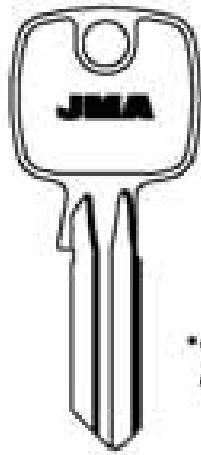

+ALP.
ACE.

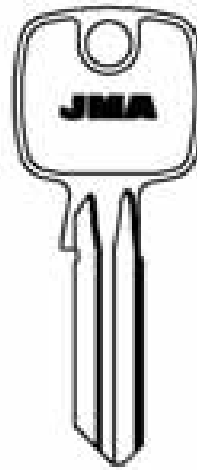
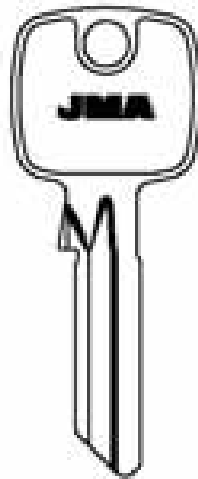

PARA-FOR:

WINKHAUS
(D)

WIREROPE
(HK)

WMS (GB)

YALE
(D-GB-USA)

PARA:
FOR: WIREROPE

WMS

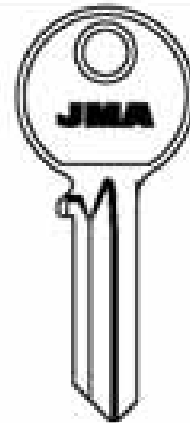
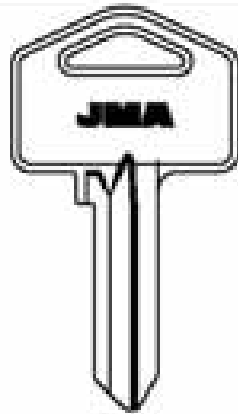
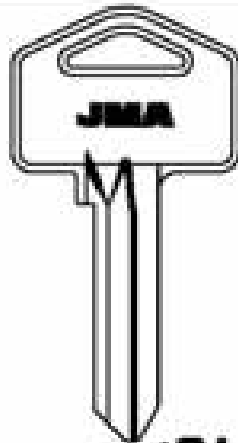
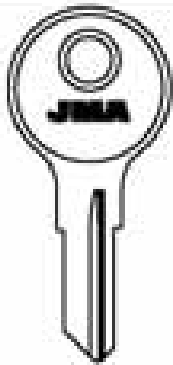

PARA:
FOR: WMS

YALE

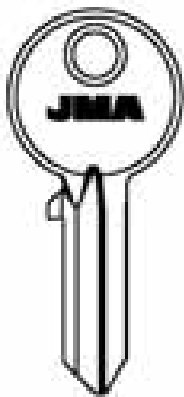

LR-TITUS

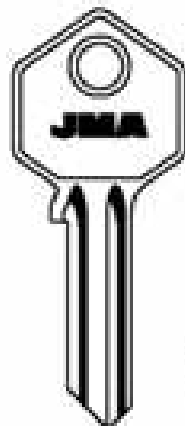

ALL.
COL.



...D AL P



WALE

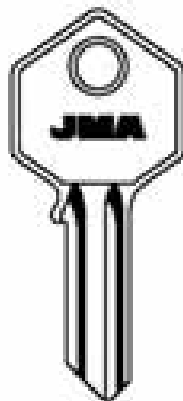

COL.
ALL.



...D AL P

WALE

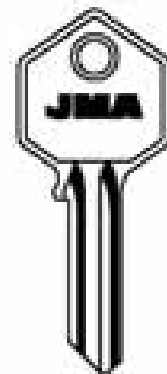

WALE

Copyright by
Alpacare Almas S.A.
2010

JMA

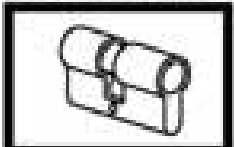

137

PARA-FOR:

**YALE
(D-GB-USA)**

PARA-FOR: **YALE**

ALL. COL.

100 1000 CARAT LAREDO BOC WOC

R...1-150
 YA-71 YA-7D

R...1-1000
 R...1-4000
 R...1-500
 YA-16D

R...1-900
 YA-81 YA-8D

YA-51 YA-5D
 YA-61 YA-6D
 YA-91

NIGNON

DES-FCO

PARA-FOR: **YALE**

ALL.

100 1000 CARAT LAREDO BOC WOC

YA-10 YA-10D
 YA-111 YA-11D
 YA-121 YA-12D
 YA-131 YA-13D

YA-101 YA-10D
 YA-11 YA-11D
 YA-12 YA-12D
 YA-13 YA-13D

DES

PARA-FOR: **YALE**

ALL. COL.

YA-141 YA-14D
 YA-151 YA-15D
 YA-171 YA-17D
 YA-181 YA-18D
 YA-191 YA-19D
 YA-211 YA-21D
 YA-221 YA-22D

YA-141 YA-14D
 YA-151 YA-15D
 YA-171 YA-17D
 YA-181 YA-18D
 YA-191 YA-19D
 YA-211 YA-21D
 YA-221 YA-22D

Copyright by
Allegre Altes S.A.
1978

JMA

138

PARA:
FOR:

YALE

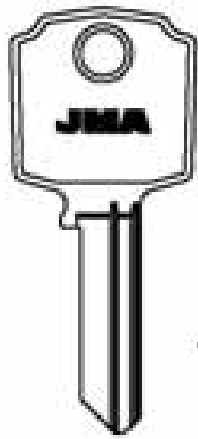

YA-23

ALP. ALU.
CCL.
+ PSL.

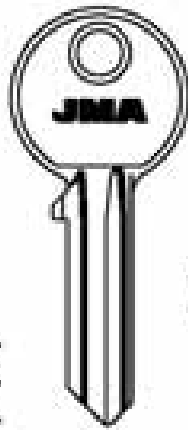

YA-24I • YA-24D

GB

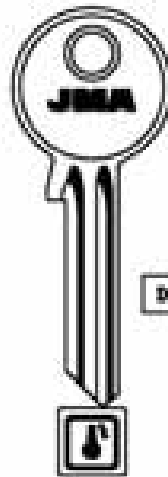

YA-25I YA-25D

D GB

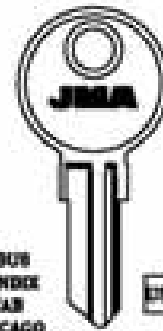

ABUS
BENDIX
CAB

CHICAGO
COLE HERSEE

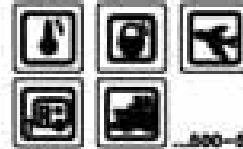

DEA GB

YA-27 YA-27D

PARA-FOR:

YALE
(D-GB-USA)

PARA:
FOR:

YALE



YA-28 YA-28D

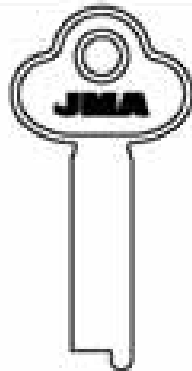

YA-30

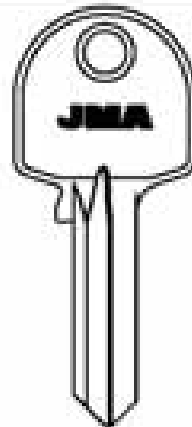

YA-31D

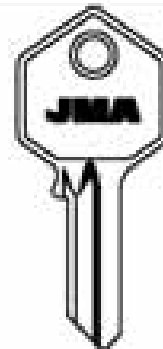

YA-33D

YA-53 YA-53D

PARA:
FOR:

YALE



YA-34D

LAT.

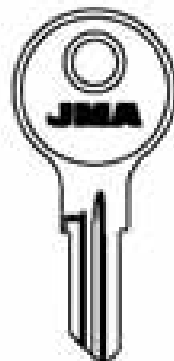

YA-36D

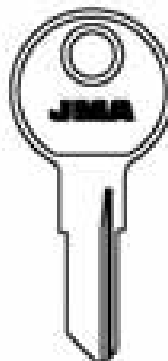

YA-37 YA-37D
AREMCO-BENDIX-CHICAGO
FORT-ILLINOIS

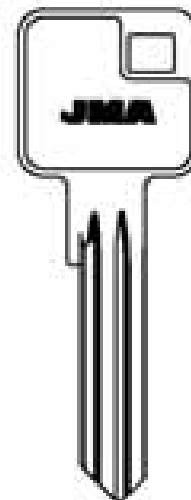

YA-38D

Copyright by
Algebra Almas S.A.
2010

JMA

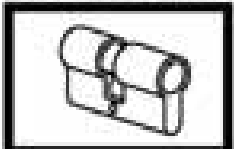

139

PARA-FOR:

**YALE
(D-GB-USA)**

YARDENI (IL)

YETI (RC)

PARA-FOR: **YALE**

*WTC.
 ...D AL B
 *YA-52D
 Y
 YA-51
 Y
 YA-50
 C
 YA-51D
 L
 YA-50D
 LAT.
 YA-72
 DRAPER
 YA-79D

PARA-FOR: **YALE**

LAT.
 YA-81
 YA-85D
 YA-88
 ASIA ALLOY
 YA-89
 ASIA ALLOY

PARA-FOR: **YARDENI**

ALP.
 YAR-1
 YAR-2
 LAT.

PARA-FOR: **YETI**

ASIA
 ASIA
 BELL
 BERA
 FOUR CIRCLE
 HAIDE
 HENY
 HENY
 HENY
 HEAD
 LOTUS
 RAM
 ROYAL
 SANCHUN
 SWAN
 VELO
 VISO
 WINFIELD
 ZEDAN
 YET-1
 YET-1D
 YET-14
 YET-14D
 YET-2
 YET-2D
 YET-16

Copyright by
Allegre Altes S.A.
1978

JMA

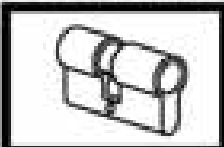

140

PARA:
FOR:

YETI

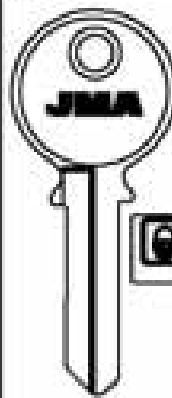

AKIRA
ASA
BELL
DEHA
FOUR CIRCLE
HAIDE
HEMY
HERMES
HEAD
LOTUS
RAM
ROYAL
SANCHEM
SWAN
YELO
YISO
WINFIELD
SELAN

YET-15

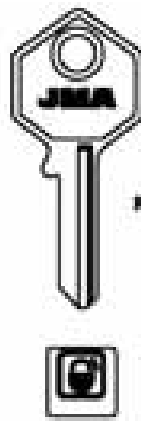

AKIRA
ASA
BELL
DEHA
FOUR CIRCLE
HAIDE
HEMY
HERMES
HEAD
LOTUS
RAM
ROYAL
SANCHEM
SWAN
YELO
YISO
WINFIELD
SELAN

YET-4

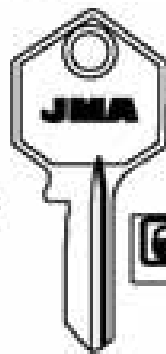

AKIRA
ASA
BELL
DEHA
FOUR CIRCLE
HAIDE
HEMY
HERMES
HEAD
LOTUS
RAM
ROYAL
SANCHEM
SWAN
YELO
YISO
WINFIELD
SELAN

YET-5



AKIRA
ASA
BELL
DEHA
FOUR CIRCLE
HAIDE
HEMY
HERMES
HEAD
LOTUS
RAM
ROYAL
SANCHEM
SWAN
YELO
YISO
WINFIELD
SELAN

YET-7

YET-5D

YET-7D

PARA-FOR:

- YETI (RC)
- ZADI (I)
- ZENI (GB)

PARA:
FOR:

YETI

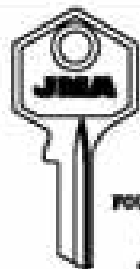

AKIRA
ASA
BELL
DEHA
FOUR CIRCLE
HAIDE
HEMY
HERMES
HEAD
LOTUS
RAM
ROYAL
SANCHEM
SWAN
YELO
YISO
WINFIELD
SELAN

YET-8



AKIRA
ASA
BELL
DEHA
FOUR CIRCLE
HAIDE
HEMY
HERMES
HEAD
LOTUS
RAM
ROYAL
SANCHEM
SWAN
YELO
YISO
WINFIELD
SELAN

YET-9



AKIRA
ASA
BELL
DEHA
FOUR CIRCLE
HAIDE
HEMY
HERMES
HEAD
LOTUS
RAM
ROYAL
SANCHEM
SWAN
YELO
YISO
WINFIELD
SELAN

YET-10



AKIRA
ASA
BELL
DEHA
FOUR CIRCLE
HAIDE
HEMY
HERMES
HEAD
LOTUS
RAM
ROYAL
SANCHEM
SWAN
YELO
YISO
WINFIELD
SELAN

YET-11



AKIRA
ASA
BELL
DEHA
FOUR CIRCLE
HAIDE
HEMY
HERMES
HEAD
LOTUS
RAM
ROYAL
SANCHEM
SWAN
YELO
YISO
WINFIELD
SELAN

YET-12

PARA:
FOR:

ZADI

ZENI



...1-1885
...5001-8278
E...1-710

ZA-1
BETTER

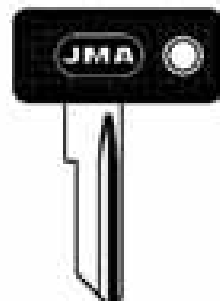

...1-1885
...5001-8278
E...1-710

ZA-1.P
BETTER

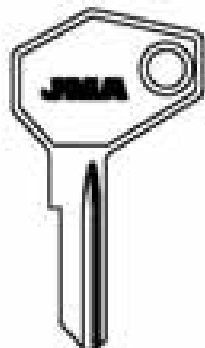

...1-1885
...5001-8278
E...1-710

ZA-12
BETTER

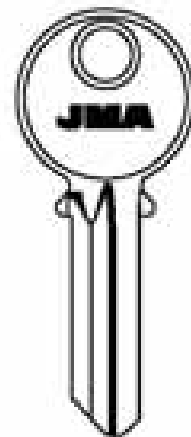

ZEN-1D

Copyright by
Allegre Altesa S.A.
2010

JMA

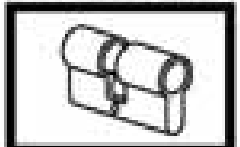

141

LLAVES PARA VEHÍCULOS

IBILGAILUENTZAKO GILTZAK

KEYS FOR VEHICLES

CLÉS POUR VÉHICULES

FAHRZAUGESCHLÜSSEL



THE KEY TO EXCELLENCE
GLOBALLY UNLOCKING MILLIONS OF DOORS DAILY

PARA:
FOR:

ABSA

PARA-FOR:

ABSA (E)

ABUS (D)

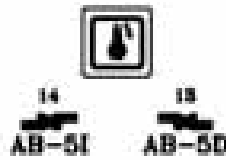
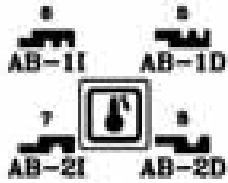
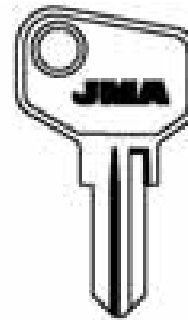
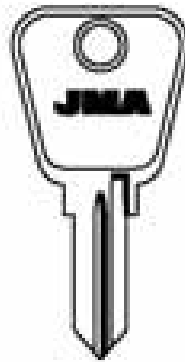
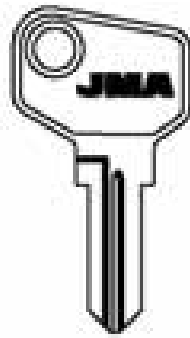
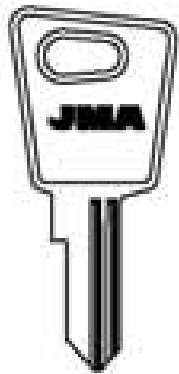

M.LUNA

PROALTO

PROER

ABPE-PROER-EXYA

PARA:
FOR:

ABSA

ABUS

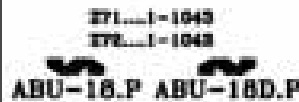
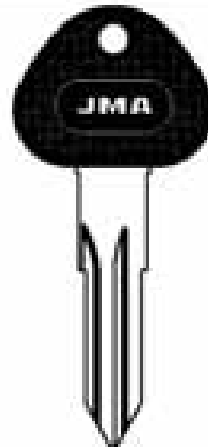
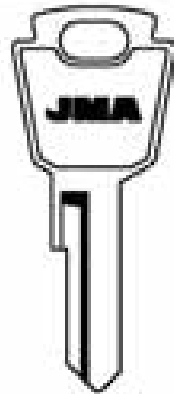
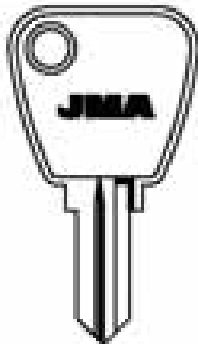

SUFFO

SUFFO

PARA:
FOR:

ABUS

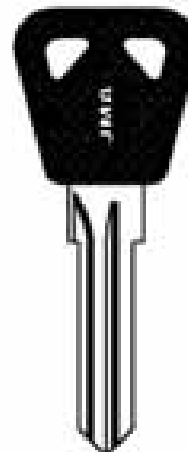
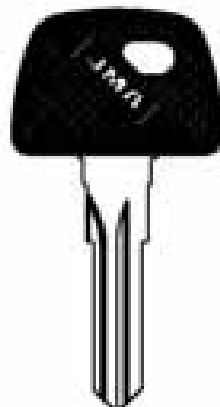
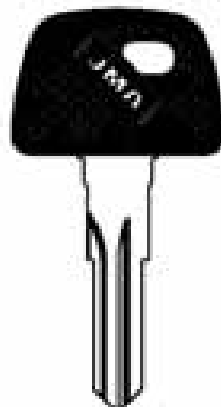

SUFFO

SUFFO

Copyright by
Alejandro Altman S.A.
2010

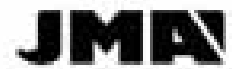

PARA-FOR:

AKS (D)



ALPHA (J)

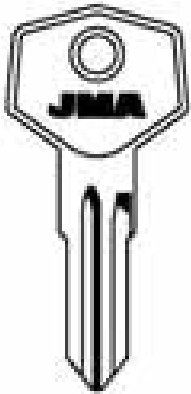
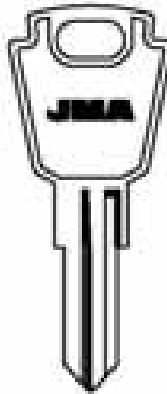
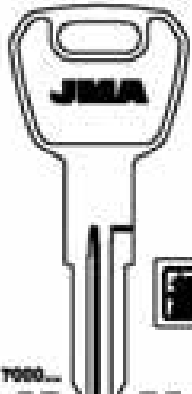
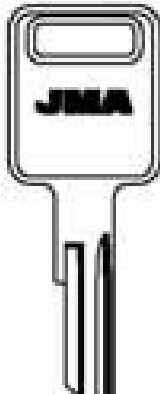

AMERICAN M.
(USA)

ASSA (S)

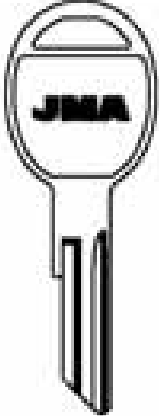
AXA (S)

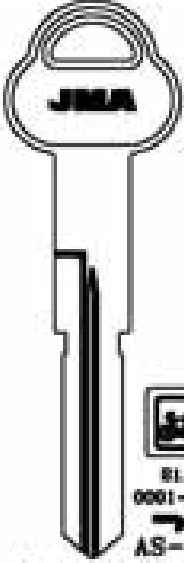
PARA-FOR:	AKS	ALPHA		AMERICAN MO.
	 <p>KA 001-100 AKS-1 YK90</p>	 <p>E...301-600 ALP-11 ALP-1D FBI</p>	 <p>7000... ALP-2 ALP-2D JD-LINCE-MORACOR SANTY-YEONIC E...301-600 ALP-6 ALP-6D FBI</p>	 <p>LAT. AMM-1</p>

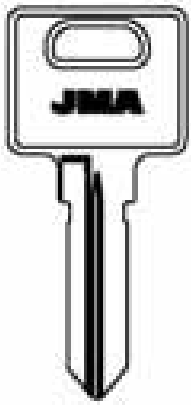
PARA-FOR:	AMERICAN	ASSA		
	 <p>LAT. AMM-2</p>	 <p>E... 1001-3000 AS-11 AS-1D T... E... 1001-3000 AS-24 AS-24D SANT-YEONIC</p>	 <p>700-7999 8000-8999 AS-21 AS-2D</p>	 <p>E1... 0001-9999 AS-17D MORACOR CYCLOS</p>

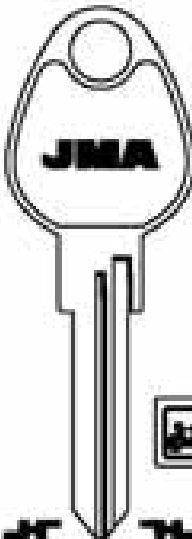
PARA-FOR:	ASSA			AXA
	 <p>E1... 0001-9999 AS-19D</p>	 <p>7000-7999 8000-8999 A... A... 7000-7999 8000-8999 AS-21 AS-21D</p>	 <p>7000-7999 8000-8999 A... A... 7000-7999 8000-8999 AS-21.P AS-21D.P</p>	 <p>AX-1 AX-1D</p>

Copyright by
Alpacra Altos S.A.
1978

JMA



144

PARA:
FOR:

AXA

AZU

PARA-FOR:

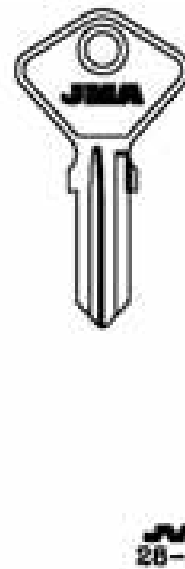
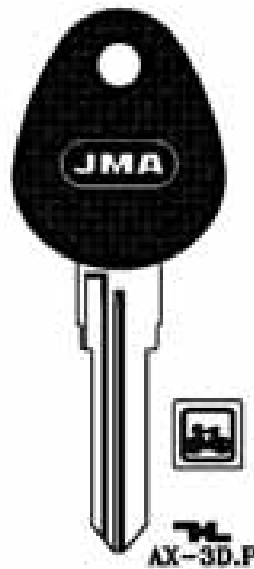

AX-1.P AX-1D.P

AX-2.P

LAT.

AX-3D.P

2B-D

PARA:
FOR:

BASCO

BLAU

AXA (S)

AZU (E)

BASCO (USA)

BLAU (D)

BOMORO (D)

BOSCH (D)

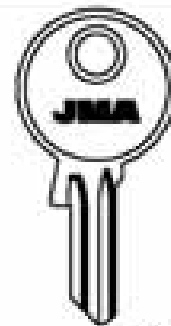
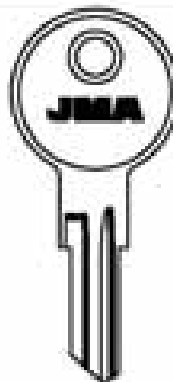
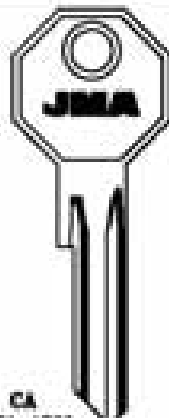

E.D
E20-814
K
0001-1000 8000-9499
BAS-11 BAS-1D
GENERAL SYSTEMS-SOLAR
CORDEN

CA
0001-1899
BAS-21 BAS-2D
D,C,P,D
BAS-3
CORBIN-YALE

BAS-4
AMERICAN K-BAS-CHICAGO C.
ELMO-HEESE E-ILLINOIS-YALE

EMOR
FLORA
EX
LENE
POS
WESCO
50-59 30-34
BL-11 BL-1D

PARA:
FOR:

BLAU

BOMORO

BOSCH

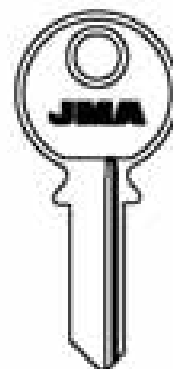
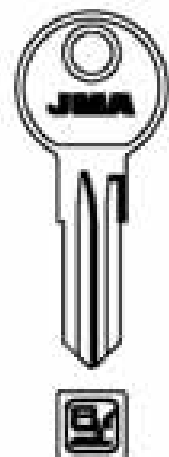
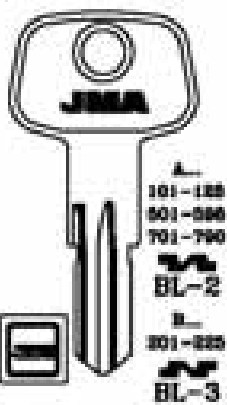

A
101-120
501-599
701-799
BL-2
B
301-320
BL-3

A
BL-4 BL-4D
A 301-320 B 101-120
BL-6 BL-6D

1-200
BL-1-200
BL-5 BL-5D

BOM-2 BOM-2D

E.M.N.U.S.A.
001-100
H.G.N H.G.
140-189 340-100
BH-1

PORT-BE-WARD

LAFORTE-PIRELLA

HEIMAN

Copyright by
Algebra Atlas S.A.
2018

JMA



145

PARA-FOR:

BOSCH (D)
BRABANTIA (E)
B. & S. (USA)

PARA-FOR: **BOSCH**

BH-1.P
 H.C.N. H.C.
 140-188 040-100
 NEUMAN

BH-2
 FAT PRESS-MADE IN-ROTOR

BH-3

BH-4
 7.1 .26
 SEMI-CUT-ON PRESS-BLLET
 SOLE-POLAR

PARA-FOR: **BOSCH**

BH-5

BH-6

PARA-FOR: **BRABANTIA**

BRA-2

PARA-FOR: **B. & S.**

BS-11
 N
 1601-1700
 NA
 001-200
 AMERICAN NOTCH-BACK
 DICTER

PARA-FOR: **B. & S.**

BS-2
 E...250-814
 L...1000

BS-3D

















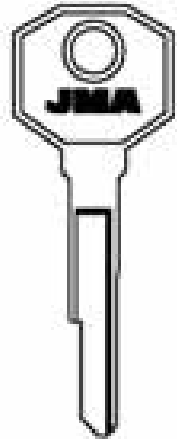

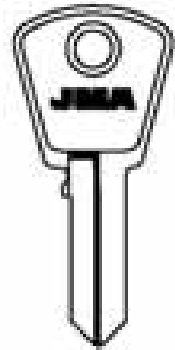

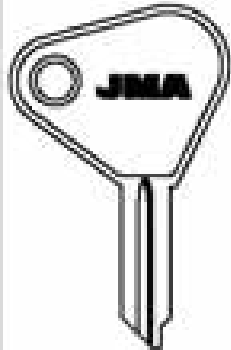

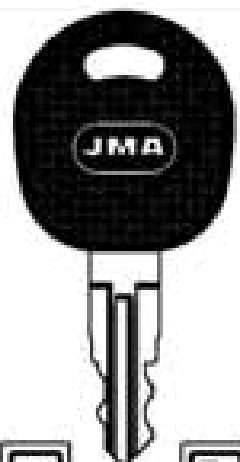

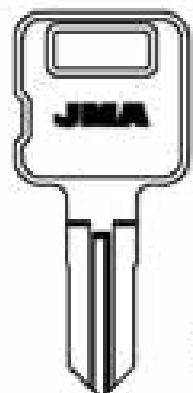

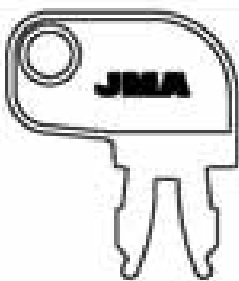

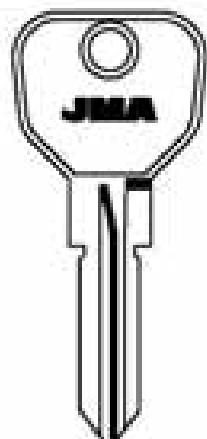
BS-6
 A...250-1500 GC... 101-150
 AP...250-1500 HC...
 B...250-1500 D-400
 C...1281-1700
 CS...250-1500 BS-4D
 DC-EP...250-699
 F...250-1500

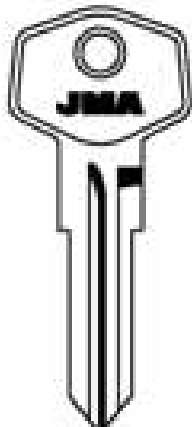
BS-5
 D
 250-814
 K
 01-1000

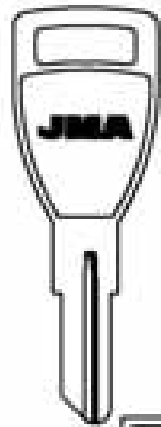
Copyright by
 Alejandro Altamir S.A.
 2018

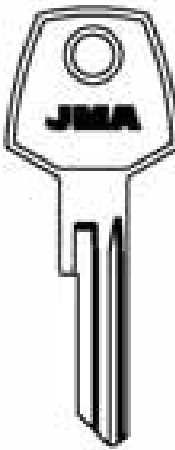
JMA

146



PARA: FOR: B. & S.	BURG	CAMA	CASELLAS	PARA-FOR:
 <p>  BS-7  BS-8  BS-9  BS-7D  BS-8D  BS-9D CY...1-1800 </p>	 <p>  BUR-6 </p>	 <p>  CAM-1D FINT </p>	 <p>  CAS-1D </p>	B. & S. (USA) BURG (D) CAMA (I) CASELLAS (E) CATERPILLAR (USA) CEM (GB) CESSNA (USA) CHRYSLER (USA)
PARA: FOR: CATERPILLAR		CEM		
 <p>  CAT-1.P </p>	 <p>  CAT-2 LIT. </p>	 <p>  CAT-3 LIT. </p>	 <p>  CEM-BP </p>	
PARA: FOR: CEM	CESSNA	CHRYSLER		
 <p>  CEM-JC  PO-5 <small>8001-802 8001-1000</small> <small>8001B-8001C-8001D-8001E-8001F</small> </p>	 <p>  CN-1D FJ <small>800-900</small> </p>	 <p>  CHR-1 YALE </p>	 <p>  CHR-2 BOSS </p>	<p> Copyright by Alejandro Altamir S.A. 2018 JMA  147 </p>

PARA-FOR:

**CHRYSLER
(USA)**

PARA-FOR:

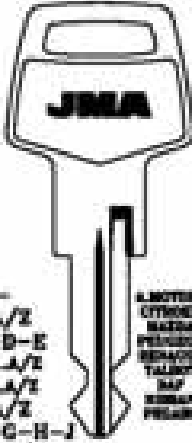
CHRYSLER

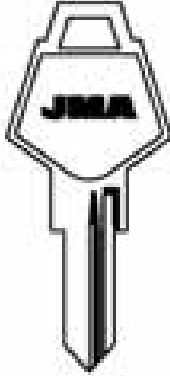
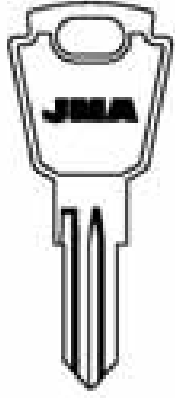
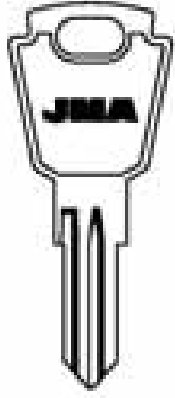
 <p>.....A/Z B-C-D-E 1/2.....A/Z 1/2.....A/ZA/Z B-D-E-G-H-J 1/2.....A/Z 1/2.....A/Z E-M-N-P-R</p> <p>CHR-3</p> <p>CLAUSON-NEIMAN</p>	 <p>.....A/Z B-C-D-E 1/2.....A/Z 1/2.....A/ZA/Z B-D-E-G-H-J 1/2.....A/Z 1/2.....A/Z E-M-N-P-R</p> <p>CHR-3.P</p> <p>CLAUSON-NEIMAN</p>	 <p>CHR-5</p> <p>NEIMAN-PELLEU BOCE</p>	 <p>CHR-6</p> <p>001-004</p>	 <p>CHR-6D</p> <p>001-004</p>
--	--	--	--	---

PARA-FOR:

CHRYSLER

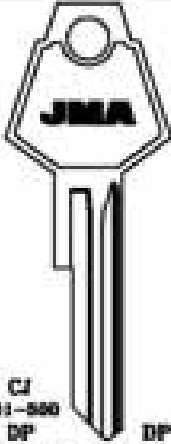
 <p>CJ 001-500 DP 0001-1400 EP 0001-3000</p> <p>CHR-7</p> <p>CHRYSLER YALE</p>	 <p>CJ 001-500 DP 0001-1400 EP 0001-3000</p> <p>CHR-7.P</p> <p>CHRYSLER YALE</p>	 <p>F.... G.... 0000-1204</p> <p>CHR-8</p> <p>AMERICAN MOTOR-CHRYSLER-JEEP YALE</p>	 <p>F.... G.... 0000-1204</p> <p>CHR-8.P</p> <p>AMERICAN MOTOR-CHRYSLER-JEEP YALE</p>
---	---	---	--

PARA-FOR:

CHRYSLER

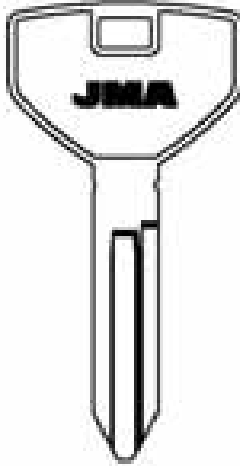
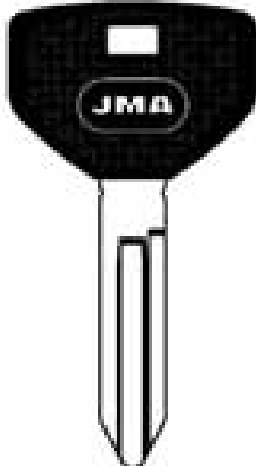
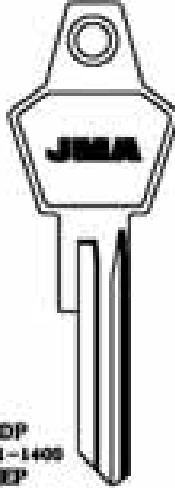
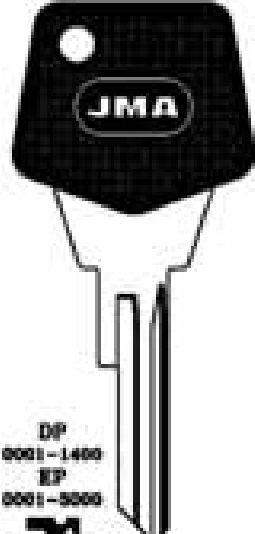
 <p>J.... 0001-3500</p> <p>CHR-10</p> <p>AMERICAN MOTOR-CHRYSLER-JEEP YALE</p>	 <p>J.... 0001-3500</p> <p>CHR-10.P</p> <p>AMERICAN MOTOR-CHRYSLER-JEEP YALE</p>	 <p>DP 0001-1400 EP 0001-3000</p> <p>CHR-11</p> <p>CHRYSLER YALE</p>	 <p>DP 0001-1400 EP 0001-3000</p> <p>CHR-11.P</p> <p>CHRYSLER YALE</p>
--	--	---	--

Copyright by
Alfredo Altini S.A.
1978

JMA



148

PARA:
FOR:

CHRYSLER

PARA-FOR:

CHRYSLER
(USA)









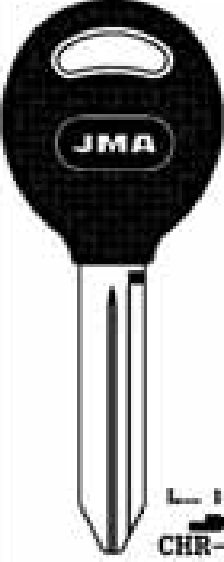
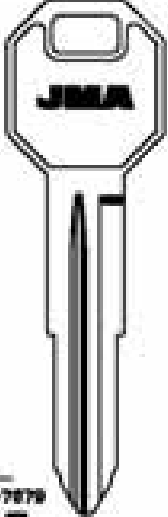

CLAUSOR (E)

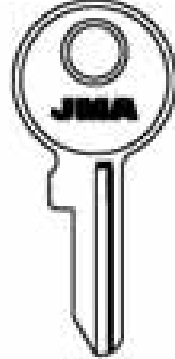
			
<p>DE... 0001-1400</p> <p>ES... 0001-3000</p> <p> CHR-12</p> <p>CHRYSLER</p> <p>BRIDGE & STRATTON</p>	<p>CY 0001-1800</p> <p>DE 0001-1800</p> <p>ES 0001-1500</p> <p> CHR-13D</p> <p>CHRYSLER</p> <p>BRIDGE & STRATTON-YALE</p>	<p>L... 1-3500</p> <p> CHR-14.P</p> <p>CHRYSLER</p> <p>BRIDGE & STRATTON-YALE</p>	<p>L... 1-3500</p> <p> CHR-15</p> <p>CHRYSLER</p> <p>BRIDGE & STRATTON-YALE</p>

PARA:
FOR:





CHRYSLER

CLAUSOR

			
<p>L... 1-3500</p> <p> CHR-15.P</p> <p>CHRYSLER</p> <p>BRIDGE & STRATTON-YALE</p>	<p>L... 0001-7579</p> <p> CHR-17</p> <p>CHRYSLER</p> <p>BRIDGE & STRATTON-YALE</p>	<p>ALLI</p> <p></p> <p></p> <p> CL-11</p> <p>BRABANTIA</p>	<p> CL-21</p> <p> CL-2D</p> <p>BRABANTIA-ALLI-PLACER 1987A</p>

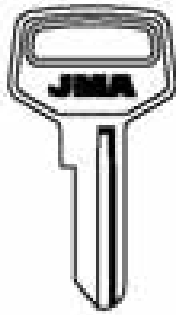
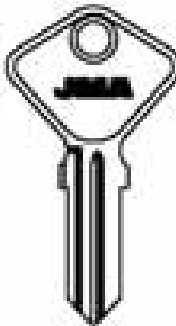
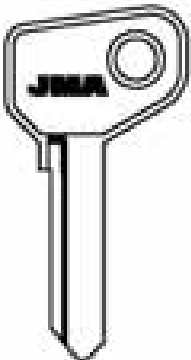
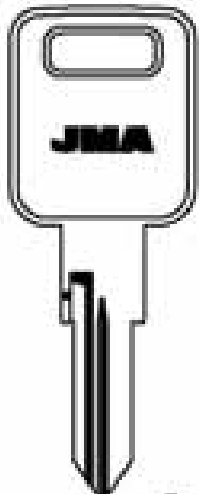
PARA:
FOR:

CLAUSOR

			
<p> CL-31</p> <p>BRABANTIA-ALLI-PLACER 1987A</p>	<p> CL-41</p> <p>ALLI</p>	<p> CL-5D</p> <p>ALLI</p>	<p> CL-6</p> <p>ALLI</p>

Copyright by
Aljeandro Allina S.A.
2018

JMA



149



PARA-FOR:

- CLAUSOR (E)**
- CLICK (RA)**
- CLUM (USA)**
- COBRA (D)**
- DACIA (R)**

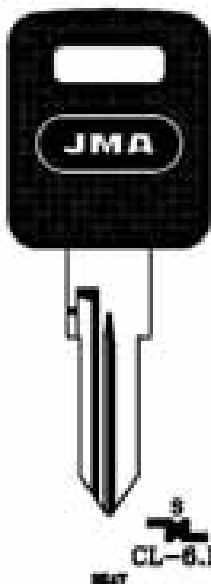
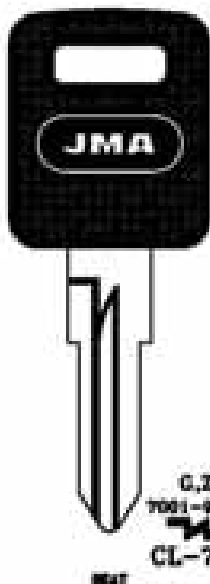
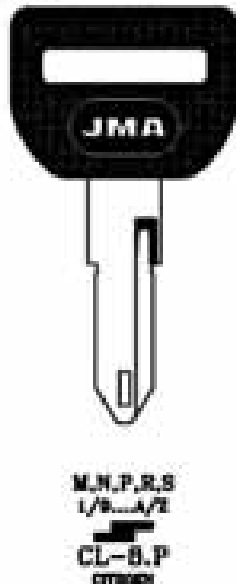
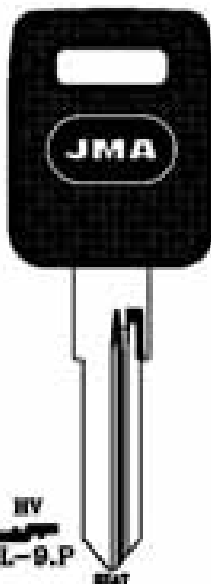

PARA-FOR: **CLAUSOR**

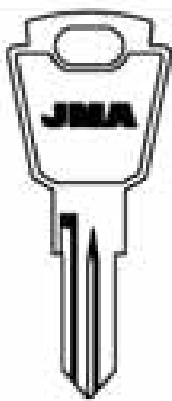
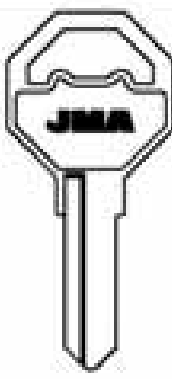
 <p>5 CL-6.P BMW</p>	 <p>6,2 7001-9008 CL-7.P BMW CLOBERT</p>	 <p>M,N,P,R,S 1/2...A/2 CL-8.P CITROEN</p>	 <p>8V CL-9.P BMW</p>
---	---	--	--

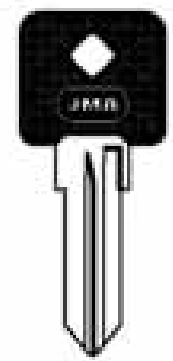
PARA-FOR: **CLAUSOR** **CLICK** **CLUM** **COBRA**

 <p>SIM-900</p>	 <p>CLI-1D</p>	 <p>CLU-11 CLU-1D CLU-2 CLU-3 CLU-4 CLU-5 MERCURY</p>	 <p>COB-1.P</p>
---	--	---	---

PARA-FOR: **COBRA** **DACIA**

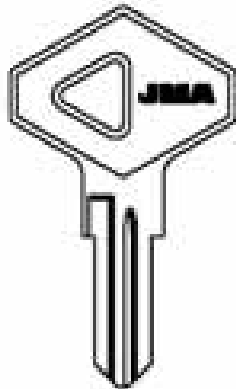
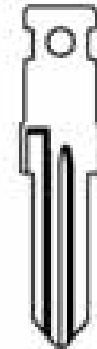
 <p>COB-2</p>	 <p>DAC-1D.P</p>	 <p>DAC-2D</p>	 <p>DAC-3DC1</p>
--	---	--	---

Copyright by
Alfonso Altom S.A.
1978

JMA



150

PARA-FOR: DAE LIM

DAEWOO

PARA-FOR:

- DAELIM (K)
- DAEWOO (K)
- DAIHATSU (J)
- DARMIX (F)

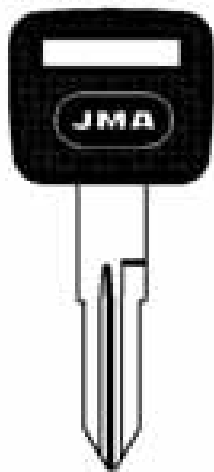

DAL-1P

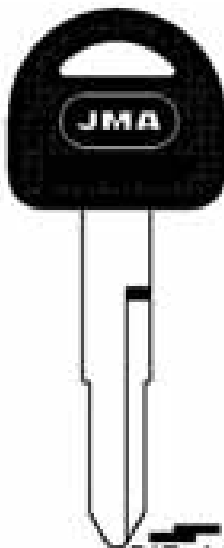

DAE-1.P

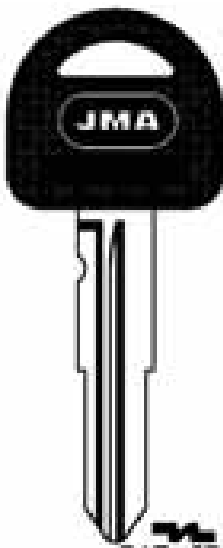

DAE-2D.P

PARA-FOR:

DAEWOO

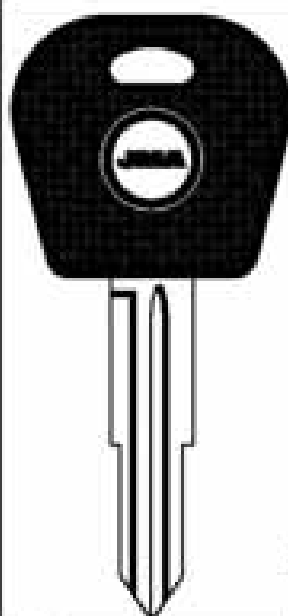

DAE-4.P1



DAE-3D.P1



DAE-4D.P1

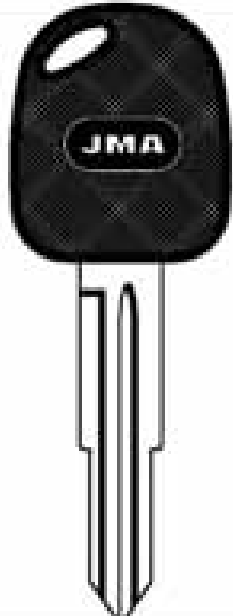

DAE-3.P2



DAE-3D.P2

PARA-FOR: DAEWOO

DAIHATSU

DARMIX

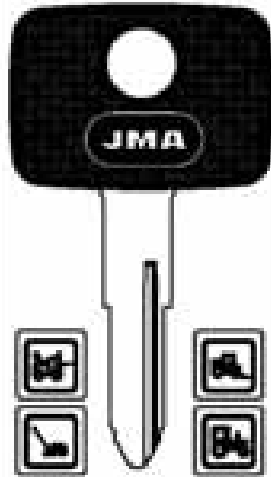

DAE-5.P

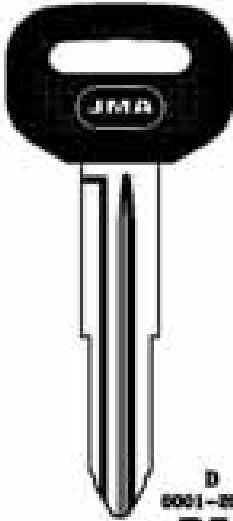
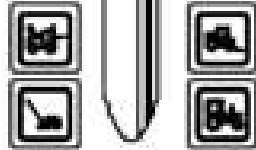

DAI-1.P

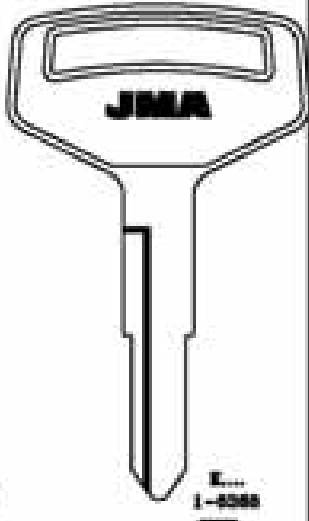

DAI-2D

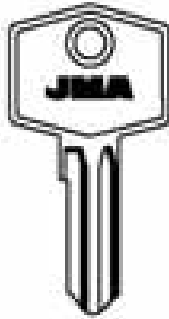

DAR-1

Copyright by
Magnum Alarm S.A.
2010











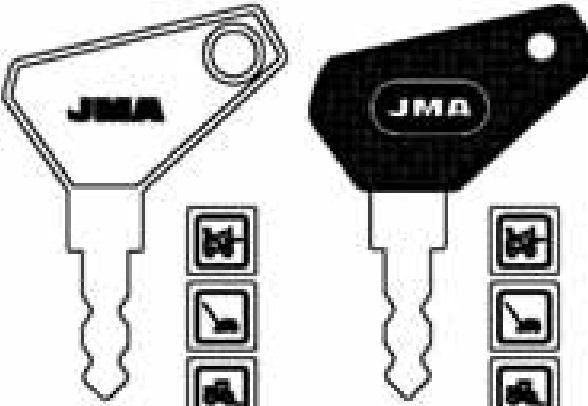

JMA





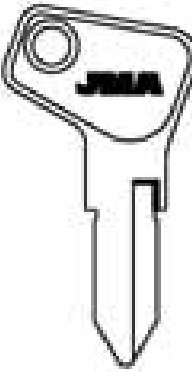





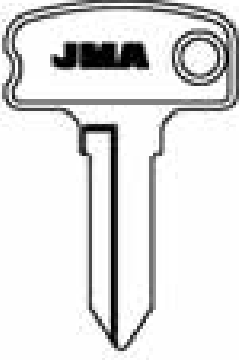

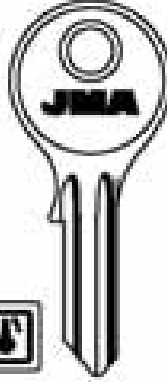



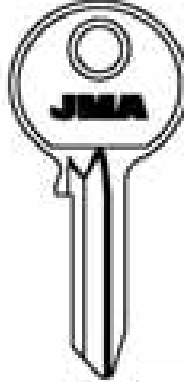





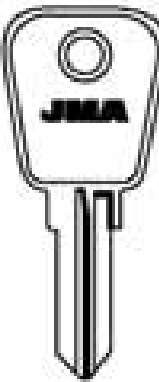

151

PARA-FOR:

- DAV (F)
- DOBLE G. (ARG)
- DOBLINA (D)
- DOM (D)
- DUBOIS (F)
- ECHO (I)
- FAAB (I)

PARA-FOR:	DAV	DOBLE G	DOBLINA
	 <p>     </p> <p>  DAV-1  DAV-1.P <small>DAV-BACE-REDAULT SAFEM</small> </p>	 <p>  GG-1D </p>	 <p>  DOB-1  DOB-1D 10000-44001  DOB-2  DOB-2D <small>TRABATT-FAITREUSE</small> </p>

PARA-FOR:	DOBLINA	DOM		
	 <p>  DOB-3  DOB-3D <small>TRABATT-FAITREUSE</small> </p>	 <p>  </p> <p> EV...1-2040 GS...1-1000 FT...1-1000 CQ...301-400 ...1-1000 </p> <p>  DOM-9  DOM-9D H000 </p>	 <p>  </p> <p> FI-C2 0001-2048 </p> <p>  DOM-14D </p>	 <p>  DOM-38D </p>

PARA-FOR:	DUBOIS	ECHO	FAAB	
	 <p>  DU-1 <small>PLANO-TYEL</small> </p>	 <p>  </p> <p>  ECH-1 </p>	 <p>    </p> <p> 100-309  FAB-1 </p>	 <p>  </p> <p> 100-309  FAB-2 </p>

Copyright by
Alphonse Alliez S.A.
1818





152

PARA:
FOR:

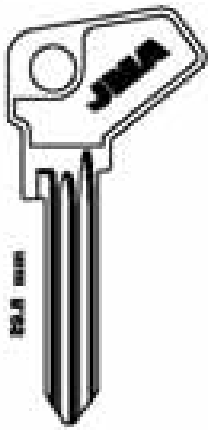
FAB

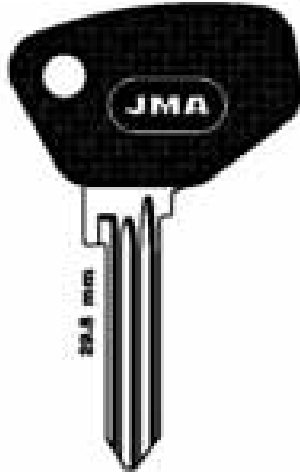

SKO-1



SKO-1.P

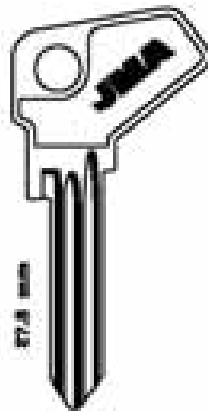

SKO-2

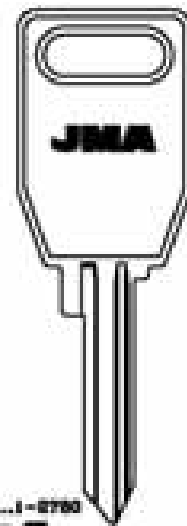

SKO-3I

PARA-FOR:

FAB (CZ)

FAICA (E)

FARMA (I)

PARA:
FOR:

FAB

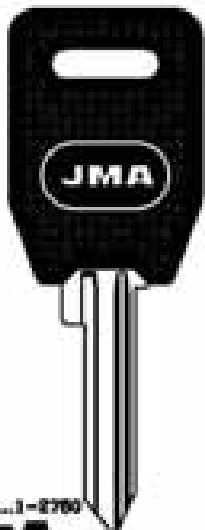

SKO-3I.P

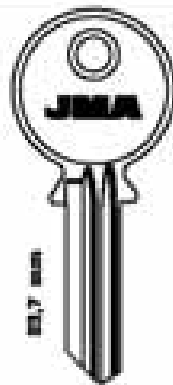

SKO-4

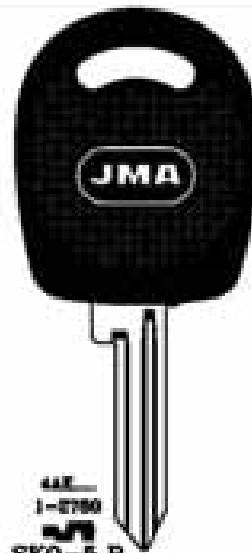

SKO-5.P



SKO-6

PARA:
FOR:

FAB

FAICA

FARMA

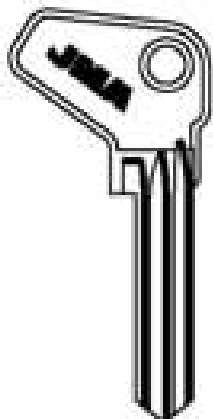

SKO-8

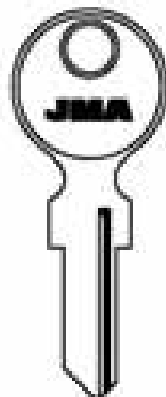

FAI-A, FAI-B, FAI-C, FAI-D

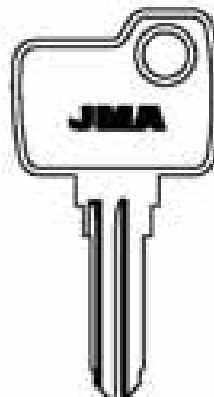

FAR-11, FAR-2I, FAR-3, FAR-3D, FAR-4D

FAR-11, FAR-1D, FAR-2I, FAR-2D, FAR-3, FAR-3D, FAR-4D

FAB

Copyright by
Algebra Altesa S.A.
2018

JMA

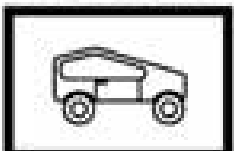

153



PARA-FOR:

FEMSA (E)

FIAT (I)

FIST (I)

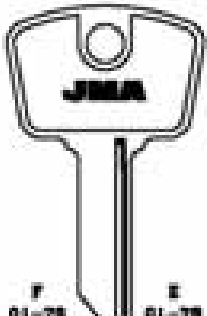
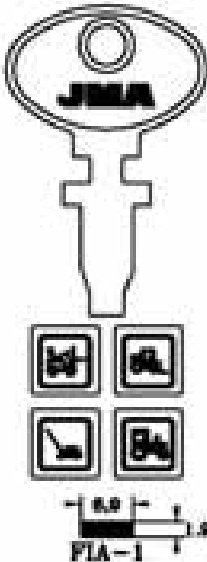
FORD (USA)

PARA FOR: FEMSA	FIAT	FIST
 <p>F 01-78 FEM-11</p> <p>E 01-78 FEM-1D</p> <p>H 01-78 FEM-21</p> <p>G 01-78 FEM-2D</p> <p>FEM-31</p> <p>FEM-3D</p>	 <p>FLA-1</p> <p>FLA-2</p>	 <p>FIS-1D</p>

PARA FOR: FORD

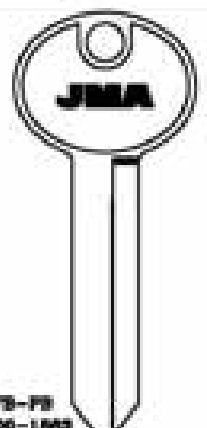
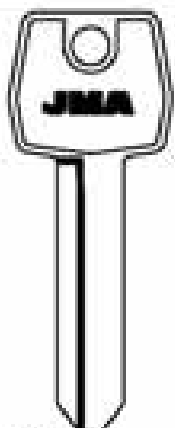
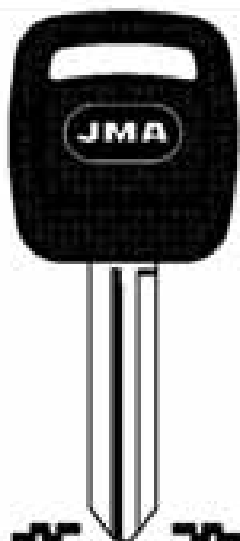
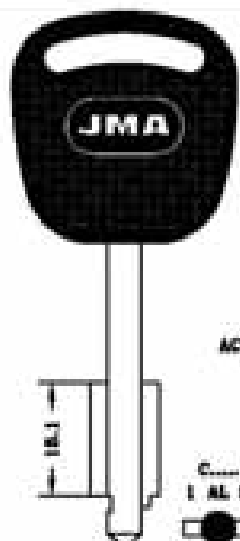
 <p>FB-FB 0000-1863 FO-1</p> <p>FO-3</p> <p>FO-3D</p> <p>FORD (USA)</p>	 <p>AF 0001-2800 FA-PA 0000-1863 FO-2</p> <p>FORD (USA)-SULLERT</p>	 <p>FO-3.P</p> <p>FO-3D.P</p> <p>FORD (USA)</p>	 <p>ACE</p> <p>18.1</p> <p>C... I AL B</p> <p>FO-4.P</p> <p>FORD SOLD</p>
---	---	--	---

PARA FOR: FORD

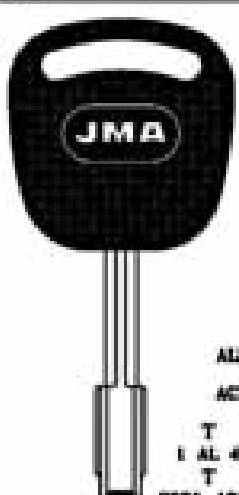
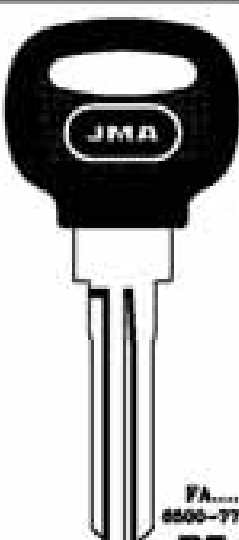
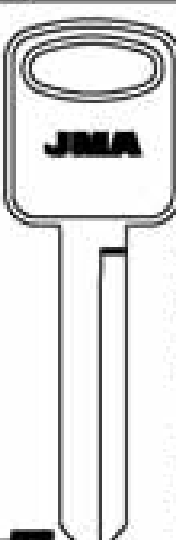
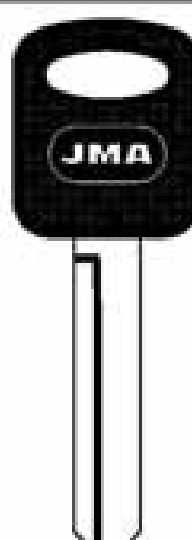
 <p>ALP.</p> <p>ACE.</p> <p>T I AL 4 T 0001-1060</p> <p>FO-6.P</p> <p>FORD HUP</p>	 <p>FA... 6500-7733</p> <p>FO-7.P</p> <p>FORD</p>	 <p>A 101-291 501-579</p> <p>B 101-332 501-602</p> <p>C 101-344 501-524</p> <p>D 101-327 501-602</p> <p>E 101-298 501-579</p> <p>FO-8</p> <p>FO-8D</p> <p>FORD</p>	 <p>A 101-291 501-579</p> <p>B 101-332 501-602</p> <p>C 101-344 501-524</p> <p>D 101-327 501-602</p> <p>E 101-298 501-579</p> <p>FO-8D.P</p> <p>FORD</p>
---	--	--	---

Copyright by
Alpargatas Alltosa S.A.
1978

JMA



154

PARA:
FOR:

FORD

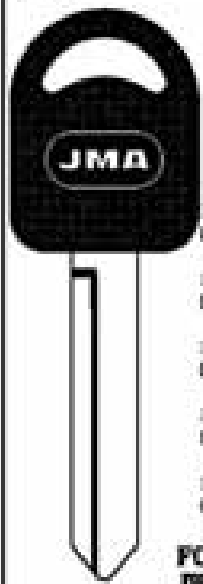

A
101-091
501-079

B
101-092
501-080

C
101-044
501-024

D
101-087
501-002

E
101-090
501-079

FO-8D.P1
FORD-MERCUY

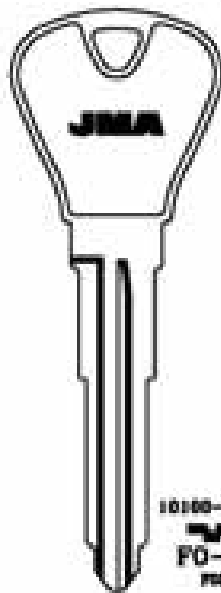

10100-10000

FO-9D
FORD

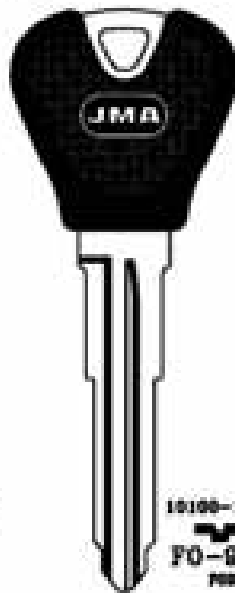

10100-10000

FO-9D.P
FORD

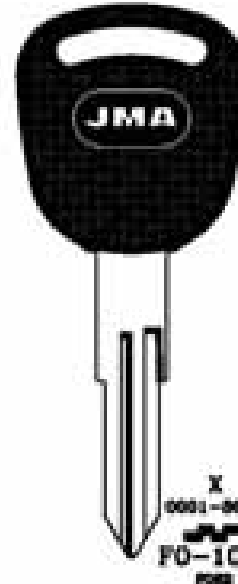

X
0001-0000

FO-10.P
FORD

PARA-FOR:

FORD (USA)

PARA:
FOR:

FORD

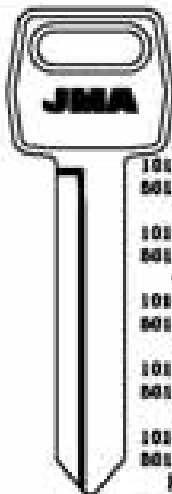

A
101-091
501-079

B
101-092
501-080

C
101-044
501-024

D
101-087
501-002

E
101-090
501-079

FA
0000-7730

FO-11D
FORD

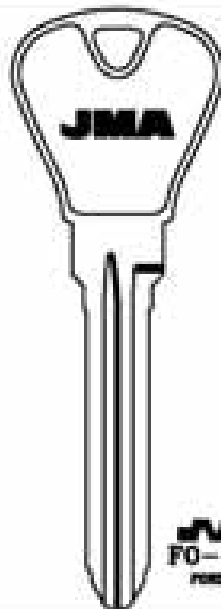

FO-12
FORD

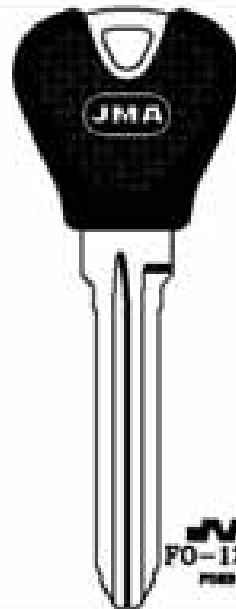

FO-12.P
FORD

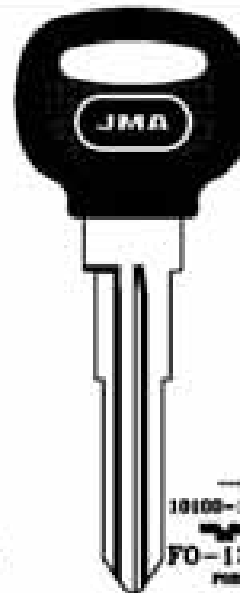

10100-10000

FO-13D.P
FORD

PARA:
FOR:

FORD

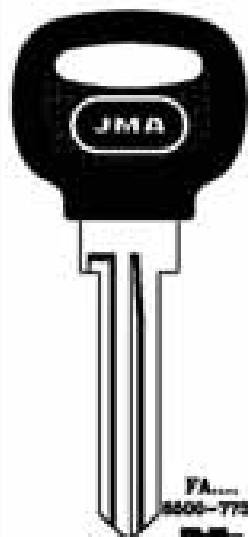

FA....
0000-7730

FO-14D.P
FORD

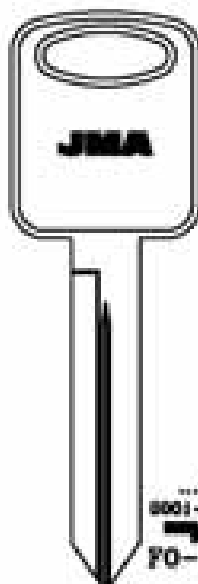

....X
0001-1700

FO-15D
STRATTEC

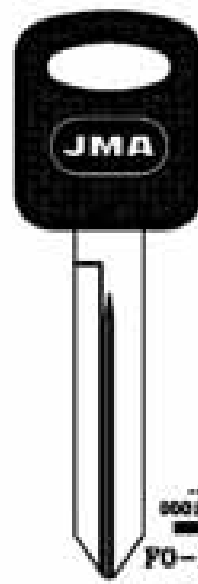

....X
0001-1700

FO-15D.P
STRATTEC

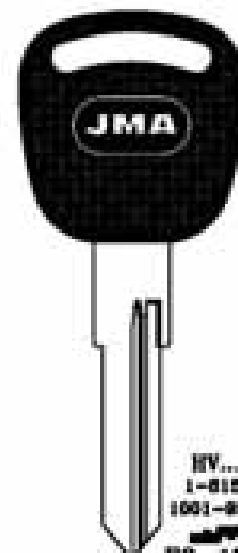

BV....
1-0104
1001-0000

FO-17.P
FORD

Copyright by
Allegre Almas S.A.
2010

JMA



155

PARA-FOR:

FORD (USA)

PARA-FOR: **FORD**

PARA-FOR: **FORD**

PARA-FOR: **FORD**

Copyright by
Alexandre Alloua S.A.
1978

JMA

156

PARA:
FOR:

FORD

PARA-FOR:

FORD (USA)
GAS (RA)
G.M. (USA)

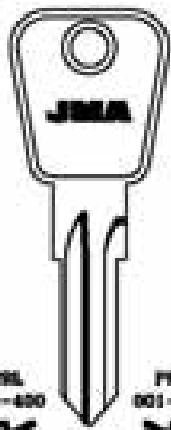

PRL
001-400
FO-PRL
XL
001-190
FO-XL
FO-PRL
FO-XL
FO-PRR
XR
001-190
FO-PRR
FO-XR
FO-PRR
FO-XR

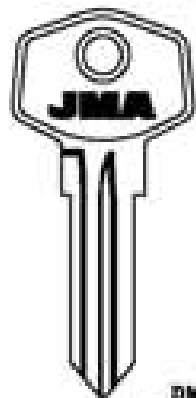

DM
200-400
TC-AK
0001-1000
TX
0001-1000
FO-TC
MAP-DADELS-FORD-GRILLE
CAST-CEM-EGOL

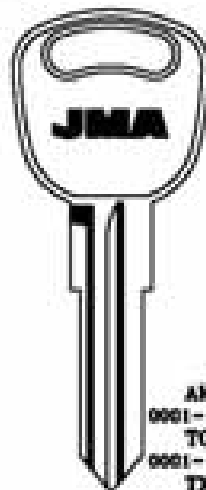

AK
0001-1000
TC
0001-1000
TX
0001-1000
FO-TX
CAST-CEM-CLAUSOR-EGOL-REINANCASI-CEM-CLAUSOR-EGOL-REINANC

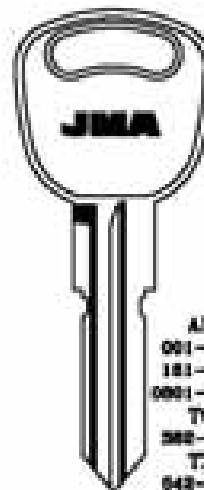

AK
001-100
181-250
0001-1000
TC
260-700
TX
040-071
1000-1001
FO-TX1

PARA:
FOR:

FORD

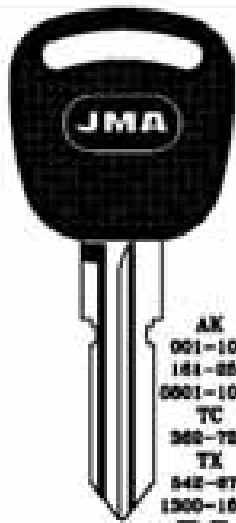

AK
001-100
181-250
0001-1000
TC
260-700
TX
040-071
1000-1001
FO-TX1.P

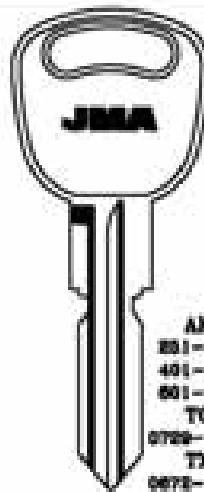

AK
201-300
401-500
601-700
TC
0700-1000
TX
0070-1000
1000-1000
FO-TX2

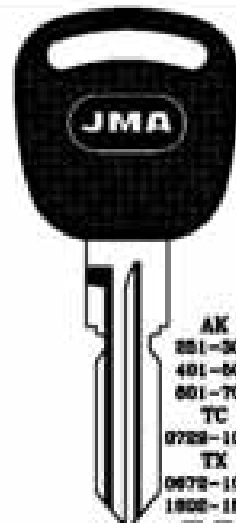

AK
201-300
401-500
601-700
TC
0700-1000
TX
0070-1000
1000-1000
FO-TX2.P



AK
0001-1000
TC
0001-1000
TX
0001-1000
FO-TXK.P

PARA:
FOR: FORD

GAS

GENERAL MOTORS

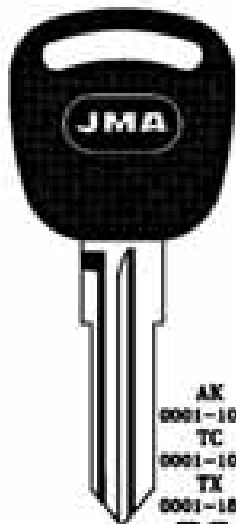

AK
0001-1000
TC
0001-1000
TX
0001-1000
FO-TX.P

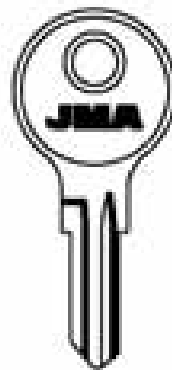

GAS-1
GAS-1D

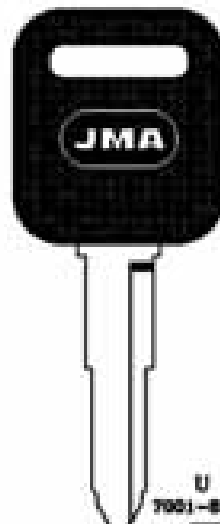

U
7001-8000
GM-1.P

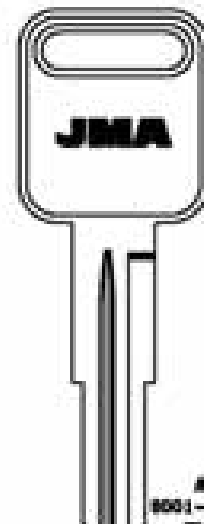

A
8001-9400
GM-2

CAST-CEM-CLAUSOR-EGOL-REINANC

BRIGGS STRATTON

BRIGGS STRATTON

Copyright by
Algebra Almas S.A.
2010

JMA



157

PARA-FOR:

G.M. (USA)

PARA-FOR:

GENERAL MOTORS



A
5001-8400
GM-2.P
C.A.

BRIGGS STRATTON

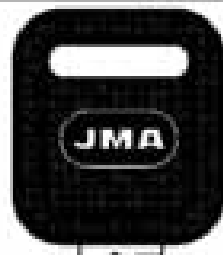

U
1-2000
GM-3.P
C.A.

BRIGGS S.

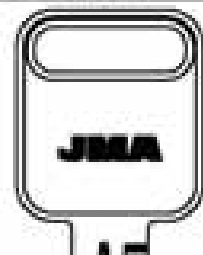

N
5001-7000
GM-4
C.A.

BRIGGS STRATTON

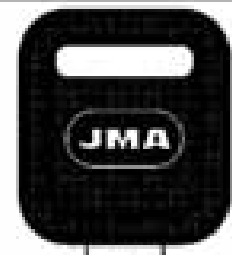

N
5001-7000
GM-4.P
C.A.

BRIGGS STRATTON

PARA-FOR:

GENERAL MOTORS



N
5001-7000
GM-4.P1
C.A.

BRIGGS STRATTON

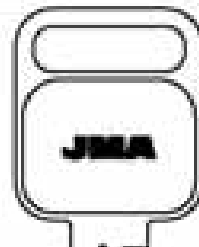

U
1-2000
GM-5
C.A.

BRIGGS S.



U
1-2000
GM-5.P
C.A.

BRIGGS S.

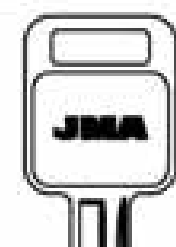

A
000-999
GM-6
E
000-999
GM-8
C
000-999
GM-7
J
000-999
GM-9
C.A.

BRIGGS STRATTON

PARA-FOR:

GENERAL MOTORS

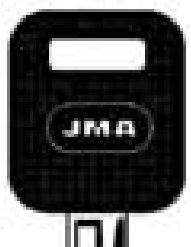

A
000-999
GM-6.P
E
000-999
GM-8.P
C.A.

BRIGGS STRATTON



C
000-999
GM-7.P
J
000-999
GM-9.P
C.A.

BRIGGS STRATTON

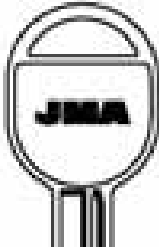

B
000-999
GM-10
H
000-999
GM-12
C.A.

BRIGGS STRATTON



D
000-999
GM-11
E
000-999
GM-13
C.A.

BRIGGS STRATTON

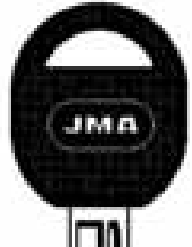

B
000-999
GM-10.P
H
000-999
GM-12.P
C.A.

BRIGGS STRATTON



D
000-999
GM-11.P
E
000-999
GM-13.P
C.A.

BRIGGS STRATTON

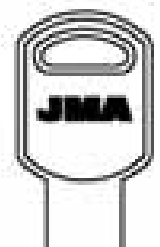

...000-7045
GM-14
C.A.

BRIGGS STRATTON

Copyright by
Algebra Alfa S.A.
1978

JMA



158

PARA:
FOR:

GENERAL MOTORS

PARA-FOR:

G.M. (USA)



A00-7945
GM-14.P

U.S.
BRIGGS STRATTON

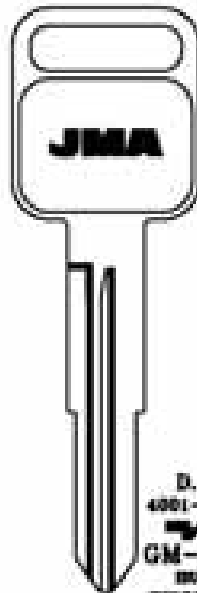

D...
4001-6000
GM-15D

U.S.
BRIGGS S.

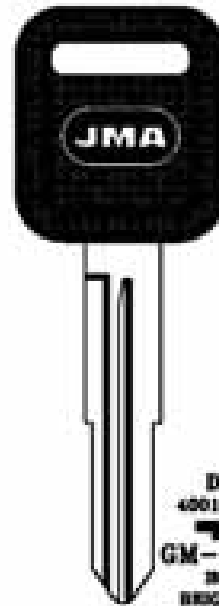

D...
4001-6000
GM-15D.P

U.S.
BRIGGS S.

PARA:
FOR:

GENERAL MOTORS

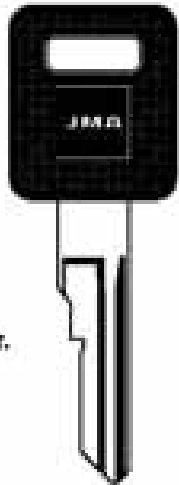

A
J.00.0-99.9
K.00.0-99.9
L.00.0-99.9
M.00.0-99.9
N.00.0-99.9
O.00.0-99.9
P.00.0-99.9

GM-16.P

E
J.00.0-99.9
K.00.0-99.9

GM-16.P

U.S.

BRIGGS STRATTON

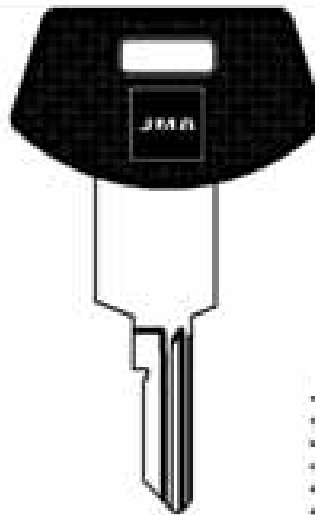

C
A.00.0-99.9
B.00.0-99.9
N.00.0-99.9
M.00.0-99.9
P.00.0-99.9
F.00.0-99.9

GM-17.P

C
A.00.0-99.9
B.00.0-99.9
N.00.0-99.9
M.00.0-99.9
P.00.0-99.9
F.00.0-99.9

GM-19.P GM-20.P

U.S.

BRIGGS STRATTON

PARA:
FOR:

GENERAL MOTORS

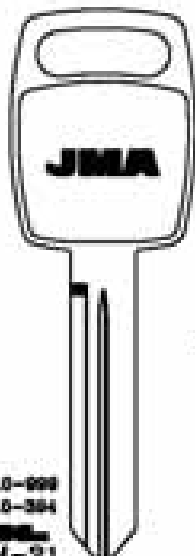

R.0-999
T.0-394
GM-21

U.S.
BRIGGS & STRATTON

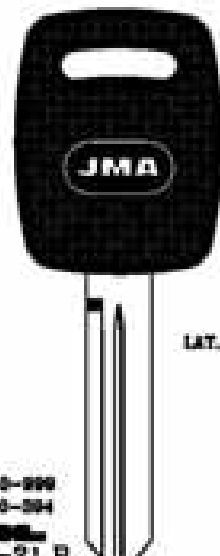

R.0-999
T.0-394
GM-21.P

U.S.
BRIGGS & STRATTON

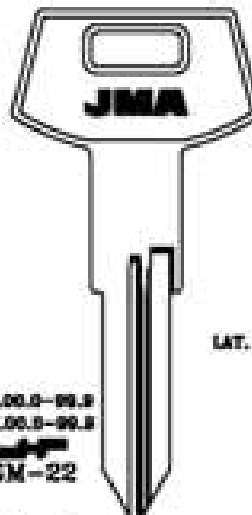

J.00.0-99.9
K.00.0-99.9
GM-22

GM-23

U.S.
BRIGGS STRATTON

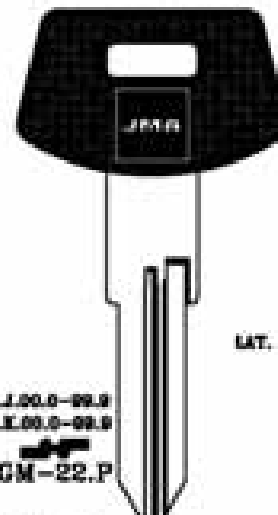

J.00.0-99.9
K.00.0-99.9
GM-22.P

GM-23.P

U.S.
BRIGGS STRATTON

Copyright by
Algebra Atlas S.A.
2018

JMA



159

PARA-FOR:

G.M. (USA)

GHE (D)

PARA-FOR: GENERAL MOTORS

1....
1-5000
GM-24
GM-107074
TOKAJ-BEKA

LAT.

1....
1-5000
GM-24.P
GM-107074
TOKAJ-BEKA

LAT.

...400-7145
GM-25
C.A.
BRUGES STRATTON

...400-7145
GM-25.P
C.A.
BRUGES STRATTON

PARA-FOR: GENERAL MOTORS

LAT.

GM-28

000-1000
GM-42

A
000-000
GM-A

C
000-000
GM-C

E
000-000
GM-E

C.A.
BRUGES STRATTON

A
000-000
GM-A.P

C
000-000
GM-C.P

E
000-000
GM-E.P

J
000-000
GM-J.P

C.A.
BRUGES STRATTON

PARA-FOR: GENERAL MOTORS

B
000-000
GM-B

D
000-000
GM-D

B
000-000
GM-B.P

D
000-000
GM-D.P

B
000-000
GM-H

K
000-000
GM-K

B
000-000
GM-H.P

K
000-000
GM-K.P

C.A.
BRUGES STRATTON

C.A.
BRUGES STRATTON

GHE

GH-I

GH-GX

GH-HX

PERONAUS-POB-RECO

Copyright by
Alphonse Allier S.A.
1978

JMA



160

PARA:
FOR:

GHE

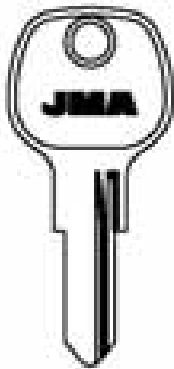

PS
138
GH-PS

GIOBERT

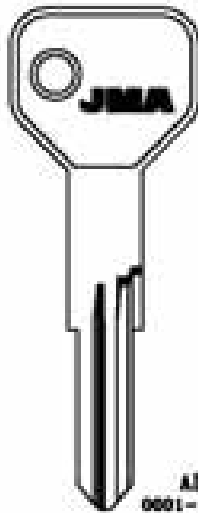

AL
0001-1274
AF-13
ALFA ROMEO
7500

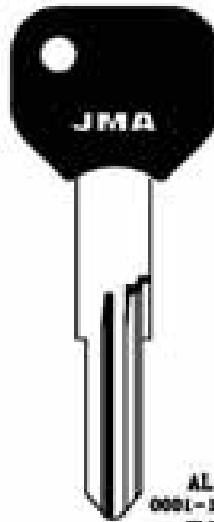

AL
0001-1274
AF-13.P
ALFA ROMEO
7500

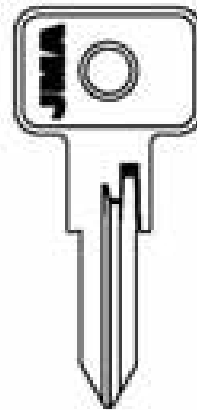

E-H
7001-8000
AF-14
ARMAN-CLAUSON
FIAT - M. MARILLI - NEUMAN - SEPE

PARA-FOR:

GHE (D)

GIOBERT (I)

PARA:
FOR:

GIOBERT

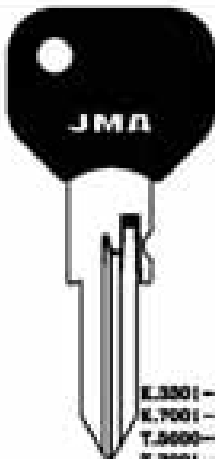

E-H
7001-8000
AF-14.P
ARMAN-CLAUSON
FIAT - M. MARILLI - NEUMAN - SEPE

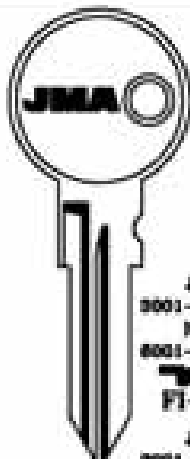

FI-1
3001-8732
8001-7000
AUTOMARCHI - FIAT - LANCIA
BAYTON - PIRELLI - STRIATE - PUCI
GAGLI - SILEA - FRASSO - TOSI



FI-1.P
3001-8732
8001-7000
AUTOMARCHI - FIAT - LANCIA
BAYTON - PIRELLI - STRIATE - PUCI
GAGLI - SILEA - FRASSO - TOSI

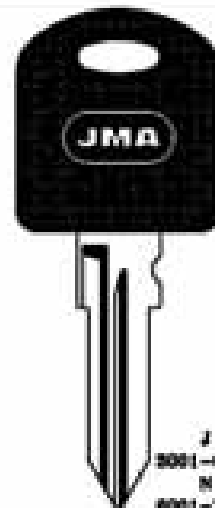

FI-1.PB
3001-8732
8001-7000

PARA:
FOR:

GIOBERT

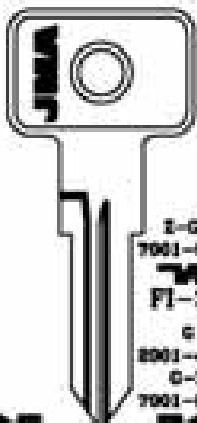

FI-3
I-GR
7001-8000
FI-2D
C
8001-4500
G-2
7001-8000
FI-3D
C
7001-8000
FI-12

A. BORGIO - AUTOMARCHI - CITROEN - FIAT
INNOCENTI - LANCIA - PEUGEOT - SEAT
7500 - SILEA - CAT - TOSI

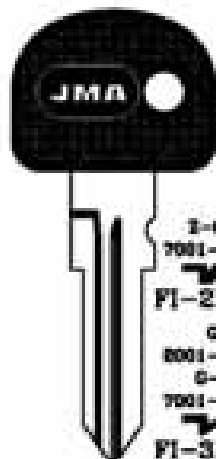

FI-2D.P3
I-GR
7001-8000
FI-2D
C
8001-4500
G-2
7001-8000
FI-3D.P3
C
7001-8000
FI-12.P3

A. BORGIO - AUTOMARCHI - CITROEN - FIAT
LANCIA - PEUGEOT - SEAT



FI-3D.P
ALFA ROMEO
CITROEN
FIAT
INNOCENTI
LANCIA
SEAT
7500 - SILEA
C
8001-4500
G-2
7001-8000
FI-3D.P
C
7001-8000
FI-12.P



FI-3D.P1
ALFA ROMEO
CITROEN
FIAT
INNOCENTI
LANCIA
SEAT
7500 - SILEA
C
8001-4500
G-2
7001-8000
FI-3D.P1
C
7001-8000
FI-12.P1

Copyright by
Algebra Alfas S.A.
1978

JMA



161

PARA-FOR:

GIOBERT (I)

PARA-FOR:
FOR:

GIOBERT

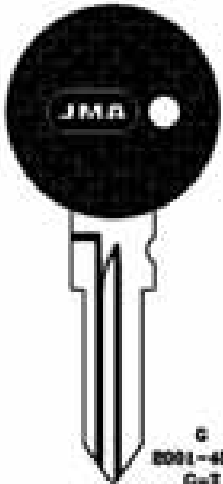

G
8001-4500
G-Z
7001-8000
FI-3D.P2
Fiat

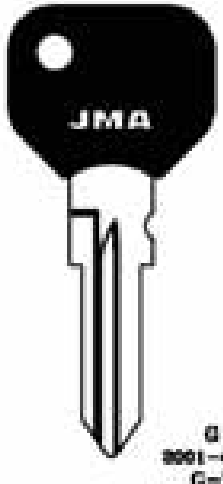

G
8001-4500
G-Z
7001-8000
FI-3D.P4
ALFA ROMEO

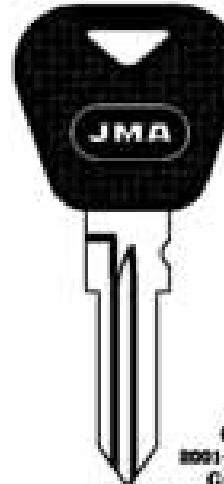

G
8001-4500
G-Z
7001-8000
FI-3D.P5
BMC/BENTON-PIAGG BARTOVA

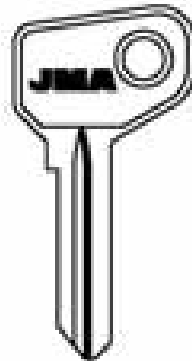

FI-4D
FI-5I
FI-5D
ON PISCO-PIAT PISCO
LANCIA

PARA-FOR:
FOR:

GIOBERT



ALFA ROMEO
AUTOMOBILE
CITROEN
FERRARI
FIAT
BMC/BENTON
LANCIA
PEUGEOT
PIAGG BARTOVA
LANCIA
BENTON
PIAGG BENTON
GARELLI
SUZUKI
FI-6I

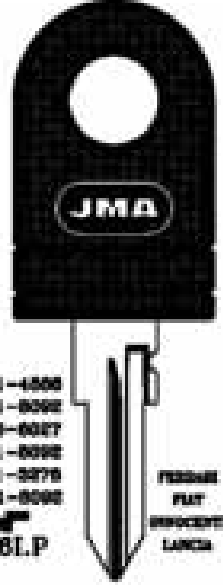

X 3301-4500
X 7001-8000
T 5000-8007
T 7001-8000
S 0501-3278
H 7001-8000
FI-6I.P

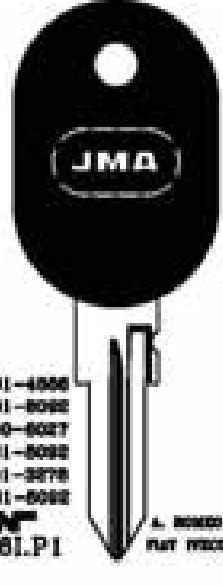

X 3301-4500
X 7001-8000
T 5000-8007
T 7001-8000
S 0501-3278
H 7001-8000
FI-6I.P1

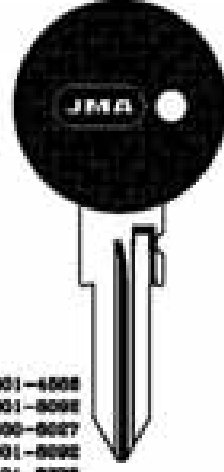

X 3301-4500
X 7001-8000
T 5000-8007
T 7001-8000
S 0501-3278
H 7001-8000
FERRARI
FIAT
LANCIA
FI-6I.P2

PARA-FOR:
FOR:

GIOBERT

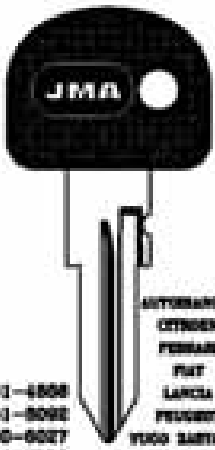

AUTOMOBILE
CITROEN
FERRARI
FIAT
LANCIA
PEUGEOT
PIAGG BARTOVA
LANCIA
BENTON
PIAGG BENTON
GARELLI
SUZUKI
FI-6I.P3



X 3301-4500
FI-7I
Fiat
NETMAN-BOPEA

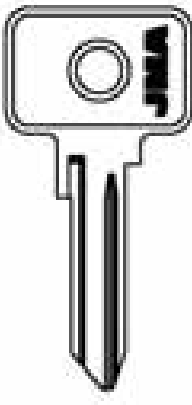

Y 7001-8000
FI-6I
AUTOMOBILE-PIAT-BENT
ARMAN

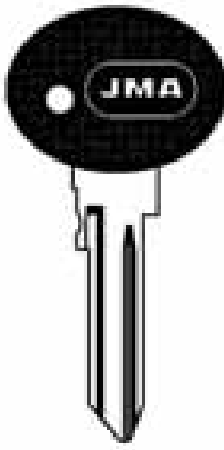

Y 7001-8000
FI-6I.P
AUTOMOBILE-PIAT-BENT
ARMAN

Copyright by
Alphonse Allier S.A.
1978



ATTENZIONE: Copiare e/o ristampare e distribuire informazioni contenute nel libro è vietato. ATTENTION: Copier et/ou réimprimer et distribuer des informations contenues dans ce livre est interdit. ATTENTION: Copiar e/o ristampare e distribuir informaciones contenidas nel libro e' vietado.

PARA:
FOR:

GIOBERT

PARA-FOR:

GIOBERT (I)

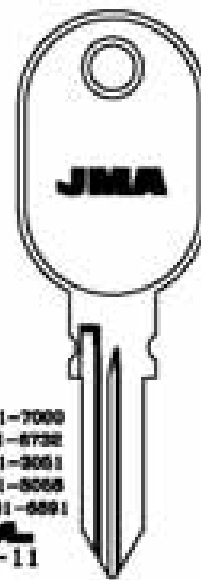
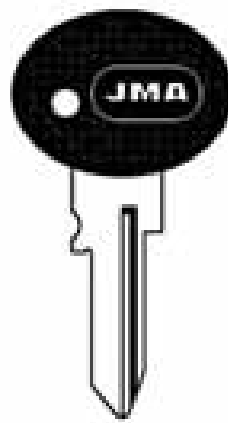

Y
7001-9999
FI-81.P1
FIAT-FIAT 1900
ARMAH

N
0001-1000
FI-91
ALFA ROMEO-AUTORAUCO-FIAT-LANCIA
OR 1900-942-9795 FIAT

N
0001-1000
FI-91.P

N 8001-7000
J 8001-8732
Y 8001-9001
V 8001-9008
AB 8001-9991
FI-11
AUTORAUCO-FIAT-IMPREGIATO-LANCIA
MAYOR FERRARI-STEEL-FIAT-ARMAH

PARA:
FOR:

GIOBERT

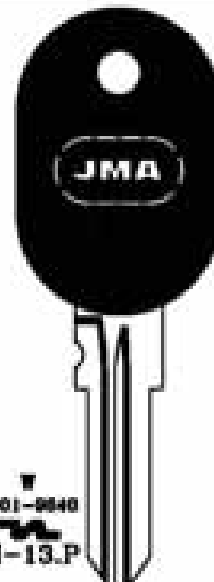
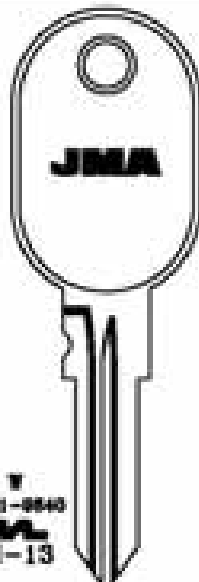
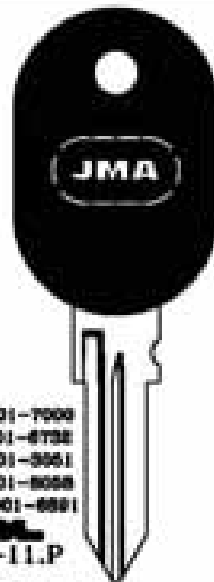

N 8001-7000
J 8001-8732
Y 8001-9001
V 8001-9008
AB 8001-9991
FI-11K.P

N 8001-7000
J 8001-8732
Y 8001-9001
V 8001-9008
AB 8001-9991
FI-11.P

V
0001-9940
FI-13

V
0001-9940
FI-13.P

AUTORAUCO-FIAT-IMPREGIATO-LANCIA
MAYOR FERRARI-STEEL-FIAT-ARMAH

ALFA ROMEO-FIAT-LANCIA

ALFA ROMEO-FIAT-LANCIA

PARA:
FOR:

GIOBERT

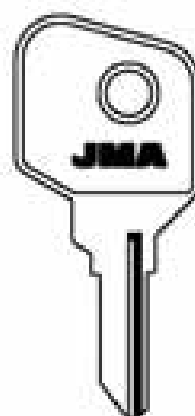
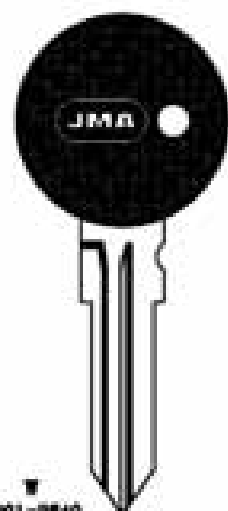
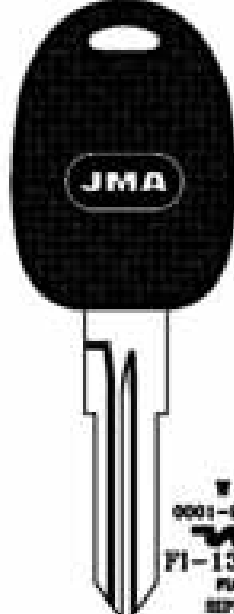
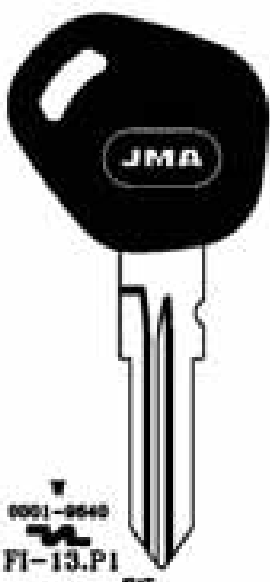

V
0001-9940
FI-13.P1
FIAT

V
0001-9940
FI-13.P7
FIAT
SEPLA

V
0001-9940
FI-14.P
ALFA ROMEO-FIAT-LANCIA

FI-15

Copyright by
Alejandro Allieria S.A.
2019

JMA



163











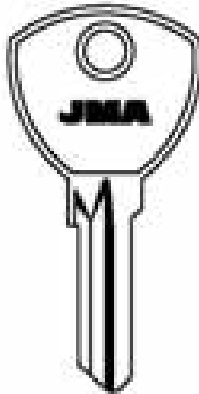

PARA-FOR:











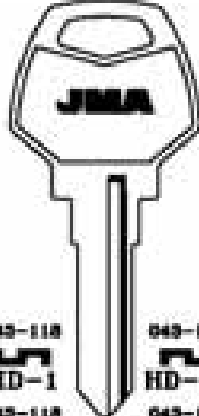

GIOBERT (I)



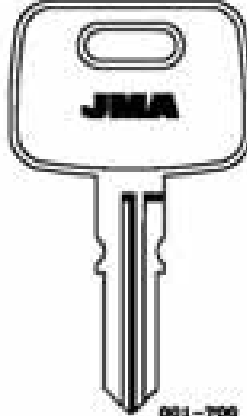

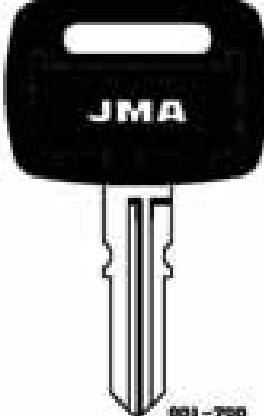

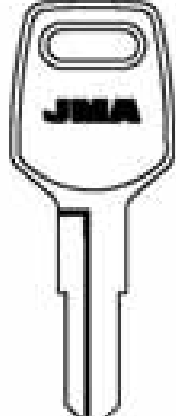

HAMA (D)

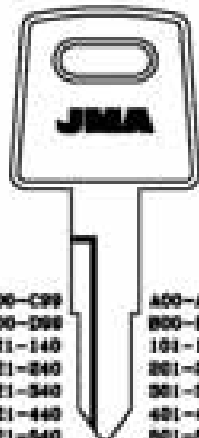
HARLEY DAV. (USA)

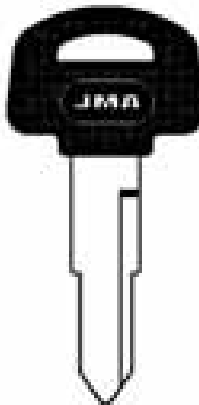
HONDA (J)

<p>PARA: FOR:</p>  <p> GIOB-1D</p> <p> GIOB-2I LAPCA-SABERATI</p>	<p>GIOBERT</p>  <p> GIOB-1D.P</p> <p> GIOB-2I.P LAPCA-SABERATI</p>	 <p>ALP. ALFA ROMEO LA FIORA LAPCA MAYOR FINISSE 9001-1000</p> <p> GIOB-3.P SAFE</p>	<p>HAMA</p>  <p></p> <p>761-762 776-768</p> <p> HA-1I  HA-1D</p> <p>FOR BLAU</p>
---	--	--	---

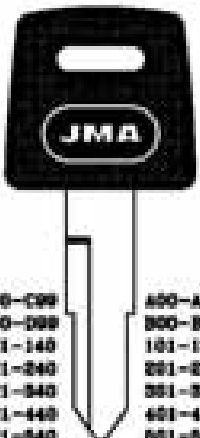
<p>PARA: FOR: HARLEY D.</p>  <p>043-118 043-118  HD-1  HD-1D</p> <p>043-118 043-118  HD-2  HD-2D</p> <p>043-118 043-118  HD-3  HD-3D</p> <p>HARLEY DAYTON</p>	<p>HONDA</p>  <p>001-700  HOND-1</p> <p>001-700  HOND-2</p> <p>HONDA-TELETYPE</p>	 <p>001-700  HOND-1.P</p> <p>001-700  HOND-2.P</p> <p>HONDA-TELETYPE</p>  <p>1 AL 4  HOND-3I  HOND-3D</p> <p>HONDA</p>
---	--	---

<p>PARA: FOR:</p>  <p>000-099 000-099 101-140 101-100 201-240 201-200 301-340 301-300 401-440 401-400 501-540 501-500 601-640 601-600 701-740 701-700 801-840 801-800</p> <p> HOND-4I  HOND-4D</p> <p>HONDA</p>	 <p>000-099 101-100 201-200 301-300 401-400 501-500 601-600 701-700 801-800</p> <p> HOND-25.P2</p> <p> HOND-30.P2  HOND-30D.P2</p> <p>HONDA</p>	 <p>000-099 000-099 101-140 101-100 201-240 201-200 301-340 301-300 401-440 401-400 501-540 501-500 601-640 601-600 701-740 701-700 801-840 801-800</p> <p> HOND-4I.P  HOND-4D.P</p> <p>HONDA</p>
---	--	--

Copyright by
Algebra Alfas S.A.
1978

JMA



PARA:
FOR:

HONDA

PARA-FOR:

HONDA (J)

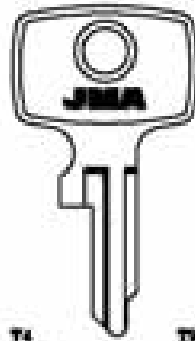
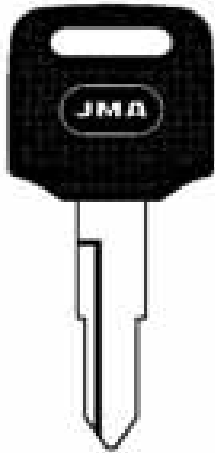

...C00-C09
 ...D00-D09
HOND-4I.P1
 HONDA

...400-499
 ...500-599
HOND-4D.P1
 HONDA

T4
HOND-5I
 T1 E AL B T5
 S AL B T6
HOND-5D
 HONDA

T3
HOND-6I
 T2
HOND-6D
 HONDA

T3
HOND-7I
 T2
HOND-7D
 HONDA

HOND-16.P
 HONDA

HOND-18D.P
 HONDA

HOND-8I
 HONDA

HOND-8D
 HONDA

PARA:
FOR:

HONDA

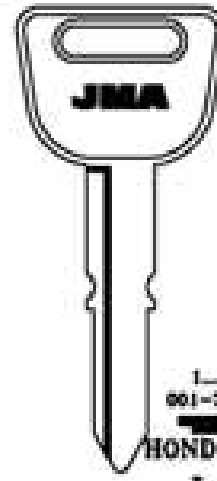
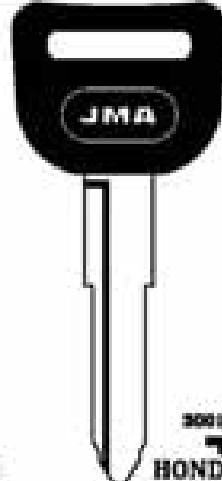
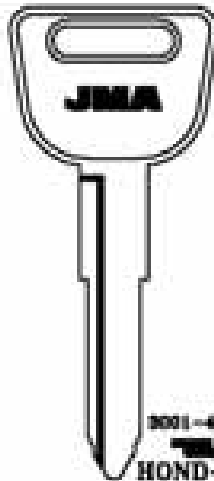
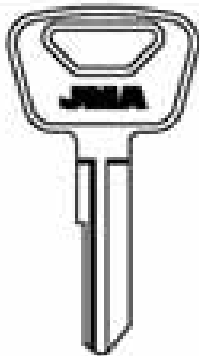

HOND-9I
HONDA

0001-4481
HOND-10
0001-4481
HOND-11
ACTIVA-BONDA-BONER

0001-4481
HOND-10.P
0001-4481
HOND-11.P
ACTIVA-BONDA-BONER

001-700
HOND-12
001-700
HOND-13
HONDA

PARA:
FOR:

HONDA

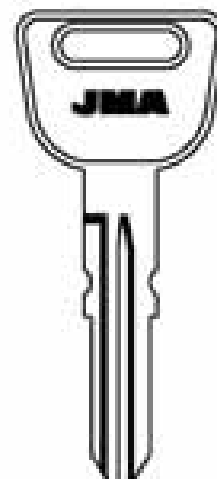
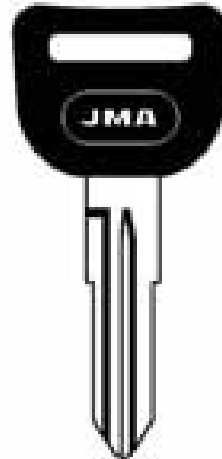
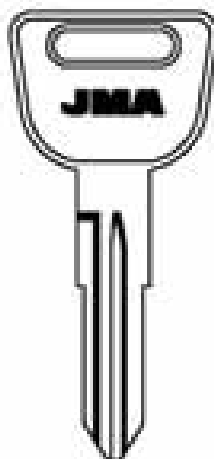
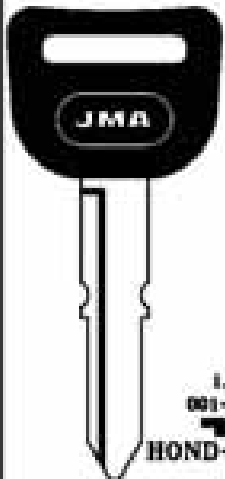

001-700
HOND-12.P
001-700
HOND-13.P
HONDA

0001-8442
HOND-14
HONDA

0001-8442
HOND-14.P
HONDA

0001-8442
HOND-15
ACTIVA-BONDA

Copyright by
Algebra Almas S.A.
2018

JMA



165

PARA-FOR:

HONDA (J)

PARA-FOR:

HONDA

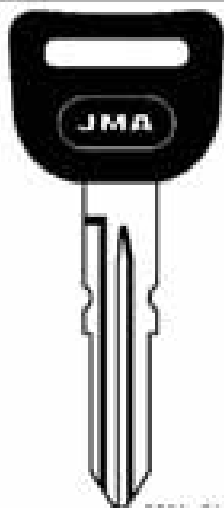

5001-5442

HOND-15.P

ACTRA-HONDA

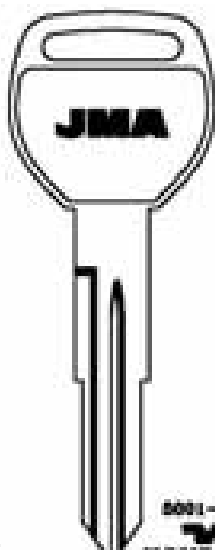

5001-5442

HOND-16D

ACTRA-HONDA

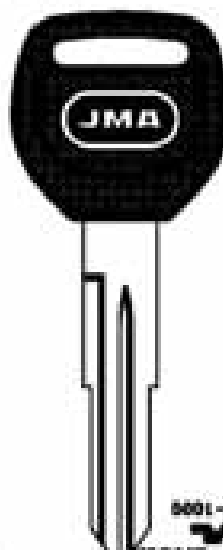

5001-5442

HOND-16D.P

ACTRA-HONDA

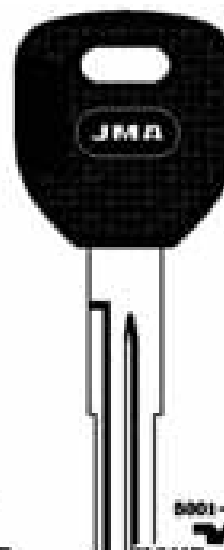

5001-5442

HOND-16D.P

ACTRA-HONDA

PARA-FOR:

HONDA

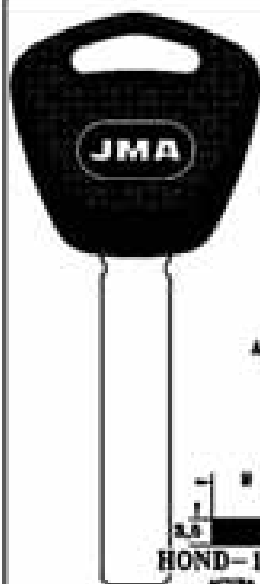

ALP.



HOND-17.P

ACTRA

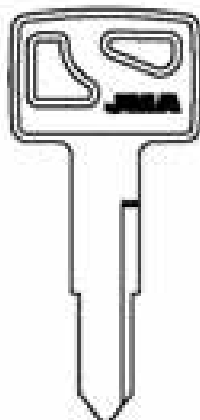

...100-199

...300-399

...C00-C99

...D00-D99

HOND-19

HONDA

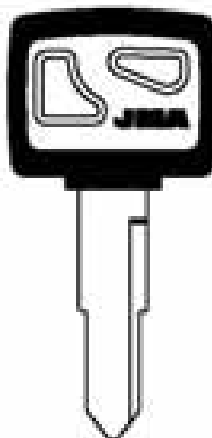

...100-199

...300-399

...C00-C99

...D00-D99

HOND-19.P

HONDA

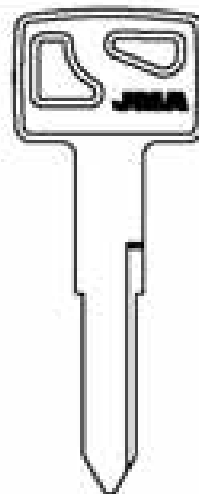

.....1 AL 3

...100-199

HOND-20

HONDA

PARA-FOR:

HONDA

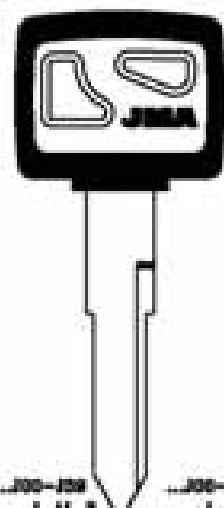

...100-199

.....1 AL 3

HOND-20.P

HONDA

...100-199

.....1 AL 3

HOND-20D.P

HONDA

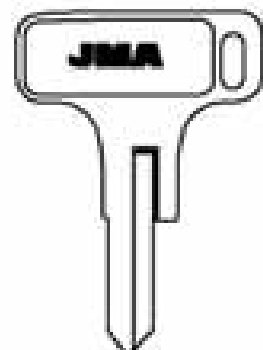

300-344

.....0-7-8-9

HOND-21

HONDA

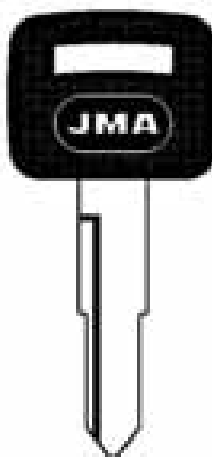

HOND-22D.P

HONDA

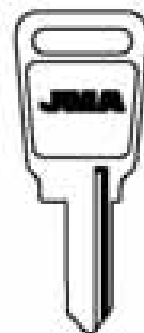

HOND-23

Copyright by
Algebra Altes S.A.
1978

JMA



166

PARA: **HONDA**
 FOR:

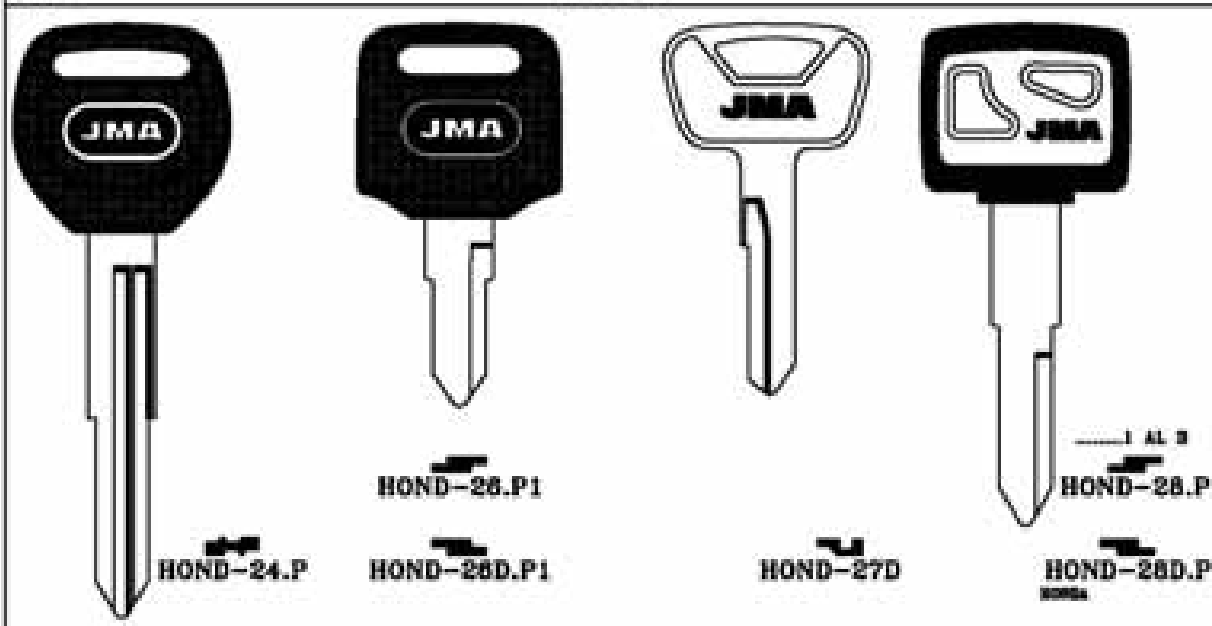

PARA-FOR:

HONDA (J)
HUDSON (USA)
HUF (D)

PARA: **HONDA**
 FOR:

HUDSON

HUF

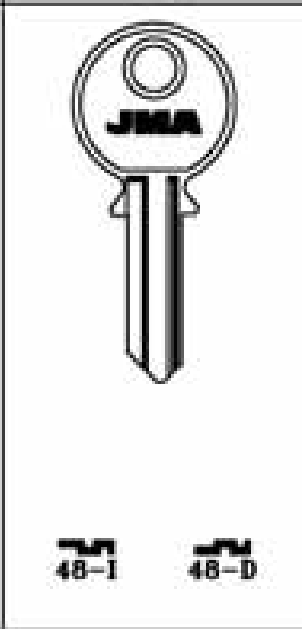
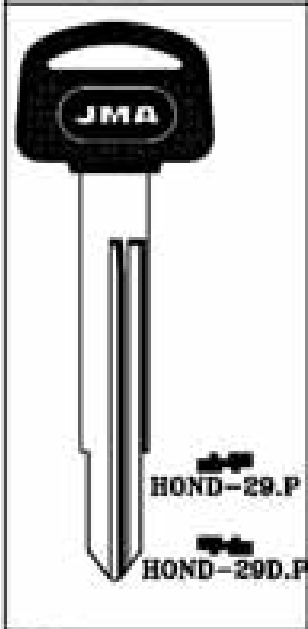

PARA: **HUF**
 FOR:

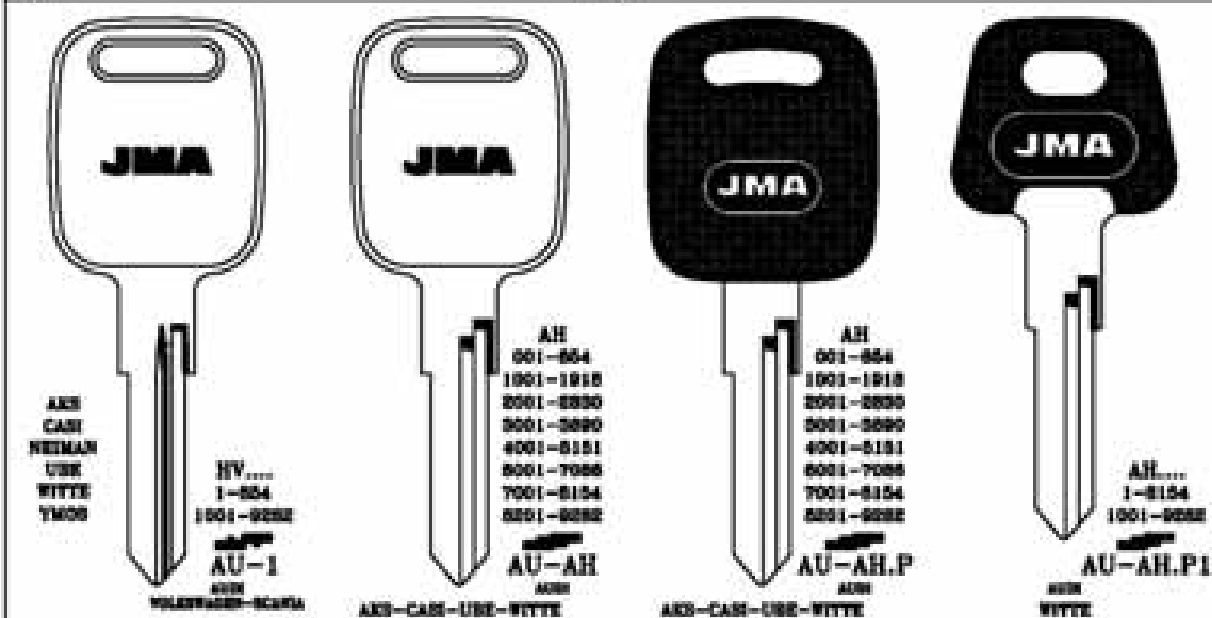

Copyright by
 Alejandro Altuna S.A.
 2008

167

PARA-FOR:

HUF (D)

PARA-FOR: **HUF**

AN
001-804
1001-1818
2001-2800
3001-3800
4001-5181
6001-7088
7001-8184
8001-9088

AU-AN
AUX-VOLFRAGEN
AUS-CAS-USE-WITTE

AN
001-804
1001-1818
2001-2800
3001-3800
4001-5181
6001-7088
7001-8184
8001-9088

AU-AN.P
AUX-FORD-PORSCHE-VOLFRAGEN
AUS-CAS-USE-WITTE

C
01-02/01-02

AU-C
AUX
AUS

AUS CAS NEUMAN USE WITTE YMOB

HV....
1-804
1001-8088

AU-HV
AUX-VOLFRAGEN-SCARLA

PARA-FOR: **HUF**

AUS CAS NEUMAN USE WITTE YMOB

HV....
1-804
1001-8088

AU-HV.P
AUX-VOLFRAGEN-SCARLA

AUS CAS NEUMAN USE WITTE YMOB

HV....
1-804
1001-8088

AU-HV.P1
AUX

W
11-01/11-01

AU-W
AUX-VOLFRAGEN
AUS-WITTE

7.48
8.7
BM-1.P

HV
PERRA

AUX

0001-1180

PARA-FOR: **HUF**

HV
10001-20000
40001-48000

BM-2
HUF

HV
10001-20000
40001-48000

BM-2.P
HUF

HV
1-5000

BM-3
HUF

HV
1-5000

BM-3.P
HUF

Copyright by
Algebra Altim S.A.
1818

JMA



PARA:
FOR:

HUF

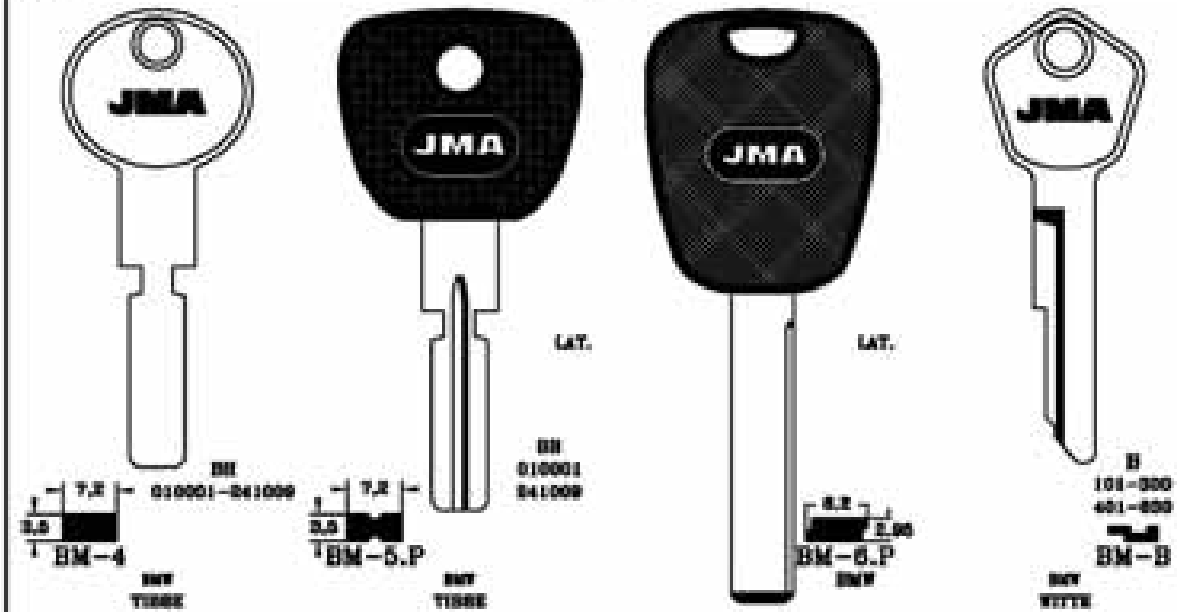

PARA-FOR:

HUF (D)

PARA:
FOR:

HUF

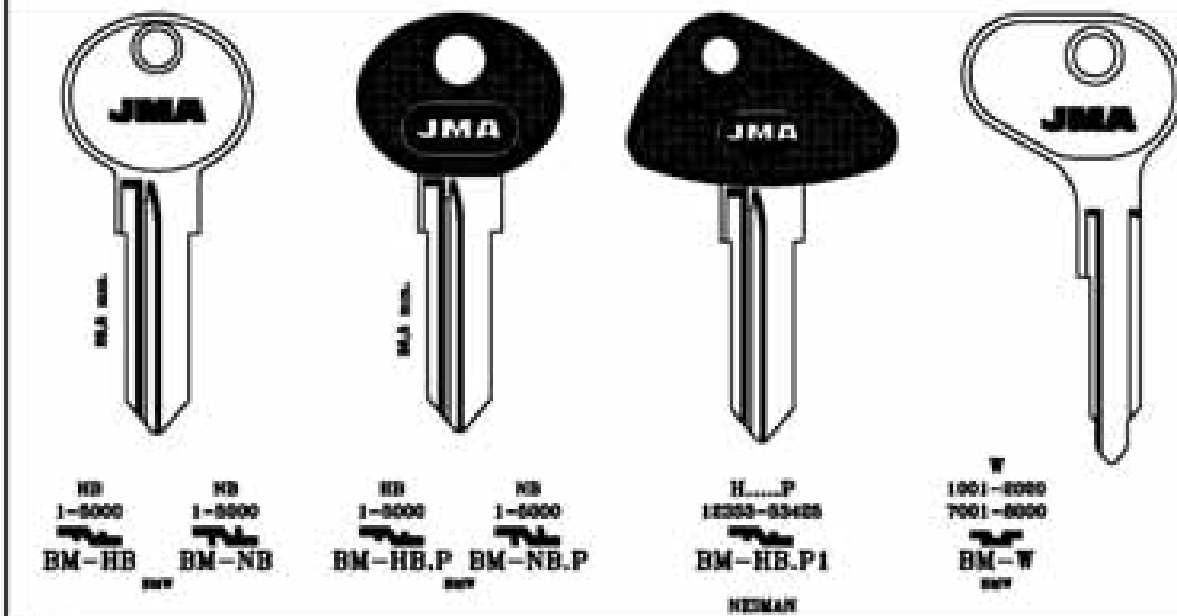

PARA:
FOR:

HUF

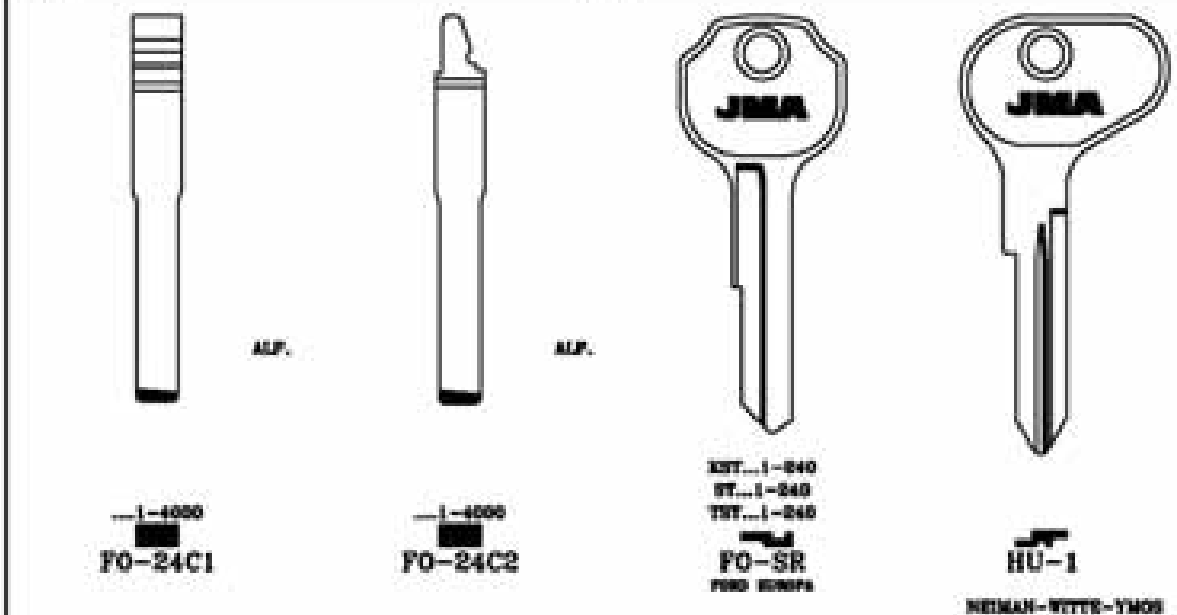

Copyright by
Aljeandre Almon S.A.
2010

JMA



169

PARA-FOR:

HUF (D)

PARA-FOR: HUF

ALP.
HU-2.P
SCARIA
1-2000
7,8
3,8

AN
001-804
1001-1818
2001-3000
3001-3800
4001-8181
5001-7088
7001-8154
801-9002
HUF
HU-AN
VILLAGGIO
AUS-CAD-USE-WITTE

DF-F
0001-1875
HUF
HU-DF
VILLAGGIO

DF-F
0001-1875
HUF
HU-DF.P
VILLAGGIO

PARA-FOR: HUF

DF-F
0001-1875
HUF
HU-DF.P1
VILLAGGIO

LAT.
HU-DH.P
VILLAGGIO
DH-08
8001-8000
7,8
3,45

LAT.
HU-DN.P
VILLAGGIO
DH-08
8001-8000
7,8
3,45

ALP.
HU-HAAC1
VILLAGGIO

PARA-FOR: HUF

ALP.
HU-HAAC2
VILLAGGIO

LAT.
HU-HAA.P1
VILLAGGIO
8,17

ALP.
HU-MN
VILLAGGIO
80
81-82
MN
0001-1000

ALP.
HU-MN.P
VILLAGGIO
80
81-82
MN
0001-1000

Copyright by
Alphonse Allotta S.A.
1978

JMA



170

PARA:
FOR:

HUF



P
001-848
HU-P

Y50

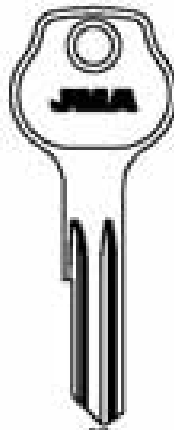

SE
001-790
SC
401-830

HU-SC

SEB-SAM-POBCKE-OTYTS POCZ-VOLZTRAGEN-SCARLA

AKZ

SE
001-840
ESR
001-840
LSR
001-840
TBR
001-840
HU-SR



SE
1-840

HU-SZ

SU
001-848
401-830
HU-SU

SE
001-848
HU-SX

SY
001-840
HU-SY

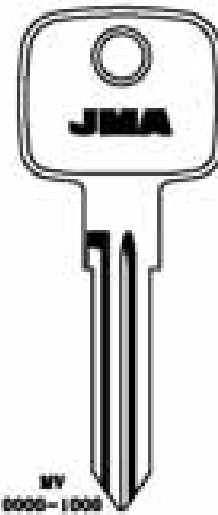

MY
0000-1000
ME-1

REINIGEN
CLAUSUR

PARA-FOR:

HUF (D)

PARA:
FOR:

HUF

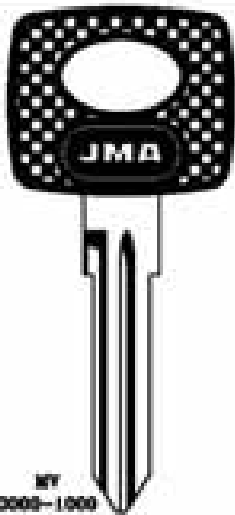

MY
0000-1000
ME-1.P

REINIGEN
CLAUSUR

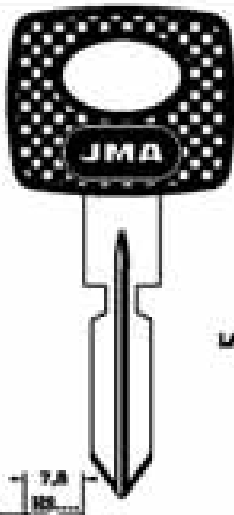

7.8
ME-2.P

REINIGEN
TMOZ

LAT.

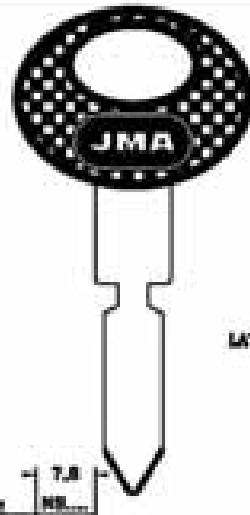

7.8
ME-3.P

REINIGEN
TMOZ

LAT.

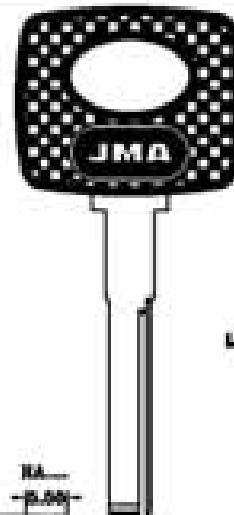

8A
-5.00
ME-4.P

REINIGEN
TMOZ

LAT.

PARA:
FOR:

HUF

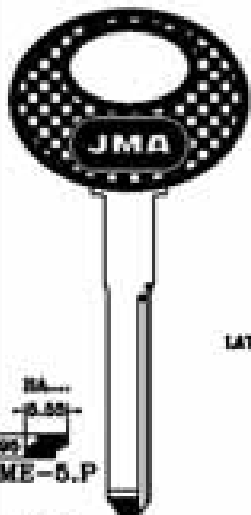

8A
-5.00
ME-6.P

ME-6.P

REINIGEN
TMOZ

LAT.

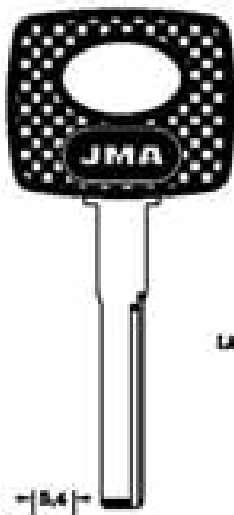

8.4
ME-7.P

ME-7.P

REINIGEN
TMOZ

LAT.

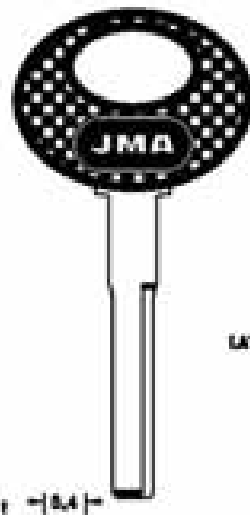

8.4
ME-8.P

ME-8.P

REINIGEN
TMOZ

LAT.

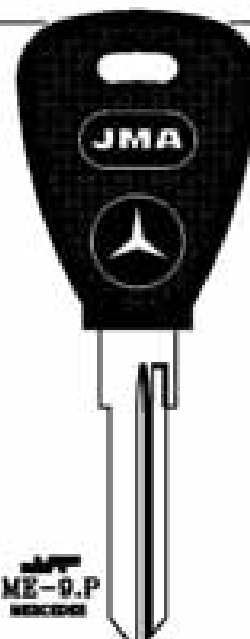

ME-9.P

REINIGEN

Copyright by
Alejandro Alonso S.A.
2018

JMA

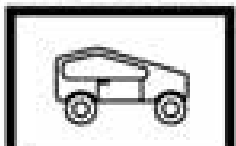

171

PARA-FOR:

HUF (D)

HUF

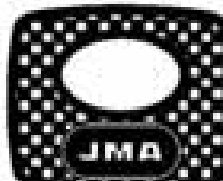

LAT.

NA
-0.55
E.SS
ME-10.P

NA
ME-11.P

YMOB

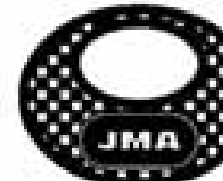

LAT.

NA
-0.4
E.SS
ME-12.P

YMOB



TX

ME-13D.P

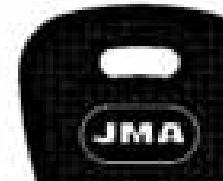

ME-14.P

YMOB

HUF

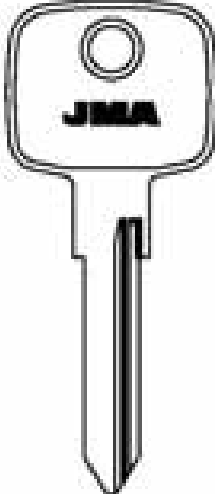

ME-HD

ME-HZ

YMOB

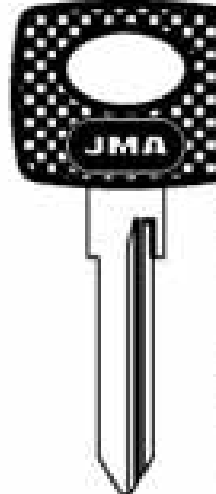

ME-HF

ME-HM

YMOB

<p>HD 4001-7300</p> <p>NZ 0001-1400</p> <p>NZ 0001-0500</p> <p>NZ 1-99/1-99</p> <p>ME-HD</p> <p>HZ 0001-1400</p> <p>HZ 0001-0500</p> <p>HZ 4001-0500</p> <p>HD</p> <p>4001-0795</p> <p>0001-7300</p> <p>NZ 1-99/1-99</p> <p>ME-HZ</p> <p>YMOB</p>	<p>..NF..</p> <p>1-99/1-99</p> <p>NF 0001-1200</p> <p>NM...</p> <p>0001-1200</p> <p>4001-7300</p> <p>ME-HF</p> <p>NM 0001-1200</p> <p>0001-0500</p> <p>4001-0795</p> <p>0001-7300</p> <p>NF 0001-1200</p> <p>..NF..</p> <p>1-99/1-99</p> <p>ME-HM</p> <p>YMOB</p>	<p>..NF..</p> <p>1-99/1-99</p> <p>NF 0001-1200</p> <p>NM...</p> <p>0001-1200</p> <p>4001-7300</p> <p>ME-HF.P</p> <p>NM 0001-1200</p> <p>0001-0500</p> <p>4001-0795</p> <p>0001-7300</p> <p>NF 0001-1200</p> <p>..NF..</p> <p>1-99/1-99</p> <p>ME-HM.P</p> <p>YMOB</p>
---	---	---

HUF

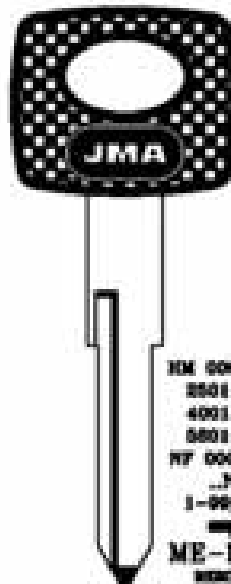

ME-HML.P

YMOB

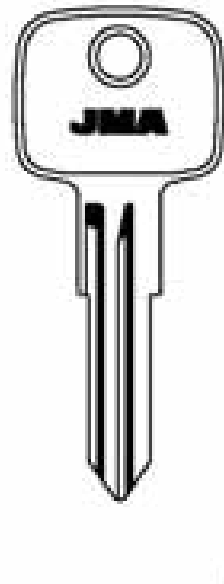

ME-HU

ME-NU

YMOB

<p>NM 0001-1200</p> <p>0001-0500</p> <p>4001-0795</p> <p>0001-7300</p> <p>NF 0001-1200</p> <p>..NF..</p> <p>1-99/1-99</p> <p>ME-HML.P</p> <p>YMOB</p>	<p>HU</p> <p>0001-0130</p> <p>ME-HU</p> <p>HU</p> <p>0001-0130</p> <p>ME-NU</p> <p>YMOB</p>	<p>HY</p> <p>0001-0130</p> <p>ME-HY</p> <p>HY</p> <p>0001-0130</p> <p>ME-NY</p> <p>YMOB</p>
---	---	---

Copyright by
Allegre Allans S.A.
2018

JMA



172

PARA:
FOR:

HUF

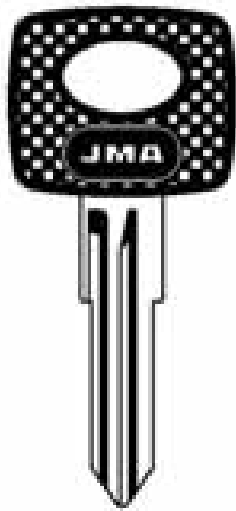

HU
0001-8130
ME-HU.P

NU
0001-8130
ME-NU.P

MECROSS
YMO5

HY
0001-8130
ME-HY.P

NY
0001-8130
ME-NY.P

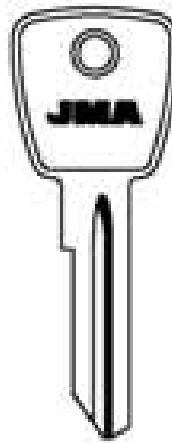

L
001-300
ME-L
MECROSS
YMO5-YMO8

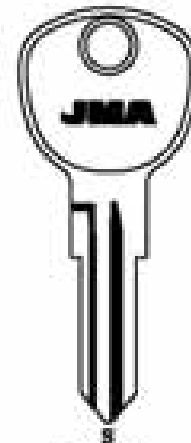

S
101-295
401-455
501-695
ME-S
MECROSS
CAS1

PARA-FOR:

HUF (D)

PARA:
FOR:

HUF

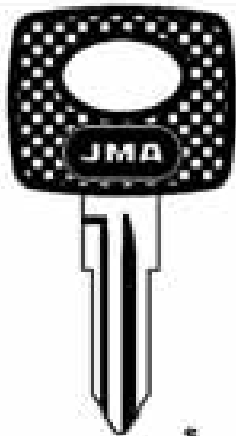

S
101-295
401-455
501-695
ME-S.P
MECROSS
CAS1

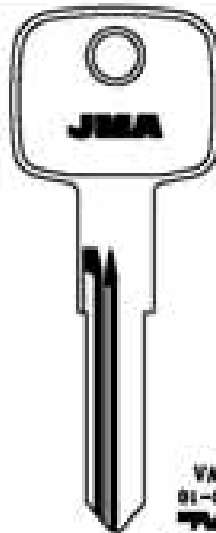

VA
01-50
ME-VA
MECROSS
CAS1

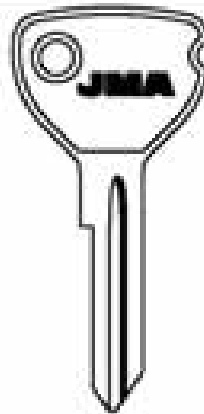

OP-1



6
001-250
OP-6
7
001-250
OP-7
8
001-250
OP-8
9
001-250
OP-9
MECROSS-OP6L-TAHERALL
YMO5

PARA:
FOR:

HUF



ALP.

Z...1-8000
Z...2001-4000
Z...4001-8000
OP-11C1

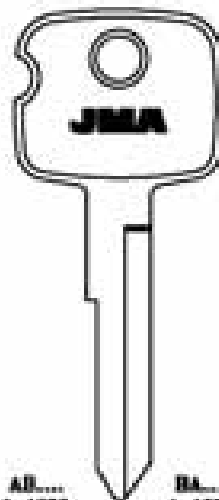

AB... 1-1000
OP-AB
BA... 1-1000
OP-BA
MECROSS-OP6L-TAHERALL
YMO5

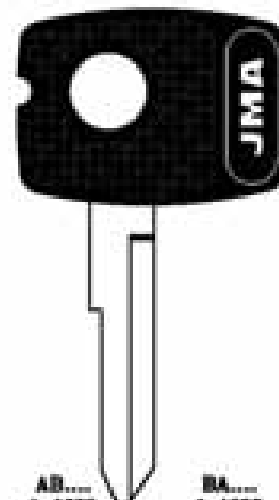

AB... 1-1000
OP-AB.P
BA... 1-1000
OP-BA.P
MECROSS-OP6L-TAHERALL
YMO5

Copyright by
Alpine Alfas S.A.
2018

JMA



173

PARA-FOR:

HUF (D)

PARA-FOR: **HUF**

	CC...501-1000 CC...1751-2000 CC...2501-3000	EE...501-1000 EE...1751-2000 EE...2501-3000	BB...501-1000 BB...1751-2000 BB...2501-3000		FF...501-1000 FF...1751-2000 FF...2501-3000	D 1-5000	S... 1-5000	D 1-5000	S... 1-5000
	OP-CC	OP-EE	OP-DD		OP-FF	OP-D	OP-S	OP-DK.P	OP-SK.P
E...1-500 BB...501-1000 EE...1751-2000 EE...2501-3000	BAZROO-OPEL-TACRALL					BAZROO-CH-LOTUS-OPEL-TACRALL		BAZROO-CH-LOTUS-OPEL-TACRALL	
						TMOS		TMOS	

PARA-FOR: **HUF**

	A... 1-500	E... 1-500			A... 1-500	E... 1-500	G...1-500 G...1251-1500	H...1-500 H...1251-1500	J... 1-2574
	OP-HA	OP-HB			OP-NA	OP-NB	OP-HG	OP-HH	OP-J
D 1-5000	BAZROO-CH-LOTUS-OPEL-TACRALL				OPEL-TACRALL		OPEL-TACRALL		BAZROO-VALEO-OPEL-TACRALL
									TMOS

PARA-FOR: **HUF**

	J... 1-2574	R... 1-1500	R... 1-1500	S... 1-5000
	OP-J.P	OP-R	OP-R.P	OP-S.P1
	BAZROO-VALEO-OPEL-TACRALL	CH-EMERSON-OPEL-TACRALL	CH-EMERSON-OPEL-TACRALL	BAZROO

Copyright by
Alfa Romeo S.p.A.
1978

JMA



174

PARA:
FOR:

HUF



T...
1-500
501-1500



OP-T

OM-EMERGED-OPEL-VAGHALL

YMOE

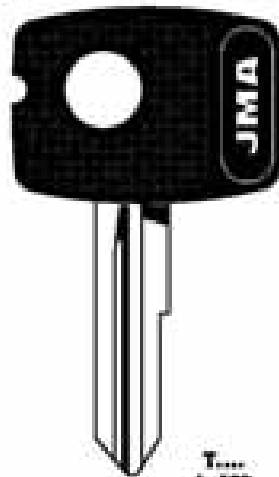

T...
1-500
501-1500



OP-T.P

OM-EMERGED-OPEL-VAGHALL

YMOE



H...
WH...
0001-3000



OP-WBC1

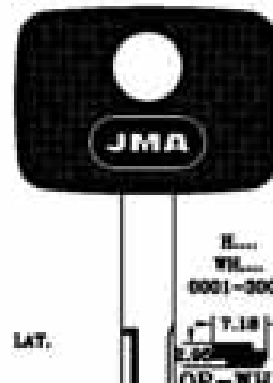

H...
WH...
0001-3000

7.18

OP-WH.P

WY...
Y...
0001-3000

8.08

OP-WY.P

ALP. LAT.

ANTON BLAUER
ON
BOLZEN
EMERGED
OPEL
VAGHALL

YMOE

PARA-FOR:

HUF (D)

PARA:
FOR:

HUF

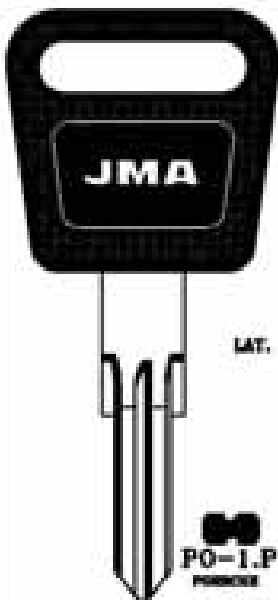

LAT.



PO-1.P

FORNICE

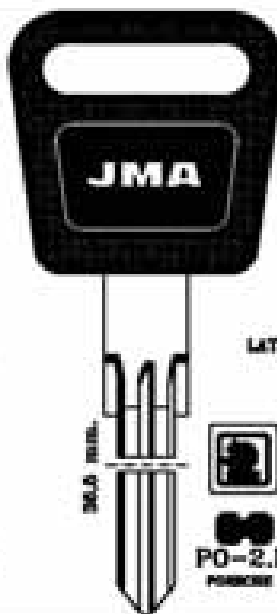

LAT.

EMERGED



PO-2.P

FORNICE

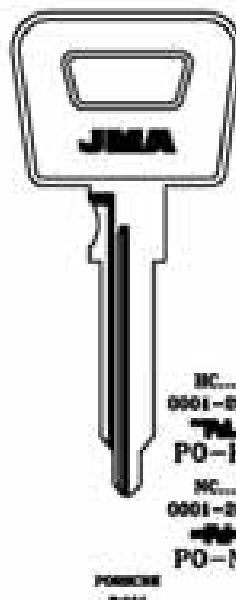

HC...
0001-2000



PO-HC

NC...
0001-2000



PO-NC

FORNICE
DOM

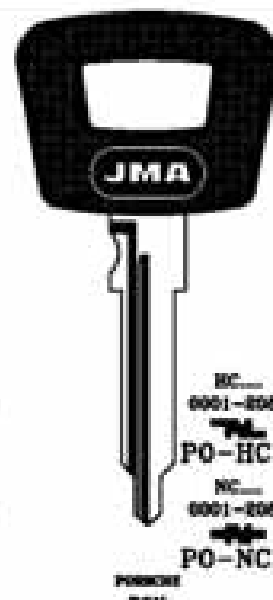

HC...
0001-2000



PO-HC.P

NC...
0001-2000



PO-NC.P

FORNICE
DOM

PARA:
FOR:

HUF

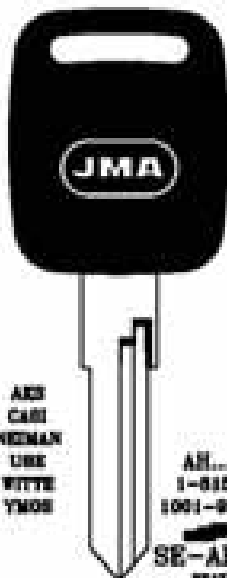

ACB
CARI
NEEMAN
USE
WITTE
YMOE

AH...
1-5154
1001-2000



SE-AH.P

SEAT

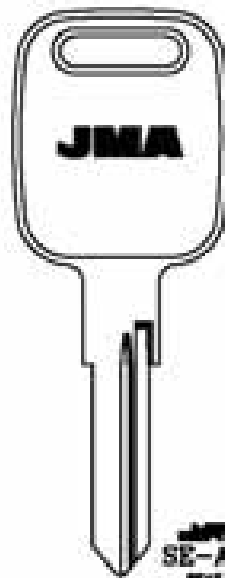

SE-AN

SEAT

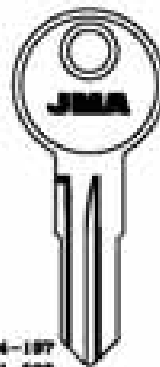

...184-197
...501-590
...701-790
...008-510
...001-100
A...101-105
A...701-790
C...001-100



VO-1

PLAT FIBRO
NEEMAN

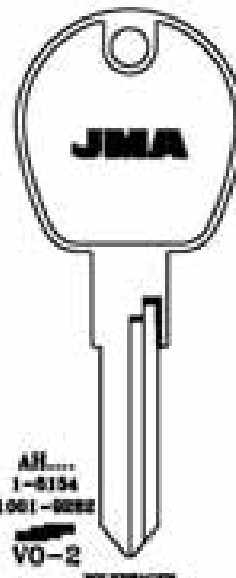

AH...
1-5154
1001-2000



VO-2

TELEFONEN
ACB-CARI-USE-WITTE

Copyright by
Alpine Alcoa S.A.
2010



175

PARA-FOR:

HUF (D)

HUF



AR...
1-8154
1001-9252

VO-2K.P

HV...
1-8154
1001-9252

VO-3K.P

VO-4K.P

VOLFRAGEN

AKS-CAS-USE-WITTE

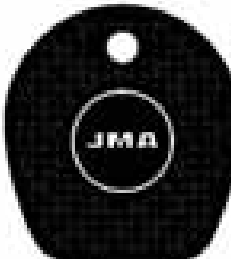

AR...
1-8154
1001-9252

VO-2.P

HV...
1-8154
1001-9252

VO-8.P

VOLFRAGEN

AKS-CAS-USE-WITTE

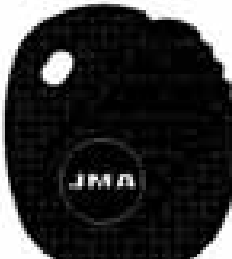

AR...
1-8154
1001-9252

VO-2D.P

VO-2.P1

VO-8.P1

HV...
1-8154
1001-9252

VO-8.P1

VOLFRAGEN

MASS

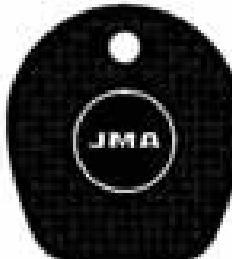

AN...
001-804
1001-1918
2001-2530
3001-3690
4001-5151
5001-7088
7001-8154
8001-9252

VO-5.P

CAS-BUF-USE-WITTE

HUF

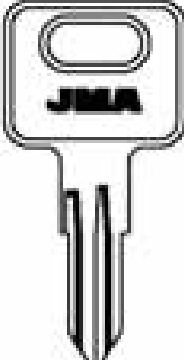

VO-8D

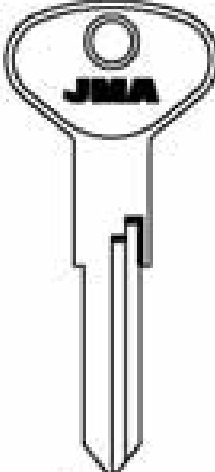

AR...
1-8154
1001-9252

VO-AH

HV...
1-8154
1001-9252

VO-HV

VB-NV-MD...
1-8154
1001-9252

VO-VB

N...
VO-N

AKS-FORS-FORCES-VOLFRAGEN

AKS-CAS-USE-WITTE

AN...
001-804
1001-1918
2001-2530
3001-3690
4001-5151
5001-7088
7001-8154
8001-9252

AU-AN

HUF

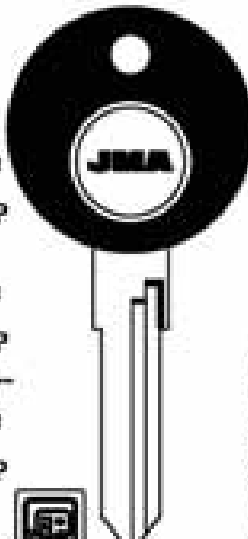

AR...
1-8154
1001-9252

VO-AH.P

HV...
1-8154
1001-9252

VO-HV.P

VB-NV-MD...
1-8154
1001-9252

VO-VB.P

N...
VO-N.P

AKS-FORS-FORCES-VOLFRAGEN

AKS-CAS-USE-WITTE

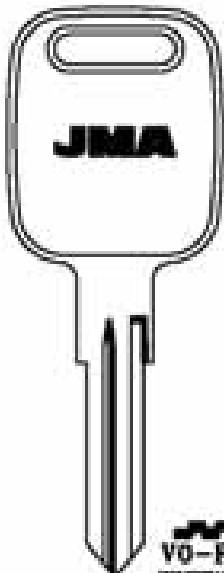

VO-FH

VOLFRAGEN

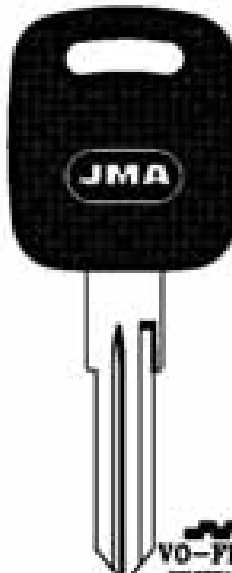

VO-FH.P

VOLFRAGEN

Copyright by
Alejandro Allina S.A.
2018

JMA

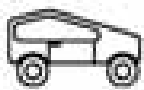

176

PARA:
FOR:

HUF

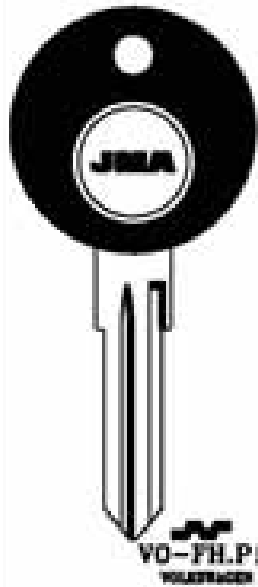

VO-FH.P1
VOLKSWAGEN

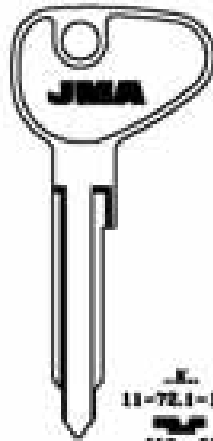

11-7E.1-110
VO-K

11-7E.1-110
VO-L

VOLKSWAGEN
REIMAN-BITTE

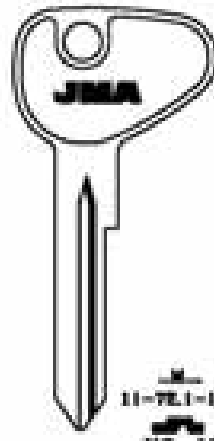

11-7E.1-110
VO-M



11-7E.1-110
VO-R

MAN-VOLKSWAGEN
AGS-CASI-BITTE



11-7E.1-110
VO-M.P

11-7E.1-110
VO-R.P

MAN-VOLKSWAGEN
AGS-CASI-BITTE

PARA-FOR:

HUF (D)

HUWIL (D)

HYUNDAI (K)

PARA:
FOR:

HUF

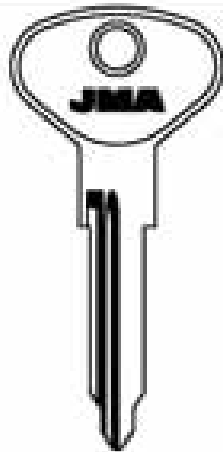

..VA..
01-00
VO-VA

VOLKSWAGEN

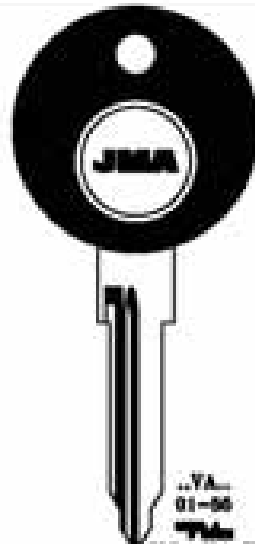

..VA..
01-00
VO-VA.P

VOLKSWAGEN

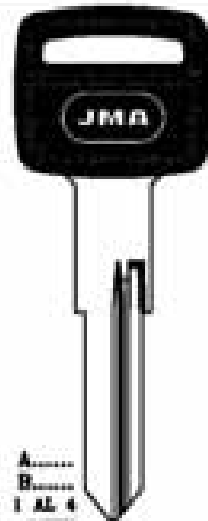

A.....
B.....
1 AL 4
VO-VB.P1

REIMAN

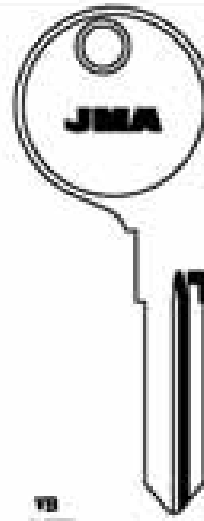

VO
VW-K70

PARA:
FOR:

HUWIL

HYUNDAI

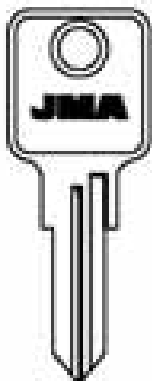

3000-4000
A
3001-4000
HUW-1 HUW-1D

STRAPOR-STEELCASE

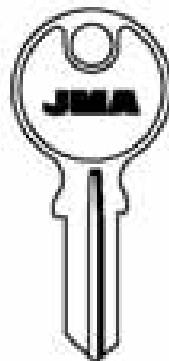

N
0000-1070
N
2001-2204
HUW-N

TECNO

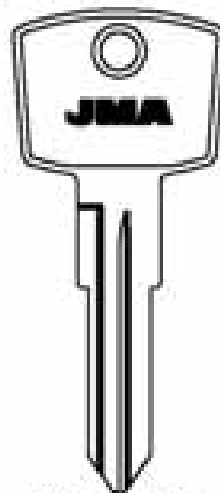

A/L... 0111-0300
HY-1

HYUNDAI

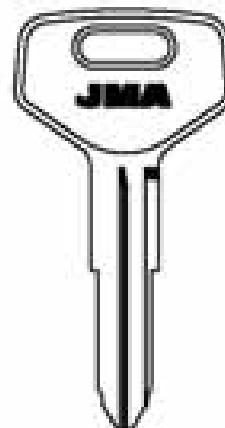

Y
1001-2000
HY-2

HYUNDAI

Copyright by
Allegretto Altesa S.A.
2010

JMA



177

PARA-FOR:

HYUNDAI (K)

PARA-FOR:

HYUNDAI

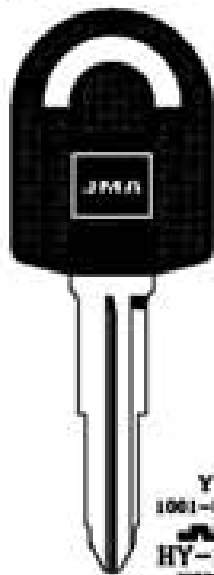

Y
1001-2000
HY-2.P
HYUNDAI

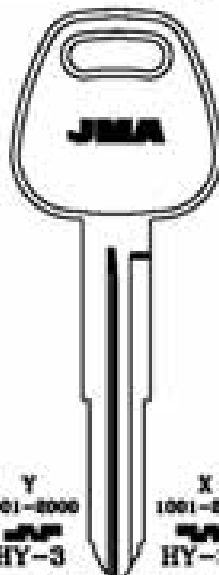

Y
1001-2000
HY-3
HYUNDAI

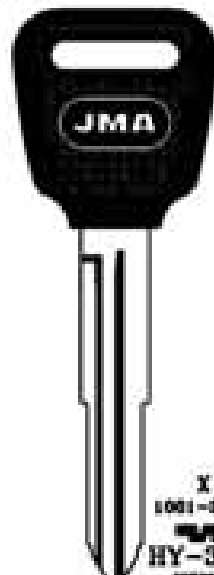

X
1001-2000
HY-3D.P
HYUNDAI

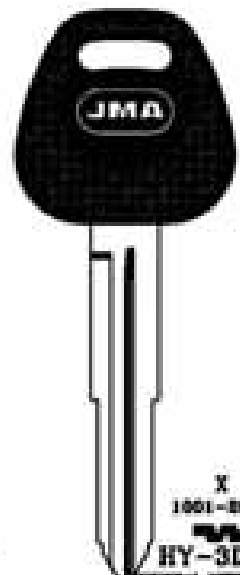

X
1001-2000
HY-3D.P1
HYUNDAI

PARA-FOR:

HYUNDAI

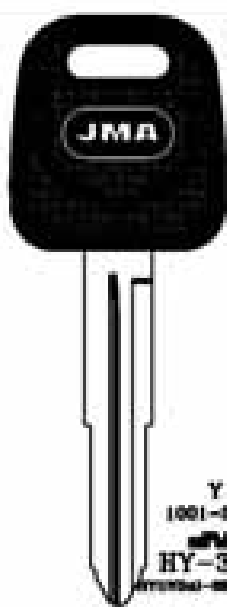

Y
1001-2000
HY-3.P2
HYUNDAI

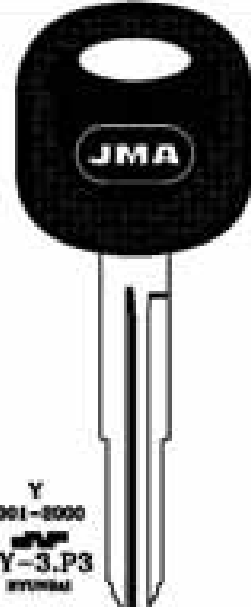

Y
1001-2000
HY-3.P3
HYUNDAI

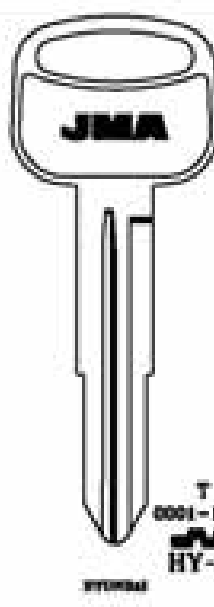

T
0001-1000
HY-4
HYUNDAI

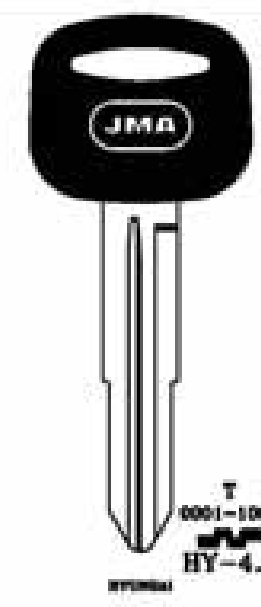

T
0001-1000
HY-4.P
HYUNDAI

PARA-FOR:

HYUNDAI

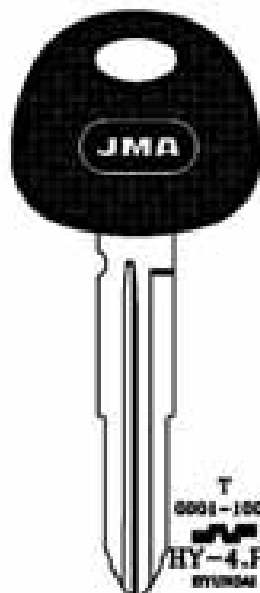

T
0001-1000
HY-4.P2
HYUNDAI

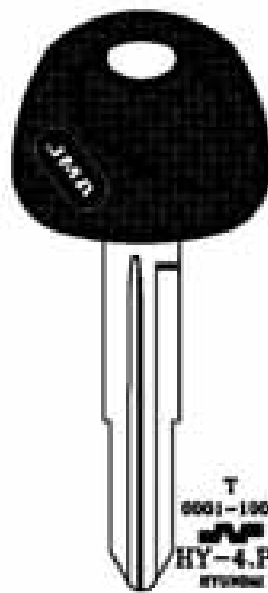

T
0001-1000
HY-4.P3
HYUNDAI

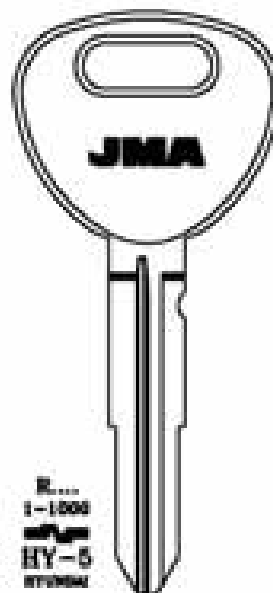

R...
1-1000
HY-5
HYUNDAI

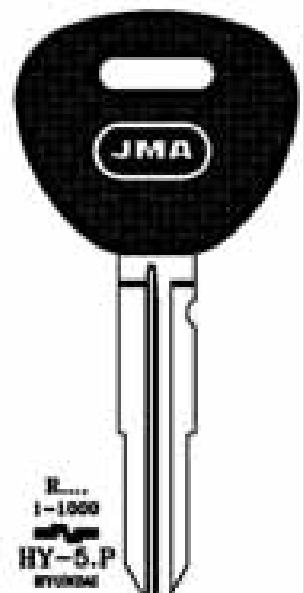

R...
1-1000
HY-5.P
HYUNDAI

Copyright by
Alpex S.p.A. S.p.A.
1978

JMA



178

PARA:
FOR:

HYUNDAI

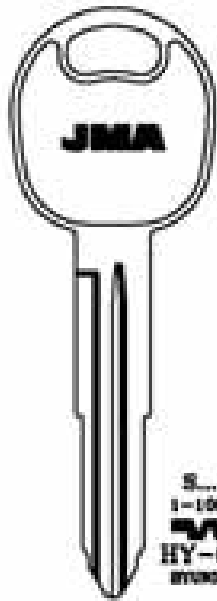

S...
1-1000

HY-6D
HYUNDAI

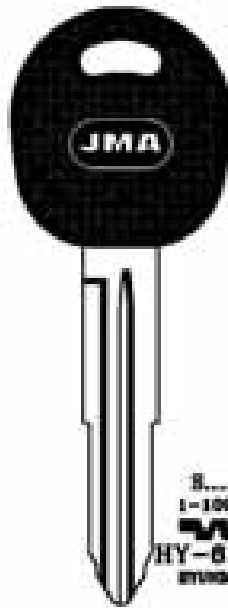

S...
1-1000

HY-6D.P
HYUNDAI

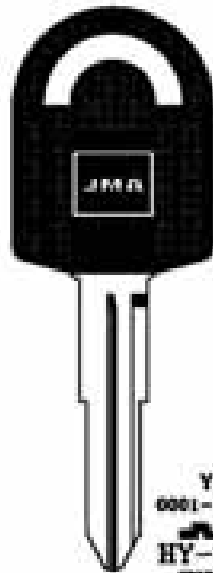

Y
0001-1000

HY-7.P
HYUNDAI

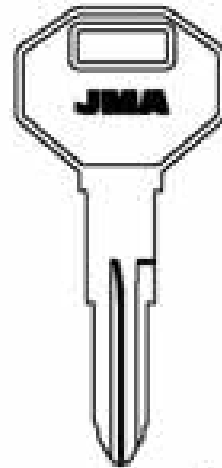

H
1-2000

HY-8
HYUNDAI

PARA:
FOR:

HYUNDAI

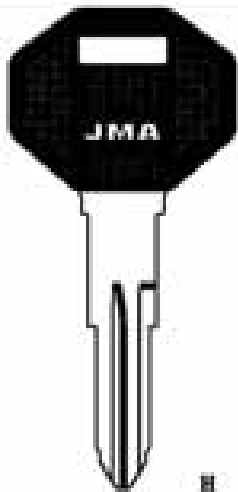

H
1-2000

HY-8.P
HYUNDAI

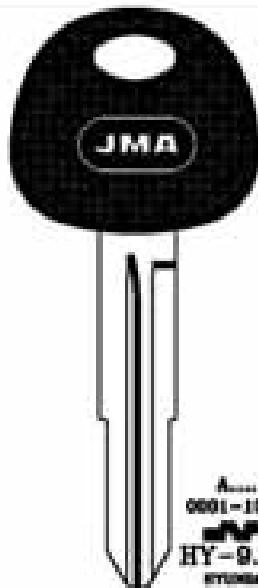

A...
0001-1000

HY-9.P2
HYUNDAI

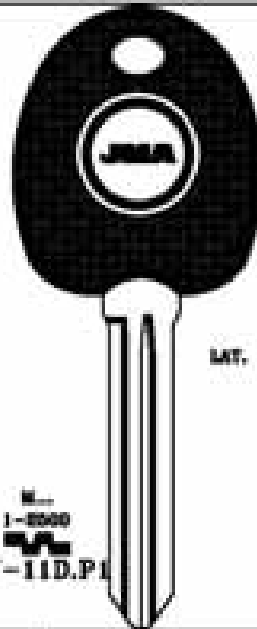

H...
1-2000

HY-11D.P1
LAT.

PARA:
FOR:

HYUNDAI

IMSA

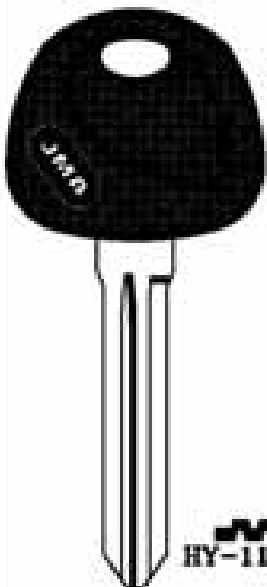

H...
1-2000

HY-11.P3

H...
1-2000

HY-11D.P3

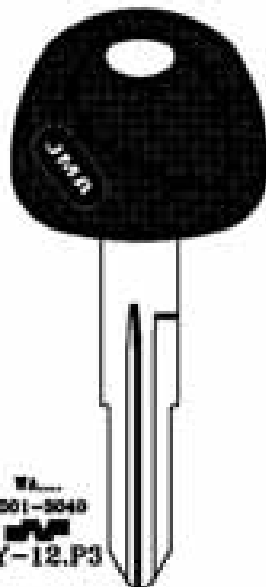

H...
1001-2040

HY-12.P3

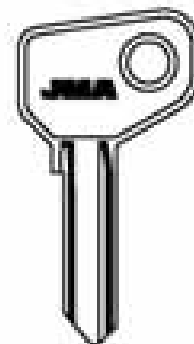

S
0001-1000

IMS-3C

I
0001-1000

IMS-5C

SAFE

PARA-FOR:

HYUNDAI (K)

IMSA (E)

Copyright by
Algebra Almas S.A.
2018

JMA



179

PARA-FOR:

IMSA (E)

ISUZU (J)

KAMAZ (RUS)

PARA-FOR: IMSA

IMS-6I IMS-6D
SAFE

2,3,4,5,6,7,8
IMS-7
LARGA BIFIDA-6647-6652E

2,3,4,5,6,7,8
IMS-7.P
LARGA BIFIDA-6647-6652E

3
0501-1000
IMS-8

1
0501-1000
IMS-9
SAFE

PARA-FOR: IMSA

IMS-10

IMS-11.P
BIFIDA

1
0501-1000
IMS-12
SAFE

L
051-300
IMS-MER
SAFE

PARA-FOR: ISUZU

A....
0501-0400
ISU-1
BIFIDA

A....
0501-0400
ISU-2
BIFIDA

ISU-3D.P

KAMAZ

KAM-1 KAM-1D
BIFIDA

Copyright by
Alpentrans Altrans S.A.
2019

JMA



180

PARA:
FOR:

KAWASAKI

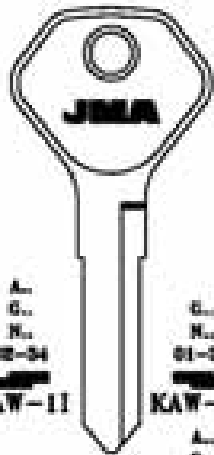

A.
G.
H.
02-04
KAW-11

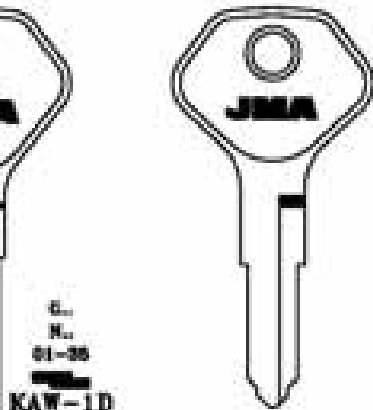

G.
H.
01-05
KAW-1D

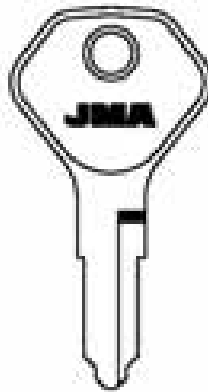

781-798
PLC
401-500
KAW-4
HYUNDAI-KAWASAKI

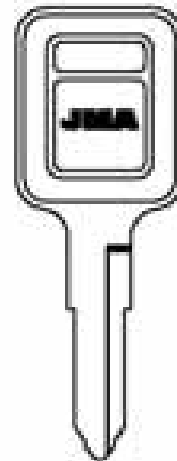

Z...
5000-6000
KAW-5
KAWASAKI

B...
1 AL 4
KAW-21
KAWASAKI

A.
G.
H.
1 AL 4
KAW-2D
KAWASAKI

I
5000-6000
KAW-3
KAWASAKI

PARA:
FOR:

KAWASAKI

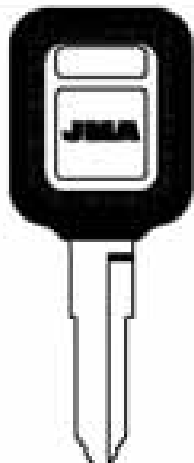

Z...
5000-6000
KAW-5.P
KAWASAKI

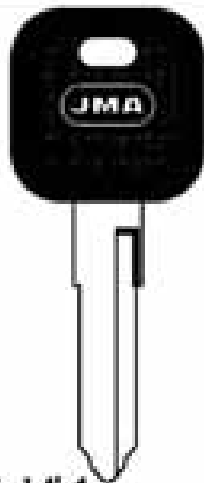

B... 1 AL 4
H... 1 AL 4
KAW-6.P KAW-8D.P
CAGIVA-SCOTT-KAWASAKI

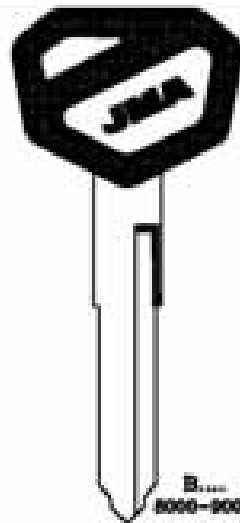

B...
5000-6000
KAW-7.P
KAWASAKI

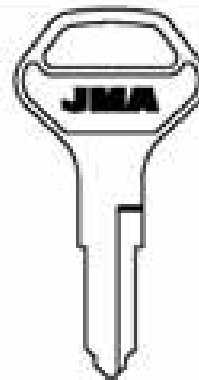

KAW-8 KAW-8D

PARA:
FOR: **KAWASAKI**

KENWORTH

KIA

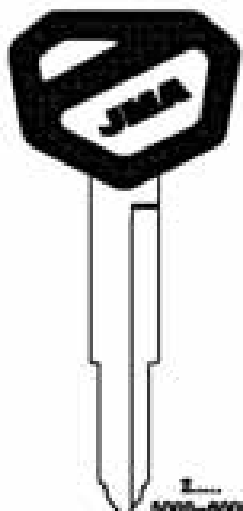

Z...
5000-6000
KAW-9.P
KAWASAKI

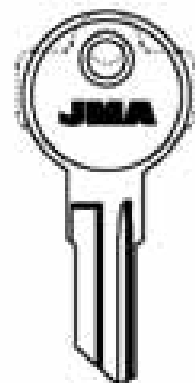

C...
250-400
1701-1900
KEN-1 KEN-1D
NASC

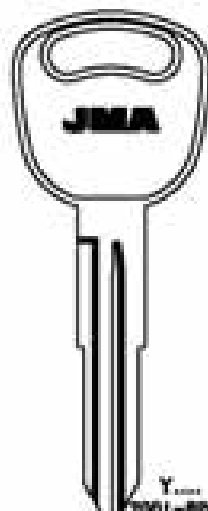

Y...
7001-8000
KI-1D
FORD (AUTOMOBILIO)-KIA

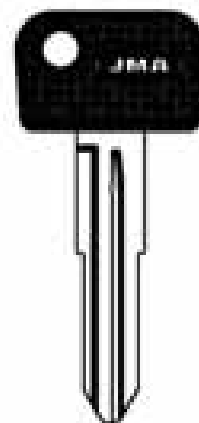

Y...
7001-8000
KI-1D.P

PARA-FOR:

KAWASAKI (J)

**KENWORTH
(USA)**

KIA (K)

Copyright by
Alejandro Altman S.A.
2018

JMA



181

PARA-FOR:

KIA (K)

KYMCO (K)

LADA BAKONY (RUS)

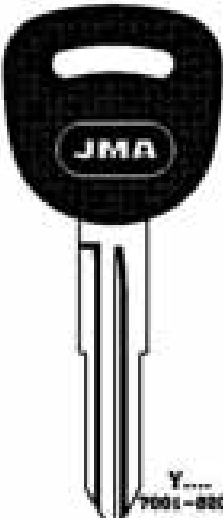
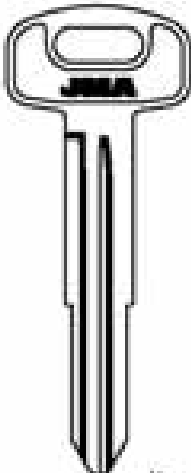
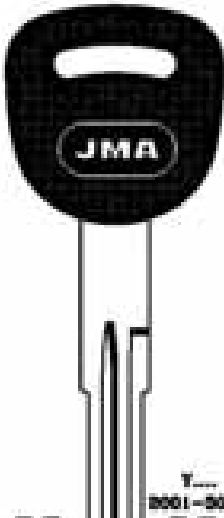
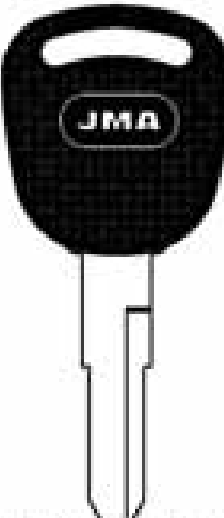
<p>PARA-FOR:</p> <p>KIA</p>  <p>Y... 7001-8000</p> <p>KI-1D.P1</p> <p>PIRE (CENTRALIZ)-KIA</p>	<p>PARA-FOR:</p> <p>KIA</p>  <p>Y... 7001-8000</p> <p>KI-2D</p> <p>PIRE (CENTRALIZ)-KIA</p>	<p>PARA-FOR:</p> <p>KIA</p>  <p>Y... 8001-9000</p> <p>KI-3.P</p> <p>KI-3D.P</p>	<p>PARA-FOR:</p> <p>KYMCO</p>  <p>KYM-1.P</p> <p>KYM-1D.P</p>
---	--	--	---

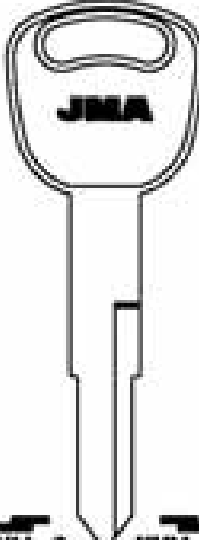
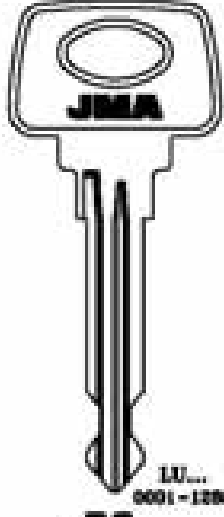
<p>PARA-FOR:</p> <p>KYMCO</p>  <p>KYM-2</p> <p>KYM-2D</p> <p>KYM-2.P</p> <p>KYM-2D.P</p>	<p>PARA-FOR:</p> <p>LADA BAKONY</p>  <p>LU... 0001-1000</p> <p>LA-1D</p> <p>LADA</p>
---	---

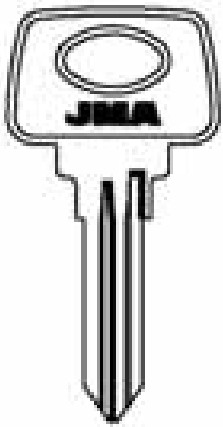
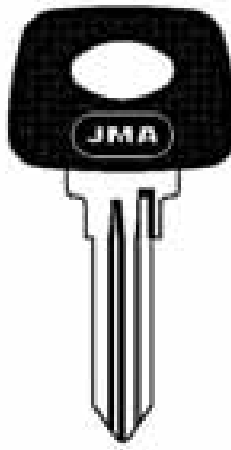
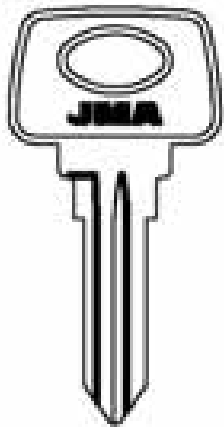
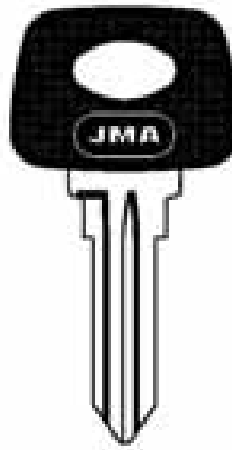
<p>PARA-FOR:</p> <p>LADA BAKONY</p>  <p>TU... 0001-1000</p> <p>LA-2</p> <p>LADA</p>	<p>PARA-FOR:</p> <p>LADA BAKONY</p>  <p>TU... 0001-1000</p> <p>LA-2.P</p> <p>LADA</p>	<p>PARA-FOR:</p> <p>LADA BAKONY</p>  <p>0 AL 3</p> <p>LA-3D</p> <p>LADA-MOROSYTCR</p>	<p>PARA-FOR:</p> <p>LADA BAKONY</p>  <p>0 AL 3</p> <p>LA-3D.P</p> <p>LADA-MOROSYTCR</p>
--	--	---	--

Copyright by
Alejandro Allina S.A.
2018

JMA



182

PARA:
FOR:

LADA BAKONY

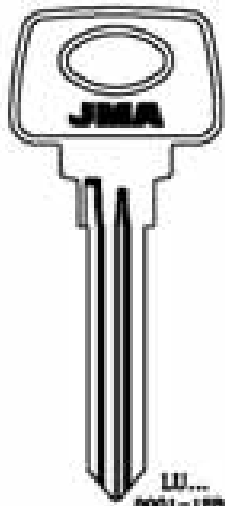

LU...
0001-1500
LAS-4D
LADA



LU...
0001-1500
LAS-4D.P
LADA

LAS

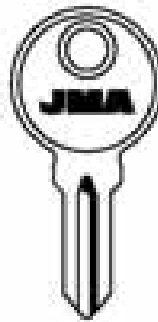

AX
001-224
LAS-AX
EX
LAS-1D

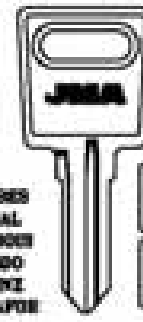

ADDIS
ATAL
BURDORF
GROD
KENEZ
STRAPOR

FH
LAS-2
FH
001-400
001-500
LAS-4

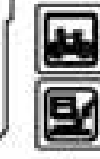

FH
001-400
001-500
LAS-FH
LAS-4D

ATAL-MARFELE-KIFERM-KENEZ

PARA:
FOR:

LAS



FH
001-400
001-500
LAS-3
H
LAS-5
U
LAS-U



E
LAS-5D
I
LAS-X

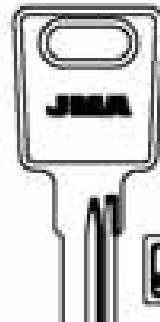

TA
LAS-6
AT
LAS-6D
EM
0001-2000
KT
LAS-KT
TK
4001-5000
LAS-TK

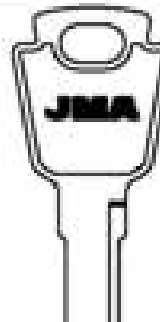

BT
001-550
LAS-BT
CR
001-550
LAS-CR
TB
001-550
LAS-TB
RC
001-550
LAS-RC

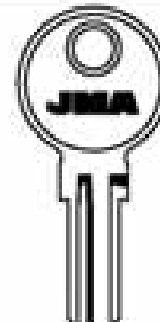

P
001-224
LAS-P

KIFERM

ATAL-KIFERM-MARCADET-BONDZ

KIFERM-PJ

PARA:
FOR:

LAS

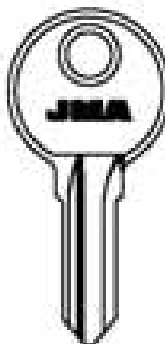

R
001-224
LAS-R
Y
001-224
LAS-Y

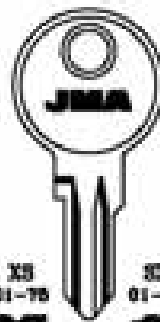

XS
01-75
LAS-XS
SX
01-75
LAS-SX
TX
01-75
LAS-TX
XY
01-75
LAS-XY

LMP

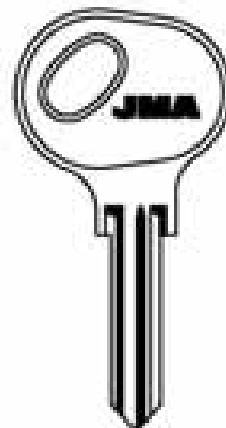

10000-12500
LMP-1
BENO-PECCOY-SENAULT
GELDON-ROB-SEINA

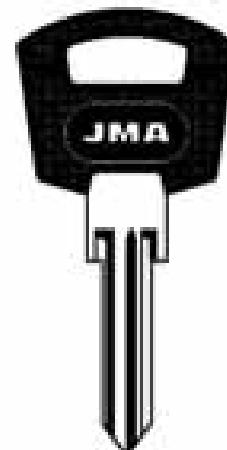

10000-12500
LMP-1.P
BENO-PECCOY-SENAULT
GELDON-ROB-SEINA

PARA-FOR:

LADA BAKONY
(RUS)

LAS (F)

LMP (F)

Copyright by
Alpine Alpin S.A.
2010

JMA

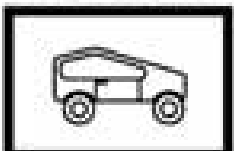

183

PARA-FOR:

LMP (F)

L. & F. (GB)

PARA-FOR:

LMP

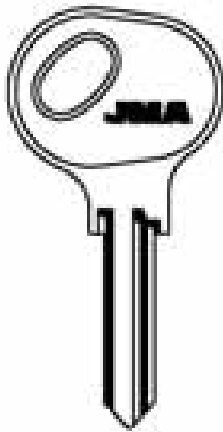

80000-85827
80001-82000
LMP-2
PEUGEOT-RENAULT
CITROEN-SEIMA



80000-85827
80001-82000
LMP-2.P
PEUGEOT-RENAULT
CITROEN-SEIMA

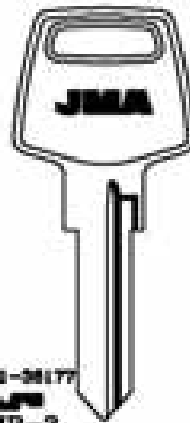

30001-38177
LMP-3

70001-72000
75000-77500
1AA-772

LMP-4

PEUGEOT-RENAULT-TALBOT
CITROEN-SEIMA

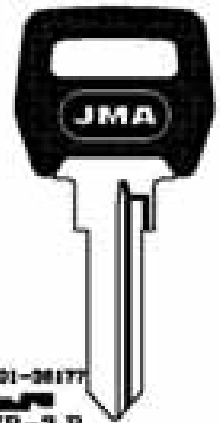

30001-38177
LMP-3.P

70001-72000
75000-77500
1AA-772

LMP-4.P

PEUGEOT-RENAULT-TALBOT
CITROEN-SEIMA

LMP-5.P

PARA-FOR:

LMP

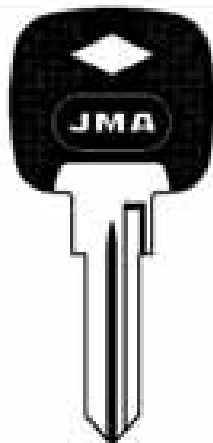

70001-72000
75000-77500
1AA-772

LMP-4.P1
RENAULT
CITROEN-SEIMA

LOWE AND FLETCHER



90...1-200
...1-400
91...201-270
92...1-4000
93...1-400
91...270-350

LF-11
CEM-EURO LOCKS-UNION

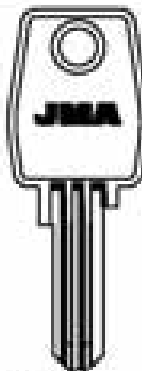

95001-97000
97001-99000

LF-2

LF-12
MIDDLETON CYCLES
DOUBLE SAFE-EURO LOCKS

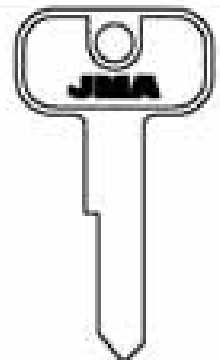

91-9M
901-952

LF-3
STRONG

PARA-FOR:

LOWE AND FLETCHER

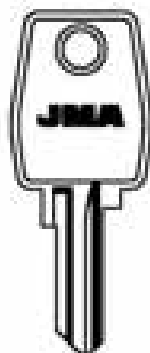

LF-41

EURO LOCKS

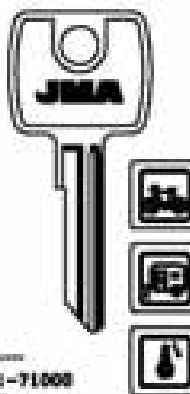

70001-71000
70001-71000

LF-5 **LF-50**

LF-32

TILFORD

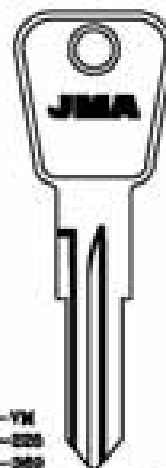

FY-YH
101-220
301-350
YT...
400-474

LF-6

CRYSTAL-YACHTS-REDFORD-PURE

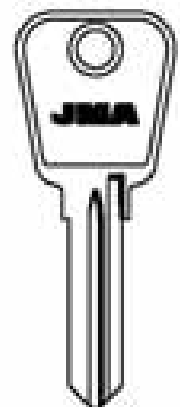

85001-87000 81501-87000

LF-7 **LF-70**

PURE EUROPS

Copyright by
Alfredo Altini S.A.
1978

JMA



PARA:
FOR:

LOWE & FLETCHER

PARA-FOR:

L. & F. (GB)

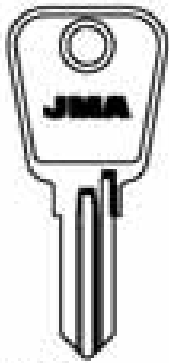

93...001-400
...93001-94000



93...401-800
...90001-90075



EURO LOCKS-MIRRA-LITE

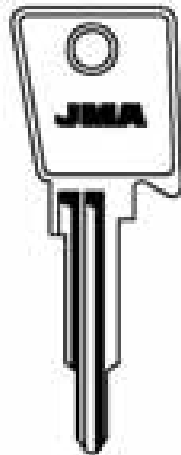

15001-19000
55001-57000



KEYS-KEYS
BETA

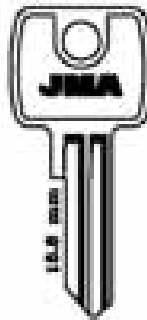

93... 001-200
93... 001-200
93... 001-200
...1-400
CEM...1-100
M...1-400
BY...1-400
BYW...1-400
SP...1-400
93...1-400



FPE
001-100



CEM-EURO LOCKS-ULTRA-UNION

PARA:
FOR:

LOWE & FLETCHER



EURO LOCKS

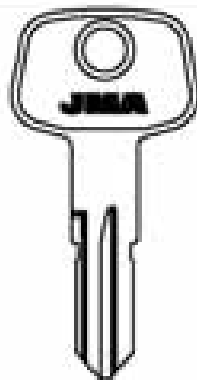

LF-39D

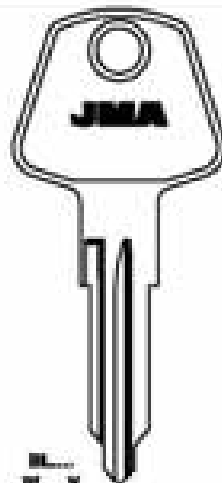

93...
93...N
1001-2000



LF-BL

BETA

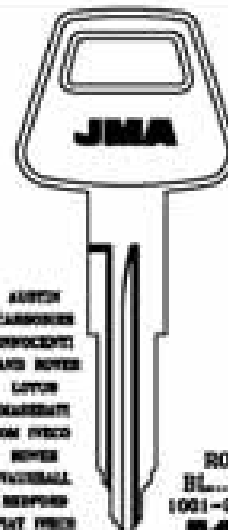

AUTON
CARROZZE
INNOCENTI
LAMB VESPA
LUTON
MARELLI
ON FICO
ROVER
TATUNG
VEPORA
PIAT FICO

RO
93...N
1001-2000



LF-RO

PARA:
FOR:

LOWE & FLETCHER

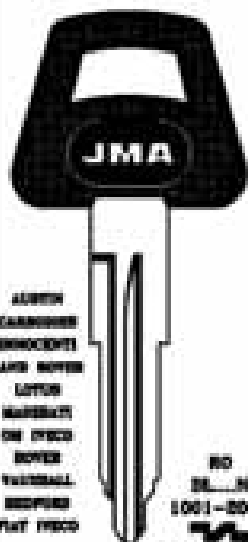

AUTON
CARROZZE
INNOCENTI
LAMB VESPA
LUTON
MARELLI
ON FICO
ROVER
TATUNG
VEPORA
PIAT FICO

RO
93...N
1001-2000
LF-RO.P

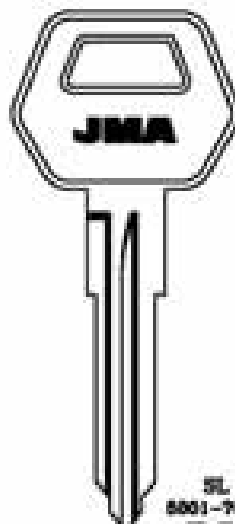

SL
5001-7000
LF-SL

CONTINENTAL-PIRELLI (USA)-BENTON
ROOFS

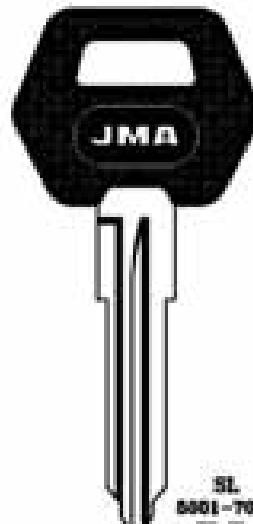

SL
5001-7000
LF-SL.P

CONTINENTAL-PIRELLI (USA)-BENTON
ROOFS

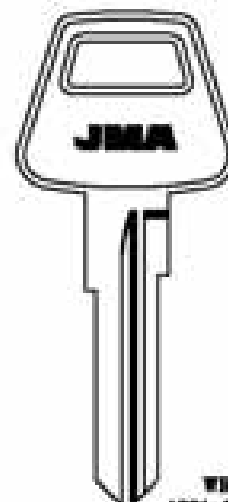

WB
1001-2000
LF-WB

TRUMPS
WILMOT BENTON

Copyright by
Algebra Alfa S.A.
2010

JMA



185

PARA:
FOR:

MAZDA

PARA-FOR:

MAZDA (J)

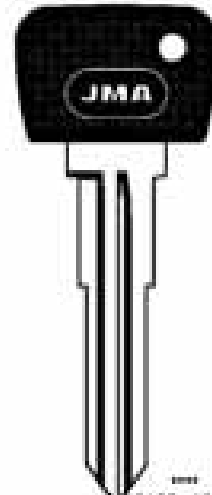
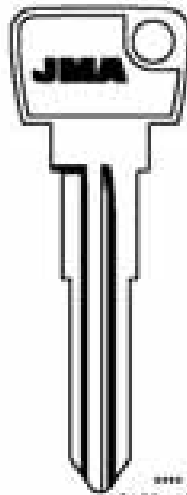
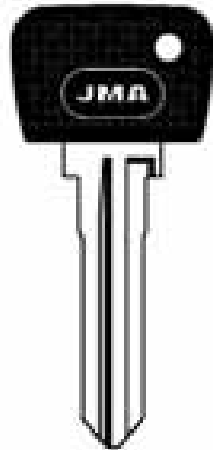
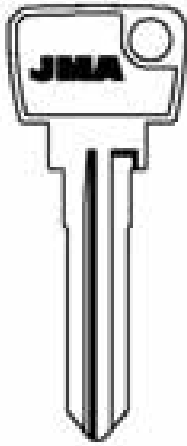

8000-7732
MAZ-6 MAZ-6D
FORM (JMA)-MAZDA

8000-7732
MAZ-6.P MAZ-6D.P
FORM (JMA)-MAZDA

10100-12000
MAZ-7D
MAZDA

10100-12000
MAZ-7D.P
MAZDA

PARA:
FOR:

MAZDA

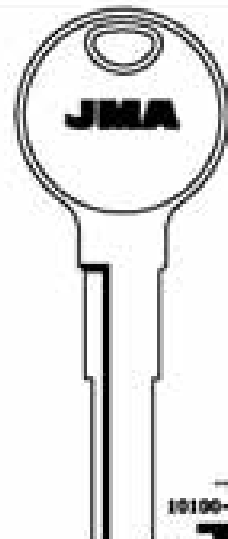
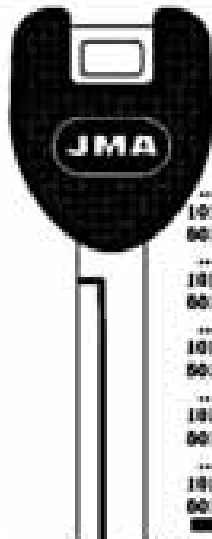
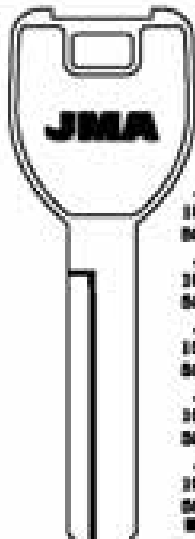
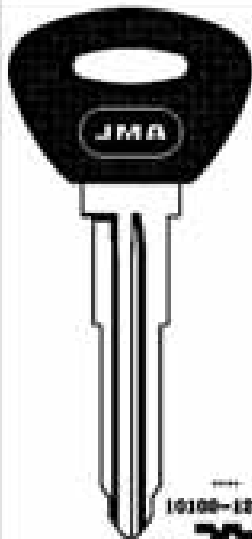

10100-12000
MAZ-7D.P1
MAZDA

...A...
101-891
501-879
...B...
101-832
501-808
...C...
101-844
501-834
...D...
101-827
501-808
...E...
101-898
501-879
MAZ-8D
MAZDA

...A...
101-891
501-879
...B...
101-832
501-808
...C...
101-844
501-834
...D...
101-827
501-808
...E...
101-898
501-879
MAZ-8D.P
MAZDA

10100-12000
MAZ-11D
MAZDA

PARA:
FOR:

MAZDA

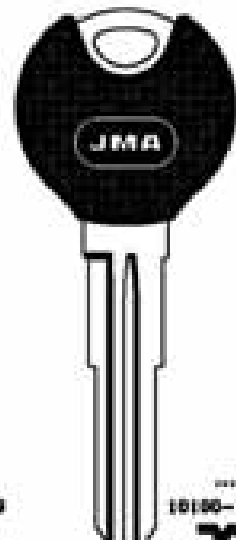
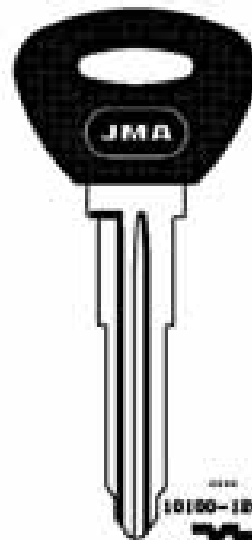
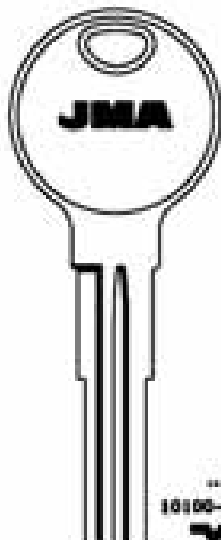
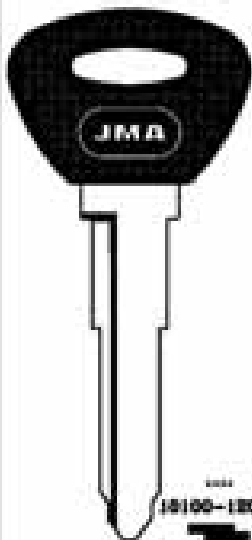

10100-12000
MAZ-11D.P1
MAZDA

10100-12000
MAZ-13D
MAZDA

10100-12000
MAZ-13D.P
MAZDA

10100-12000
MAZ-13D.P1
MAZDA

Copyright by
Algebra Almas S.A.
2018

JMA



187

PARA-FOR:

MAZDA (J)

MERIT-LINDE (D)

MITSUBISHI (J)

PARA-FOR: MAZDA



...000-000
MAZ-14D

MAZ-15D

1-3500
MAZ-16

10100-10000
MAZ-21D.P

PARA-FOR: MERIT-LINDE

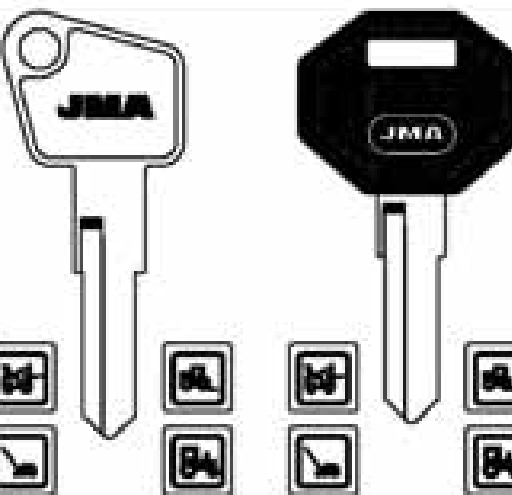

MERI-1D

MERI-1D.P

PARA-FOR: MITSUBISHI

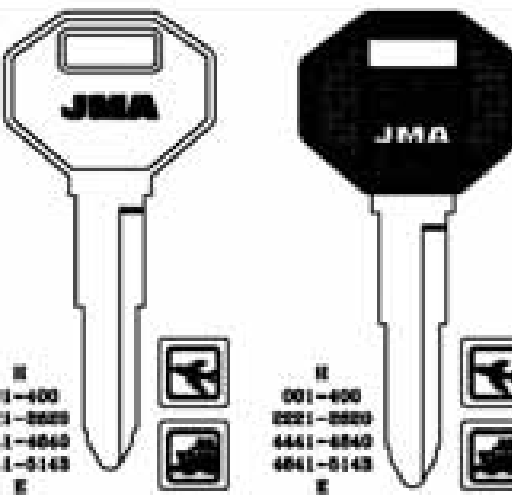

001-400
0001-0000
4441-0040
4841-0140
E
0001-0000

MIT-11

001-400
0001-0000
4441-0040
4841-0140
E
0001-0000

MIT-1D

MIT-11.P

MIT-1D.P

PARA-FOR: MITSUBISHI

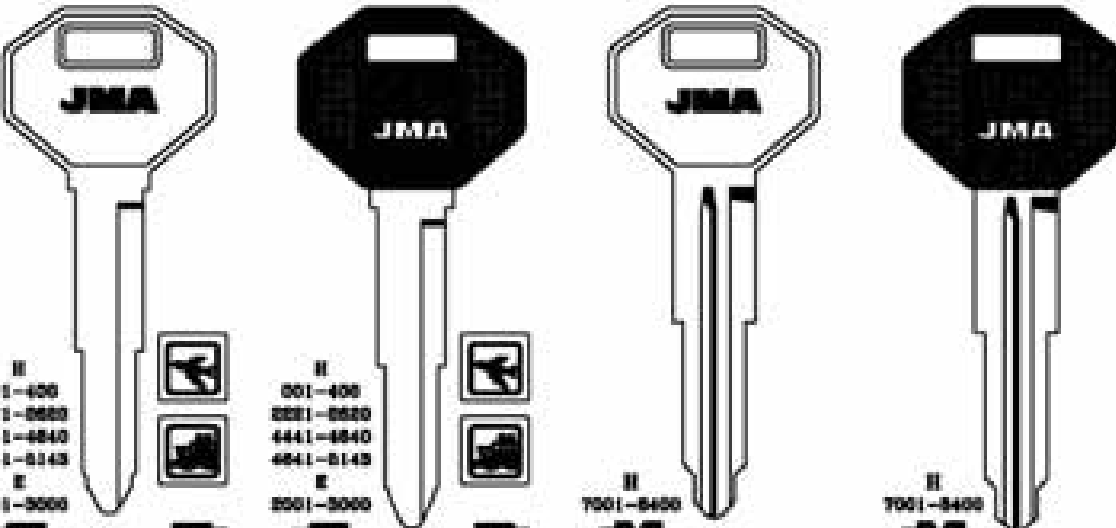

001-400
0001-0000
4441-0040
4841-0140
E
0001-0000

MIT-21

001-400
0001-0000
4441-0040
4841-0140
E
0001-0000

MIT-2D

MIT-21.P

MIT-2D.P

7001-0400
MIT-3

7001-0400
MIT-3.P

Copyright by
Algodoro Altam S.A.
1978

JMA



188

PARA:
FOR:

MITSUBISHI

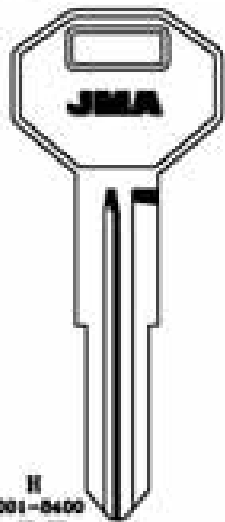

H
7001-8400
MIT-4
MITSUBISHI

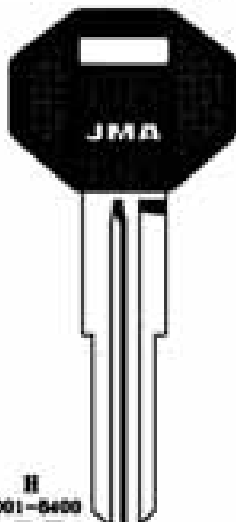

H
7001-8400
MIT-4.P
MITSUBISHI

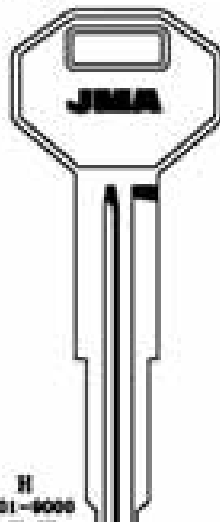

H
7001-8000
MIT-5
MITSUBISHI

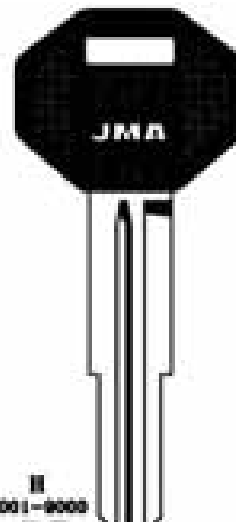

H
7001-8000
MIT-5.P
MITSUBISHI

PARA-FOR:

MITSUBISHI
(J)

PARA:
FOR:

MITSUBISHI

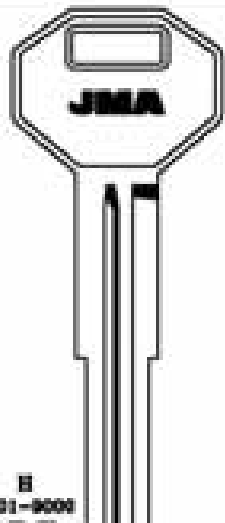

H
7001-9000
MIT-6
MITSUBISHI

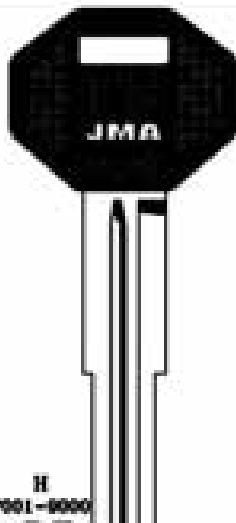

H
7001-9000
MIT-6.P
MITSUBISHI

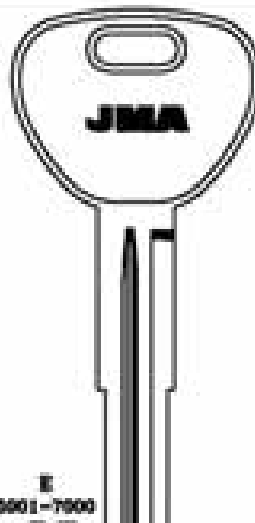

E
5001-7000
MIT-7
MITSUBISHI

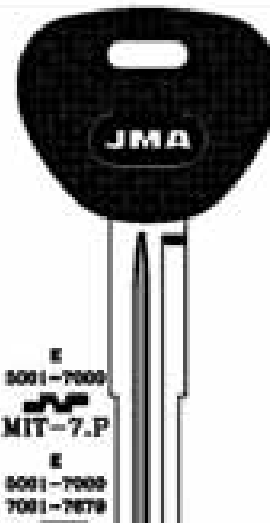

E
5001-7000
MIT-7.P
MITSUBISHI
E
5001-7000
7001-7879
MIT-15.P
MITSUBISHI

PARA:
FOR:

MITSUBISHI

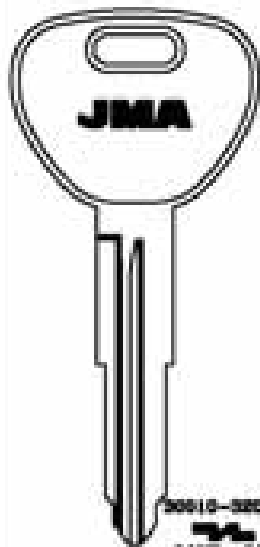

50010-32000
MIT-8D
MITSUBISHI

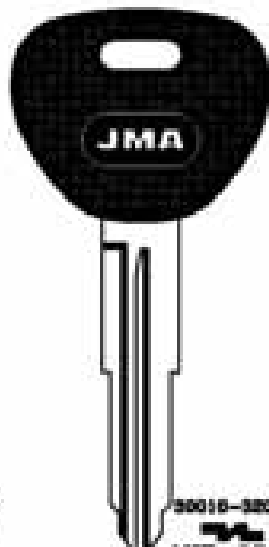

50010-32000
MIT-8D.P
MITSUBISHI

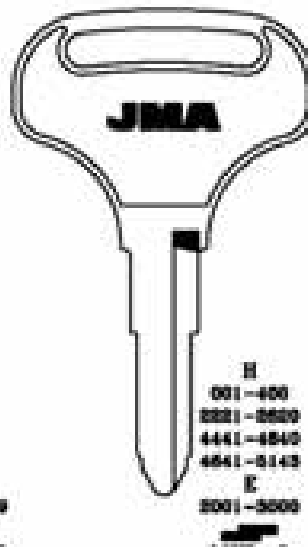

H
001-400
2221-2220
4441-4440
4441-5143
E
5001-5000
MIT-9
MITSUBISHI

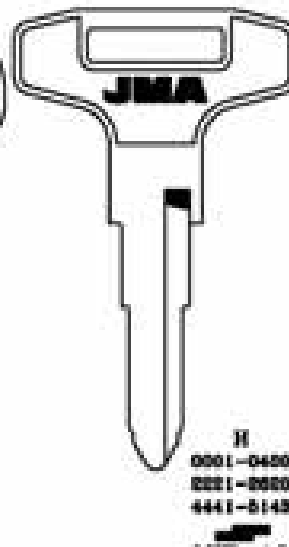

H
0001-0400
2221-2220
4441-5143
MIT-10
MITSUBISHI

Copyright by
Algebra Almas S.A.
2018

JMA







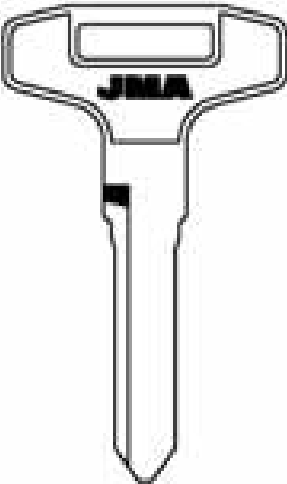
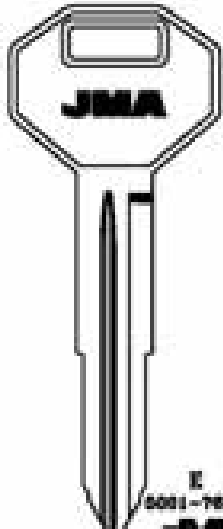
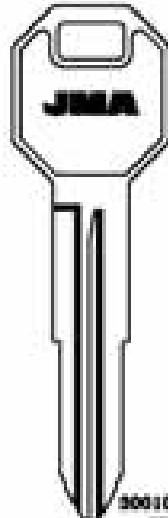
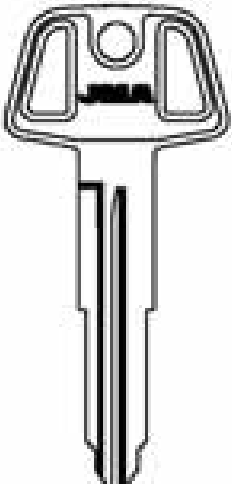

189

PARA-FOR:

- MITSUBISHI (J)**
- MOSKVITCH (RUS)**
- NEIMAN (F)**

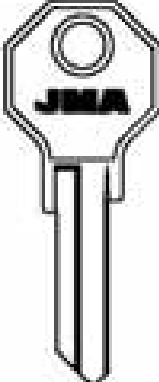
PARA-FOR: MITSUBISHI

 <p style="text-align: center;">8100-8110 MIT-11D MITSUBISHI</p>	 <p style="text-align: center;">E 5001-7879 MIT-12 MITSUBISHI-CHRYSLER-MITSUBISHI</p>	 <p style="text-align: center;">30010-30000 MIT-13D</p>	 <p style="text-align: center;">30010-30000 MIT-14D CHRYSLER-MITSUBISHI</p>
--	---	--	---

<p>PARA-FOR: MOSKVITCH</p>  <p style="text-align: center;">MOS-1</p>	<p>NEIMAN</p>  <p style="text-align: center;">41-4/4 NEIMAN</p>  <p style="text-align: center;">...3001-1940 CM ...3001-3000 NE-1</p>  <p style="text-align: center;">...3001-1940 CM ...3001-3000 NE-1D</p> <p style="text-align: center;">CLAUSOR</p>  <p style="text-align: center;">...3001-1940 CM ...3001-3000 NE-1.P</p>  <p style="text-align: center;">...3001-1940 CM ...3001-3000 NE-1D.P</p> <p style="text-align: center;">CLAUSOR</p>
--	---

PARA-FOR: NEIMAN

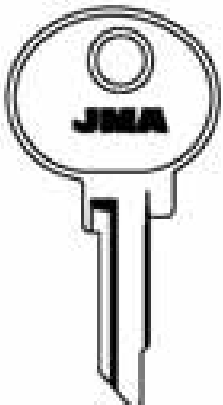
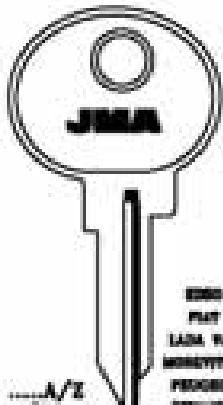
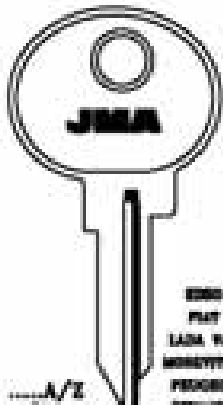
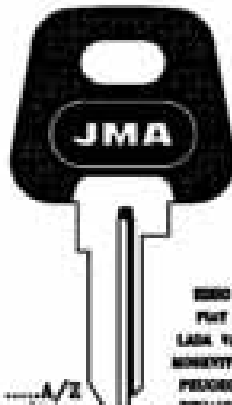
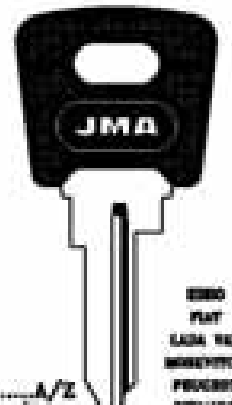
 <p style="text-align: center;">S,T,X,Y Z,R 1-5-5-5-7 NE-2</p> <p style="text-align: center;">CLAUSOR</p>	 <p style="text-align: center;">...A/Z A/Z... A/Z...A/Z 1 AL 7 ...A/Z 0 AL 9 NE-3</p> <p style="text-align: center;">CLAUSOR</p>	 <p style="text-align: center;">E200 FAT LAMA P&E MOSKVITCH PEUGEOT RENAULT TALANT BRICA S&P S&P VOLVO NE-3D</p> <p style="text-align: center;">CLAUSOR</p>	 <p style="text-align: center;">...A/Z A/Z... A/Z...A/Z 1 AL 7 ...A/Z 0 AL 9 NE-3.P</p> <p style="text-align: center;">CLAUSOR</p>	 <p style="text-align: center;">...A/Z A/Z... A/Z...A/Z 1 AL 7 ...A/Z 0 AL 9 NE-3.P1</p> <p style="text-align: center;">CLAUSOR</p>
---	--	---	---	---

Copyright by
Alejandro Altamir S.A.
2018

JMA



190

PARA:
FOR:

NEIMAN



.....A/Z
A/Z.....
A/Z.....A/Z
1 AL 7
.....A/Z
0 AL 8

SEMP
PLAT
LAKA V&E
MOTOR/TECA
PERCOT
SERAGUT
TALANG BIRUK
S&S
S&P
V&P&S

NE-3.P2

CLAUSOR

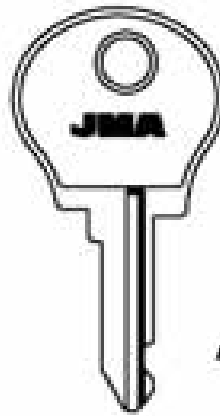

A/Z.....
A/Z.....A/Z
A/Z.....A/Z
0 AL 8
1 AL 7
A/Z.....1 AL 7 Y A AL 8

NE-4 **NE-4D**

11-04-08...
1 AL 7
04-08...A/Z
1 AL 7

NE-15I **NE-15D**

ACB-480 BACA-CITRUS-PLAT-SERAGUT
CLAUSOR

PARA-FOR:

NEIMAN (F)

PARA:
FOR:

NEIMAN

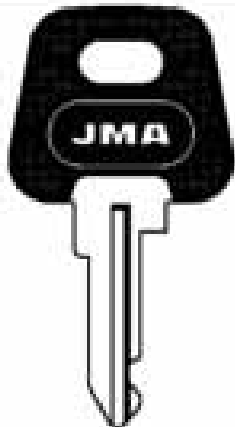

A/Z.....
A/Z.....A/Z
A/Z.....A/Z
0 AL 8
1 AL 7
A/Z.....1 AL 7 Y A AL 8

NE-4.P

11-04-08...
1 AL 7
04-08...A/Z
1 AL 7

NE-15I.P **NE-15D.P**

ACB-480 BACA-CITRUS-PLAT-SERAGUT
CLAUSOR

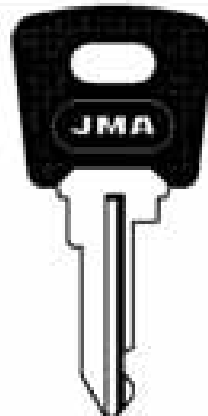

A/Z.....
A/Z.....A/Z
A/Z.....A/Z
0 AL 8
1 AL 7
A/Z.....1 AL 7 Y A AL 8

NE-4.P1

11-04-08...
1 AL 7
04-08...A/Z
1 AL 7

NE-15I.P1 **NE-15D.P1**

ACB-480 BACA-CITRUS-PLAT-SERAGUT
CLAUSOR

PARA:
FOR:

NEIMAN

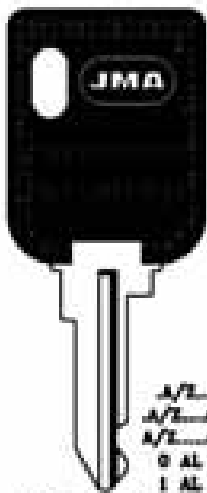

A/Z.....
A/Z.....A/Z
A/Z.....A/Z
0 AL 8
1 AL 7
A/Z.....1 AL 7 Y A AL 8

NE-4.P2

SERAGUT
CLAUSOR

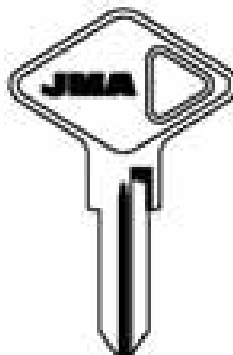

NE-5
CLAUSOR

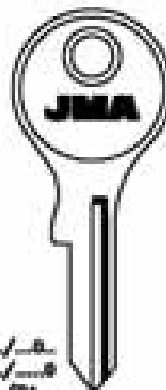

...../.....
...../.....
A...../B.....
C...../D.....
...../.....
...../.....
...../.....
1 AL 8

NE-6

TALANG BIRUK DE MOTOR



...../.....
...../.....
A...../B.....
C...../D.....
...../.....
...../.....
...../.....
1 AL 8

NE-6.P

TALANG BIRUK DE MOTOR

Copyright by
Algebra Almas S.A.
2018

JMA



191

PARA-FOR:

NEIMAN (F)

NEIMAN

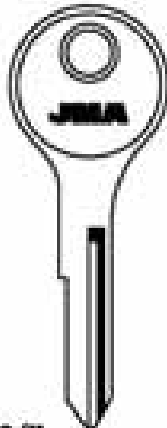

...0/H...
H.../...H...
...H./...H...
I AL 5
NE-7
MOT



A.../B...
...0/B...0
AA.../BA...
CA...
I AL 5
NE-8
TAMAS BARGAS DE MOTOR
CLAUSOR

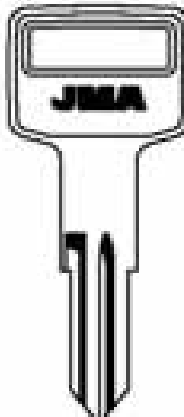

...8250-8499
NE-9
MOT
CLAUSOR

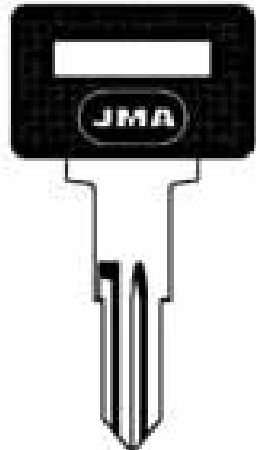

...8250-8499
NE-9.P
MOT
CLAUSOR

NEIMAN

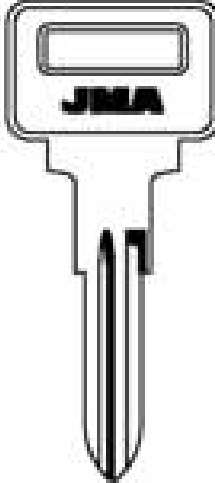

...7001-9000
NE-10
DE LUBRIF-SC-TOLFO-BEOPRE

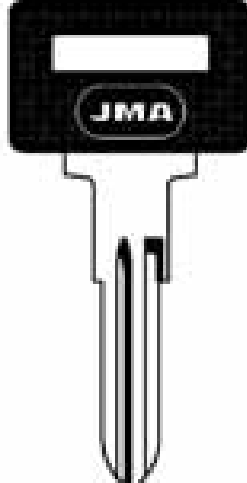

...7001-9000
NE-10.P
DE LUBRIF-SC-TOLFO-BEOPRE

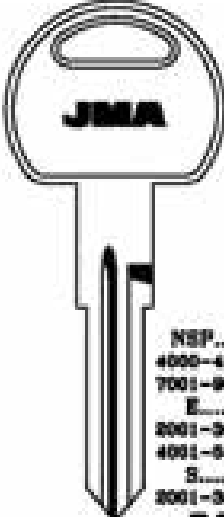

NSP...
4000-4999
7001-9000
E...
2001-3000
4001-5000
S...
2001-3000
NE-11
FIMO-NEBIA-BYTER-STERLING
SAP-EDWATE

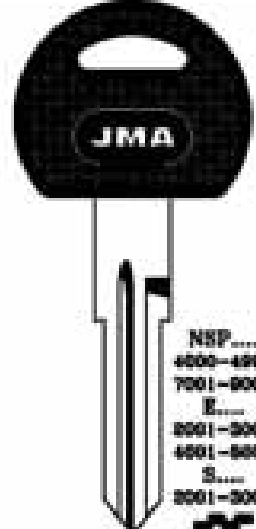

NSP...
4000-4999
7001-9000
E...
2001-3000
4001-5000
S...
2001-3000
NE-11.P
FIMO-NEBIA-BYTER-STERLING
SAP-EDWATE

NEIMAN



NSP...
4000-4999
7001-9000
E...
2001-3000
4001-5000
S...
2001-3000
NE-11.P1
LARE BARGE BOYER-BOYER

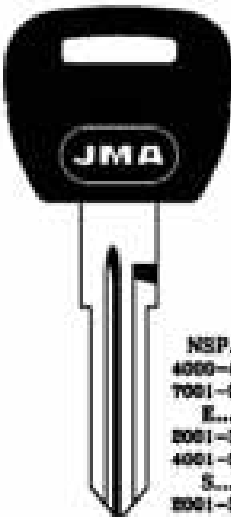

NSP...
4000-4999
7001-9000
E...
2001-3000
4001-5000
S...
2001-3000
NE-11.P2
BOYER

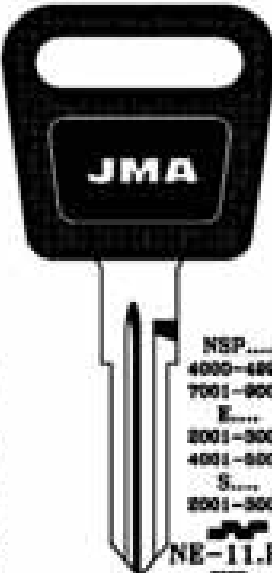

NSP...
4000-4999
7001-9000
E...
2001-3000
4001-5000
S...
2001-3000
NE-11.P3
FIMO

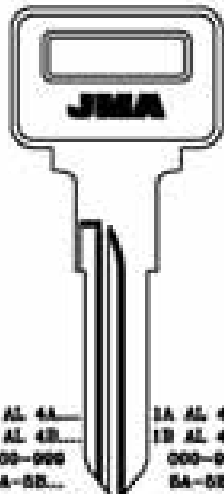

IA AL 4A...
IB AL 4B...
000-099
5A-5E...
000-744
NE-12
TOLFO

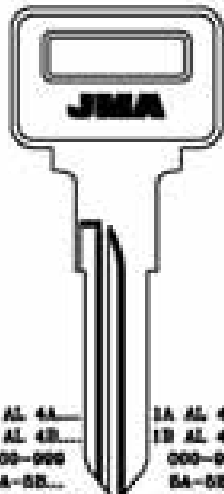

IA AL 4A...
IB AL 4B...
000-099
5A-5E...
000-744
NE-13
TOLFO

Copyright by
Alejandro Altuna S.A.
2018



ATTENZIONE: Copiare e/o stampare e distribuire informazioni commerciali per i dati in bianco. ATTENZIONE: Copiare e/o stampare e distribuire informazioni per i dati in nero. ATTENZIONE: Copiare e/o stampare e distribuire informazioni commerciali per i dati in bianco e/o in nero. ATTENZIONE: Copiare e/o stampare e distribuire informazioni per i dati in bianco e/o in nero.

PARA:
FOR:

NEIMAN

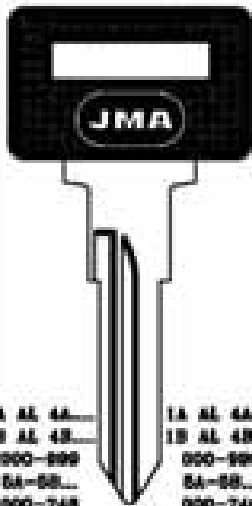

1A AL 4A...
1B AL 4B...
000-999
5A-5B...
000-748
NE-12.P
VOLVO

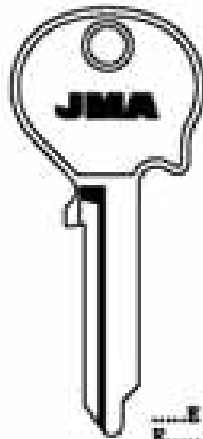

.....E
E....
N....
X....
1 AL 5
NE-13
VOLVO

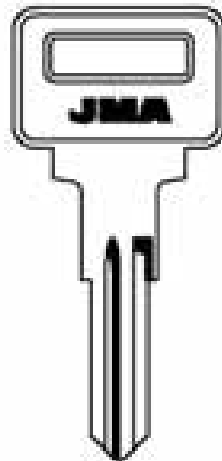

NP...
1-1000
NE-14
BMW
BMW
BMW

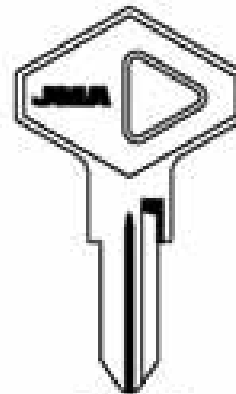

T...001-999
Y...000-999
Z....
E...A/Z
B-C-D-E-G
NE-16
AMERICAN MOTORS-CHRYSLER
CLAUSSER

PARA-FOR:

NEIMAN (F)

PARA:
FOR:

NEIMAN

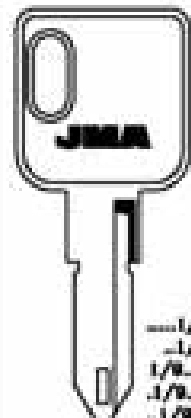

...1/2A/Z
1/2...
1/2...A/Z
1/2...A/Z
...1/2...A/Z
...1/2...A/Z
...1/2...A/Z
...1/2...A/Z 1/2
M-N-P-R-S
NE-19
AMERICAN MOTORS-CHRYSLER-PEUGEOT
RENAULT

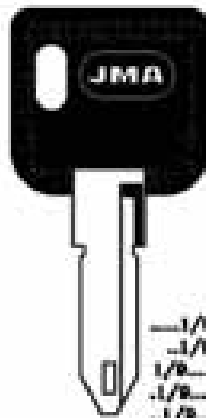

...1/2A/Z
1/2...
1/2...A/Z
1/2...A/Z
...1/2...A/Z
...1/2...A/Z
...1/2...A/Z
...1/2...A/Z 1/2
M-N-P-R-S
NE-19.P
AMERICAN MOTORS-CHRYSLER-PEUGEOT
RENAULT



...1/2A/Z
1/2...
1/2...A/Z
1/2...A/Z
...1/2...A/Z
...1/2...A/Z
...1/2...A/Z
...1/2...A/Z 1/2
M-N-P-R-S
NE-19.P1
RENAULT

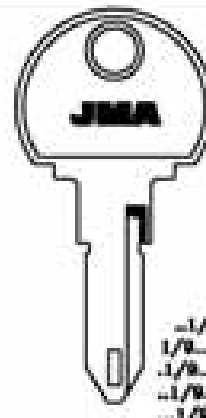

...1/2...
1/2...A/Z
1/2...A/Z
...1/2...A/Z
...1/2...A/Z
...1/2...A/Z
...1/2...A/Z 1/2
M-N-P-R-S
NE-20
PEUGEOT

PARA:
FOR:

NEIMAN

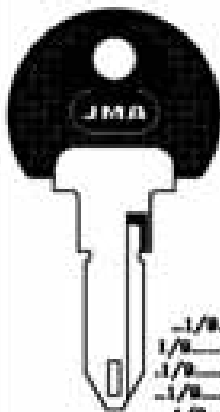

...1/2...
1/2...A/Z
1/2...A/Z
...1/2...A/Z
...1/2...A/Z
...1/2...A/Z
...1/2...A/Z 1/2
M-N-P-R-S
NE-20.P
PEUGEOT

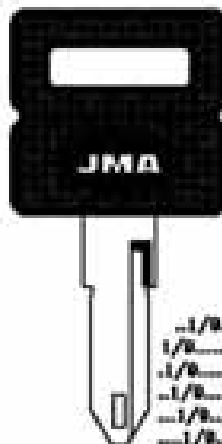

...1/2...
1/2...A/Z
1/2...A/Z
...1/2...A/Z
...1/2...A/Z
...1/2...A/Z
...1/2...A/Z 1/2
M-N-P-R-S
NE-20.P1
PEUGEOT



...1/2...
1/2...A/Z
1/2...A/Z
...1/2...A/Z
...1/2...A/Z
...1/2...A/Z
...1/2...A/Z 1/2
M-N-P-R-S
NE-20.P2
PEUGEOT

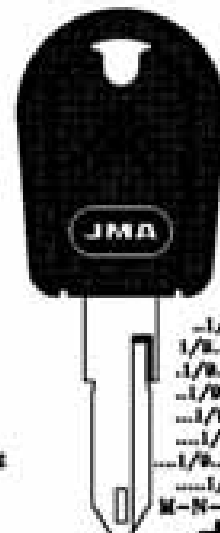

...1/2...
1/2...A/Z
1/2...A/Z
...1/2...A/Z
...1/2...A/Z
...1/2...A/Z
...1/2...A/Z 1/2
M-N-P-R-S
NE-20.P3
CITROEN

Copyright by
Alejandro Almon S.A.
2010



ATTENCIÓN: Reservados todos los derechos y dimensiones comerciales con nota de folio. ATTENÇÃO: Reservados todos os direitos e dimensões comerciais com nota de folio. ATTENTION: Copyright by Alejandro Almon S.A. 2010. All rights reserved. All dimensions and commercial notes are on file.

PARA-FOR:

NEIMAN (F)

PARA-FOR: NEIMAN

NE-21.P
 VOLVO
 FANTEK

.....A/Z
 B-C-D-E
 1/8.....A/Z
 1/8.....A/Z
A/Z
 B-D-E-G-H-J
 .1/8.....A/Z
 .1/8.....A/Z
 E-M-N-P-R
NE-22.P
 CLAUSS

.....A/Z
 B-C-D-E
 1/8.....A/Z
 1/8.....A/Z
A/Z
 B-D-E-G-H-J
 .1/8.....A/Z
 .1/8.....A/Z
 E-M-N-P-R
NE-22.P1
 CYLINDER-PROUDOT-PELAGO
 CLAUSS

.....A/Z
 B-C-D-E
 1/8.....A/Z
 1/8.....A/Z
A/Z
 B-D-E-G-H-J
 .1/8.....A/Z
 .1/8.....A/Z
 E-M-N-P-R
NE-22.P2
 BADA-TALENT BERCA-SAP
 CLAUSS

PARA-FOR: NEIMAN

NSP....
 4000-4999
 7001-9000
 E....
 8001-9000
 4001-6000
 S....
 2001-3000
NE-23
 BADA

NSP....
 4000-4999
 7001-9000
 E....
 8001-9000
 4001-6000
 S....
 2001-3000
NE-24
 FINE-SWISS-STERLING

NSP....
 4000-4999
 7001-9000
 E....
 8001-9000
 4001-6000
 S....
 2001-3000
NE-24.P
 FINE-SWISS-STERLING

NSP....
 4000-4999
 7001-9000
 E....
 8001-9000
 4001-6000
 S....
 2001-3000
NE-24.P1
 LANE RANGE SWISS-SWISS

PARA-FOR: NEIMAN

.....A
B
F
 1 AL 6
NE-25
 ALFA ROMEO-FERRARIS-PIRELLA PUCK

NE-27

.....1/8.....A/Z
 M-N-P-R-S
NE-28
 CHRYSLER (SABLE)-RENAULT

.....1/8.....
 1/8.....A/Z
 .1/8.....A/Z
 .1/8.....A/Z
1/8.....A/Z
1/8.....A/Z
1/8.....A/Z
 M-N-P-R-S
NE-29
 PEUGEOT

Copyright by
Allegretto Allina S.A.
2018

JMA





194

PARA:
FOR:

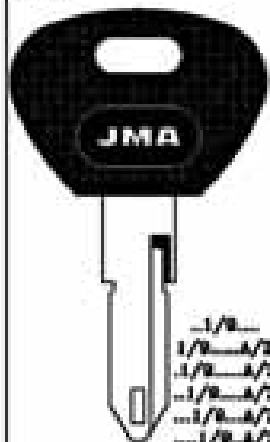

NEIMAN



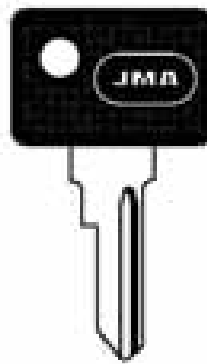

...1/8...
 1/8...A/2
 1/8...A/2
 ...1/8...A/2
 ...1/8...A/2
 ...1/8...A/2
 ...1/8...A/2 A/2
 ...1/8...A/2
 M-N-P-E-S
 NE-29.P
 PEUGEOT

...
 5001-5075
 NE-30
 BASTA

...
 5001-5075
 NE-30.P
 BASTA



...1/8...A/2
 M-N-P-E-S
 NE-31
 BASTA

PARA-FOR:

NEIMAN (F)

PARA:
FOR:

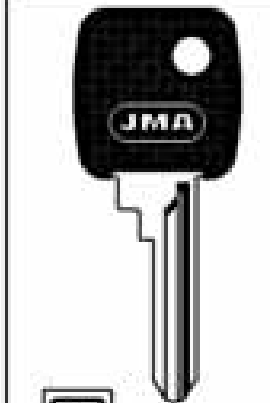
NEIMAN

...1/8...A/2
 M-N-P-E-S
 NE-31.P
 BASTA



...S-S-7-L
 ...S-S-7-L/S-S-7-L
 ...S-S-7-L
 ...S-S-7-L
 NE-32
 BASTA



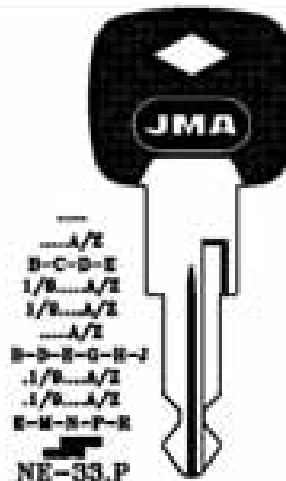

...S-S-7-L
 ...S-S-7-L/S-S-7-L
 ...S-S-7-L
 ...S-S-7-L
 NE-32.P
 BASTA



...A/2
 B-C-D-E
 1/8...A/2
 1/8...A/2
 ...A/2
 B-S-S-S-S-J
 1/8...A/2
 1/8...A/2
 E-M-N-P-E
 NE-44.P
 PEUGEOT
 CLAUDOR

PARA:
FOR:

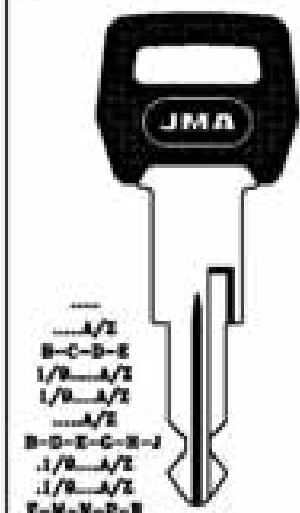
NEIMAN



...A/2
 B-C-D-E
 1/8...A/2
 1/8...A/2
 ...A/2
 B-D-E-C-E-J
 1/8...A/2
 1/8...A/2
 E-M-N-P-E
 NE-33.P1
 TALBOT
 BORG
 CLAUDOR



LAT.
 M/A/2...
 D AL B
 A AL F
 X
 PEUGEOT
 NE-34.P

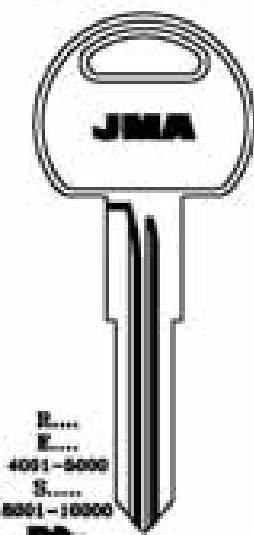

E...
 E...
 4001-5000
 S...
 5001-10000
 NE-35
 BORG
 BORG

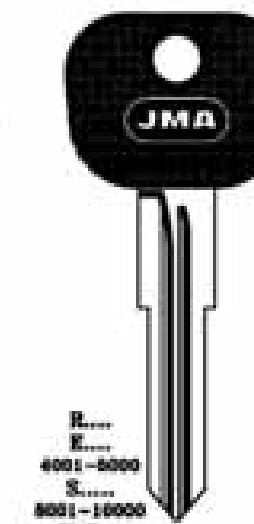

R...
 E...
 4001-5000
 S...
 5001-10000
 NE-35.P
 BORG

Copyright by
Magnum Alfas S.A.
2000

JMA





195

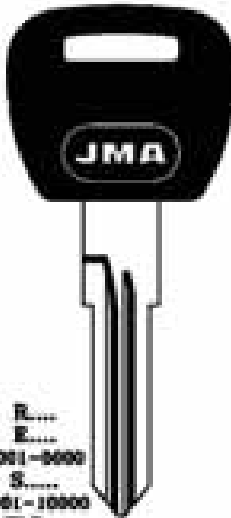
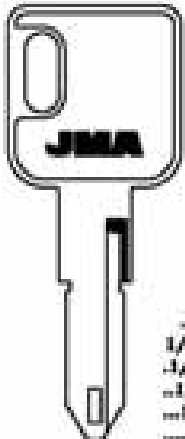
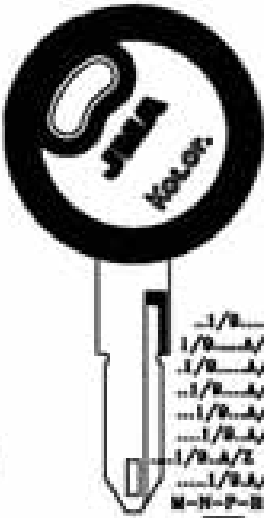

PARA-FOR:

NEIMAN (F)

NEIMAN

 <p>R... E... 4001-5000 S... 5001-10000</p> <p>NE-35.P2 REMOVAL-ROVER</p>	 <p>...1/8... 1/8...A/2 1/8...A/2 ...1/8...A/2 ...1/8...A/2 ...1/8...A/2 ...1/8...A/2 ...1/8...A/2 A/2 ...1/8...A/2 M-N-P-R-S</p> <p>NE-36 CITROEN-PEUGEOT-RENAULT</p>	 <p>...1/8... 1/8...A/2 1/8...A/2 ...1/8...A/2 ...1/8...A/2 ...1/8...A/2 ...1/8...A/2 A/2 ...1/8...A/2 M-N-P-R-S</p> <p>NE-36K.P RENAULT</p>	 <p>...1/8... 1/8...A/2 1/8...A/2 ...1/8...A/2 ...1/8...A/2 ...1/8...A/2 ...1/8...A/2 A/2 ...1/8...A/2 M-N-P-R-S</p> <p>NE-36K.P1 CITROEN-PEUGEOT-RENAULT</p>
---	--	---	---

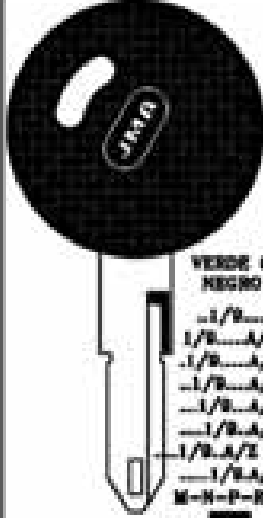
NEIMAN

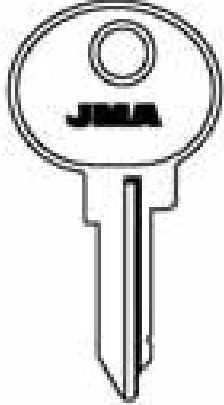
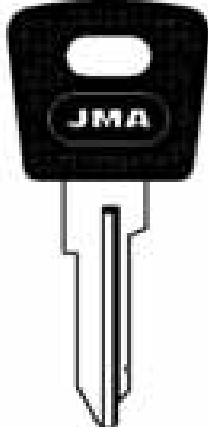
 <p>VERDE O REGNO</p> <p>...1/8... 1/8...A/2 1/8...A/2 ...1/8...A/2 ...1/8...A/2 ...1/8...A/2 ...1/8...A/2 A/2 ...1/8...A/2 M-N-P-R-S</p> <p>NE-38.P RENAULT</p>	 <p>...1/8... 1/8...A/2 1/8...A/2 ...1/8...A/2 ...1/8...A/2 ...1/8...A/2 ...1/8...A/2 A/2 ...1/8...A/2 M-N-P-R-S</p> <p>NE-36.P1 CITROEN-PEUGEOT-RENAULT</p>	 <p>...A/2 1-2-3-4-7</p> <p>NE-37 PEUGEOT</p>	 <p>...A/2 1-2-3-4-7</p> <p>NE-37.P PEUGEOT</p>
---	---	---	--

NEIMAN

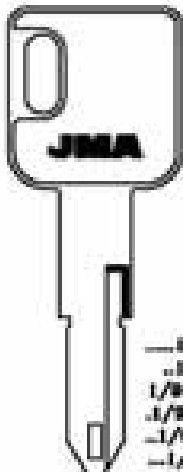
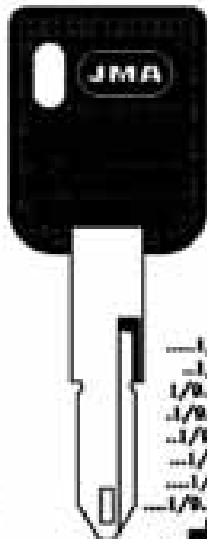
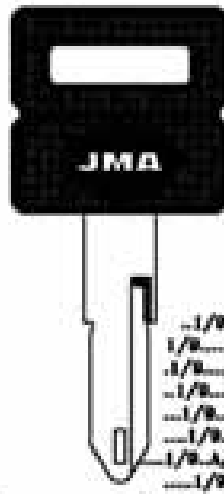
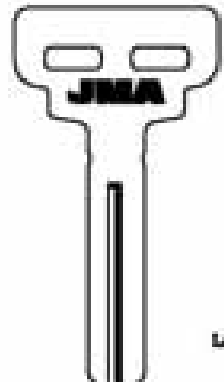
 <p>...1/8...A/2 ...1/8... 1/8...A/2 1/8...A/2 ...1/8...A/2 ...1/8...A/2 ...1/8...A/2 ...1/8...A/2 A/2</p> <p>NE-38 RENAULT</p>	 <p>...1/8...A/2 ...1/8... 1/8...A/2 1/8...A/2 ...1/8...A/2 ...1/8...A/2 ...1/8...A/2 ...1/8...A/2 A/2</p> <p>NE-38.P1 RENAULT</p>	 <p>...1/8... 1/8...A/2 1/8...A/2 ...1/8...A/2 ...1/8...A/2 ...1/8...A/2 ...1/8...A/2 A/2 ...1/8...A/2 M-N-P-R-S</p> <p>NE-39.P PEUGEOT</p>	 <p>LAT.</p> <p>7.5 1 YMOG</p> <p>NE-40</p>
---	--	--	---

Copyright by
Alphatone Alfasud S.A.
1978



196

PARA:
FOR:

NEIMAN

PARA-FOR:

NEIMAN
(F-RA)

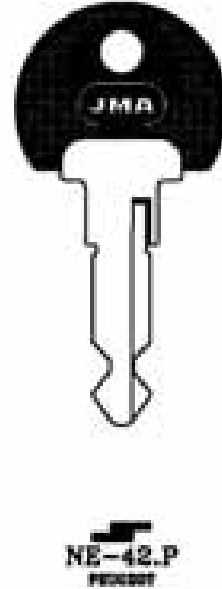
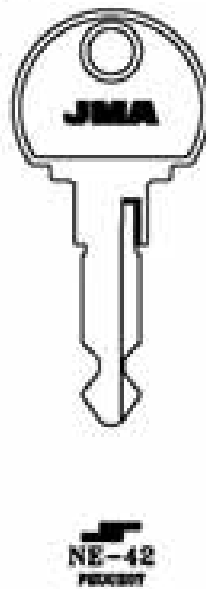
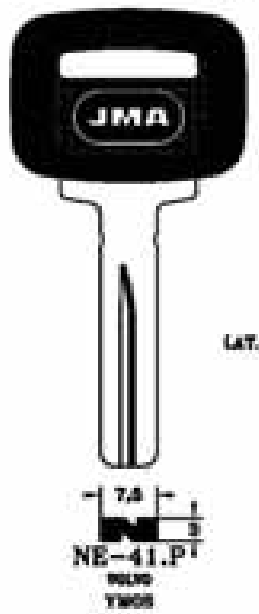
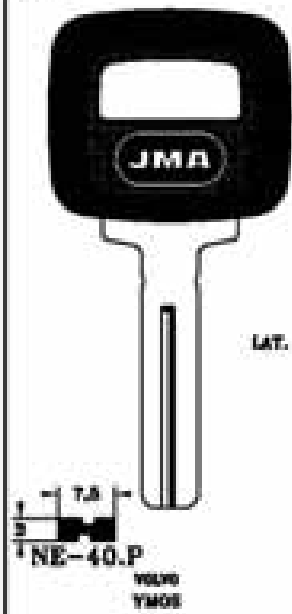

PARA:
FOR:

NEIMAN

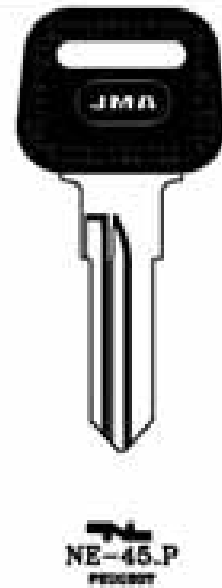
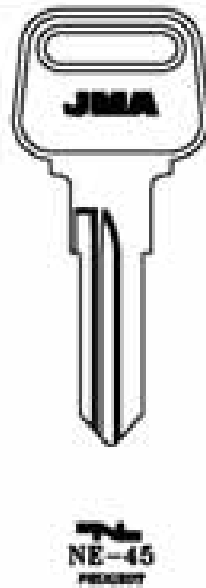
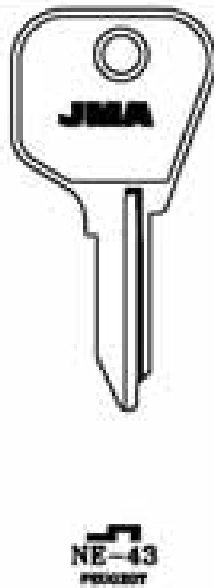
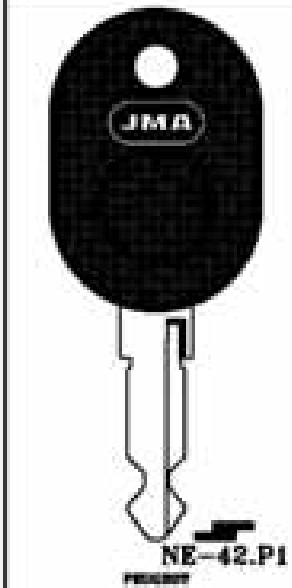

PARA:
FOR:

NEIMAN

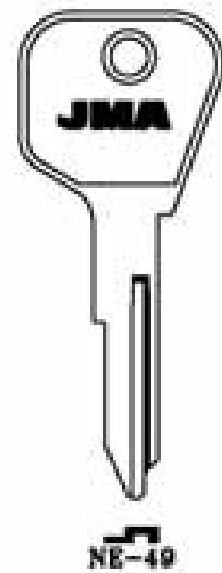
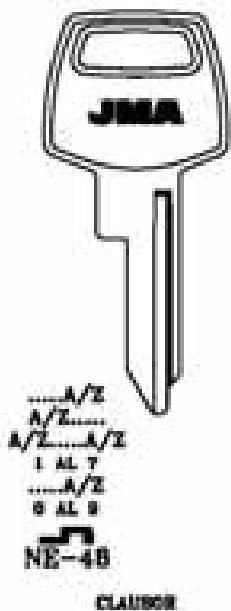
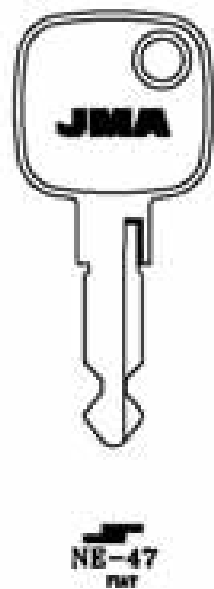
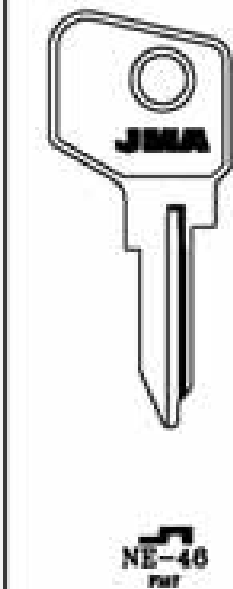

Copyright by
Algebra Alfas S.A.
2010

JMA



197

PARA-FOR:

**NEIMAN
(F-RA)**

PARA-FOR: **NEIMAN**

M,N,T,R,S
1/8...A/2
NE-50.P

ALP.
1 7,8
3,5
NE-51.P2
PROBET
VALERO

L...
5001-10000
NE-52.P
BOYR

PARA-FOR: **NEIMAN**

NE-53

NE-54.P
RENAULT

NE-55.P
RENAULT

1 AL 5
NE-56

PARA-FOR: **NEIMAN**

NE-57
MAZDA

1 AL 5
NE-58D
BOMERO-BORCHI

T...001-999
T...000-999
L...
E...A/2
B-C-D-E-G
NE-59.P
CLAUSON

...1/8...
1/8...A/2
1/8...A/2
...1/8...A/2
...1/8...A/2
...1/8...A/2
...1/8...A/2 1/2
...1/8...A/2
M-N-P-R-S
NE-60C1

Copyright by
Alejandro Allina S.A.
2018

JMA



198

PARA-FOR:

NISSAN (J)

NISSAN

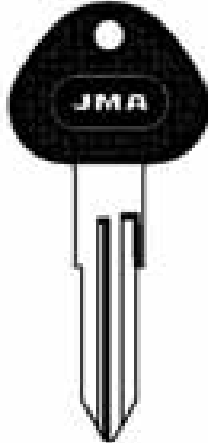

X
0001-8000
DAT-6.P

Y
0001-8000
8001-9000
DAT-7.P

ALFA ROMEO-BELLA-EMMA-EMC-IMPACTO-KERRAN-ORANGE
DATSUN



X
0001-8000
DAT-6.P1

Y
0001-8000
8001-9000
DAT-7.P1

IMPACTO-KERRAN-ORANGE
DATSUN

NISSAN

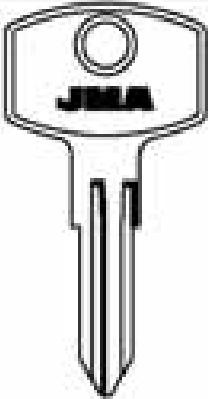

F
0001-1000
1001-2000
M
4001-5000
DAT-8I

M
6001-7000
7001-800
N
0001-1000
DAT-9I

KERRAN-ORANGE
DATSUN

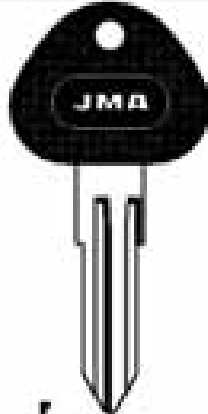

M
0001-1000
5001-6000
N
1001-2000
DAT-8

M
7001-800
DAT-9D

F
0001-1000
1001-2000
M
4001-5000
DAT-8I.P1

KERRAN-ORANGE
DATSUN

NISSAN

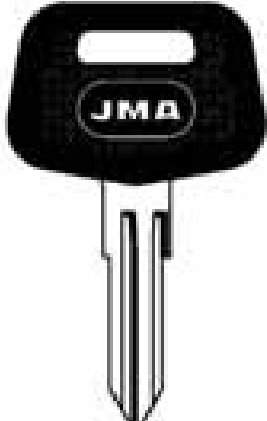

F
0001-1000
1001-2000
M
4001-5000
DAT-8I.P

M
6001-7000
7001-800
N
0001-1000
DAT-9I.P

KERRAN-ORANGE
DATSUN

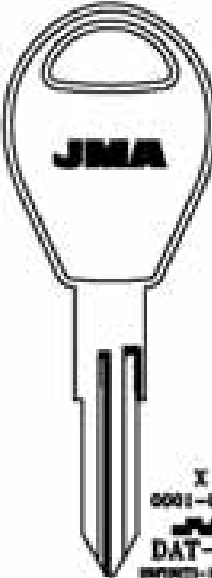

M
0001-1000
5001-6000
N
1001-2000
DAT-8.P

M
7001-800
DAT-9D.P

X
0001-9000
DAT-10

IMPACTO-KERRAN

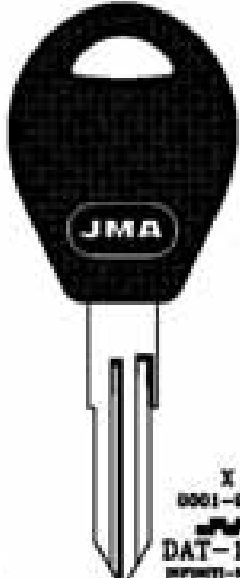

X
0001-9000
DAT-10.P

IMPACTO-KERRAN

Copyright by
Alejandro Allina S.A.
2018

JMA



200

PARA:
FOR:

NISSAN

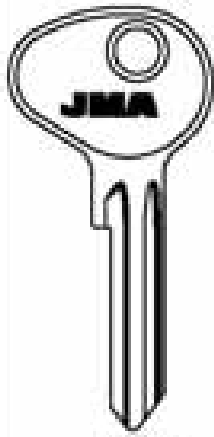

YH
0001-2048
E
00001-14000

DAT-11 DAT-11D
MAZDA-ROVER
DATSUN-BAVO



YH
0001-2048
E
00001-14000

DAT-11.P DAT-11D.P
MAZDA-ROVER
DATSUN-BAVO

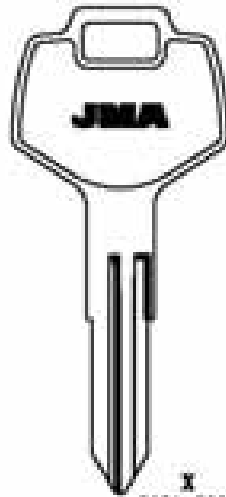

X
0001-8000

DAT-12
MOLDED-NISSAN

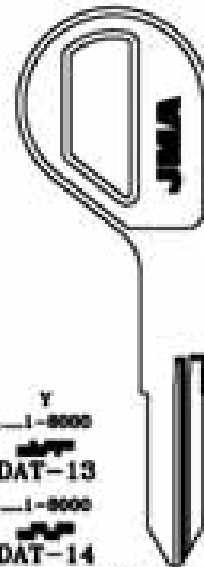

Y
—1-8000

DAT-13

—1-8000

DAT-14

IMPACT

PARA-FOR:

NISSAN (J)

PARA:
FOR:

NISSAN

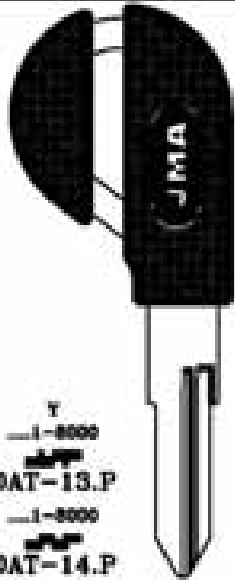

Y
—1-8000
DAT-13.P
—1-8000
DAT-14.P
IMPACT

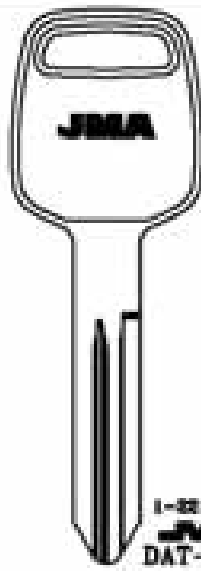

1-22185
DAT-15



VALER
DAT-15C1

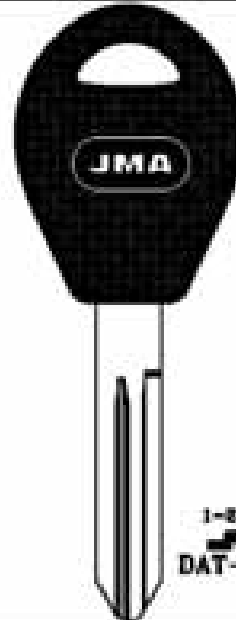

1-22185
DAT-15.P

PARA:
FOR:

NISSAN

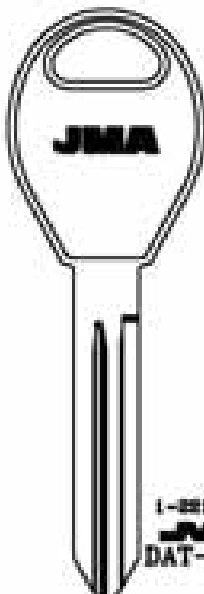

1-22185
DAT-16

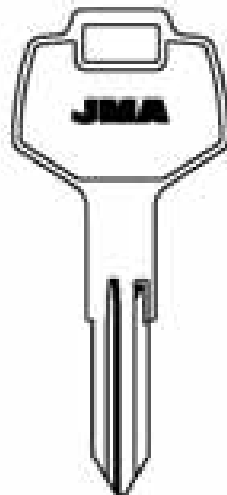

DAT-17 DAT-17D

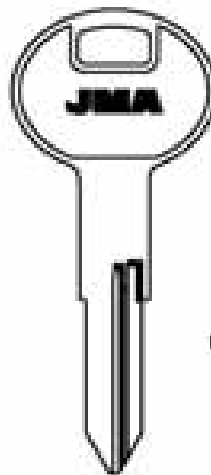

DAT-18

LAT.

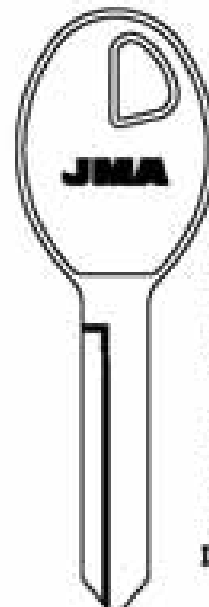

A
101-091
501-079
B
101-032
501-002
C
101-344
501-004
D
101-027
501-002
E
101-096
501-079
DAT-19

Copyright by
Alejandro Allmar S.A.
2018

JMA



201

PARA-FOR:

NISSAN (J)



PGO (J)

PJ (F)

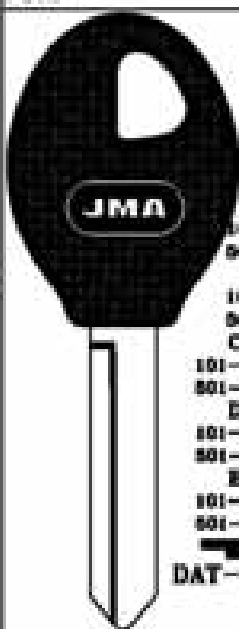
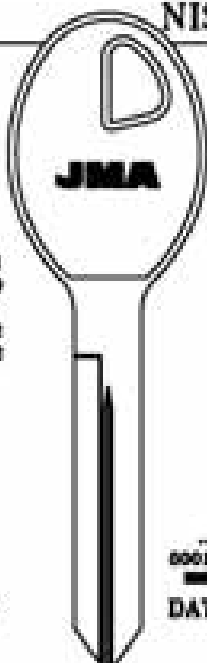
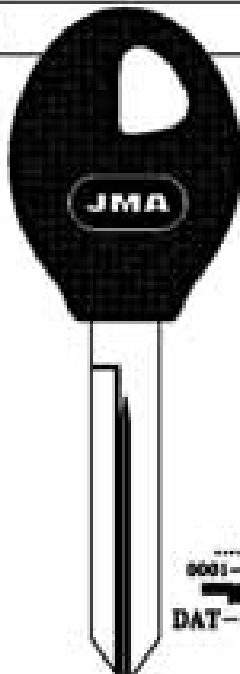
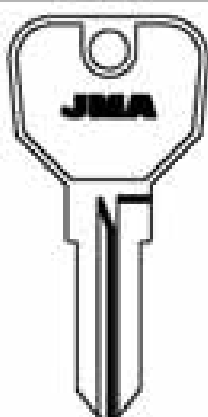
POLLAK (USA)

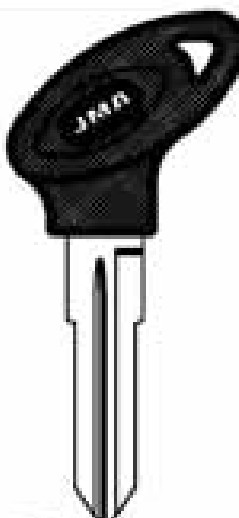
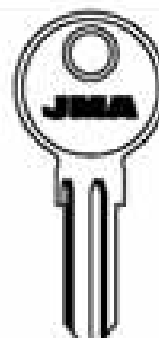
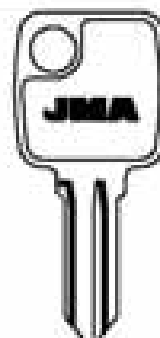
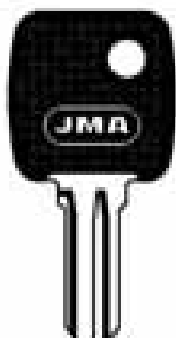
	NISSAN	PGO
 <p>A 101-291 501-279</p> <p>B 101-292 501-282</p> <p>C 101-244 501-224</p> <p>D 101-227 501-202</p> <p>E 101-226 501-279</p> <p>DAT-19.P</p>	 <p>...X 0001-1706</p> <p>DAT-20</p>	 <p>...X 0001-1706</p> <p>DAT-20.P</p>
 <p>PGO-1</p>		

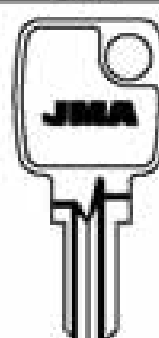
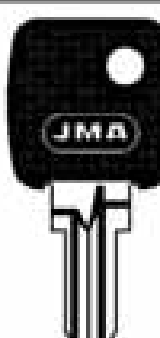
PGO	PJ		
 <p>PGO-2.P</p>	 <p>PJ-1</p> <p>SAF-RENAULT-TALBOT S-VOLEKRAEDER SUPERM</p>	 <p>PJ-2</p> <p>SUPERM</p>	 <p>PJ-2.P</p> <p>SUPERM</p>

PJ	POLLAK		
 <p>PJ-3</p> <p>TALBOT RENEA</p>	 <p>PJ-K</p>	 <p>PJ-K.P</p>	 <p>PLL-1</p> <p>RENAULTE</p>

Copyright by
Allegre Allione S.A.
2010





JMA





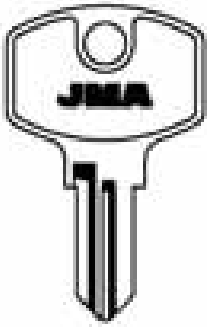
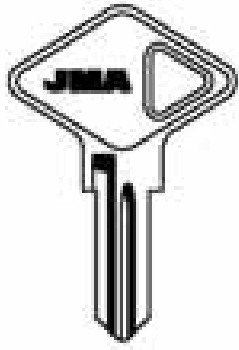
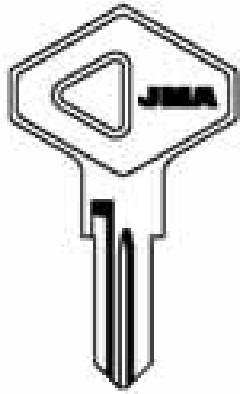
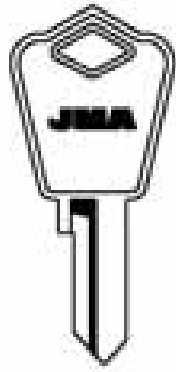





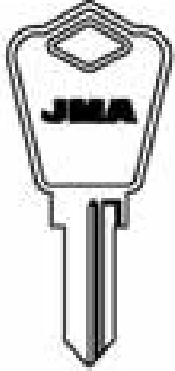
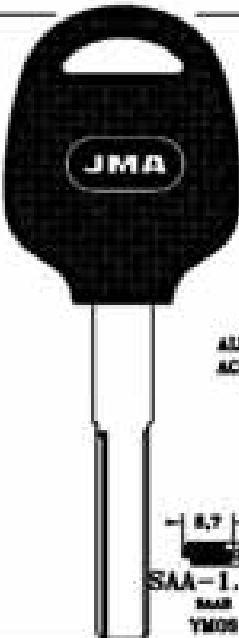
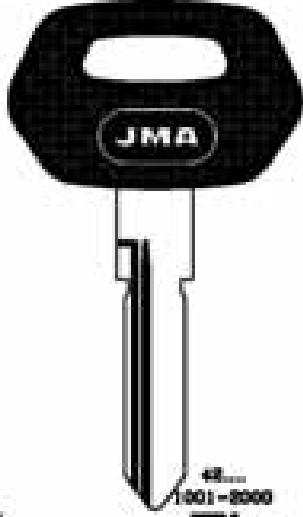
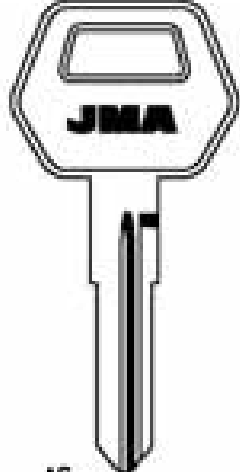



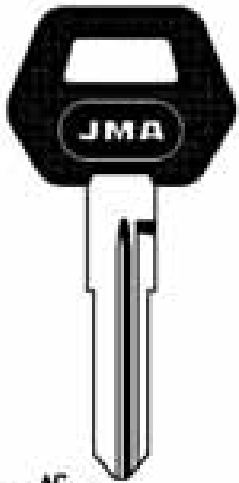

202

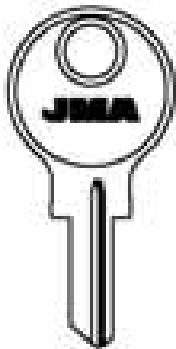
PARA-FOR:

- RONIS (F)
- ROSS (E)
- SAAB (S)
- SAFE (I)

PARA-FOR:	RONIS	ROSS
	  	
	<p>70... I AL 3 ...1-970</p>  RO-14 FERRARI <p>70... I AL 3 ...1-970</p>  RO-15 ACV-ABO BATH-RENAULT <p>77... I AL 3</p>  RO-17 RENAULT	 ROS-1D

PARA-FOR:	SAAB	
	   	
	<p> ROS-2</p> <p>ALP. ACE</p> <p>8,7</p>  SAA-1.P1 SAAB YMOB <p>48... 1001-2000</p>  SAA-2.P <p>AC 1-3190</p>  SAA-AC SAAB YMOB	

PARA-FOR:	SAFE	
	   	
	<p>AC 1-3190</p>  SAA-AC.P SAAB YMOB <p> 15-1  15-D</p> <p>TRAMA-FIST</p> <p> 16-1  16-D</p> <p>A B</p> <p>001-125 001-125</p>  AF-11  AF-1D <p>SAFA BOMBO-AUTOMARCO BIPEA-MACCHETTI MARELLI</p>	

Copyright by
Alpex Alfa S.A.
2018

JMA



204

PARA:
FOR:

SAFE

PARA-FOR:

SAFE (I)

SIMPLEX (F)

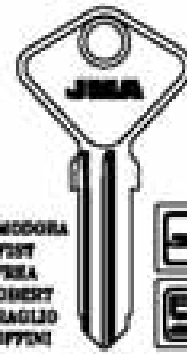
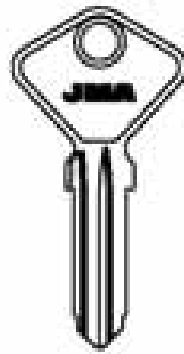
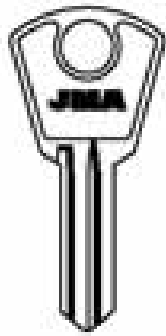

CRIMODORA
FIST
FUEA
GLOBERT
MIRAGLIO
RUFFINI



1
100-200
AF-51

1
100-200
AF-5D

2
100-200
AF-61

4
100-200
AF-6D

0
1-100
AF-21

C
1-100
AF-2D

AF-31

AF-3D

0
010-000
710-700
810-000

D
110-100
210-200
310-000

AF-41

AF-4D

ALFA ROMEO-FIAT
FIAT-TRAMA

ALFA ROMEO-AUTORANCE
SEPEA-MAGNETI MARELLI

PARA:
FOR:

SAFE

SIMPLEX

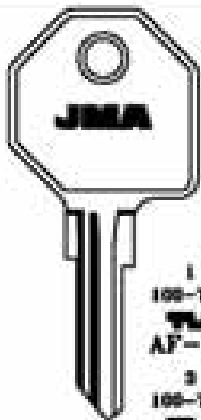

1
100-700
AF-10

2
100-700
AF-11

3
100-700
AF-12

ALFA ROMEO-LANCIA-SABATINI

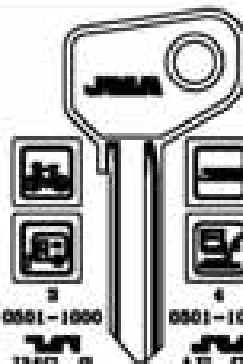

1
0501-1000
IMS-3

2
0501-1000
IMS-5

IMS-13

BLISTER
CRIMODORA-FIAT-DESA



1
0501-1000
IMS-3.P

2
0501-1000
IMS-5.P

IMS-13.P

BLISTER
CRIMODORA-FIAT-DESA

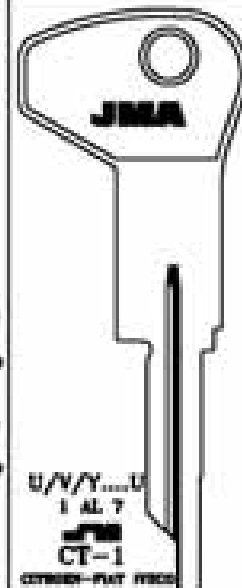

U/V/Y...U
1 AL 7
CT-1

CRIMODORA-FIAT-FIAT
HEIMAN-YACLETTE

PARA:
FOR:

SIMPLEX

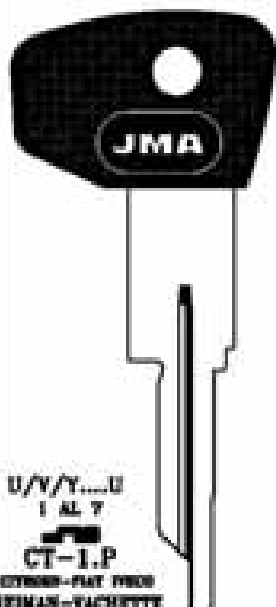

U/V/Y...U
1 AL 7
CT-1.P

CRIMODORA-FIAT-FIAT
HEIMAN-YACLETTE

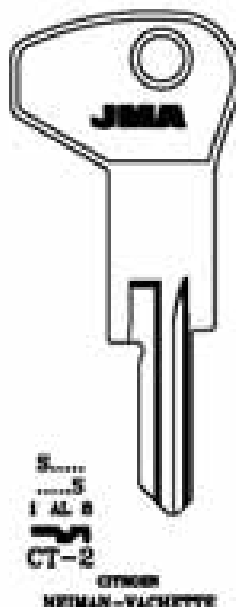

5.....
.....S
1 AL 8
CT-2

CRIMODORA
HEIMAN-YACLETTE

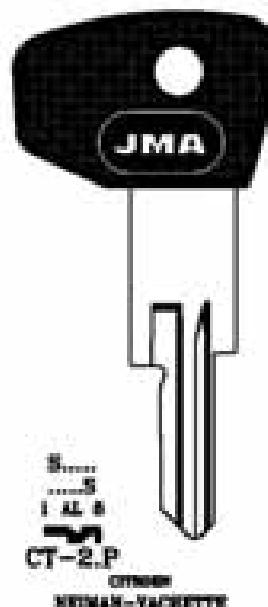

5.....
.....S
1 AL 8
CT-2.P

CRIMODORA
HEIMAN-YACLETTE

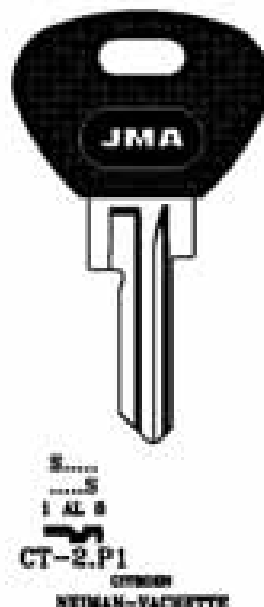

5.....
.....S
1 AL 8
CT-2.P1

CRIMODORA
HEIMAN-YACLETTE

Copyright by
Algebra Alfas S.A.
2010

JMA



205

PARA-FOR:

SIMPLEX (F)

PARA-FOR: **SIMPLEX**

Key 1: B-T....T
1 AL 7
CT-3
CITROEN-MAGNATI-FAT PECO
NEUMAN-YACLETTE

Key 2: B-T....T
1 AL 7
CT-3.P
CITROEN-MAGNATI-FAT PECO
NEUMAN-YACLETTE

Key 3: U/Y/Y....U
1 AL 7
CT-4.P
CITROEN-FAT PECO
NEUMAN-YACLETTE

Key 4:1 AL 8
A/.....1 AL 8
.....1 AL 8
A/.....1 AL 8
SIX-4
SIX-1
SIX-2
CITROEN-PEUGEOT
NEUMAN

PARA-FOR: **SIMPLEX**

Key 1:1 AL 8
A/.....1 AL 8
SIX-1.K.P
CITROEN-PEUGEOT
NEUMAN

Key 2:1 AL 8
A/.....1 AL 8
SIX-4.P
SIX-1.P
SIX-2.P
CITROEN-PEUGEOT
NEUMAN

Key 3:1 AL 8
A/.....1 AL 8
SIX-1.P1
CITROEN-PEUGEOT
NEUMAN

Key 4: A/.....1 AL 8
.....1 AL 8
SIX-1.P2
SIX-2.P2
CITROEN
NEUMAN

PARA-FOR: **SIMPLEX**

Key 1: ALP.
SIX-3.P
CITROEN

Key 2: ALP.
SIX-3.P1
CITROEN-FAT-LANCIA-PEUGEOT

Key 3: ALP.
SIX-3.P2
CITROEN

Key 4: ALP.
SIX-5.P
CITROEN

Copyright by
Alejandro Allina S.A.
2018

JMA



206

PARA:
FOR:

SIPEA

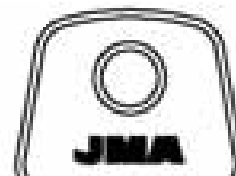
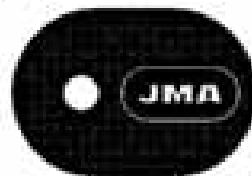
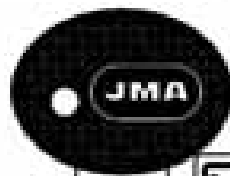

A
0001-3278
0,4,8,8,8

AF-71



AF-7D

A
0001-3278
0,4,8,8,8

AF-71.P

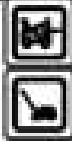

AF-8D.P

B
01-78

AF-81



C
01-78

AF-8D

H
01-78

AF-81.P

G
01-78

AF-8D.P

F
01-78

AF-91



E
01-78

AF-9D

F
01-78

AF-91.P

G
01-78

AF-9D.P

ALFA-AUTOMANCHE-PIAT-LARCA
SAFE

ALFA-AUTOMANCHE-PIAT-LARCA
SAFE

A
0001-3278
0,4,8,8,8
AF-71.P1
PERRAC-PIAT-LARCA/RODRI-GUERRE
NEUMAN

L...001-3278
P...001-3278
SIP-1

PARA-FOR:

SIPEA (I)

SISPA (I)

STREBOR (GB)

PARA:
FOR:

SIPEA

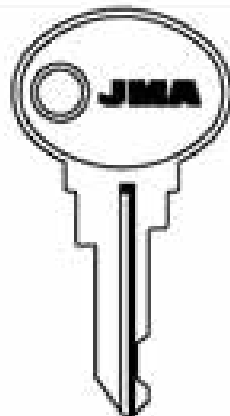
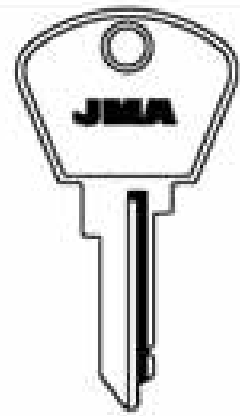

...4-8-8-8

SIP-2

PIAT-PIERRE

MAGNETI MARELLI-NEUMAN

L...001-3278
E...0-4-8-8-8

SIP-3

ALFA-AUTOMANCHE-PIAT-LARCA

ARTES-CLAUDIO-NEUMAN

SISPA

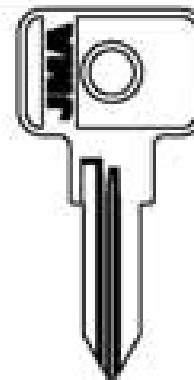

...1100-1307

SI-1D

AUTOBLOCK



SI-3

AUTOBLOCK



SI-2D

SI-3D

AUTOBLOCK

PARA:
FOR:

SISPA

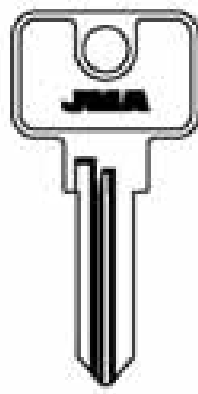

...1100-1307

SI-4

SI-4D

AUTOBLOCK



SI-5D

AUTOBLOCK

STREBOR

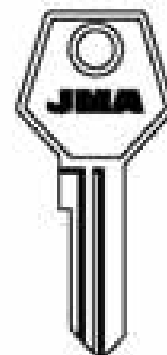
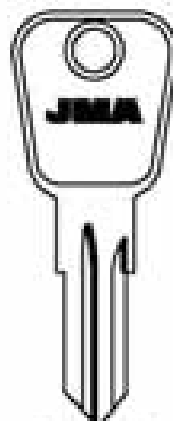

SE...101-199
SE...301-399
SE...501-599
SD...01-99

STR-3

UNION

L...1-78

STR-4

Copyright by
Aljazeera Altesa S.A.
2018

JMA











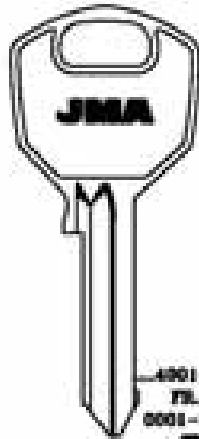
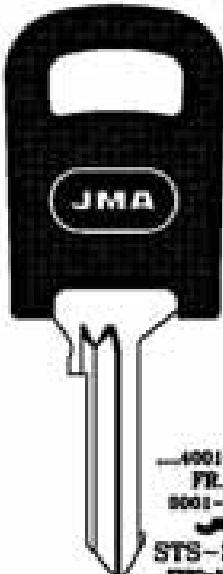
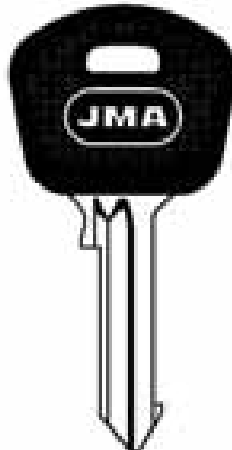
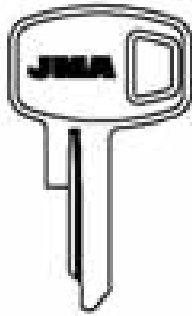



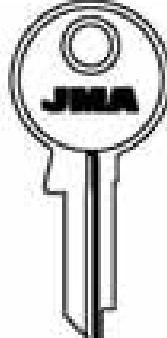

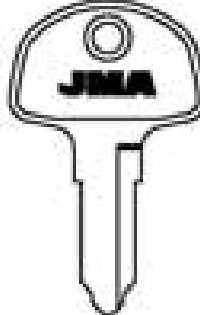



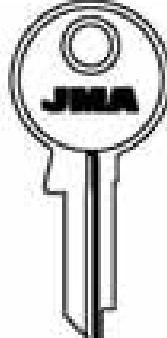

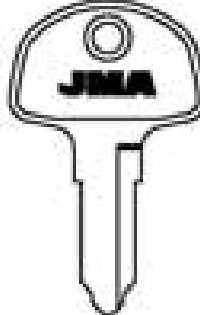
207

PARA-FOR:

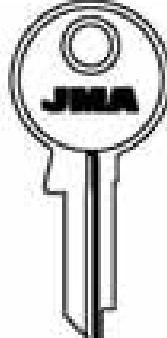
- STS (E)
- SUBARU (J)
- SUZUKI (J)

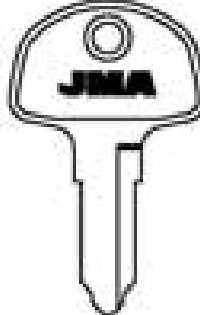
STS

 <p>4001-8000 FR... 0001-0040</p> <p>STS-2D</p> <p>STS-5D</p> <p>END-KEMAR BLACK-50M</p>	 <p>4001-8000 FR... 0001-0040</p> <p>STS-2D.P</p> <p>END-KEMAR BLACK-50M</p>	 <p>STS-5D.P</p> <p>END-KEMAR 50M</p>	 <p>STS-11</p> <p>FRANCE</p>
--	--	---	--

<p>PARA-FOR:</p>  <p>SUBARU</p> <p>ALP.</p> <p>T...1-3000</p> <p>SUB-2.P</p>	<p>SUZUKI</p> <table border="0" style="width: 100%;"> <tr> <td style="text-align: center;">  <p>SUZU-11</p> </td> <td style="text-align: center;">  <p>SUZU-1D</p> </td> <td style="text-align: center;">  <p>SUZU-41</p> </td> </tr> <tr> <td style="text-align: center;">  <p>SUZU-21</p> </td> <td style="text-align: center;">  <p>SUZU-2D</p> </td> <td style="text-align: center;">  <p>SUZU-31</p> </td> </tr> <tr> <td colspan="3" style="text-align: center;"> <p>101-400 701-700 400-400</p> <p>SUZU-41 SUZU-4D</p> <p>ENDS-CADYS-BONDA-KARAMEI LAVEDA-SUZUKA-PELLETT-SUZUKI</p> </td> </tr> </table>	 <p>SUZU-11</p>	 <p>SUZU-1D</p>	 <p>SUZU-41</p>	 <p>SUZU-21</p>	 <p>SUZU-2D</p>	 <p>SUZU-31</p>	<p>101-400 701-700 400-400</p> <p>SUZU-41 SUZU-4D</p> <p>ENDS-CADYS-BONDA-KARAMEI LAVEDA-SUZUKA-PELLETT-SUZUKI</p>		
 <p>SUZU-11</p>	 <p>SUZU-1D</p>	 <p>SUZU-41</p>								
 <p>SUZU-21</p>	 <p>SUZU-2D</p>	 <p>SUZU-31</p>								
<p>101-400 701-700 400-400</p> <p>SUZU-41 SUZU-4D</p> <p>ENDS-CADYS-BONDA-KARAMEI LAVEDA-SUZUKA-PELLETT-SUZUKI</p>										

SUZUKI

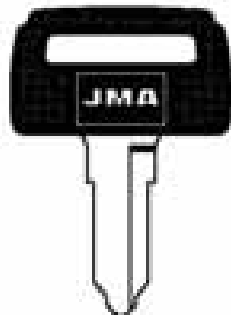
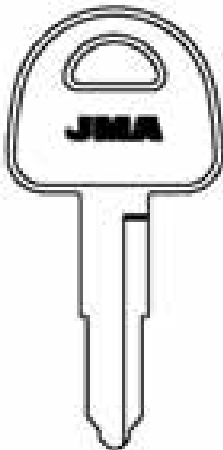
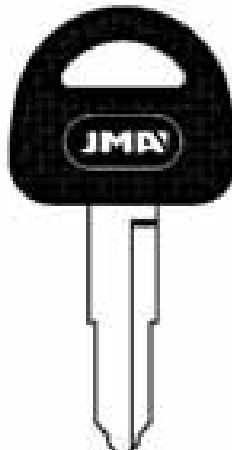
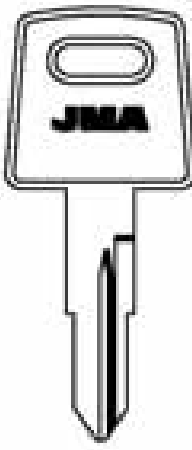
 <p>101-400 701-700 400-400</p> <p>SUZU-41.P SUZU-4D.P</p> <p>ENDS-CADYS-BONDA-KARAMEI LAVEDA-LOCUSTA-PELLETT-SUZUKI</p>	 <p>101-400 701-700</p> <p>SUZU-5</p> <p>ENDS-SUZUKI</p>	 <p>101-400 701-700</p> <p>SUZU-5.P</p> <p>ENDS-SUZUKI</p>	 <p>4 001-100</p> <p>SUZU-6</p>
--	--	---	---

Copyright by
Algebra Alfas S.A.
1978

JMA



208

PARA:
FOR:

SUZUKI

PARA-FOR:

SUZUKI (J)

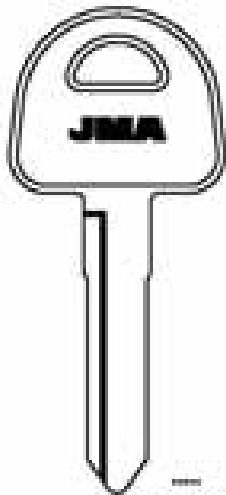

18001-17704

SUZU-7

CH-NARUTO-SUZUKI

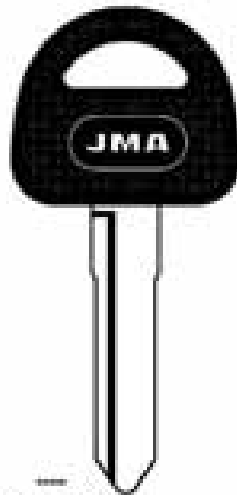

18001-17704

SUZU-7.P SUZU-7D.P

CH-NARUTO-SUZUKI

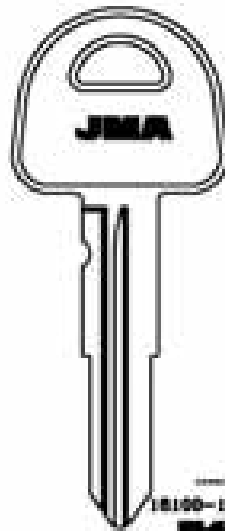

18100-18000

SUZU-8

SUZUKI

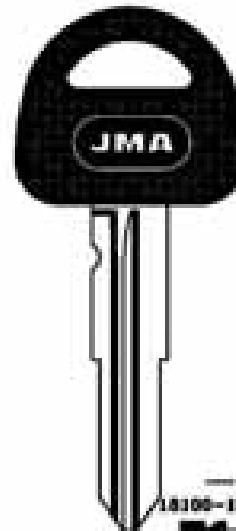

18100-18000

SUZU-8.P

SUZUKI

PARA:
FOR:

SUZUKI

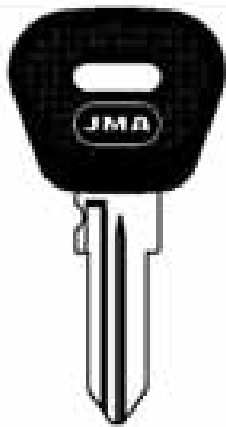

1-2000

SUZU-9.P

SUZUKI
CLAUSON

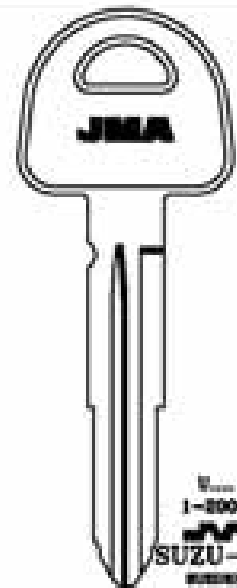

1-2000

SUZU-10

SUZUKI

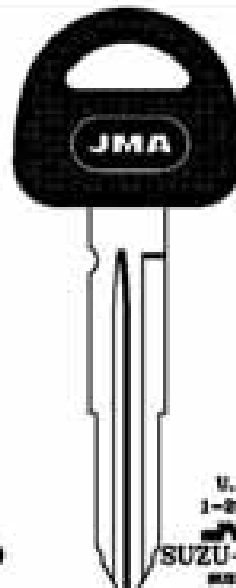

1-2000

SUZU-10.P

SUZUKI

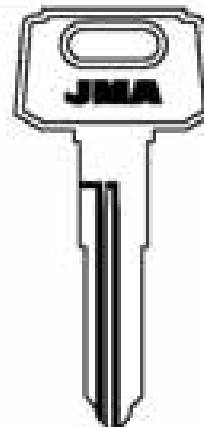

6001-7000

SUZU-11D

SUZUKI

PARA:
FOR:

SUZUKI

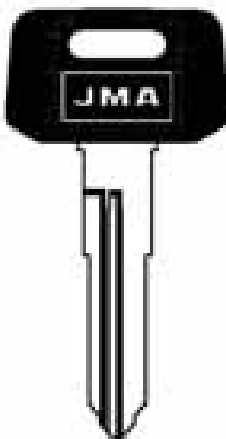

6001-7000

SUZU-11D.P

SUZUKI

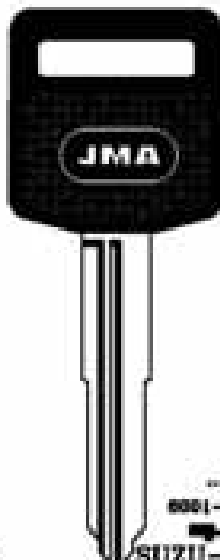

6001-7000

SUZU-12D.P

SUZUKI

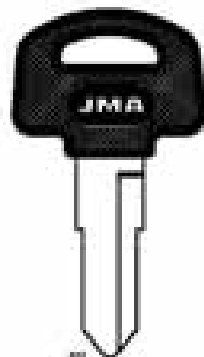

101-400
781-795
800-890

SUZU-13.P

SUZU-13D.P

SUZUKI-CAGIVA-BOMBA-SARAGNO
LAFERRA-LUCINI-PEUGEOT-SUZUKI

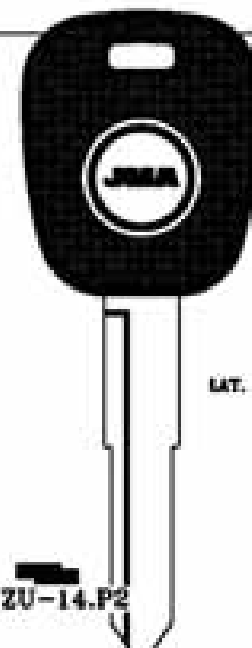

LAT.

Copyright by
Algebra Altesa S.A.
2018

JMA

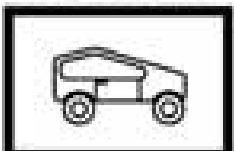

209

PARA-FOR:

TAP-AGIS (YU)



TATA (IND)





TECUMSEH (A)

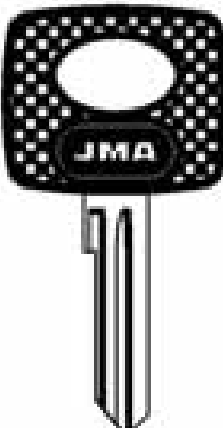

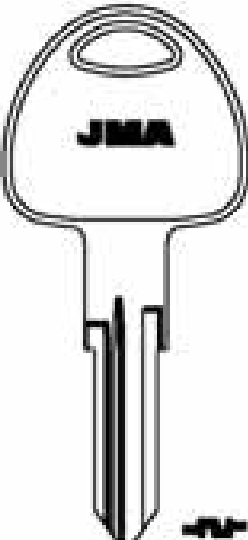
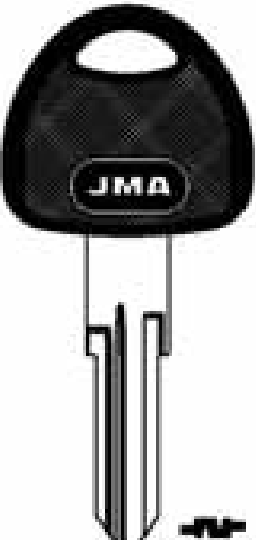
TIBBE (D)

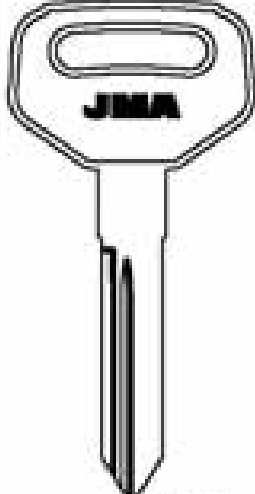
TITAN (YU)

TOYOTA (J)

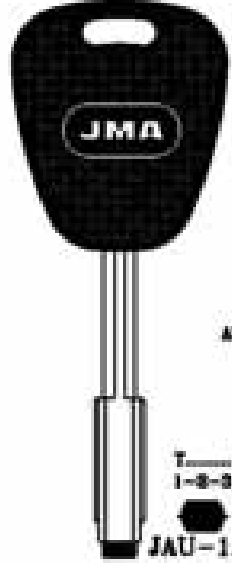
<p>PARA-FOR: TAP-AGIS</p> <div style="display: flex; justify-content: space-around;">   </div> <div style="display: flex; justify-content: space-around; margin-top: 20px;"> <p>TAP-1P</p> <p>TAP-2</p> </div>	<p>TATA</p> <div style="display: flex; justify-content: space-around;">   </div> <div style="display: flex; justify-content: space-around; margin-top: 20px;"> <p>TAT-1D</p> <p>TAT-1D.P</p> </div>
---	---

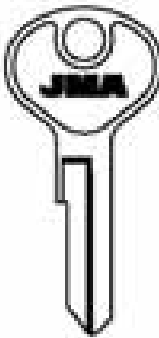
<p>PARA-FOR: TATA</p> <div style="display: flex; justify-content: space-around;">   </div> <div style="display: flex; justify-content: space-around; margin-top: 20px;"> <p>TAT-2D</p> <p>TAT-2D.P</p> </div>	<p>TECUMSEH</p> <div style="text-align: center;">  </div> <div style="text-align: center; margin-top: 20px;">  <p>TEU-1</p> <p>INDIAE</p> </div>	<p>TIBBE</p> <div style="text-align: center;">  </div> <div style="text-align: center; margin-top: 20px;"> <p>ALP.</p> <p>T... 1-8-3</p> <p>JAU-1.P</p> </div>
--	--	---

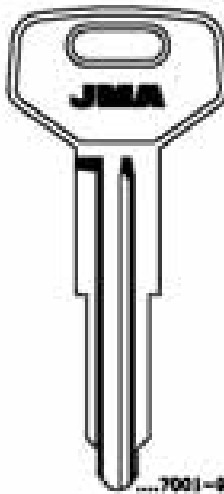
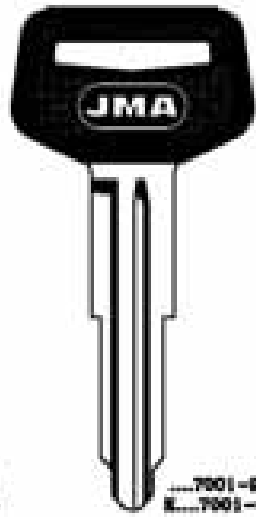
<p>PARA-FOR: TITAN</p> <div style="text-align: center;">  </div> <div style="text-align: center; margin-top: 20px;"> <p>TIT-7D</p> </div>	<p>TOYOTA</p> <div style="display: flex; justify-content: space-between;"> <div style="width: 45%;"> <p>A... 0001-0400 2221-2500 4441-4840</p> <p>B... 6001-6000</p> <p>C... 6001-7000</p> <p>M... 5551-5050 6661-7000 7771-8170 8814-9280</p> <p>N... 1821-2280</p> </div> <div style="width: 45%;">  <p>TOYO-2 IND-TOYOTA TORAJ-BIRA</p> </div> </div>	<div style="display: flex; justify-content: space-around;"> <div style="width: 45%;">  <p>TOYO-3 BANGKALU-TOYOTA TORAJ-BIRA</p> </div> <div style="width: 45%;">  <p>TOYO-3.P BANGKALU-TOYOTA TORAJ-BIRA</p> </div> </div>
---	--	---

Copyright by
Algenbris Altriss S.A.
2008

JMA



210

PARA:
FOR:

TOYOTA

PARA-FOR:

TOYOTA (J)

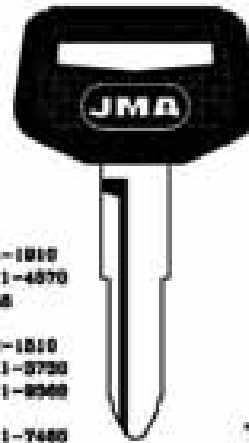
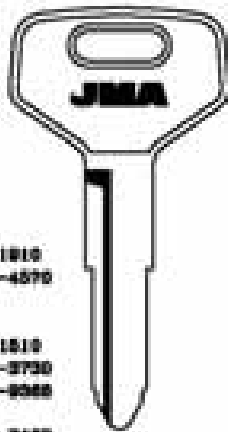

K...
001-400/1811-1810
0021-0020/3731-4570
0001-0000

F...
401-000/1112-1810
0021-0020/3731-4570
0001-0004/0001-0000

E...
0051-0050/7001-7400
0171-0070/0001-0000

D...
0001-7042

TOYO-K1

BMWFOR-BMWALFA-ROMEO-SKODAFORD-SEATVAUX-DAEWOO-LUTON-SEAT-SEAT-SEAT

TOKAJ-BEKA

F...
0061-0060
7001-7400
0171-0070
0021-0020

F...
7001-0000

TOYO-4

C...
0001-7042

TOYO-14

K...
001-400/1811-1810
0021-0020/3731-4570
0001-0000

F...
401-000/1112-1810
0021-0020/3731-4570
0001-0004/0001-0000

E...
0051-0050/7001-7400
0171-0070/0001-0000

D...
0001-7042

TOYO-K1.P

BMWFOR-BMWALFA-ROMEO-SKODAFORD-SEATVAUX-DAEWOO-LUTON-SEAT-SEAT-SEAT

TOKAJ-BEKA

F...
0061-0060
7001-7400
0171-0070
0021-0020

F...
7001-0000

TOYO-4.P

C...
0001-7042

TOYO-14.P

PARA:
FOR:

TOYOTA

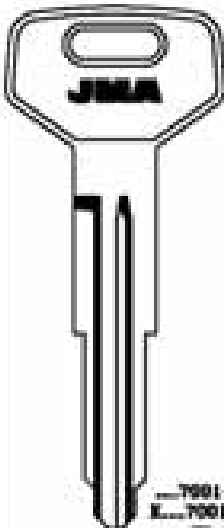

...7001-0000
E...7001-0000

TOYO-5

TOYOTA
TOKAJ-BEKA

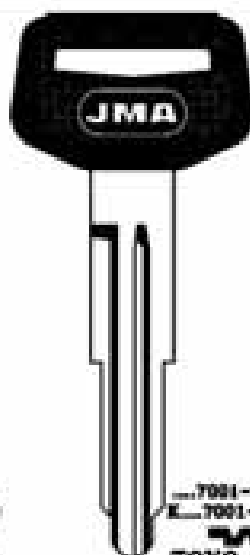

...7001-0000
E...7001-0000

TOYO-5.P

TOYOTA
TOKAJ-BEKA

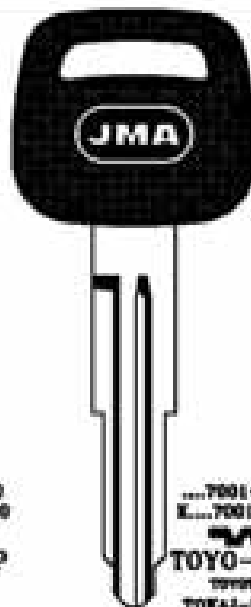

...7001-0000
E...7001-0000

TOYO-5.P1

TOYOTA
TOKAJ-BEKA

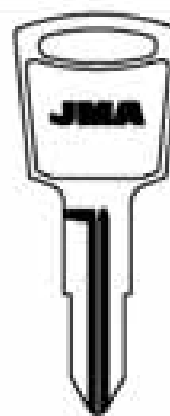

TOYO-8

TOYOTA
TOKAJ-BEKA

PARA:
FOR:

TOYOTA

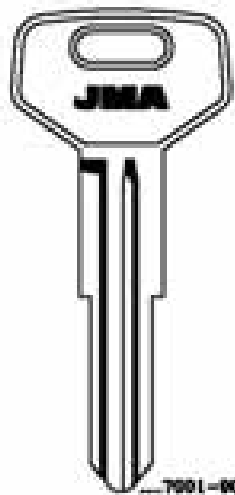

...7001-0000
E...7001-0000

TOYO-8

DAEWOO-TOYOTA
TOKAJ-BEKA

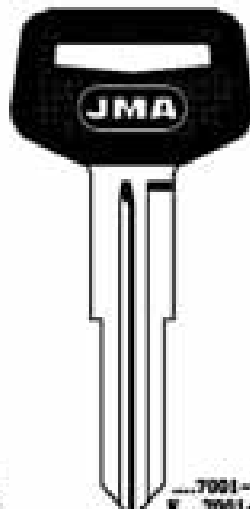

...7001-0000
E...7001-0000

TOYO-8.P

DAEWOO-TOYOTA
TOKAJ-BEKA

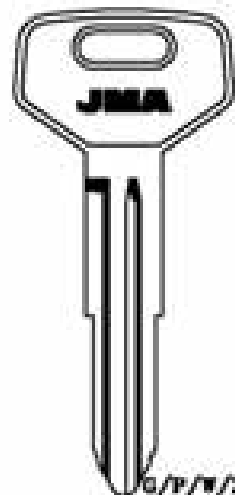

G/P/R/L...
1-0000

TOYO-9

TOYOTA-VALENTINO
TOKAJ-BEKA

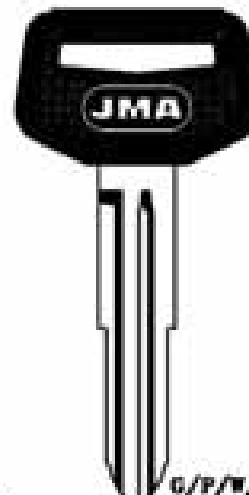

G/P/R/L...
1-0000

TOYO-9.P

TOYOTA-VALENTINO
TOKAJ-BEKA

Copyright by
Algebra Almas S.A.
2010

JMA



211

PARA-FOR:

TOYOTA (J)

PARA-FOR:

TOYOTA

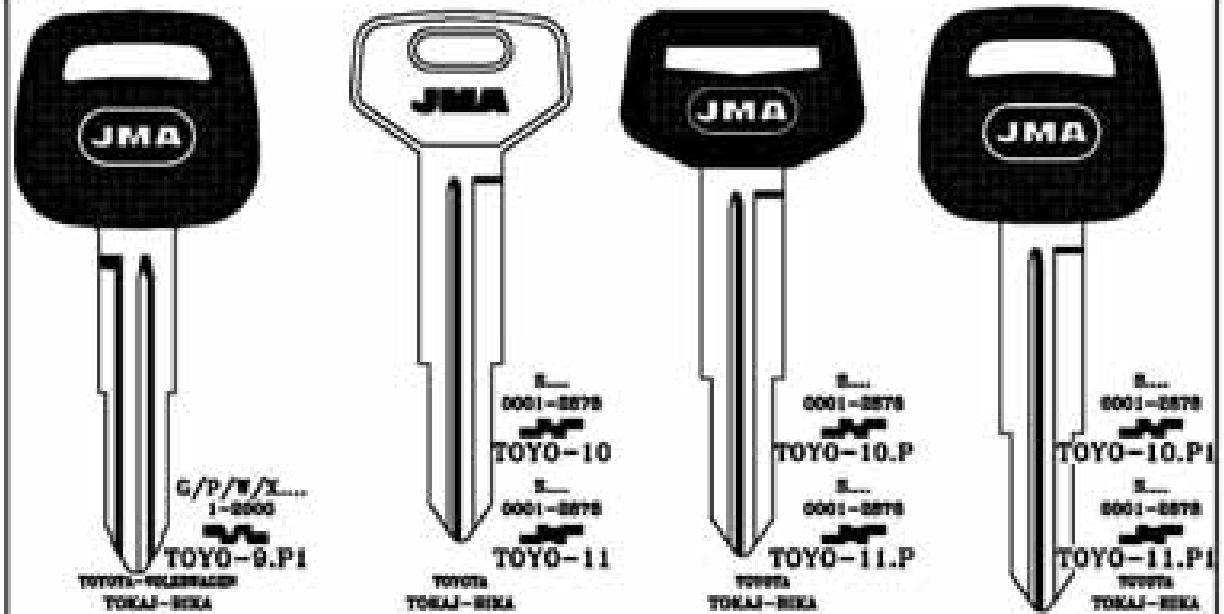

PARA-FOR:

TOYOTA

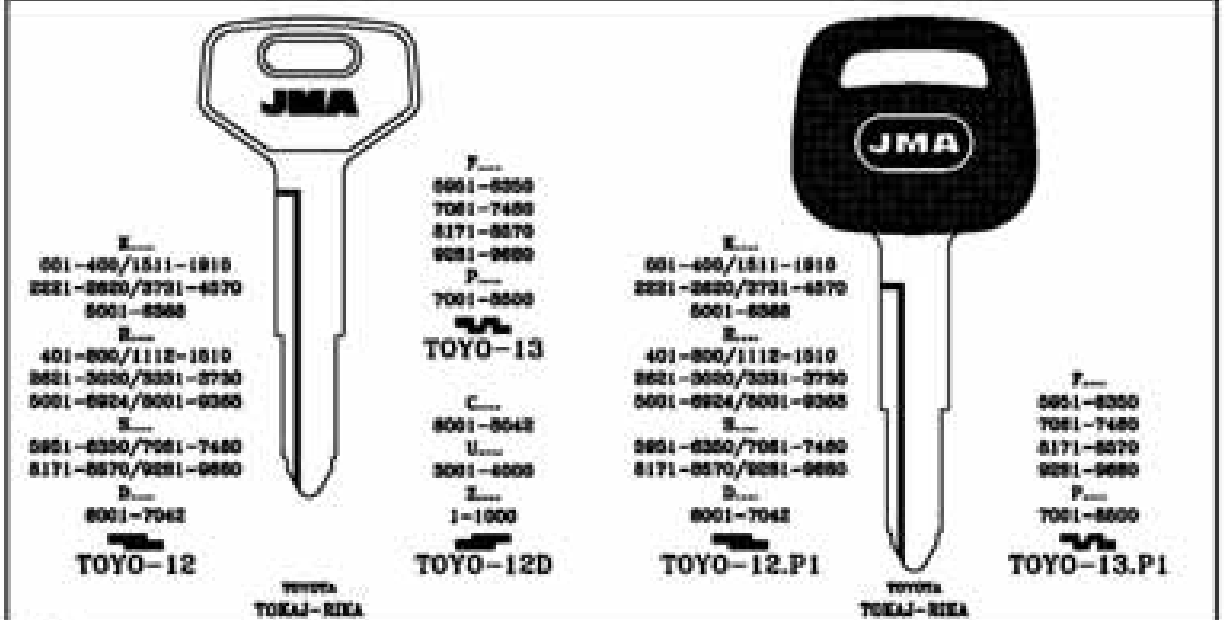

PARA-FOR:

TOYOTA

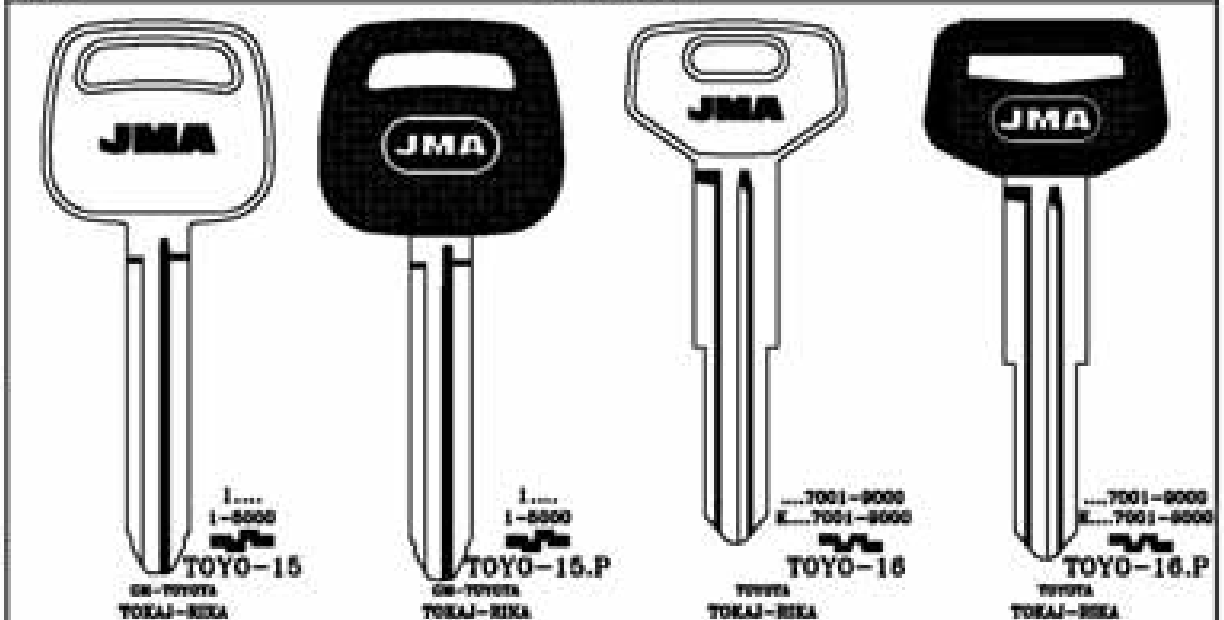

Copyright by
Alejandro Altamir S.A.
2018

JMA

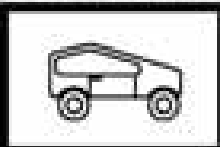

212

PARA:
FOR:

TOYOTA

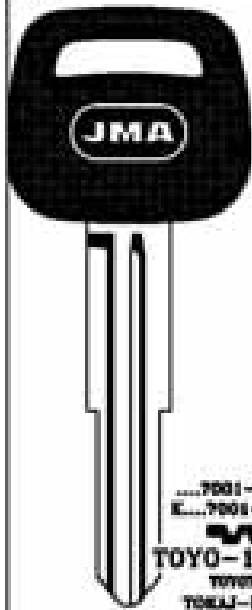

...7001-9000
E...7001-9000
TOYO-16.P1
TOYOTA
TOKAJ-SIEKA

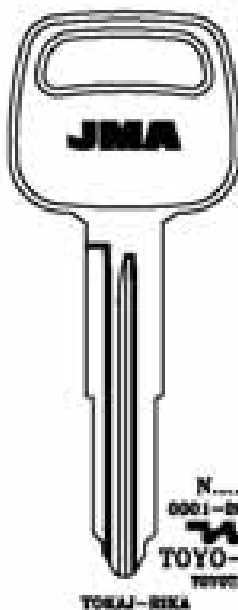

N...
0001-2000
TOYO-17
TOYOTA
TOKAJ-SIEKA

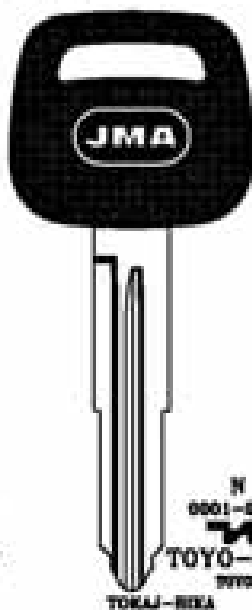

N
0001-2000
TOYO-17.P
TOYOTA
TOKAJ-SIEKA



LAT.
1-7,8
3
TOYO-18.P
LITVA-SAKSIA-TOYOTA
TOKAJ-SIEKA

PARA:
FOR:

TOYOTA

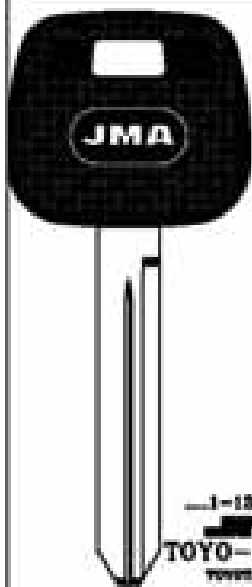

...1-12284
TOYO-19.P
TOYOTA
VALDO

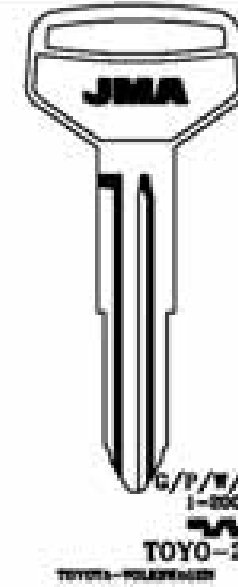

G/P/W/X...
1-2000
TOYO-20D
TOYOTA-POLENSKIA
TOKAJ-SIEKA

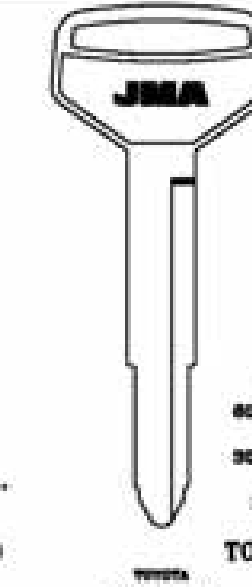

C...
0001-2042
U...
0001-4000
E...
1-1000
TOYO-22
TOYOTA
TOKAJ-SIEKA

E...
001-400/1811-1810
0001-2000/3701-4070
0001-2000
E...
401-800/1112-1810
0001-3000/3301-3700
0001-0004/0001-0000
E...
0001-2000/7001-7400
0171-0070/0001-0000
D...
0001-7042
TOYO-22D

PARA:
FOR:

TOYOTA

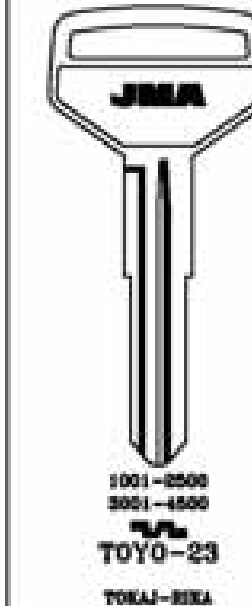

1001-2500
3001-4500
TOYO-23
TOKAJ-SIEKA

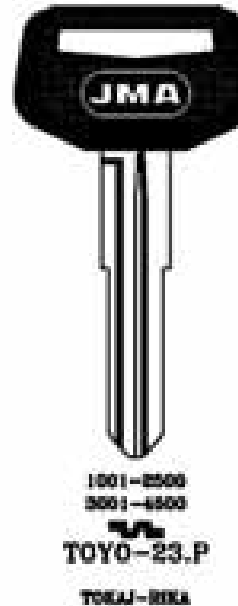

1001-2500
3001-4500
TOYO-23.P
TOKAJ-SIEKA

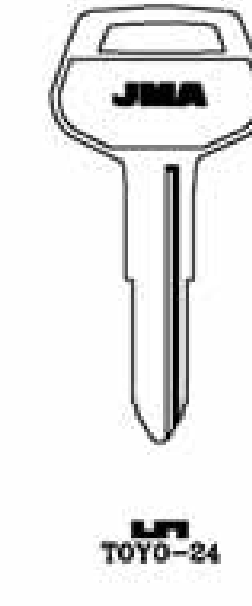

TOYO-24

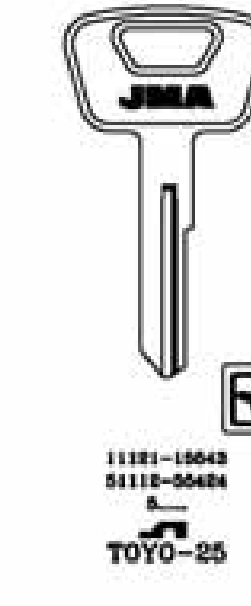

11101-15042
51112-55424
D...
TOYO-25

PARA-FOR:

TOYOTA (J)

Copyright by
Aljezandro Aljeza S.A.
2018

JMA



213

PARA:
FOR:

UNION

PARA-FOR:

UNION (GB)

VACHETTE (F)

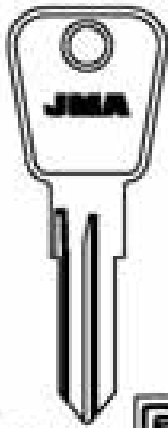

FT-BC...301-360
 BC-FT...101-225
 LP...451-575
 CB...801-875

TF
 TF...1001-1145

UN-FT
 UN-TF

REYNOLDS-SLETTLAND-FORD
 CEM



NC...
 1-1000

UN-NC

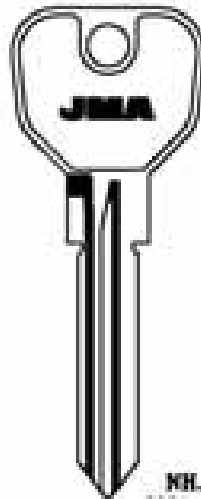

NH...
 2001-3000

UN-NH

MC-SIYER-TALBOT
 CEM

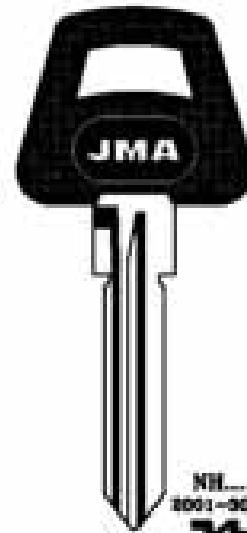

NH...
 3001-3000

UN-NH.P

MC-SIYER-TALBOT
 CEM

PARA:
FOR:

VACHETTE

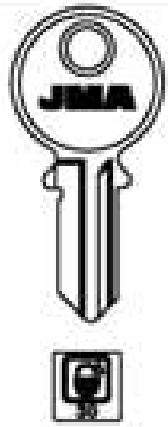

...I AL 0 AL 0
 E...9001-9100
 ...20001-2100

VA-31
 VA-3

REO-ELIT

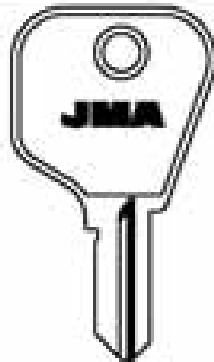

E...
 001-848

VA-8

CYRUS-PEUGEOT-TALBOT BORG
 SIMPLEX

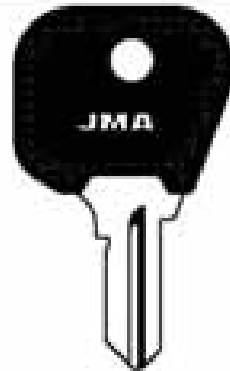

E...
 001-848

VA-8.P

CYRUS-PEUGEOT-TALBOT BORG
 SIMPLEX

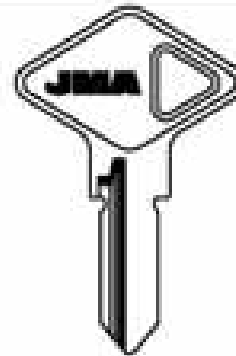

IR...000-999
 SR...1000-1837
 SR...000-600

VA-7

RENAULT-TALBOT BORG

PARA:
FOR:

VACHETTE

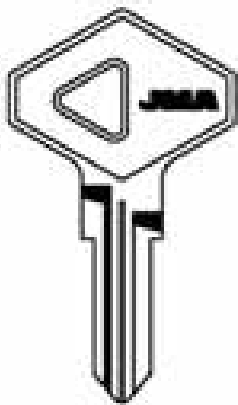

A/Z...
 ...A/Z
 ...A/Z 1/2
 2700-2818

VA-10

LAUREN-CHRYSLER-RENAULT

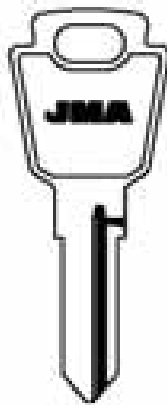

A...000-999
 E...000-999
 F...000-118

VA-16

TALBOT BORG



LAT.

...A/Z
 A/Z...A/Z
 1000-2000
 E...A/Z 0 AL 4

VA-17.P

RENAULT
 NETVAN

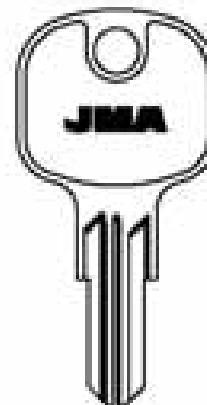

...E
 001-848

VA-18

PEUGEOT

Copyright by
Alphatone Alfasud S.A.
2018

JMA



215

PARA-FOR:

VACHETTE (F)

VALEO (F)

VOLGA (RUS)

PARA-FOR: **VACHETTE**

...A/Z 0/0
1-4000
...A/Z 0/0
5001-9000
...A/Z 0/0
1-4000
...A/Z 0/0
5001-9000
VA-34
RENAULT

...A/Z 0/0
1-4000
...A/Z 0/0
5001-9000
...A/Z 0/0
1-4000
...A/Z 0/0
5001-9000
VA-34.P
RENAULT

AZUL
BLUE

...A/Z 0/0
1-4000
...A/Z 0/0
5001-9000
...A/Z 0/0
1-4000
...A/Z 0/0
5001-9000
VA-34.P1
RENAULT

...A/Z 0/0
1-4000
...A/Z 0/0
5001-9000
...A/Z 0/0
1-4000
...A/Z 0/0
5001-9000
VA-61C1

PARA-FOR: **VACHETTE**

...A/Z 0/0
1-4000
...A/Z 0/0
5001-9000
...A/Z 0/0
1-4000
...A/Z 0/0
5001-9000
VA-61C2

VALEO

ALP.

ALP.

ALP.

HU-HAAC3

HU-HAAC4

PEU-1C1

PARA-FOR: **VALEO**

ALP.

PEU-2C1

VOLGA

VOL-2

VOL-2D

VOL-1

VOL-1.P

VOL-3

GAZ-EAZ

Copyright by
Alejandro Allina S.A.
2018

JMA

216

PARA:
FOR:

VOLGA

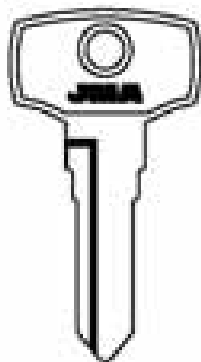

VOL-4

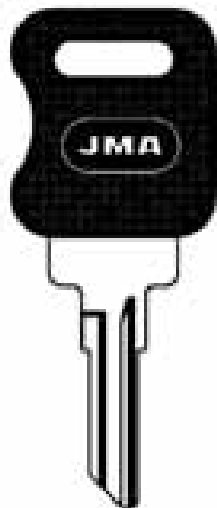

VOL-5.P

WASO

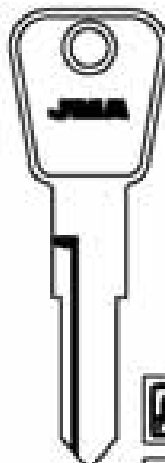

WAS-1
LACIAS-BAYER-SIAB-VOLVO

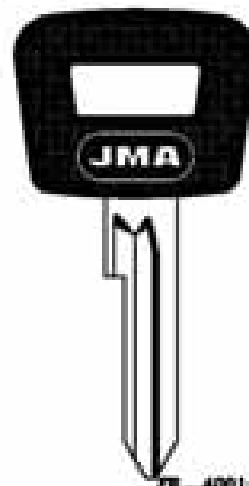

WAS-2.P
LACIAS-BAYER-SIAB-VOLVO
ARMAN-DSM

PARA-FOR:

VOLGA (RUS)

WASO (D)

PARA:
FOR:

WASO



WAS-3
L...1-4000
D...1-4000
E...1-4000
WAS-4



WAS-3.P
L...1-4000
D...1-4000
E...1-4000
WAS-4.P

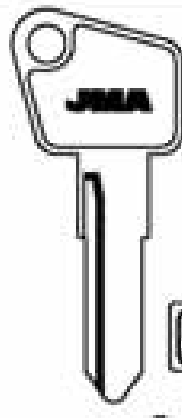

WAS-5
L...800-842
M...100-174
WAS-6

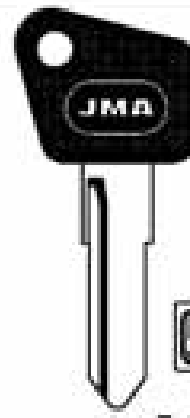

WAS-5.P
L...800-842
M...100-174
WAS-6.P

PARA:
FOR:

WASO

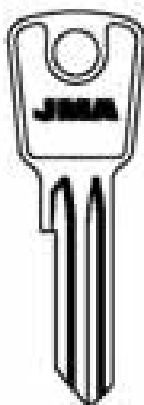

WAS-71
A... 0 AL 5
L... 0 AL 5
WAS-7D

TOE

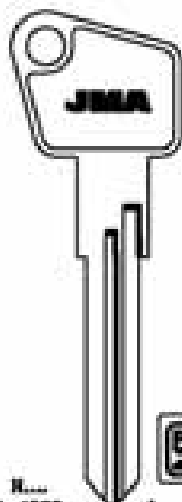

WAS-8
L... 1-4000
A...
WAS-8D

UNIPART



WAS-9
L... 0 AL 5
L... 0 AL 5
WAS-9D

TOE WINDHAUS

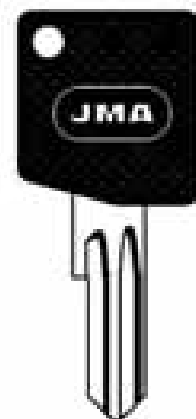

WAS-10.P
WAS-10D.P

TRELOCK

Copyright by
Allegre Almas S.A.
2018

JMA

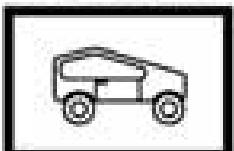









PARA-FOR:

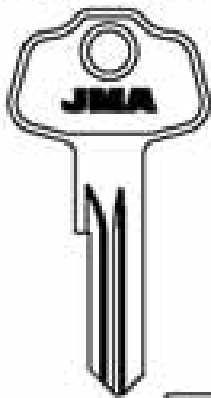

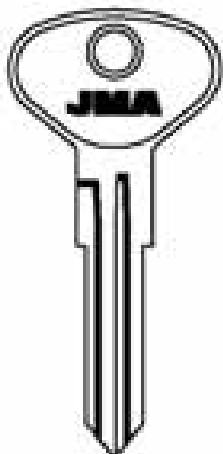

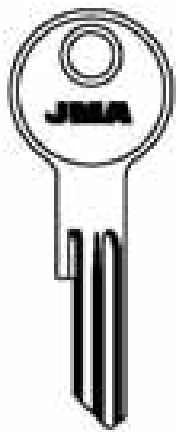

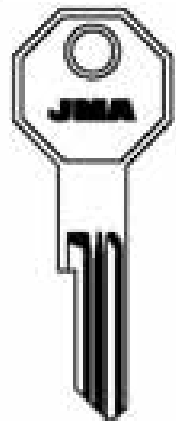



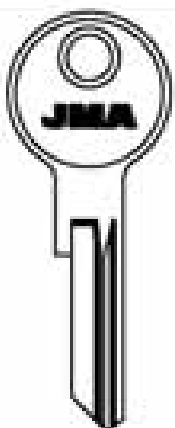

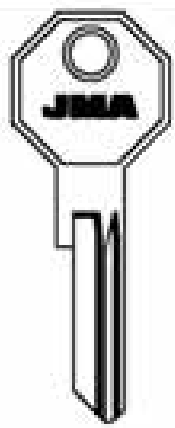

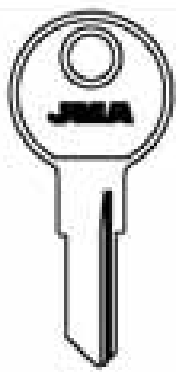

**WEST LOCK
(USA)**







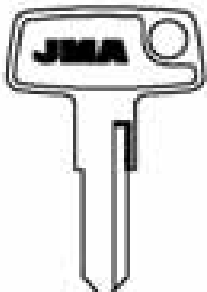

WITTE (D)

**YALE
(D-GB-USA)**

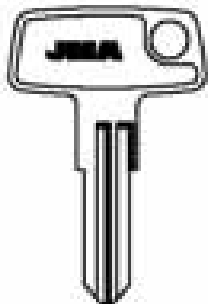
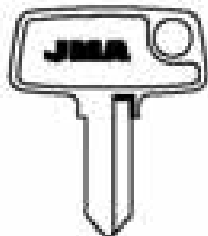
YAMAHA (J)

PARA FOR: WEST LOCK	WITTE	YALE	
  V... 1 AL 6  WST-2D	 0001-0100  WIT-1	 HXEL  YA-18D BULLS BOWCE	 HXEM  YA-19D BULLS BOWCE

PARA FOR: YALE			YAMAHA
 HXEL  YA-20I	 HXEM  YA-21I	  YA-37	 0040-0047  YAMA-1I
 HXEM  YA-20D BULLS BOWCE	 HXEM  YA-21D BULLS BOWCE	 HXEM  YA-37D AGENCO-SEVRO-CHICAGO FORT-ILLINOIS	0700-0707  YAMA-1D
			0040-0047  YAMA-2I
			0040-0047  YAMA-2D YAMAHA

PARA FOR: YAMAHA			
			
0011-0040  YAMA-3I	1751-1755  YAMA-3D YAMAHA	0051-0075  YAMA-4D YAMAHA	1751-1775  YAMA-5I
			005-024  YAMA-6I
			001-027  YAMA-6D YAMAHA

Copyright by
Alpandre Allmax S.A.
2018

JMA



218

PARA:
FOR:

YAMAHA

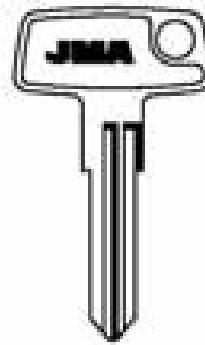
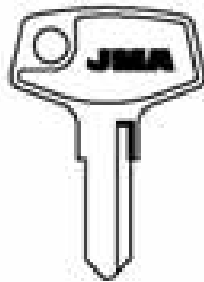
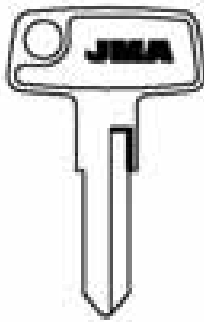

2676-2750
YAMA-7I
YAMA-7D
YAMA

2169-2116
2611-2625
2201-2212
1809-1818
1711-1725
4301-4112
YAMA-8I
YAMA-8D
YAMA

2201-2208
2001-2008
4101-4108
2101-2108
YAMA-9I
YAMA-9D
YAMA

2760-2771
1850-1861
YAMA-10I
YAMA-10D
2760-2764
1848-1854
YAMA-11I
YAMA-11D
YAMA

PARA-FOR:

YAMAHA (J)

PARA:
FOR:

YAMAHA

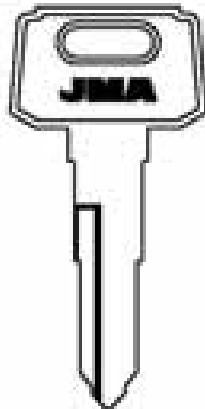
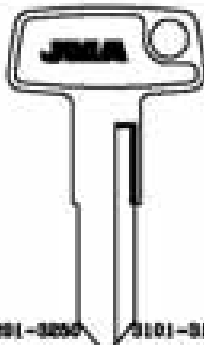

3201-3250
4201-4300
4301-4300
3701-3700
4181-4200
4751-4800
YAMA-14I
YAMA-14D

3401-3450
4001-4100
4501-4700
3301-3300
3951-4000
4551-4800
YAMA-15I
YAMA-15D

3201-3200
3401-3400
4401-4450
3101-3160
3301-3400
4301-4350
3601-3700
4201-4300
4801-4850
YAMA-12I
YAMA-12D
YAMA-16I
YAMA-16D

3201-3200
3601-3600
4401-4500
3151-3200
3751-3800
4351-4400
3801-3850
4001-4050
4601-4650
YAMA-13I
YAMA-13D
YAMA-17I
YAMA-17D
YAMA

I AL 4
32010-79897
A...
32010-79897
YAMA-18I
YAMA-18D
C...
32010-79897
YAMA-19I
YAMA-19D
E...
32010-79897
YAMA-20I
YAMA-20D
B...
32010-79897
YAMA-18I
YAMA-18D
D...
32010-79897
YAMA-19I
YAMA-19D
F...
32010-79897
YAMA-20I
YAMA-20D
MALAYSI-BELGIUM-YAMAHA

PARA:
FOR:

YAMAHA

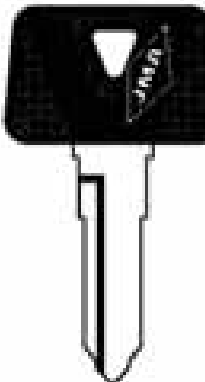
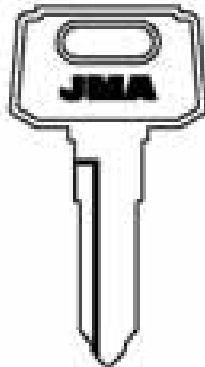
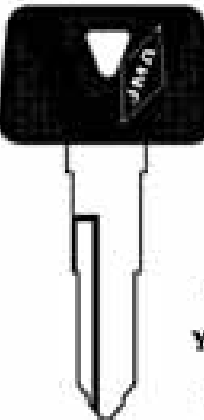

I AL 4
32010-79897
A...
32010-79897
YAMA-18I.P
YAMA-18D.P
C...
32010-79897
YAMA-19I.P
YAMA-19D.P
E...
32010-79897
YAMA-20I.P
YAMA-20D.P
MALAYSI-BELGIUM-YAMAHA

7001-8000
YAMA-21I
MEXICO-BELGIUM-YAMAHA

7001-7999
YAMA-21I.P
MEXICO-BELGIUM-YAMAHA

Copyright by
Algebra Almas S.A.
2018

JMA



219

PARA:
FOR:

ZADI

PARA-FOR:

ZADI (I)

ZIL (RUS)

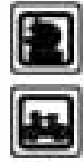

8001-8004
ZL
ZA-3D

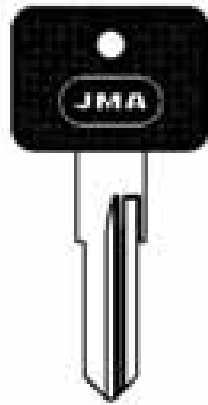

ZL
ZA-5.P

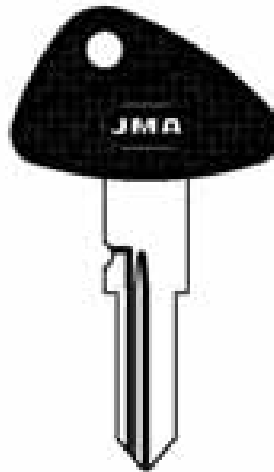

8001-8004
ZL
ZA-6D.P
BYE



8001-8004
ZL
ZA-6D.P1
APRILIA-8076

PARA:
FOR:

ZADI

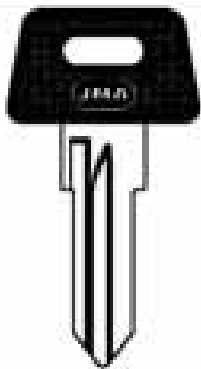

8001-8004
ZL
ZA-7D.P
MAGGI-76600

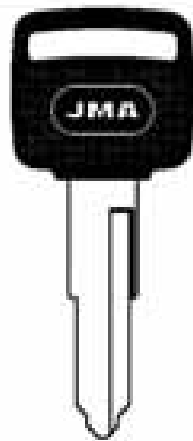

ZL
ZA-8.P

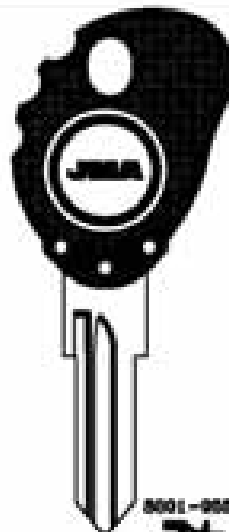

8001-8004
ZL
ZA-9.P
MAGGI-766

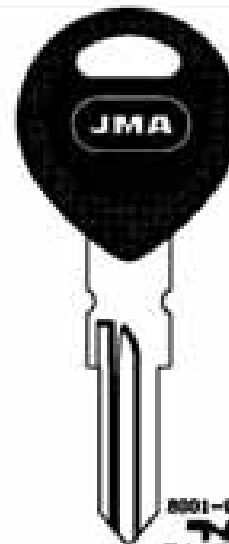

8001-8004
ZL
ZA-9.P1
MAGGI-800-TABARA

PARA:
FOR:

ZADI

ZIL

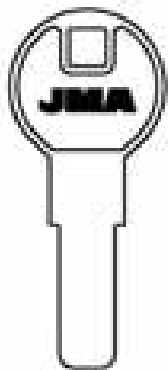

ZL
ZA-10

LAT.

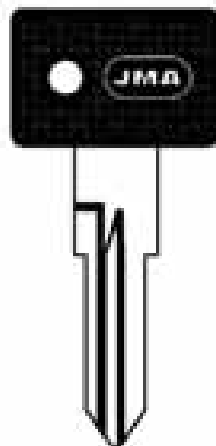

8001-8476
ZL
ZA-13.P

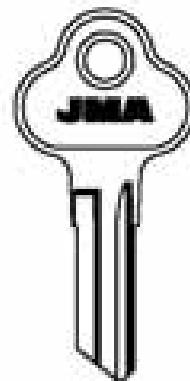

ZL
ZI-1

Copyright by
Alejandro Altamir S.A.
2018

JMA



221

LLAVES DE CIERRE

IXTEKO GILTZAK

SNAP-LOCK KEYS

CLÉS DE BOUCHE D'EAU

DORNSCHLÜSSEL



THE KEY TO EXCELLENCE
GLOBALLY UNLOCKING MILLIONS OF DOORS DAILY

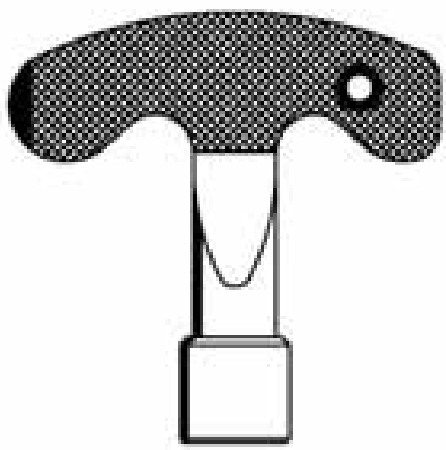

ZAM.

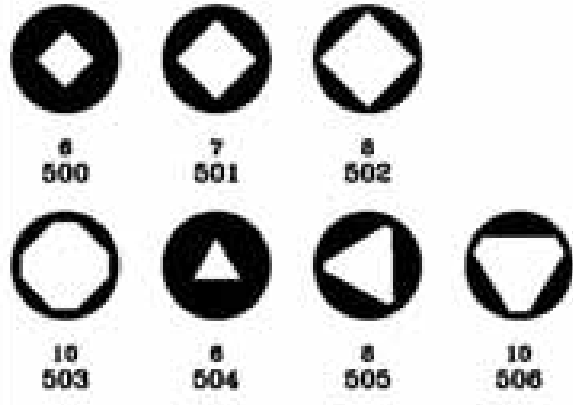

6 500 7 501 8 502

10 503 8 504 8 505 10 506

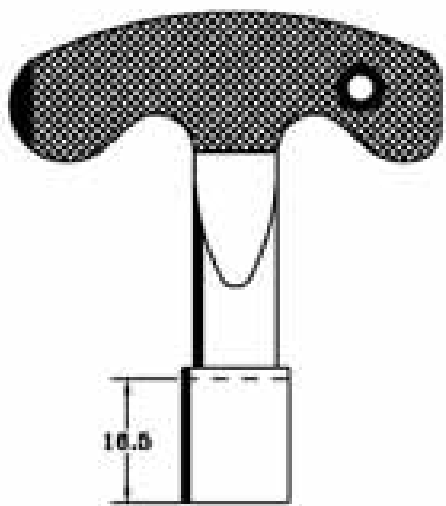

ZAM.

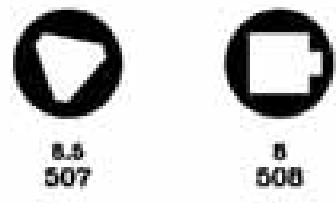

8.5 507 8 508

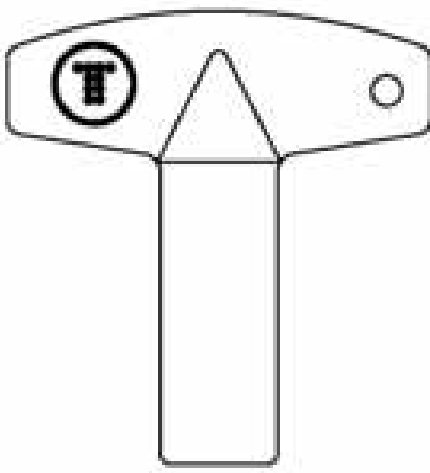

PLAS.



8.5 509

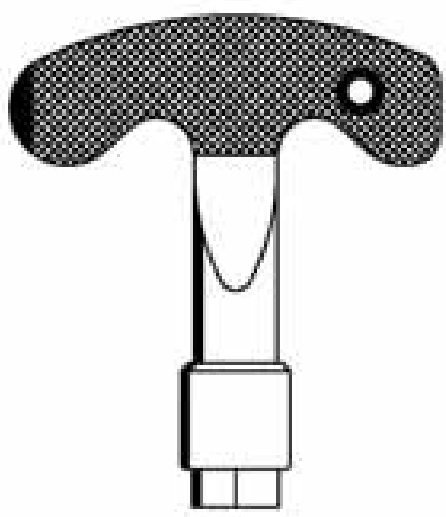

ZAM.



8 510

Copyright by
Aluminio Almas S.A.
2018

JMA



223

PARA-FOR:

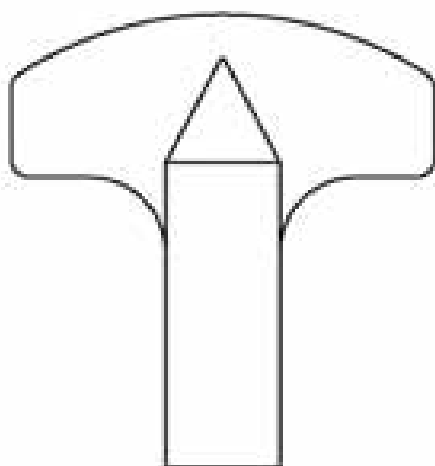

ALU.



8.5
511

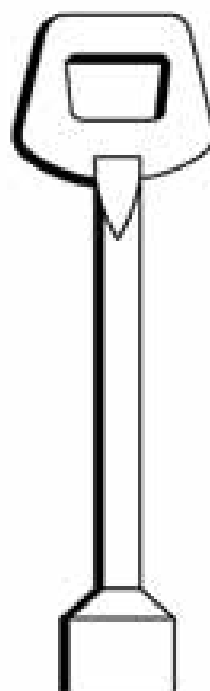

ZAM.



10
512

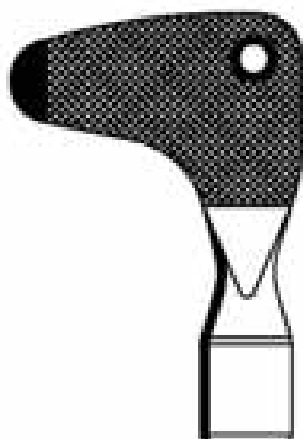

LAT.



8.5
513
ORONA

Copyright by
Alejandro Allina S.A.
2018

JMA

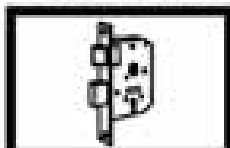

224

LLAVES EN CRUZ





*GURUTZE-GILTZAK
CRUCIFORM KEYS
CLÉS CRUCIFORMES
KREUTZSCHLÜSSEL*





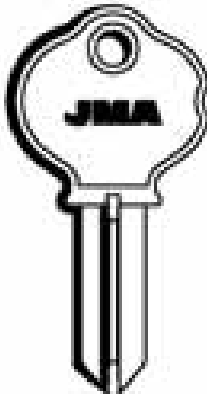
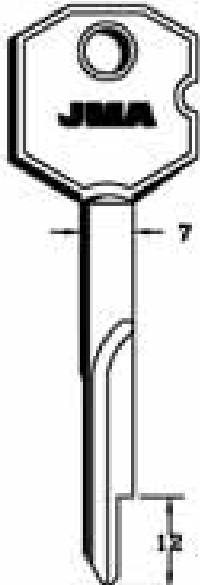
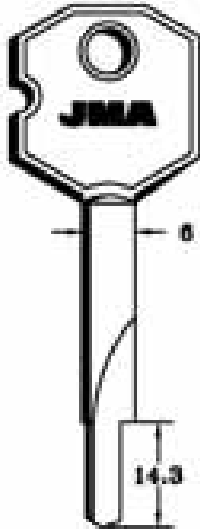

THE KEY TO EXCELLENCE
GLOBALLY UNLOCKING MILLIONS OF DOORS DAILY

PARA-FOR:

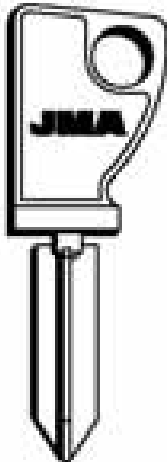
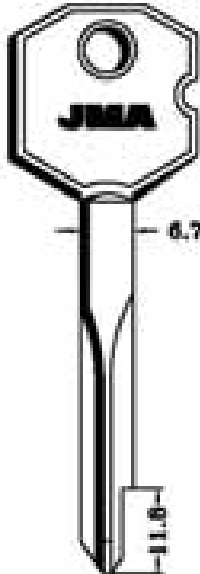
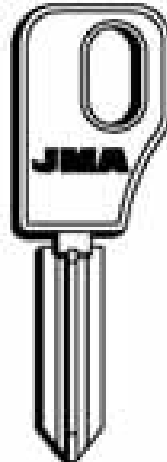
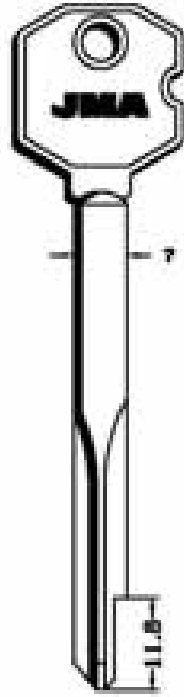
- AGC (F)
- ALA (I)
- BLUMA (D)
- BRICARD (F)
- BURG (D)

PARA-FOR:	AGC	ALA	BLUMA
			
	 <p>AGD-1X CCPS</p>	 <p>ALA-1X</p>	 <p>BLU-1X</p>

PARA-FOR:	BRICARD	BURG
		
		
	 <p>BRI-1X</p>  <p>BRI-2X</p>	 <p>BUR-1X 75mm THOVING</p>  <p>BUR-2X 90mm TETA</p>

Copyright by
Alejandro Allina S.A.
2018

JMA



226

PARA:
FOR:

BURG

CCF

PARA-FOR:

BURG (D)

CCF (P)

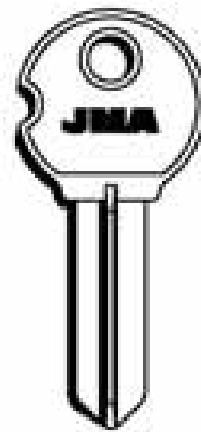
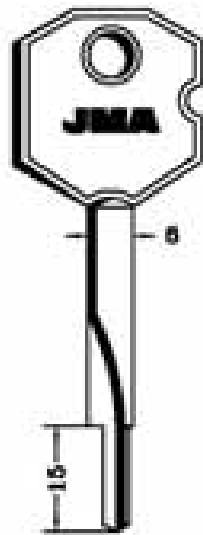
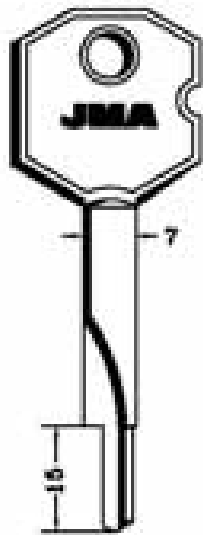
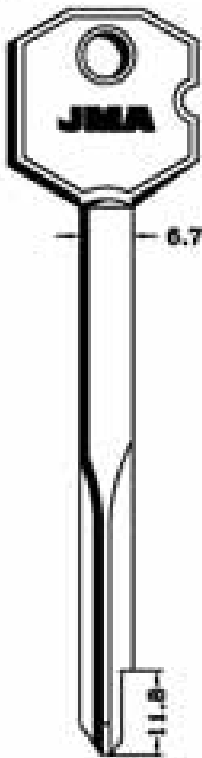

PARA:
FOR:

CCF

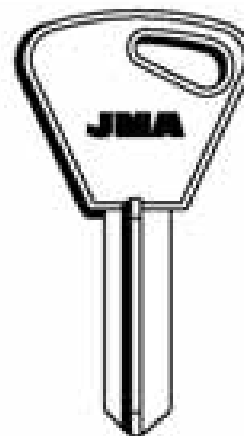
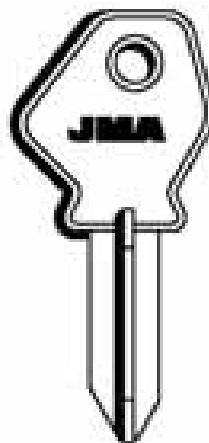
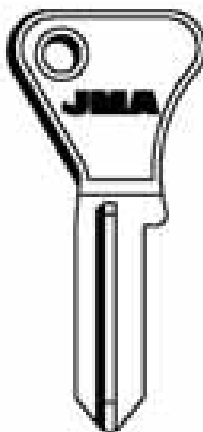
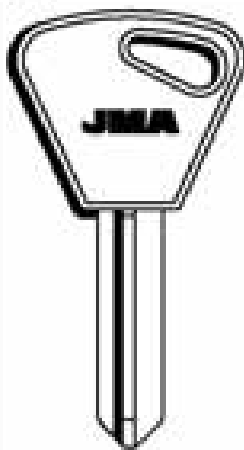

Copyright by
Alejandro Altman S.A.
2018





JMA





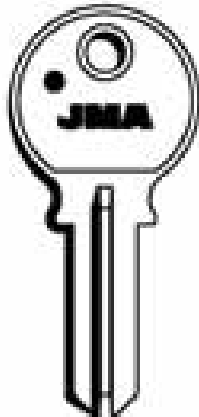
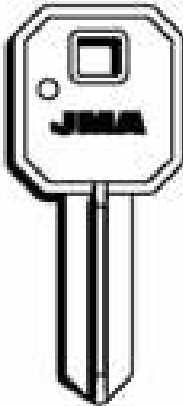
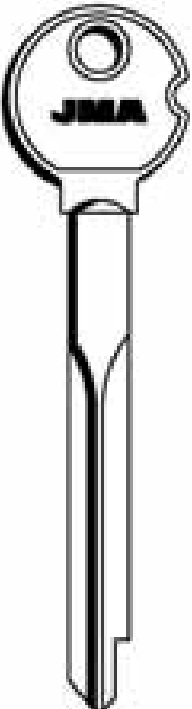
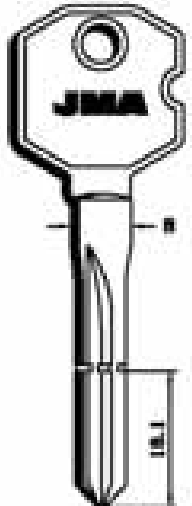

227

PARA-FOR:

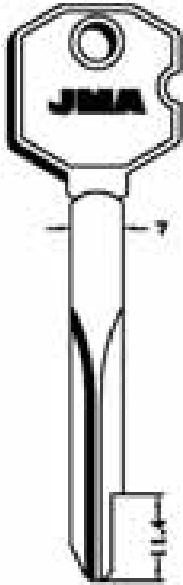
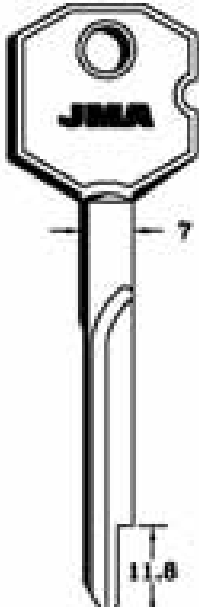
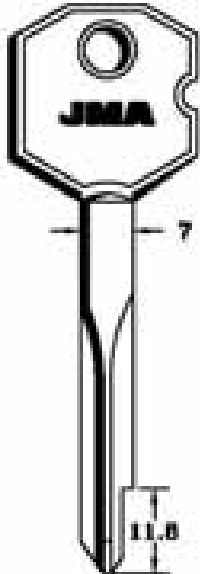
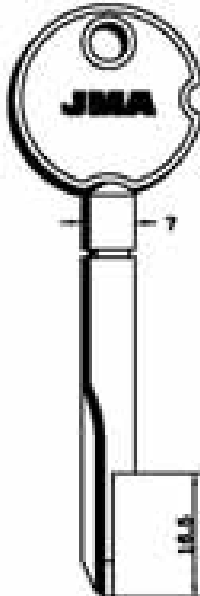
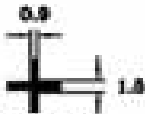
- CIFIAL (F)**
- CRC CAMBOA (F)**
- DEBEAURAIN (F)**
- DOOR LOCK**
- FAYN (TR)**
- FIAM (D)**
- FRIPA (D)**

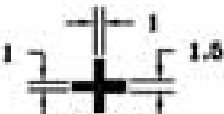
PARA-FOR:	CIFIAL	CRC CAMBOA	DEBEAURAIN	DOOR LOCK
				
	 CIF-1X CFM	 CRC-1X	 DEB-1X	 DOL-1X









PARA-FOR:	FAYN	FIAM		FRIPA
				
	 FAY-1X	 FIAM-1X	 FIAM-2X	 FRI-1X CERA

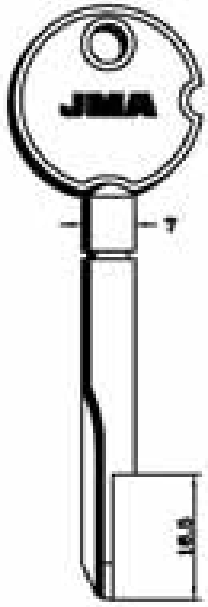



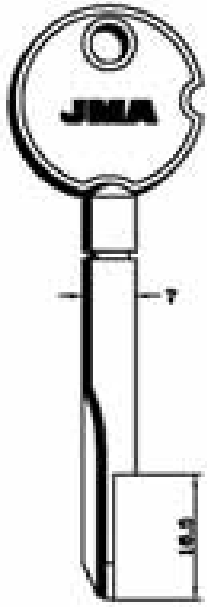

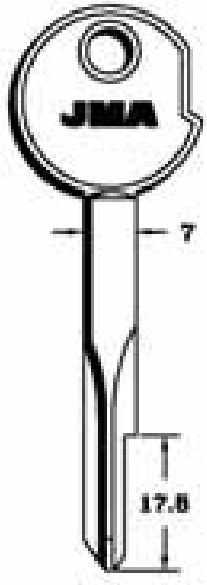

Copyright by
Algodoro Altimus S.A.
2018

JMA

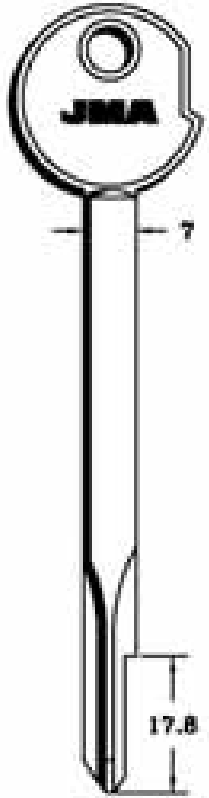

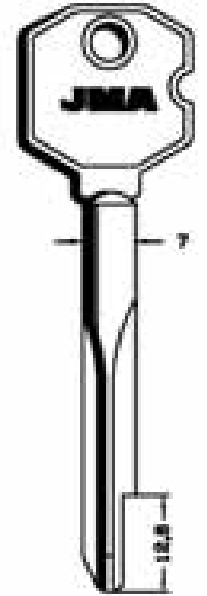

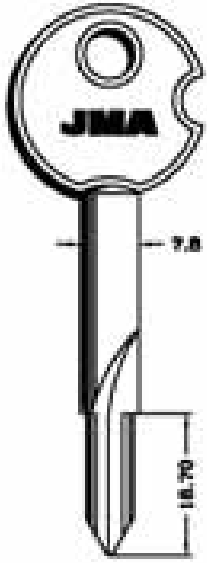
228

PARA-FOR: FRIPA	GERA		HELCO KJV	PARA-FOR:
  <p>FRI-2X GEM</p>	  <p>GEA-1X</p>	  <p>GEA-3X</p>	  <p>KJV-1X 70mm</p>	<p>FRIPA (D) GERA (D) HELCO KJV (D) ISEO (I) KRESTI (RUS)</p>

PARA-FOR: HELCO KJV	ISEO	KRESTI	
  <p>KJV-2X 80mm</p>	  <p>KJV-3X 100mm</p>	  <p>IS-1X</p>	  <p>KR-1X</p>

Copyright by
Aljeandro Altman S.A.
2018

229

PARA-FOR:

PARA-FOR:

KRESTI

KRESTI (RUS)

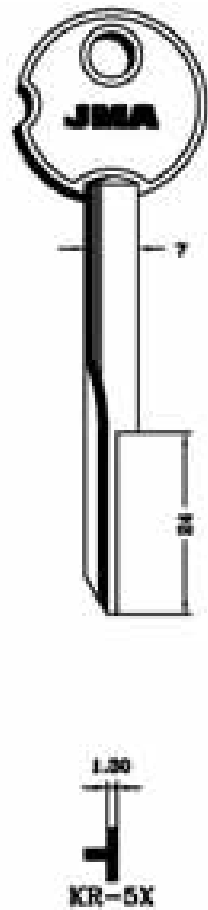
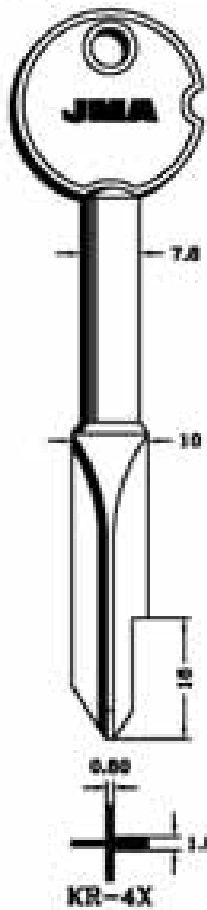
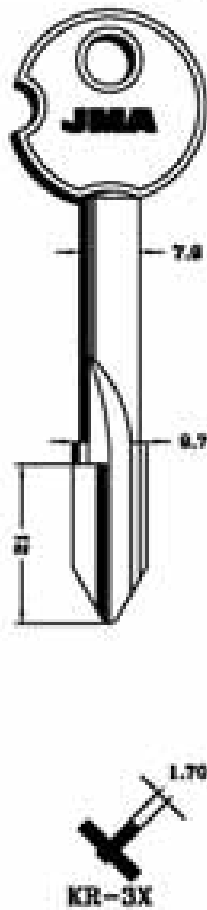
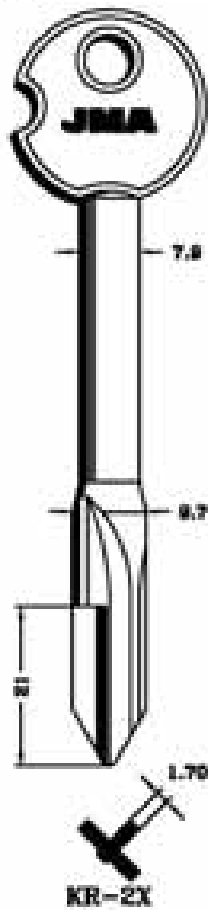

PARA-FOR:

KRESTI

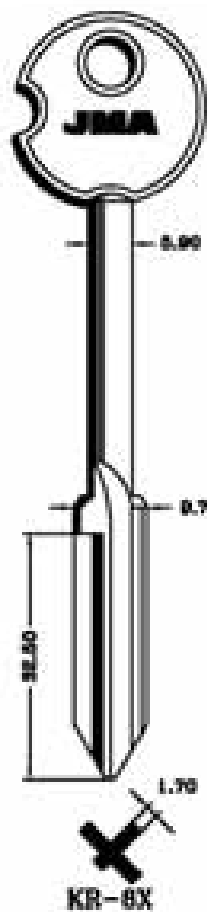
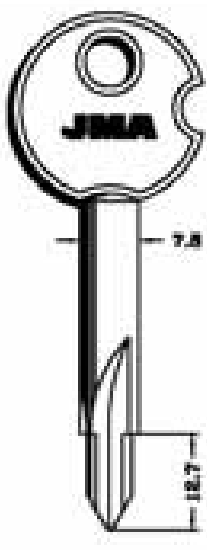
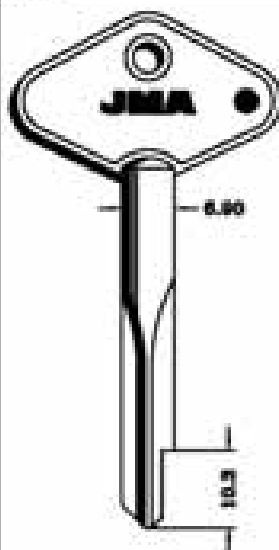

Copyright by
Alejandro Allina S.A.
2019

JMA



230

PARA:
FOR:

KRESTI

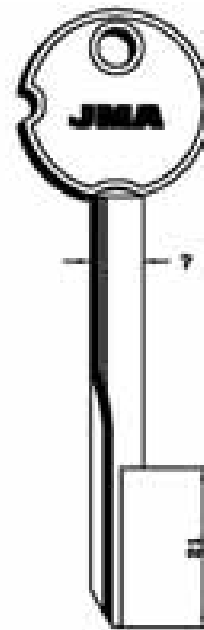
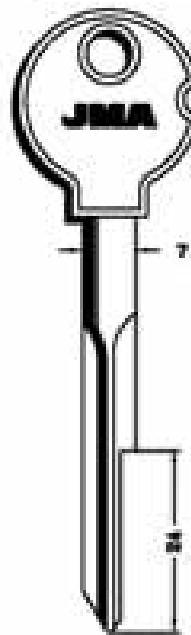
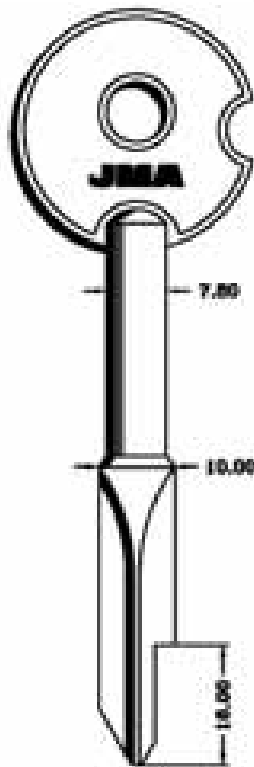
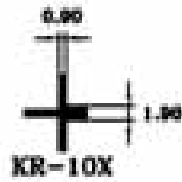
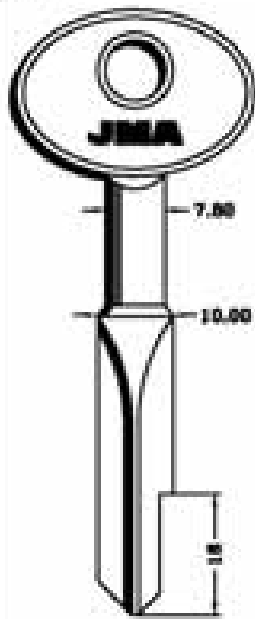

PARA-FOR:

KRESTI (RUS)

PARA:
FOR:

KRESTI

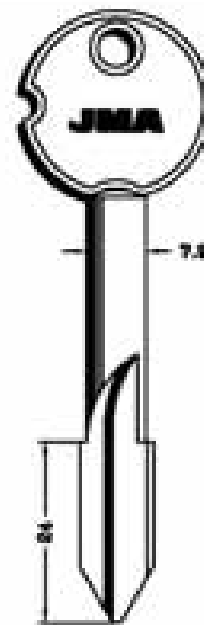
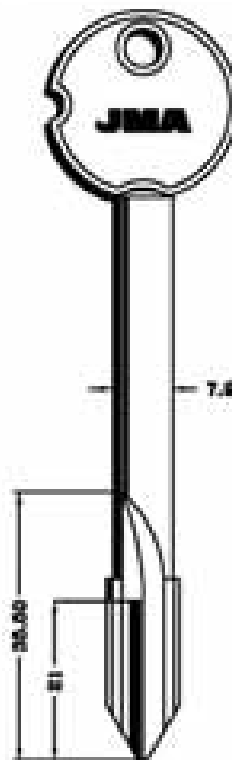
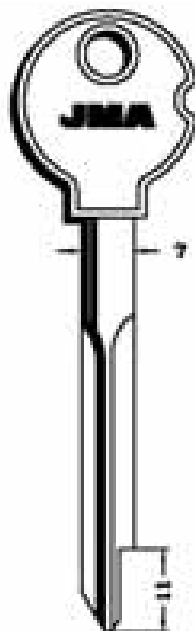
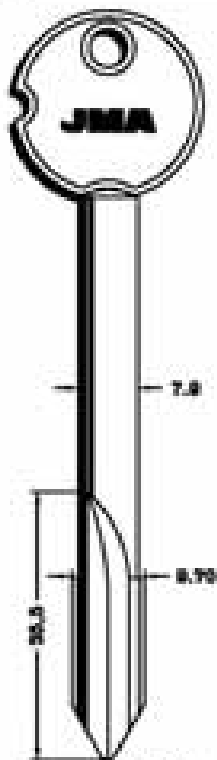

Copyright by
Alejandro Altman S.A.
2018

JMA



231

PARA-FOR:

LOCK-IT (GB)

MAFOR (F)











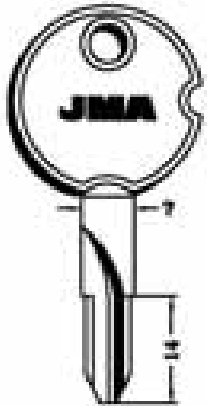

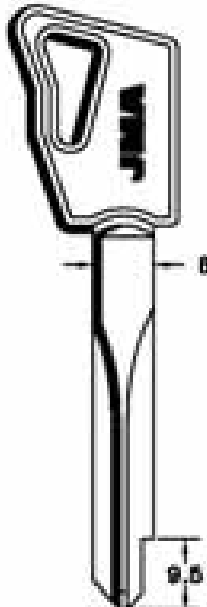

MINI MOLA (P)

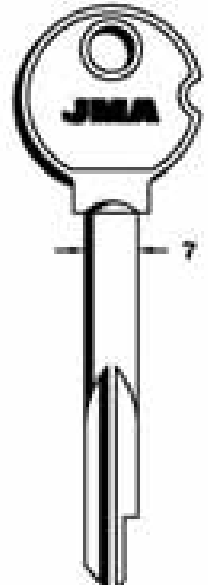
MOREAUX (F)

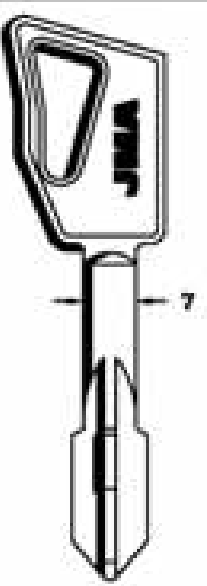
MSV (P)

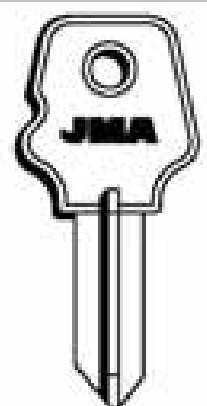
NABOB (IL)

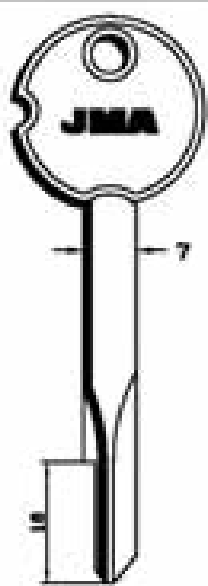
NEMEF (D)

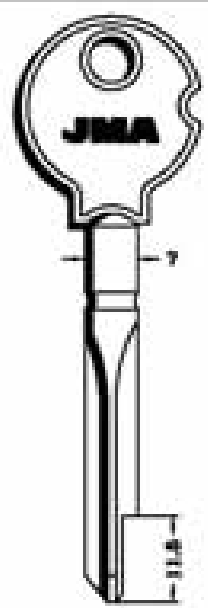
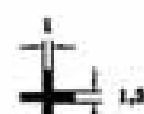
PARA-FOR:	LOCK-IT	MAFOR	MINI MOLA	MOREAUX
	  <p>LCK-1X</p>	  <p>RO-1X BOND-BOB</p>	  <p>MM-1X CCFF ANA</p>	  <p>MOR-1X</p>
PARA-FOR:	MOREAUX	MSV	NABOB	NEMEF
	  <p>MOR-2X</p>	  <p>MSV-1X</p>	  <p>NAB-1X</p>	  <p>NEF-1X</p>

Copyright by
Algebra Altesa S.A.
2008

JMA

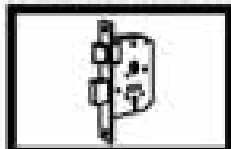

232

PARA:
FOR:

PAPAIZ

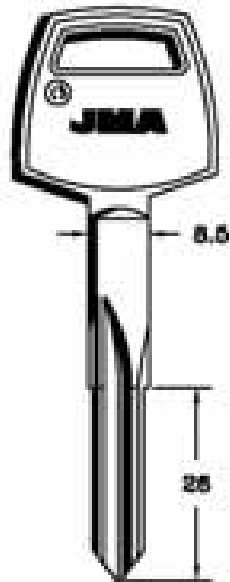
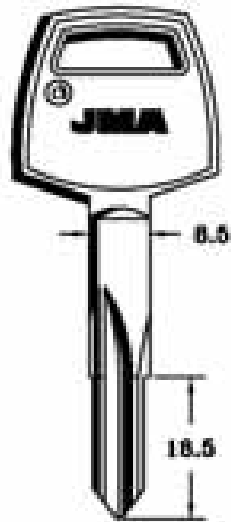

TUFF

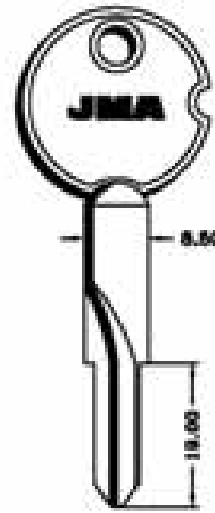
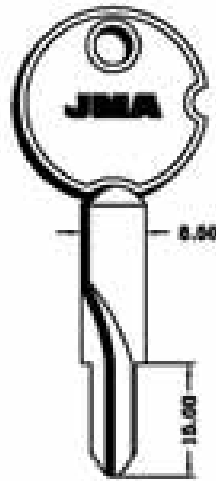

PARA-FOR:

**PAPAIZ (BR)
TUFF (HK)
UNIVERSAL
YALE BKS
(I) (D)**

PARA:
FOR:

TUFF

UNIVERSAL

YALE BKS

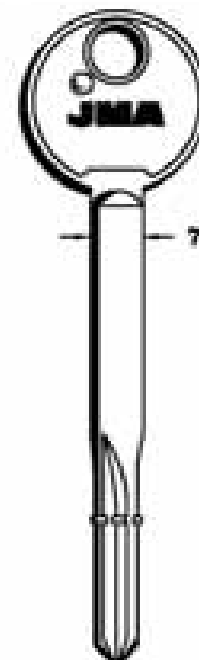
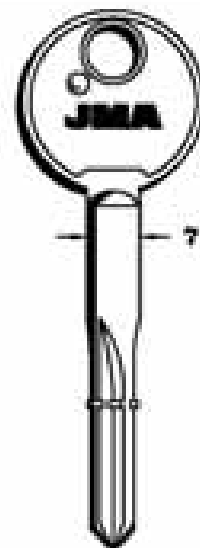
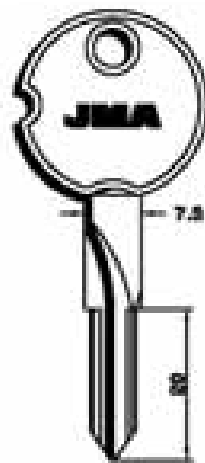
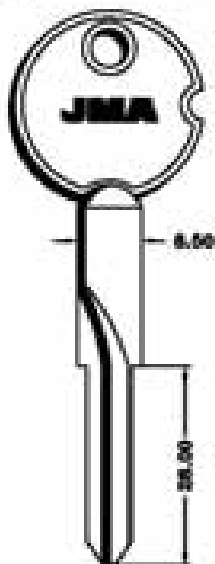

Copyright by
Aljeandro Altman S.A.
2018

JMA



233

PARA-FOR:

PARA FOR: YALE BKS

**YALE BKS
(D) (D)**

YALE (D)

**ZEISS IKON
(D)**

YALE

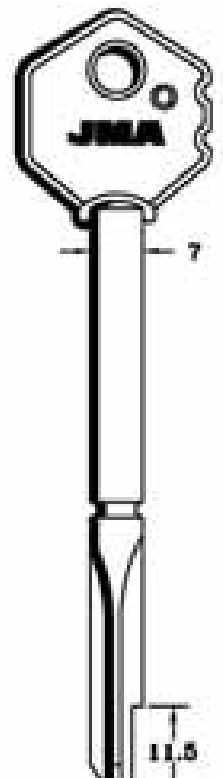
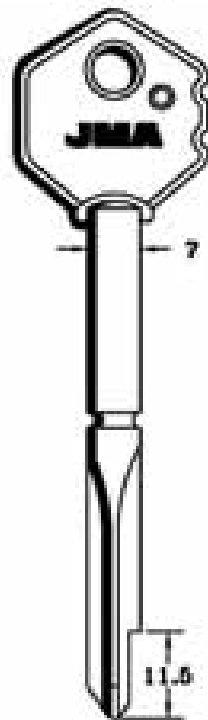
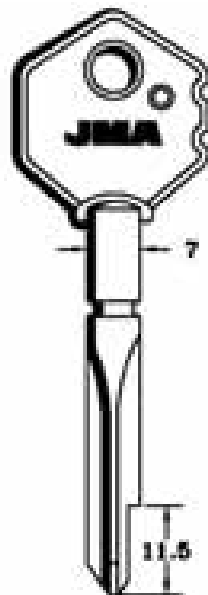
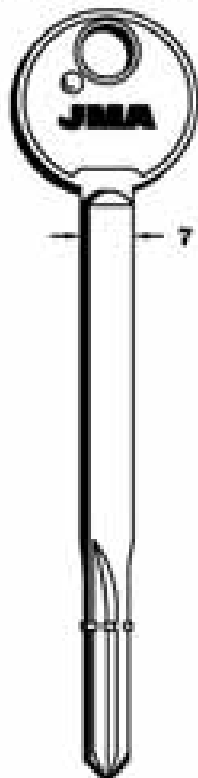

PARA FOR:

ZEISS IKON

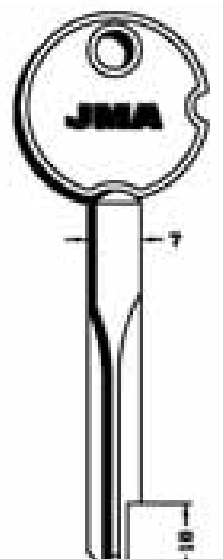
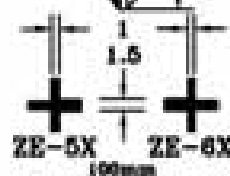
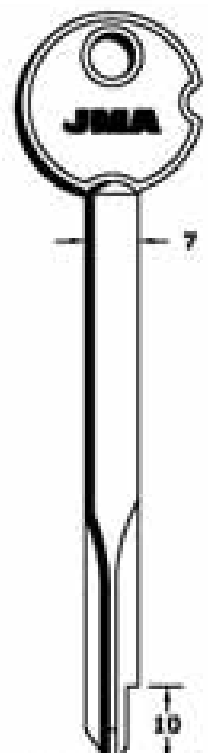
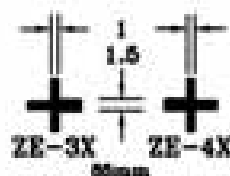
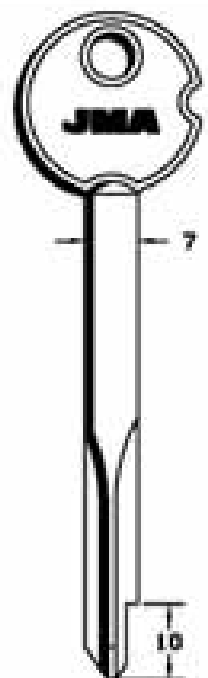
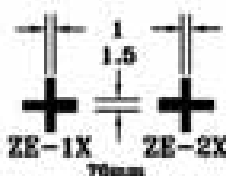
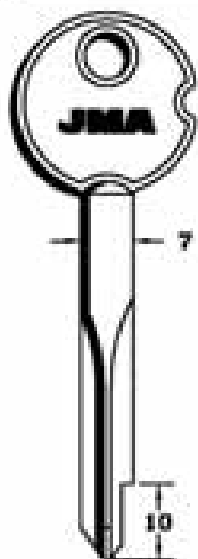

Copyright by
Alejandro Altamir S.A.
2018

JMA



234

PARA:
FOR:

ZEISS IKON

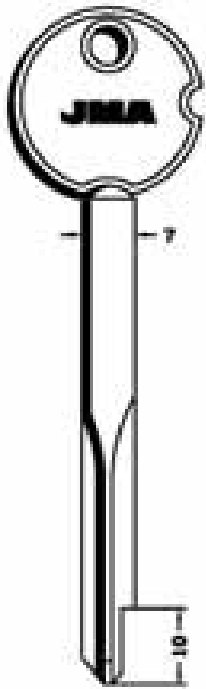

←
ZE-8X
90mm

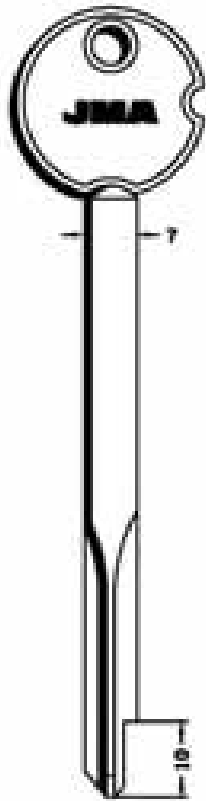

←
ZE-9X
100mm

PARA-FOR:

**ZEISS IKON
(D)**

Copyright by
Alejandro Altamir S.A.
2018

JMA



235

LLAVES DE GORJA ACERO DULCE

ALTZAIRU GOZOZKO GORJA-GILTZA

MILD STEEL BIT KEYS

CLÉS À GORGES EN ACIER DOUX

CHUBBSCHLÜSSEL AUS WEICHSTAHL



THE KEY TO EXCELLENCE
GLOBALLY UNLOCKING MILLIONS OF DOORS DAILY

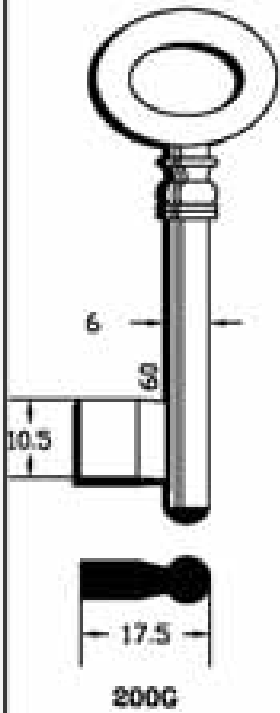

200G

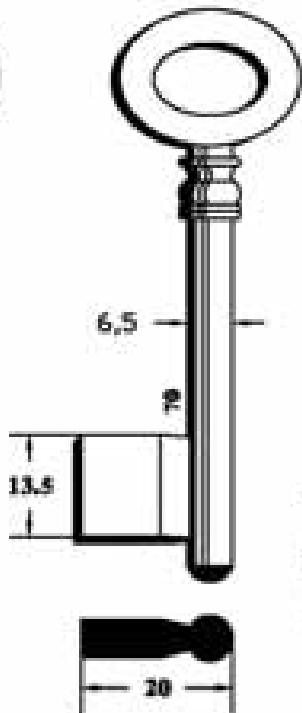

201G

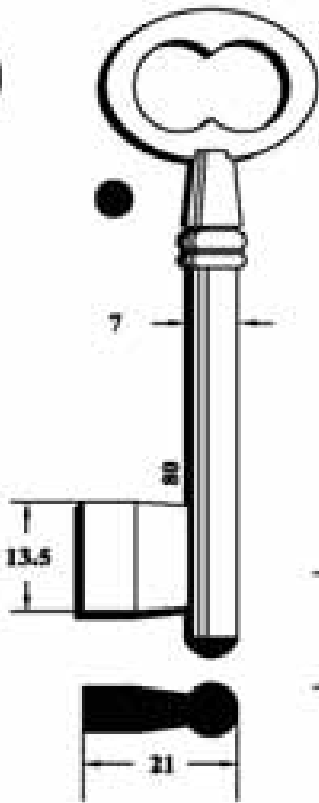

202G

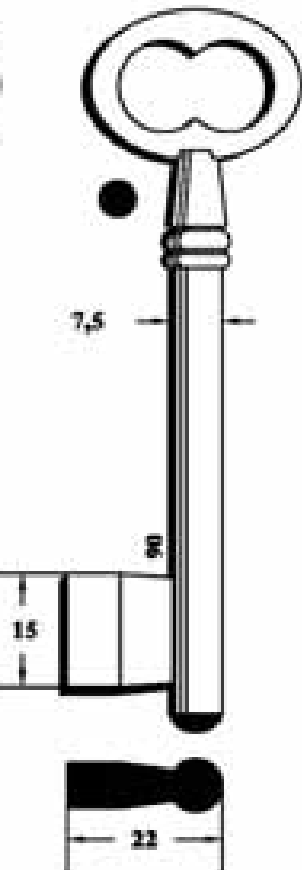

203G

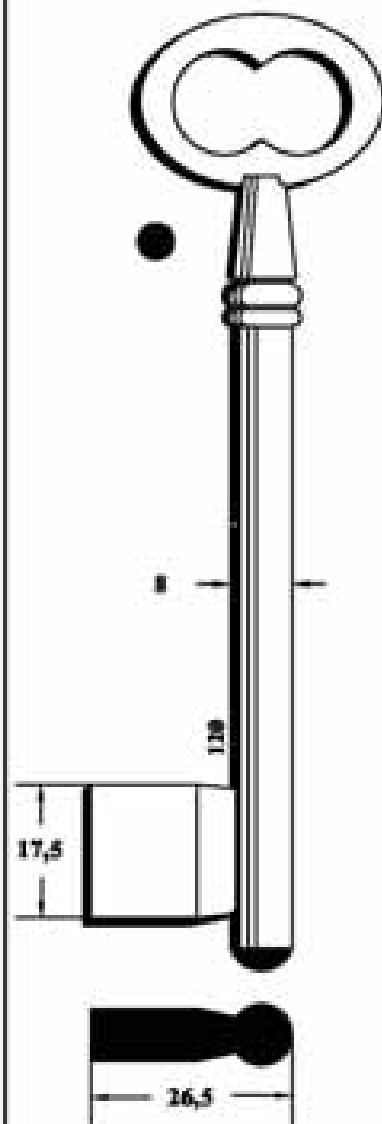

206G

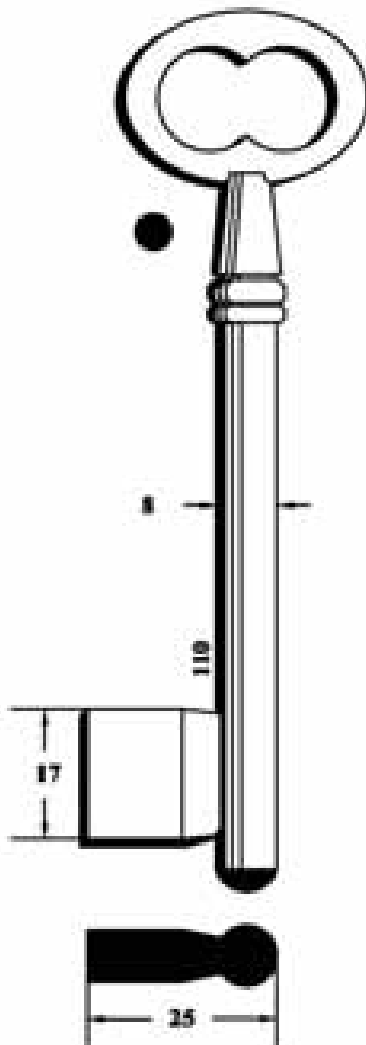

205G

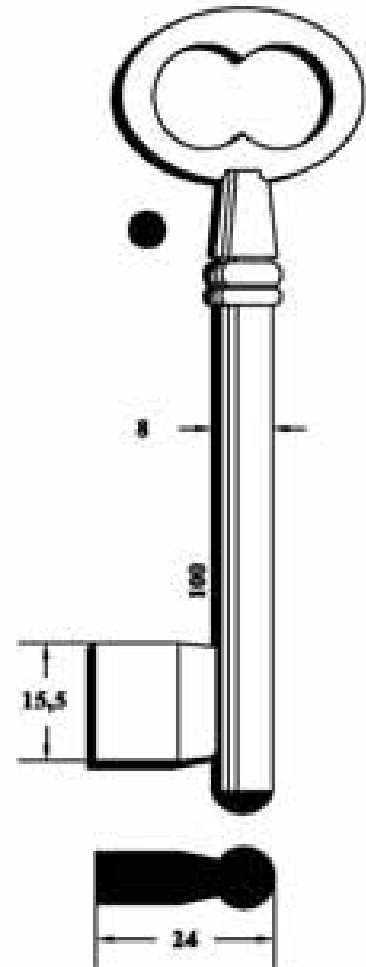

204G

Copyright by
Alejandro Altman S.A.
2018

JMA



237

PARA-FOR:

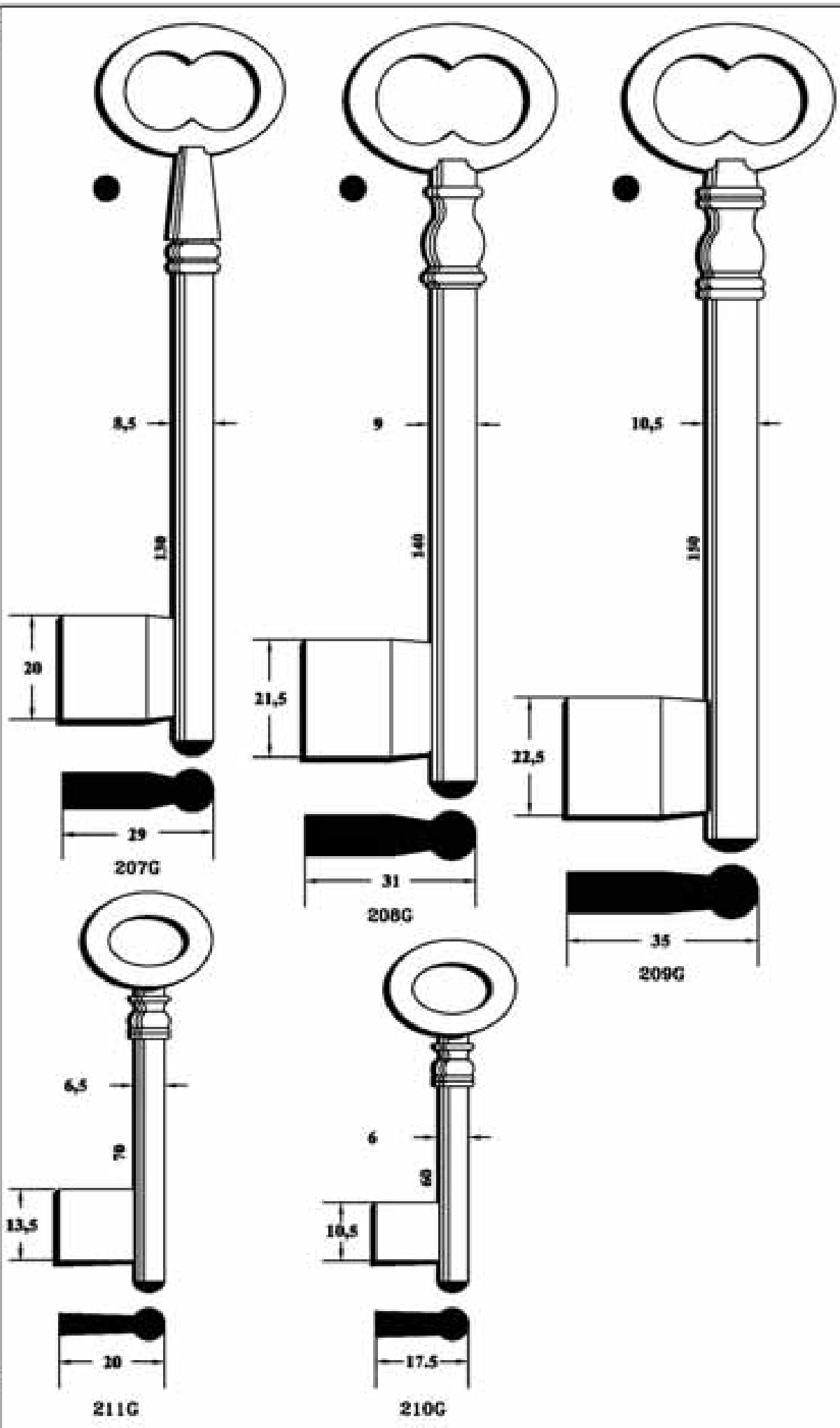

Copyright by
Alejandro Allina S.A.
2018

JMA

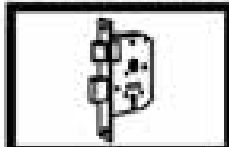

238

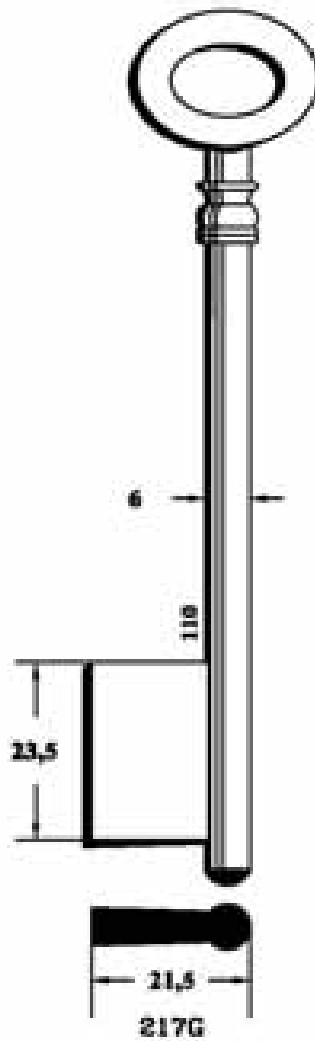
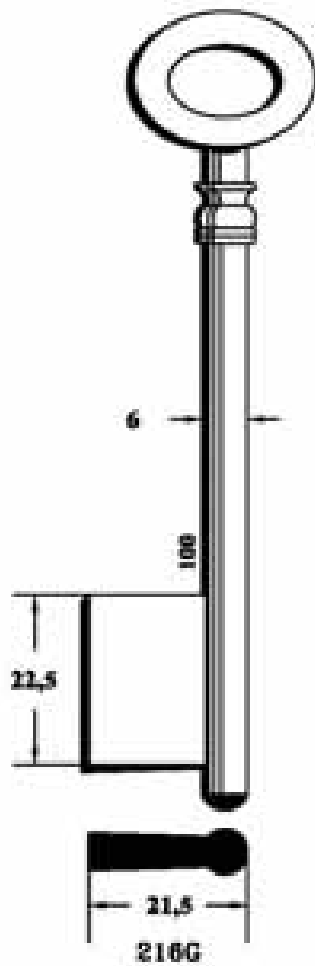
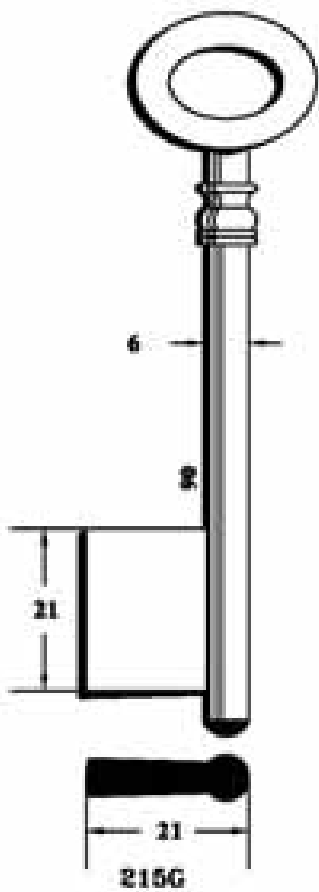
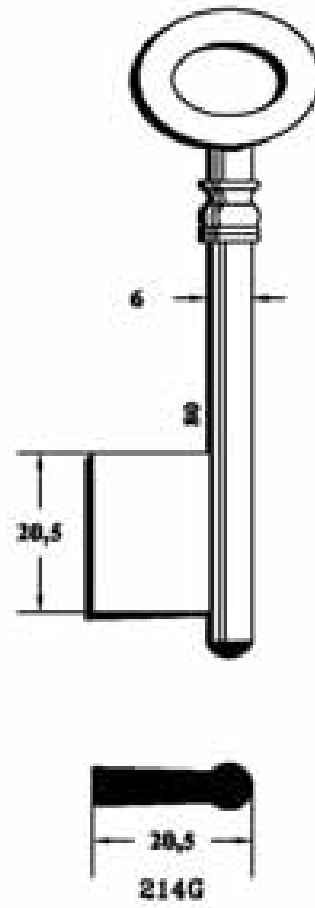
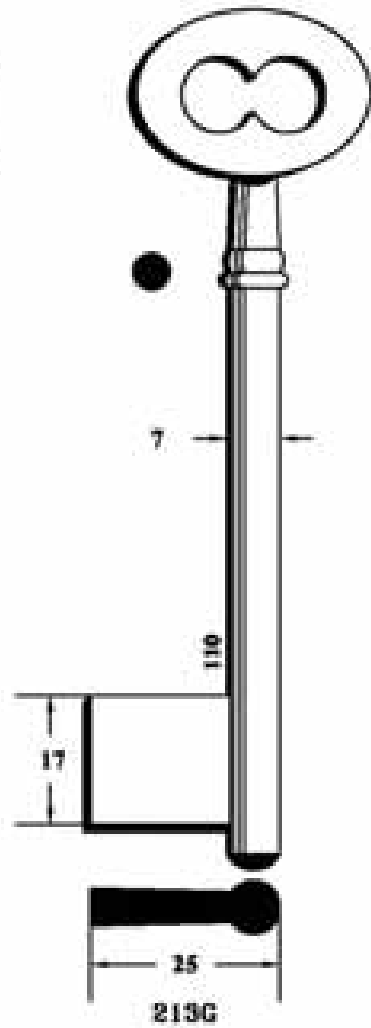
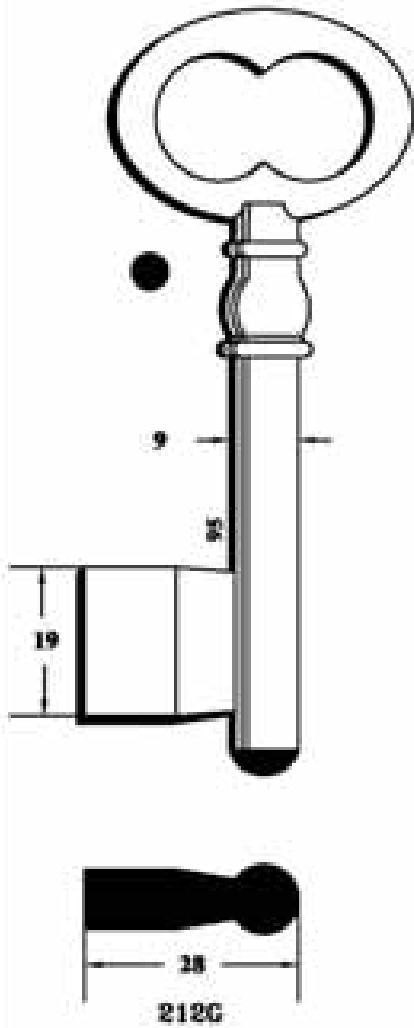

Copyright by
Almagro Almagro S.A.
2018

JMA



239

PARA-FOR:

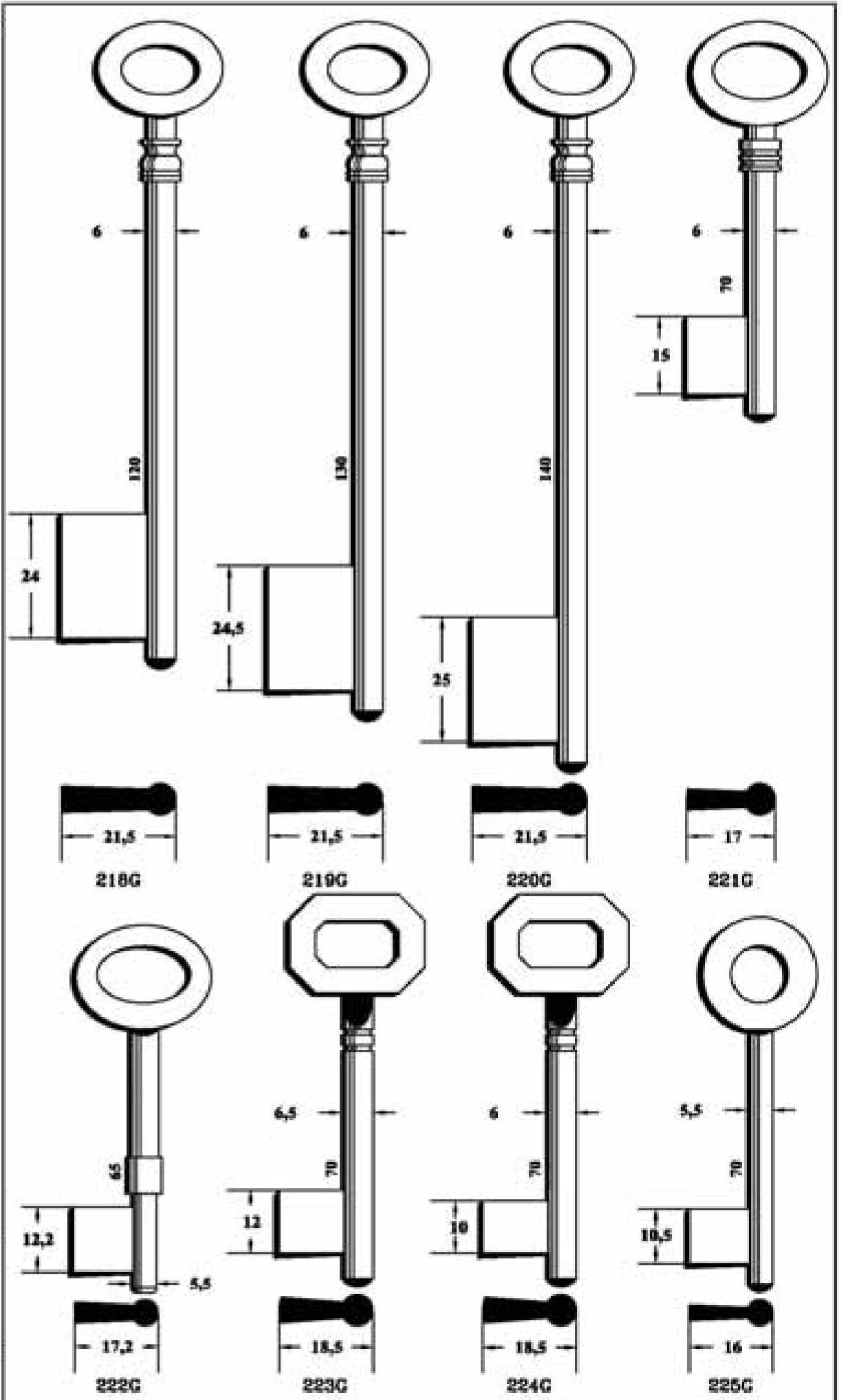

Copyright by
Alejandro Allina S.A.
2018

JMA

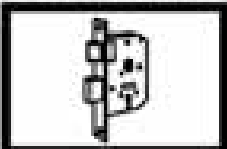

240

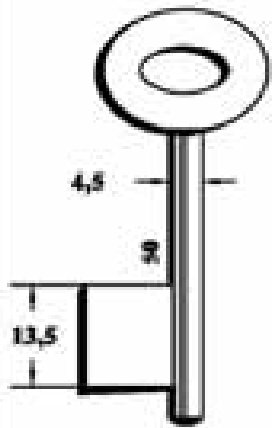

226G

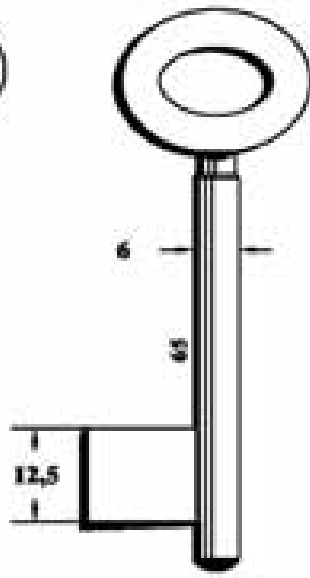

227G

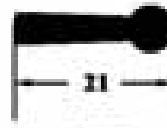
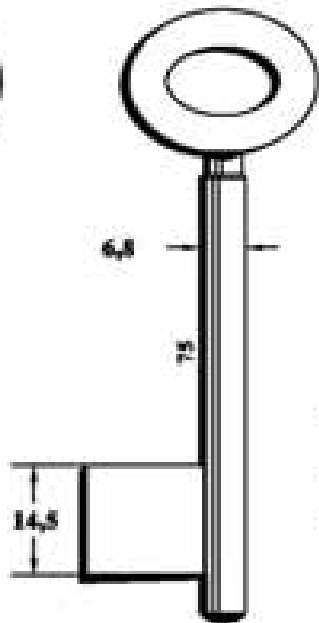

228G

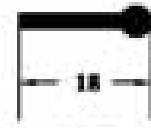
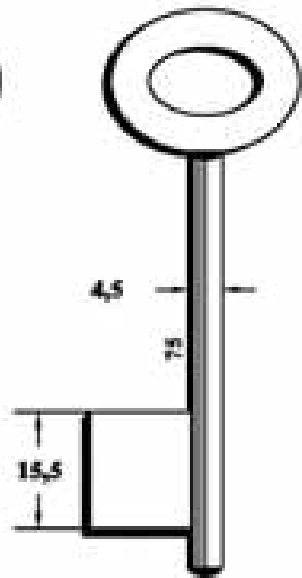

229G

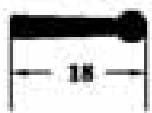
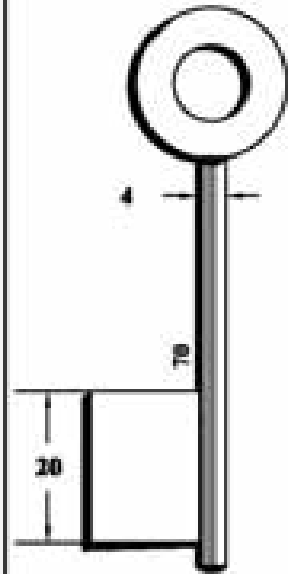

230G

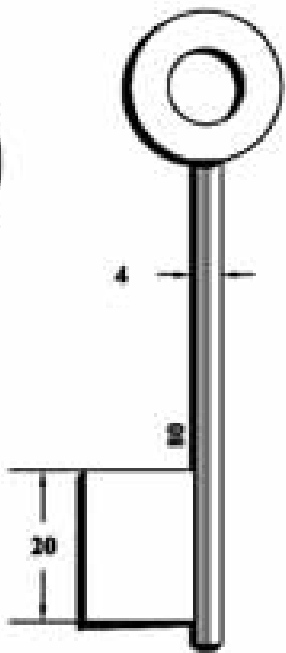

231G

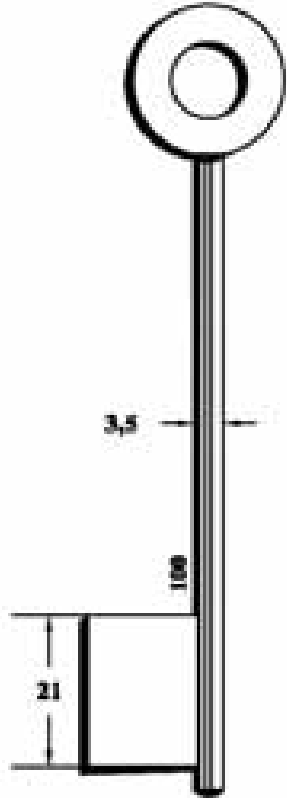

232G

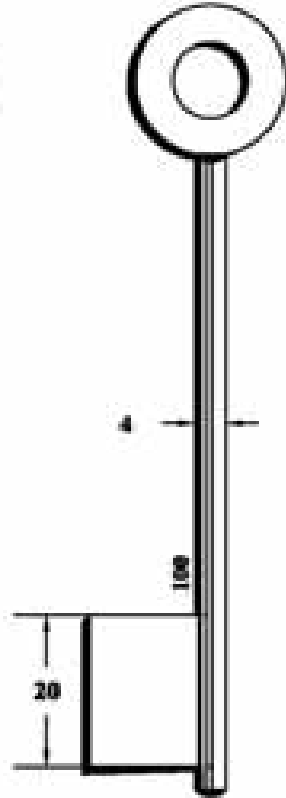

233G

Copyright by
Aljeandro Almon S.A.
2018

JMA



241

PARA-FOR:

BOINATTI (I)

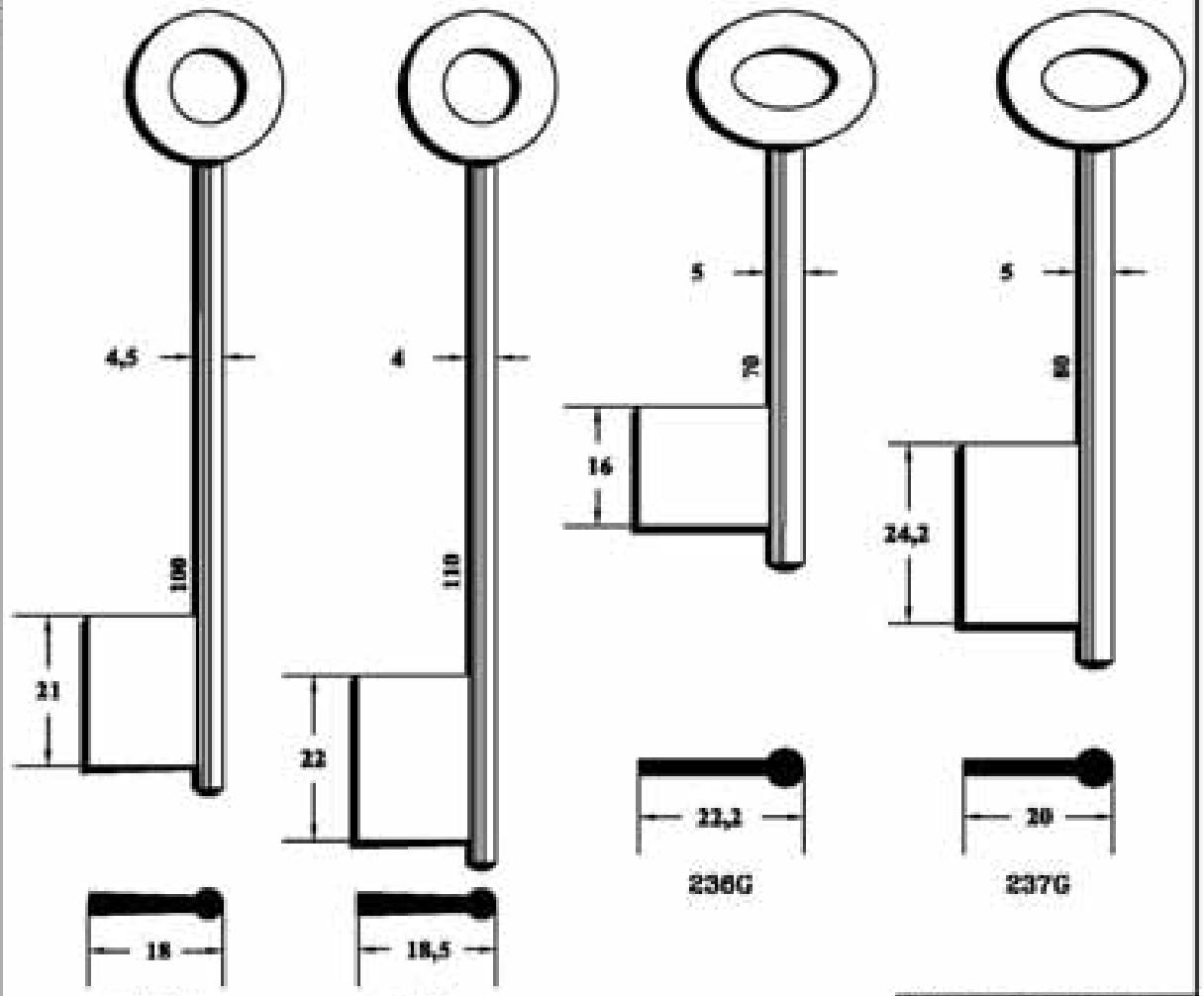

234G

235G

236G

237G

PARA-FOR: BOINATTI

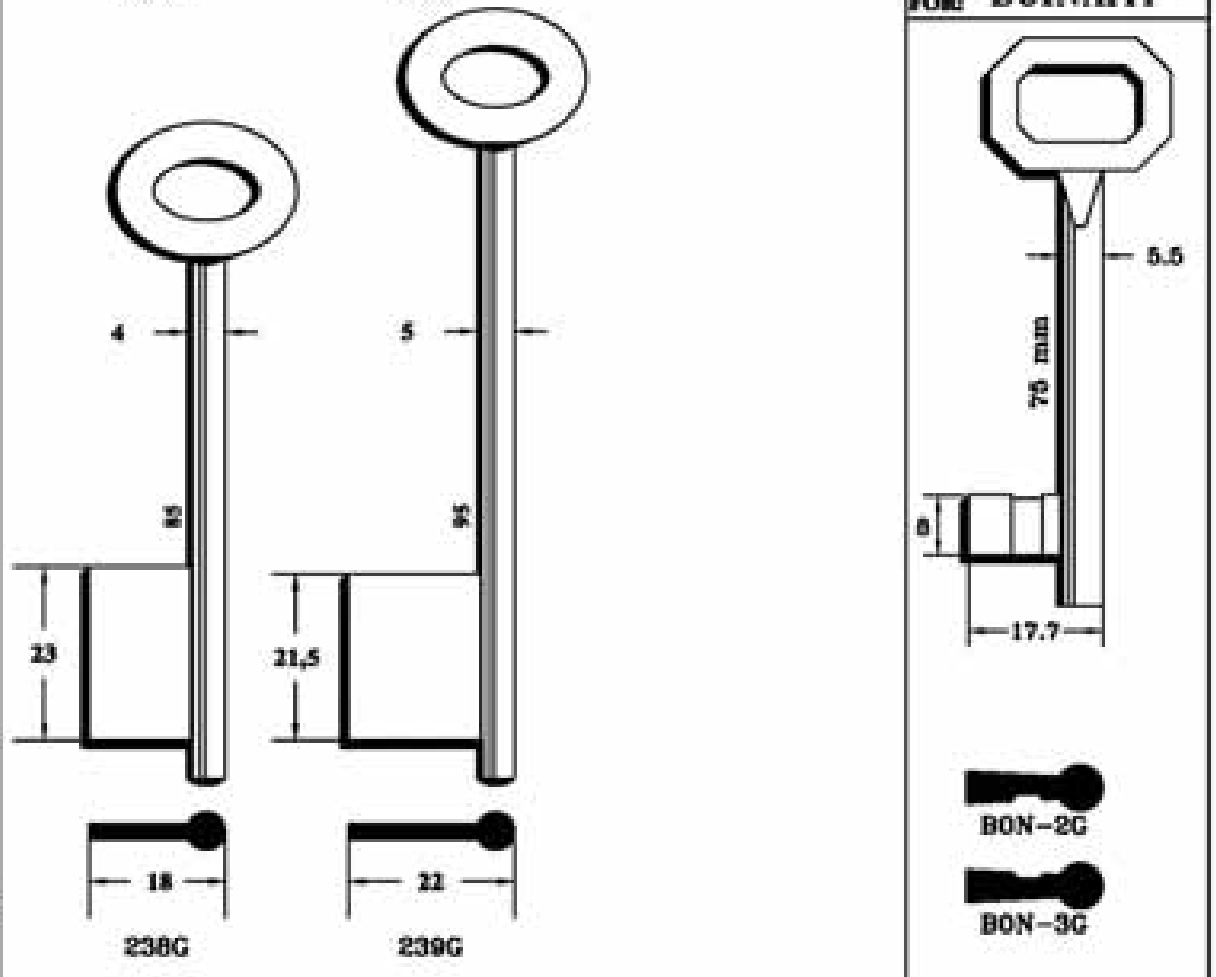

238G

239G

BON-2G

BON-3G

Copyright by
Alejandro Allina S.A.
2010

JMA



242

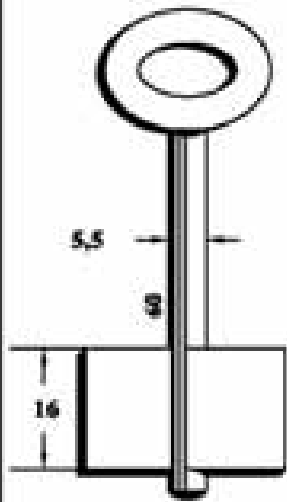

600G

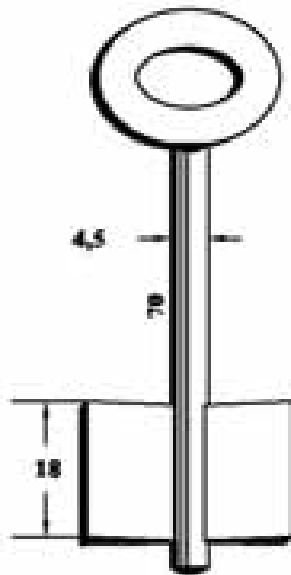

601G

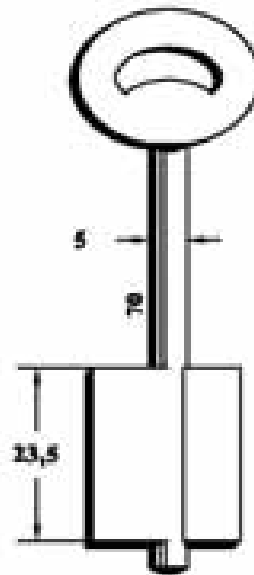

602G

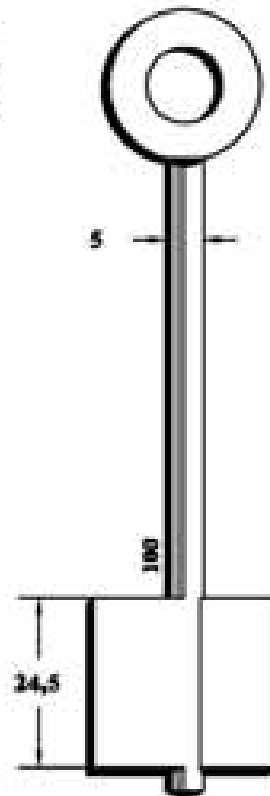

603G

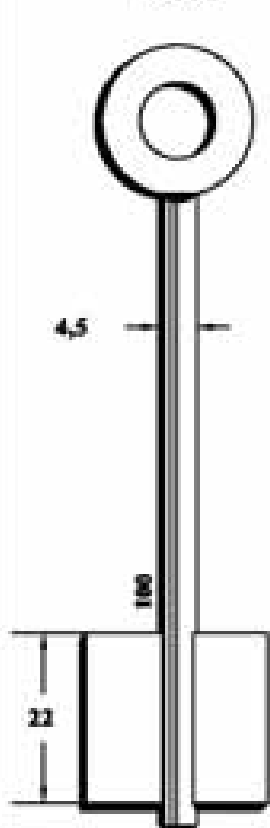
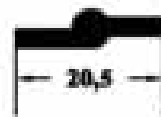

604G

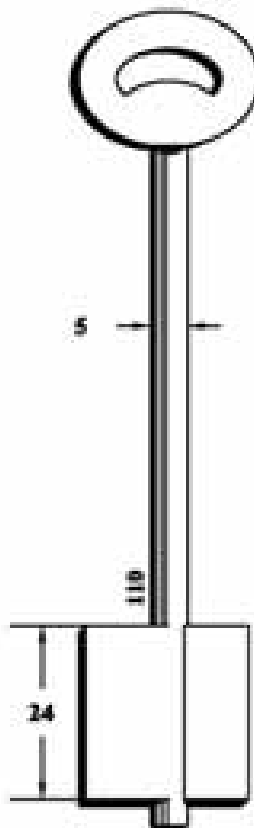

605G

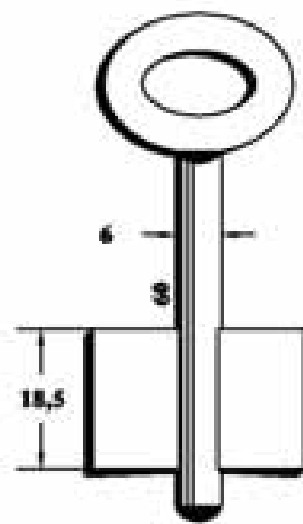

606G

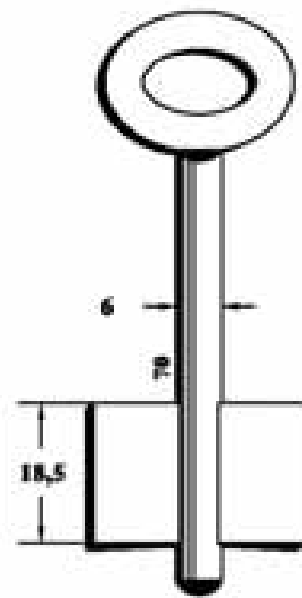

607G



Copyright by
Aljeandro Almon S.A.
2010

JMA



243

PARA-FOR:

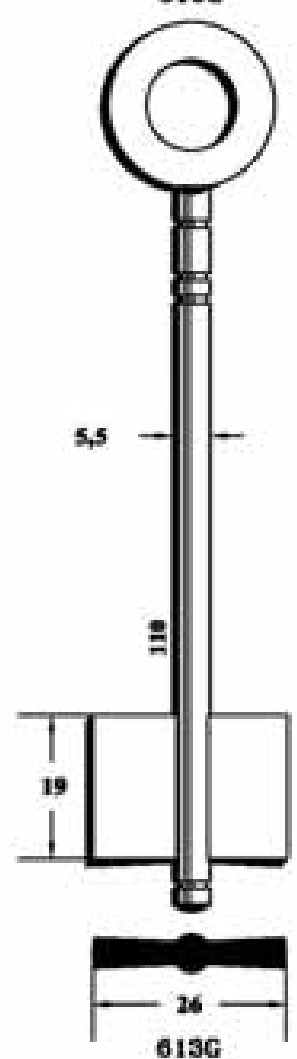
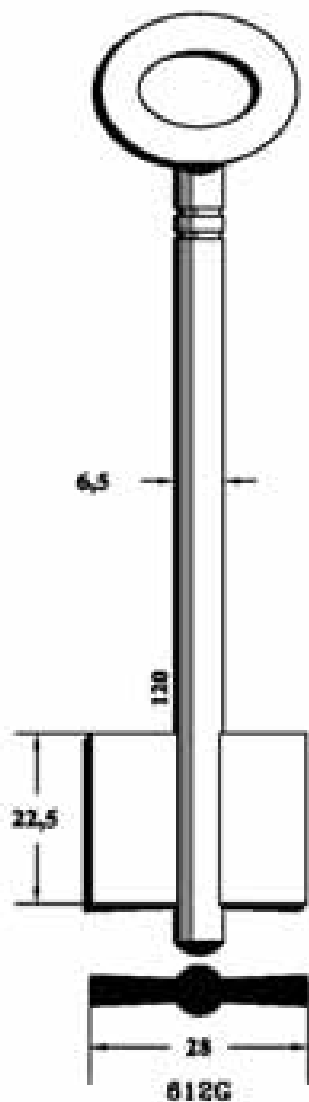
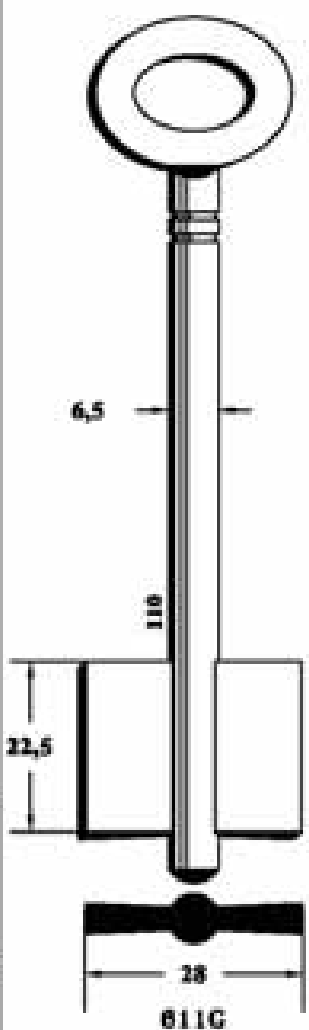
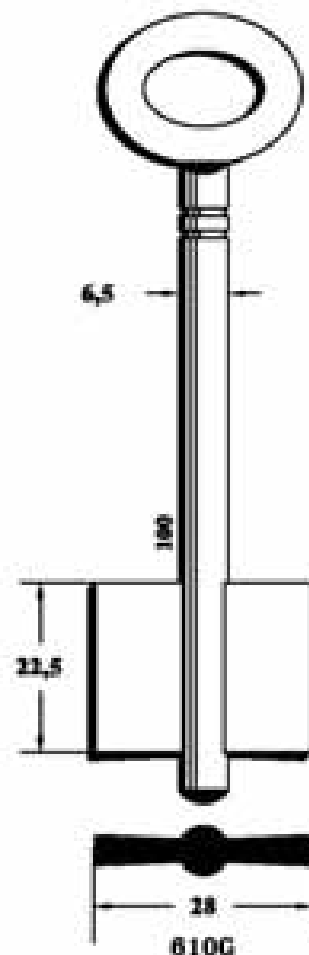
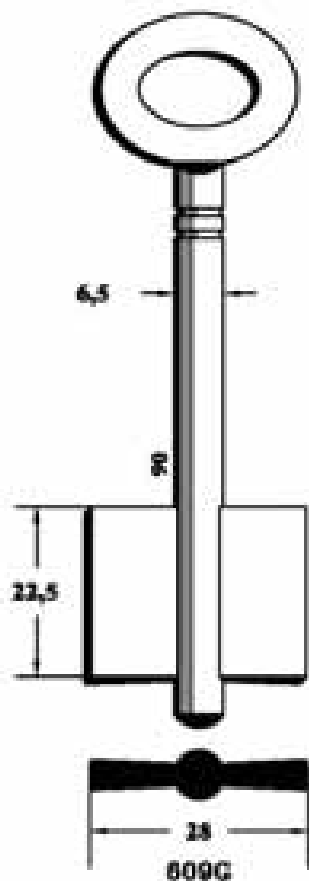
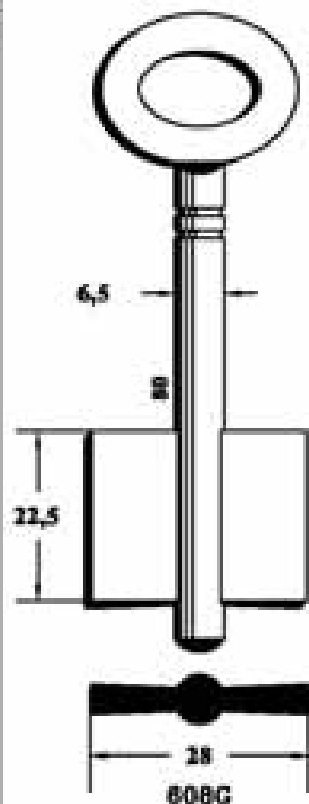

Copyright by
Alejandro Allina S.A.
2018

JMA

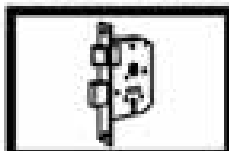

244

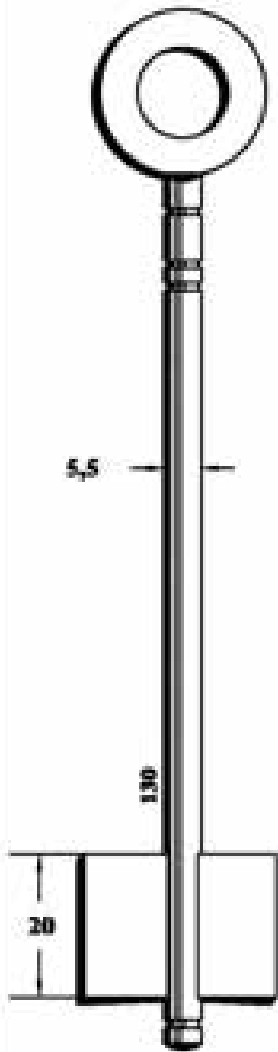

614G

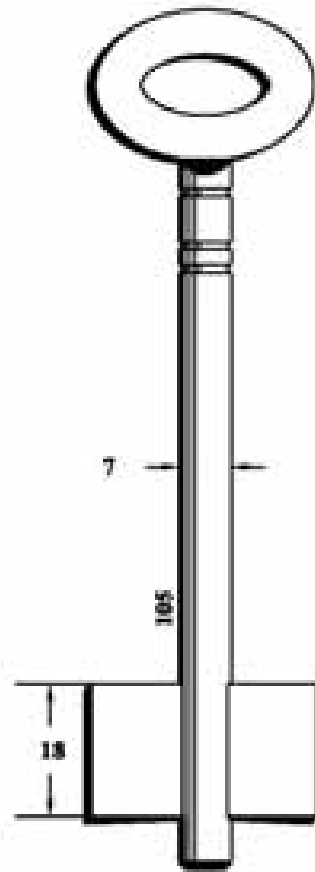

615G

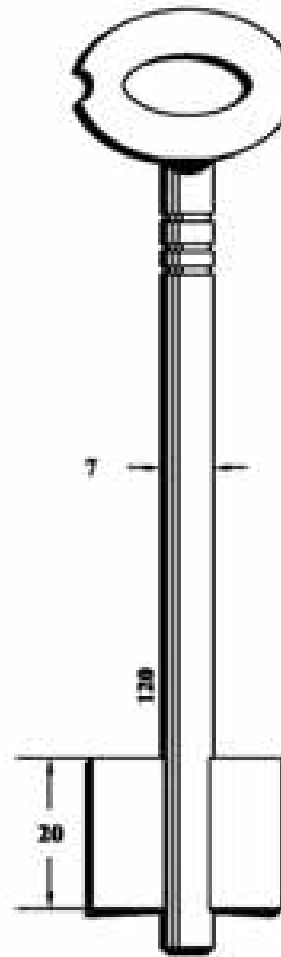

616G

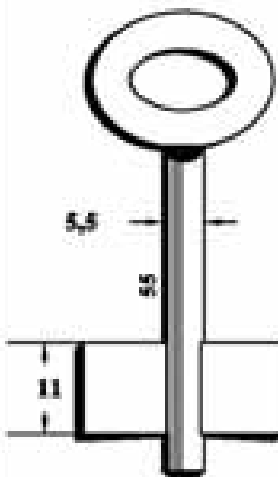

618G

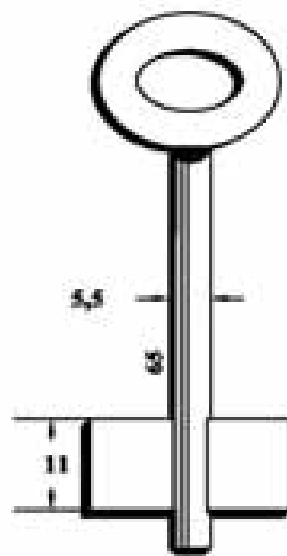

619G

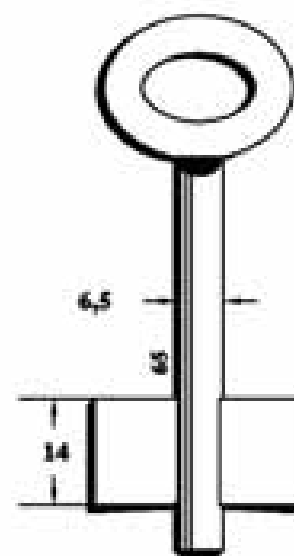

620G

Copyright by
Aljazeera Almiral S.A.
2018

JMA



245

PARA-FOR:

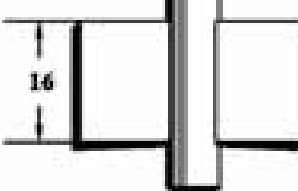
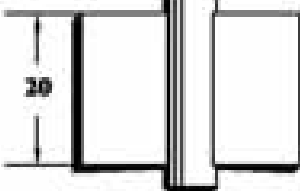
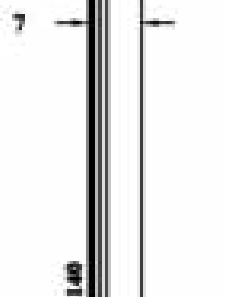
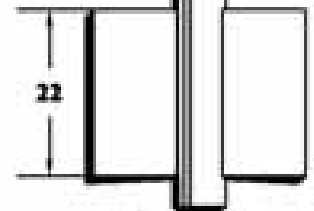
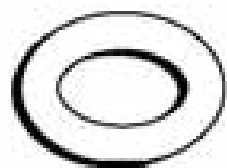
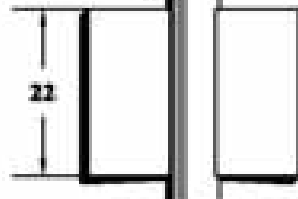
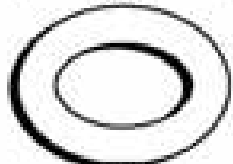
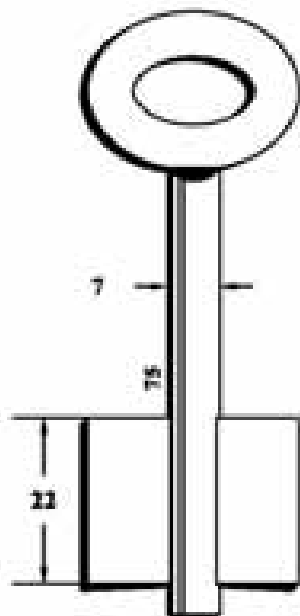

Copyright by
Alejandro Allina S.A.
2018

JMA

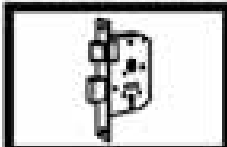

246



74G

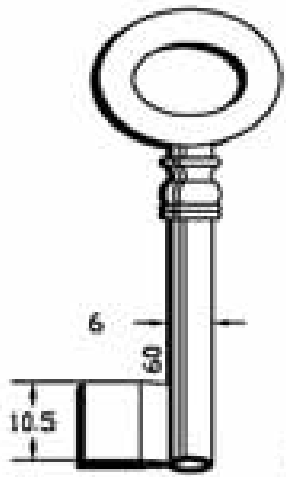

1200G

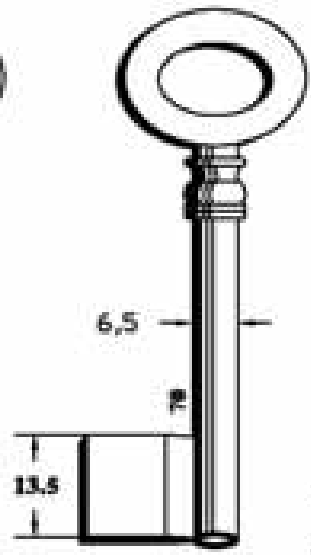

1201G

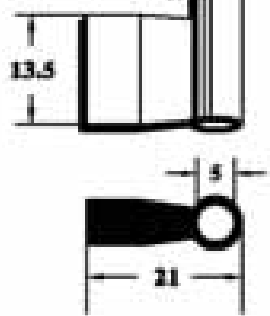
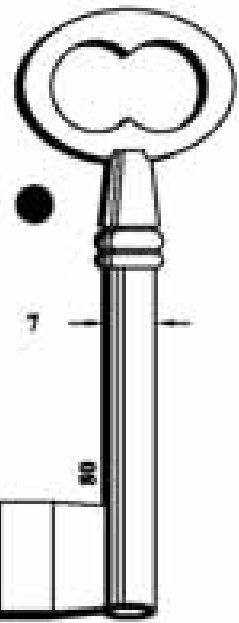

1202G

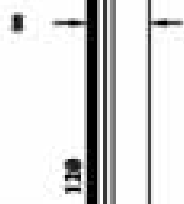

1206G

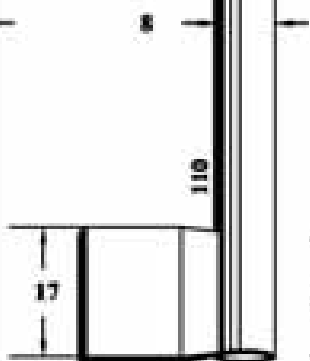
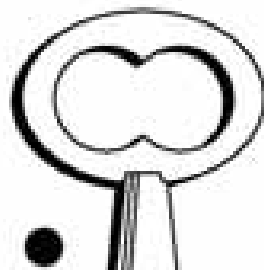

1205G

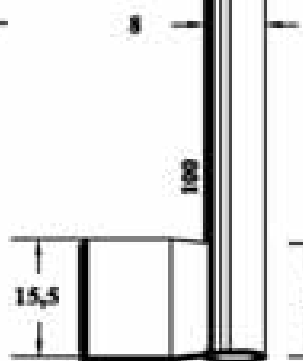
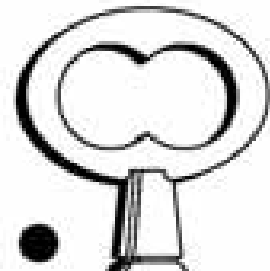

1204G

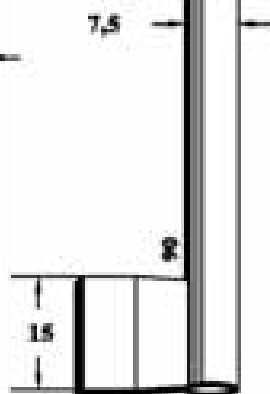

1203G

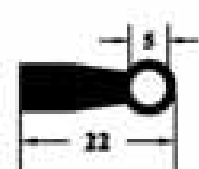

Copyright by
Algebra Almas S.A.
2010

JMA



247

PARA-FOR:

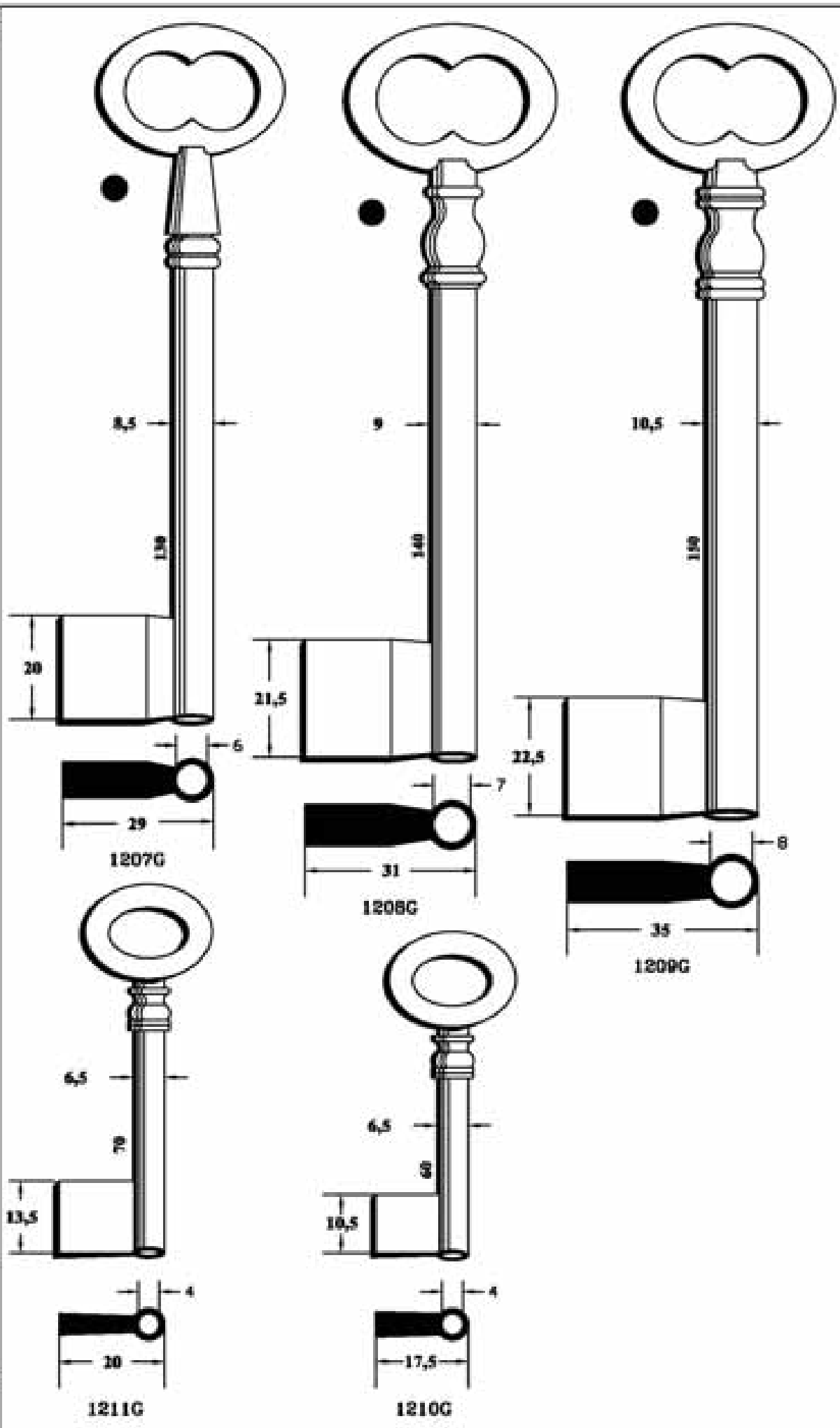

Copyright by
Alejandro Allina S.A.
2018

JMA

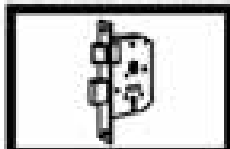

248

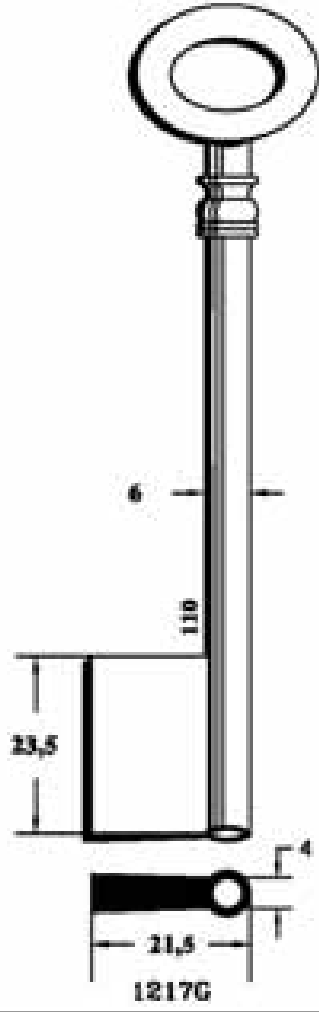
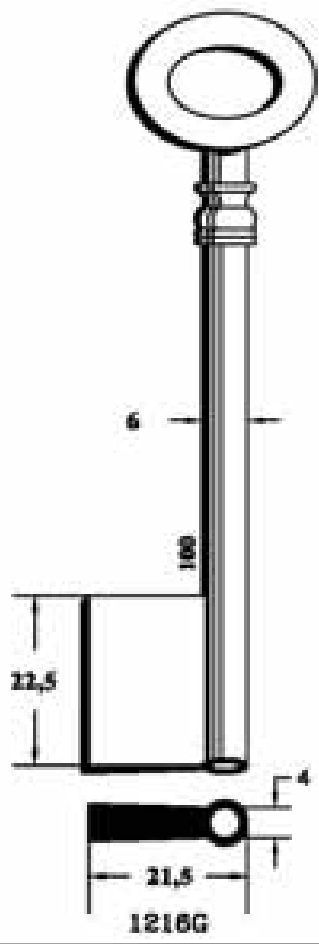
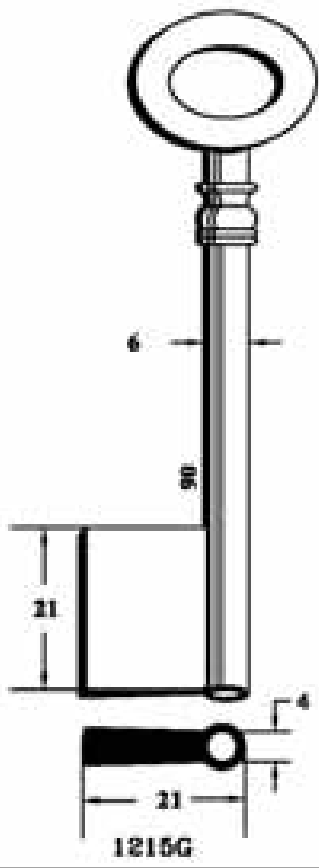
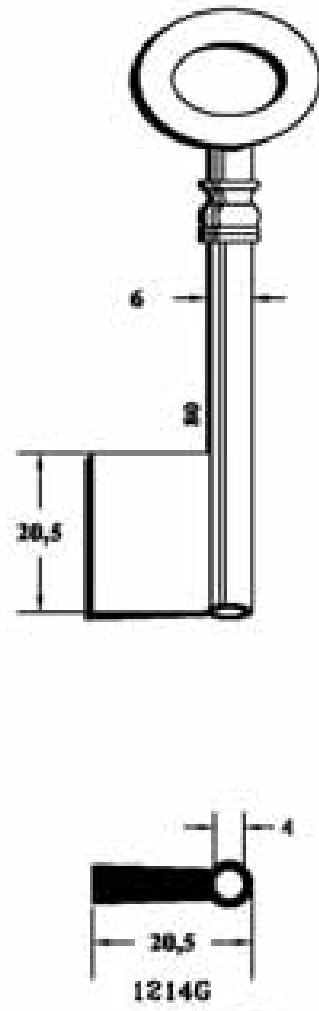
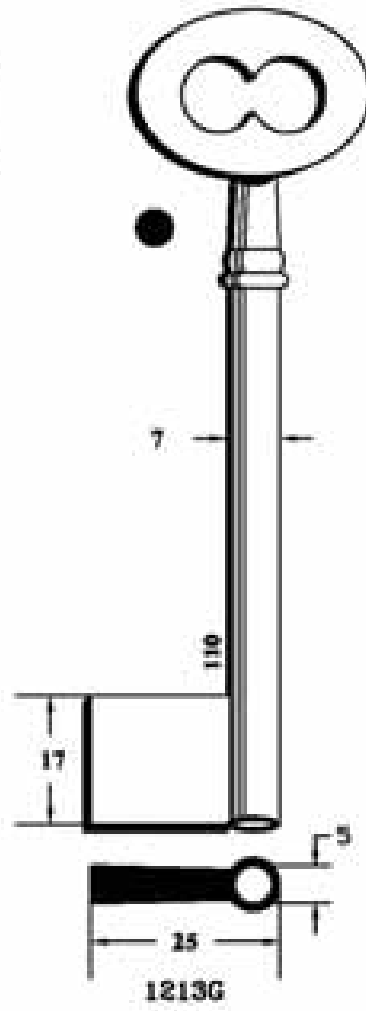
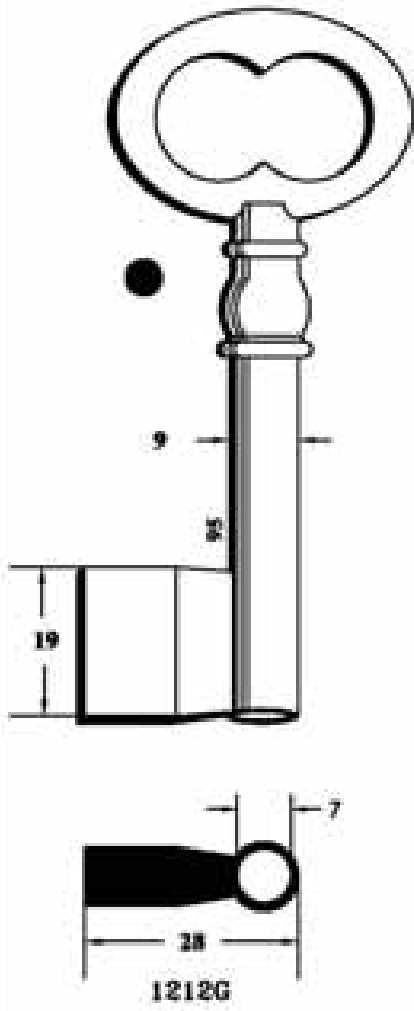

Copyright by
Algebra Almas S.A.
2018

JMA

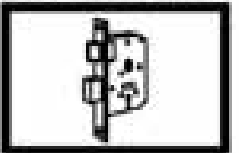

249

PARA-FOR:

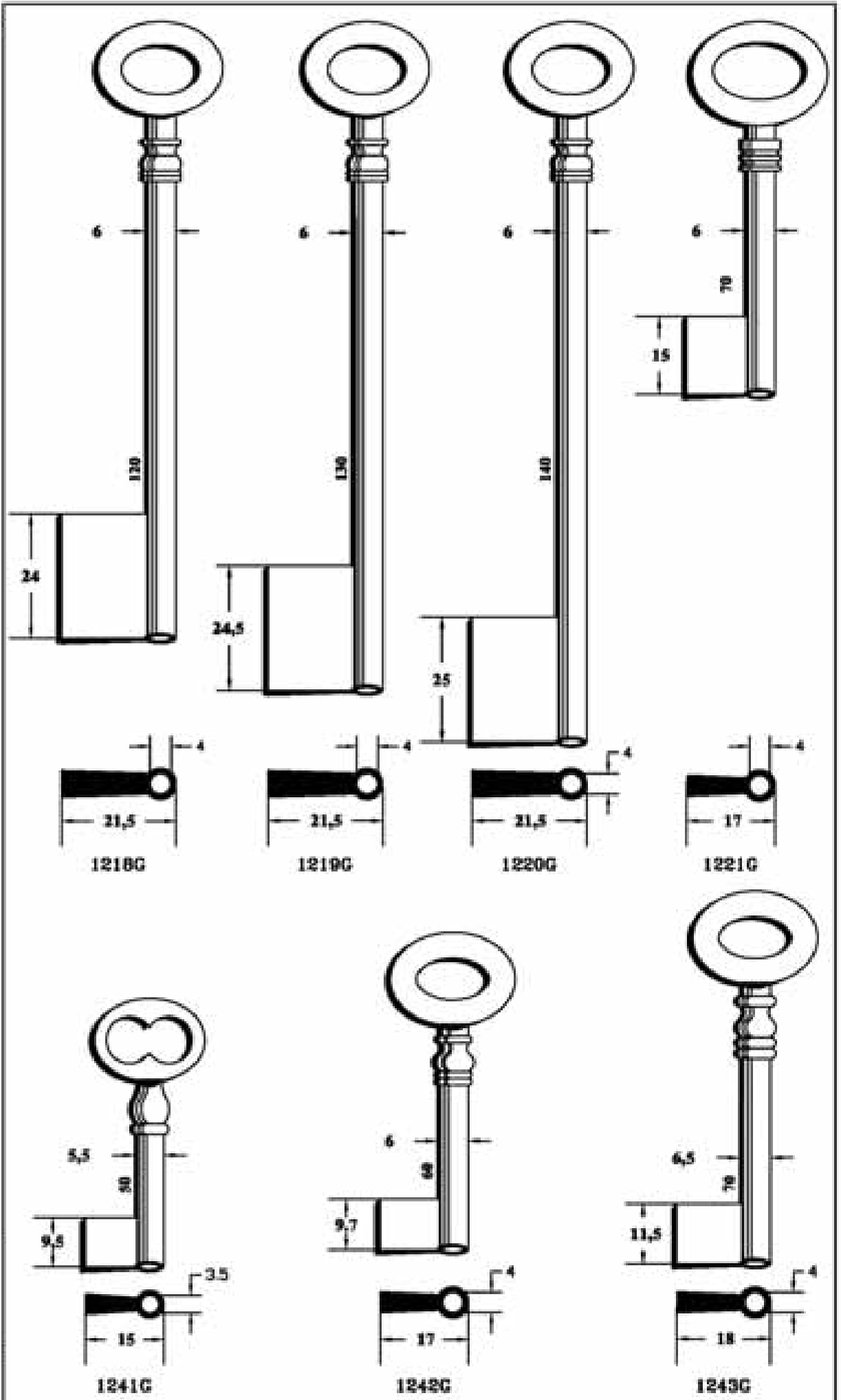

Copyright by
Alejandro Allina S.A.
2018

JMA



250

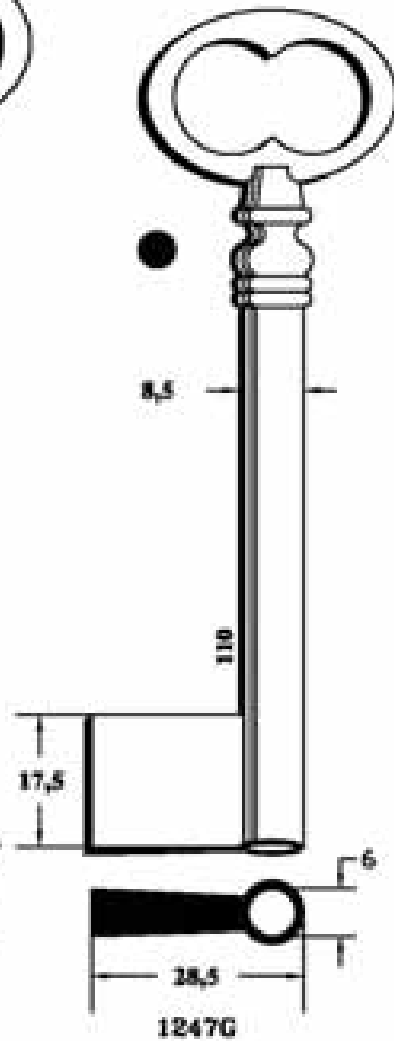
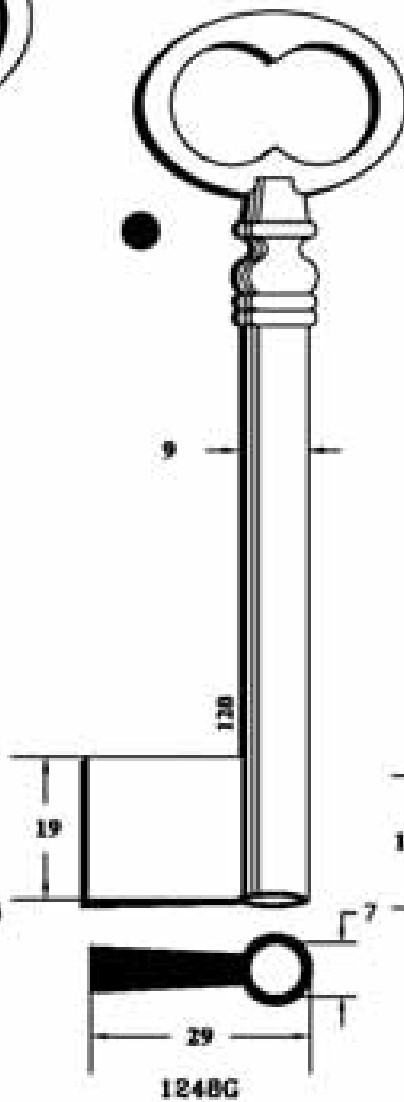
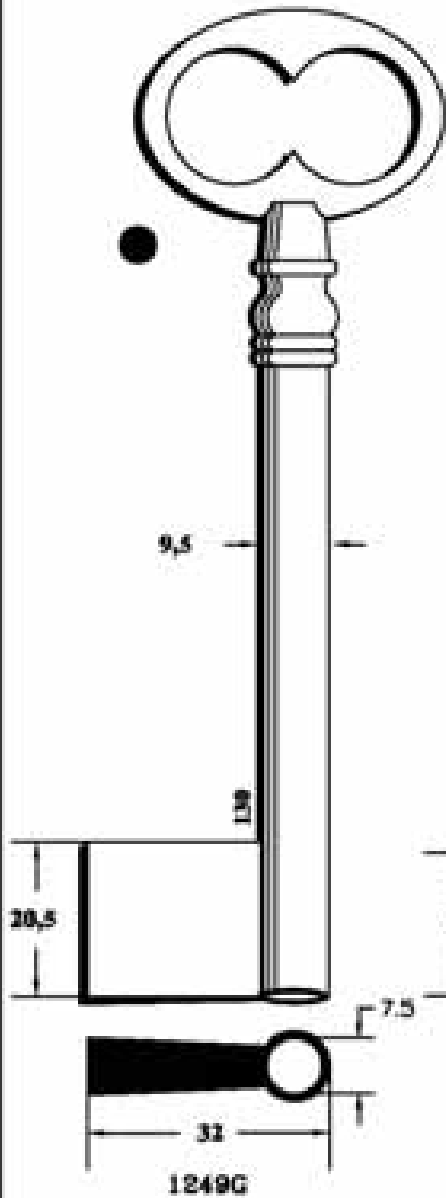
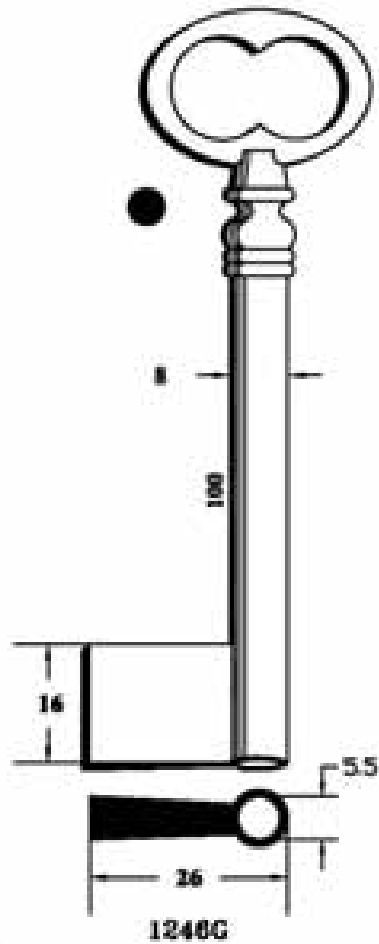
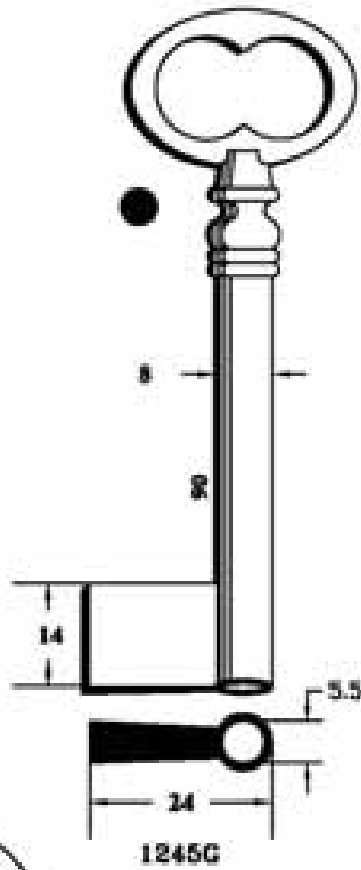
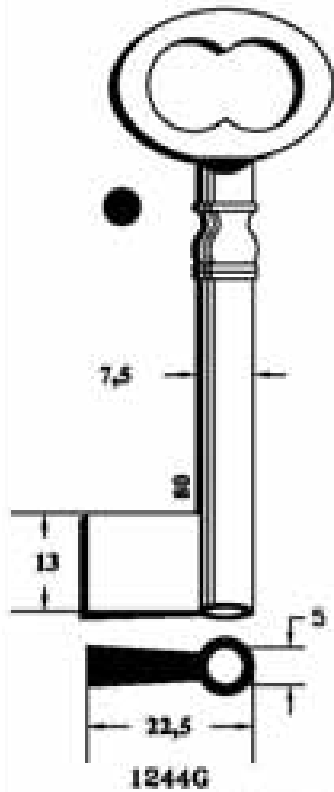

Copyright by
Algebra Almas S.A.
2018

JMA



251

PARA-FOR:

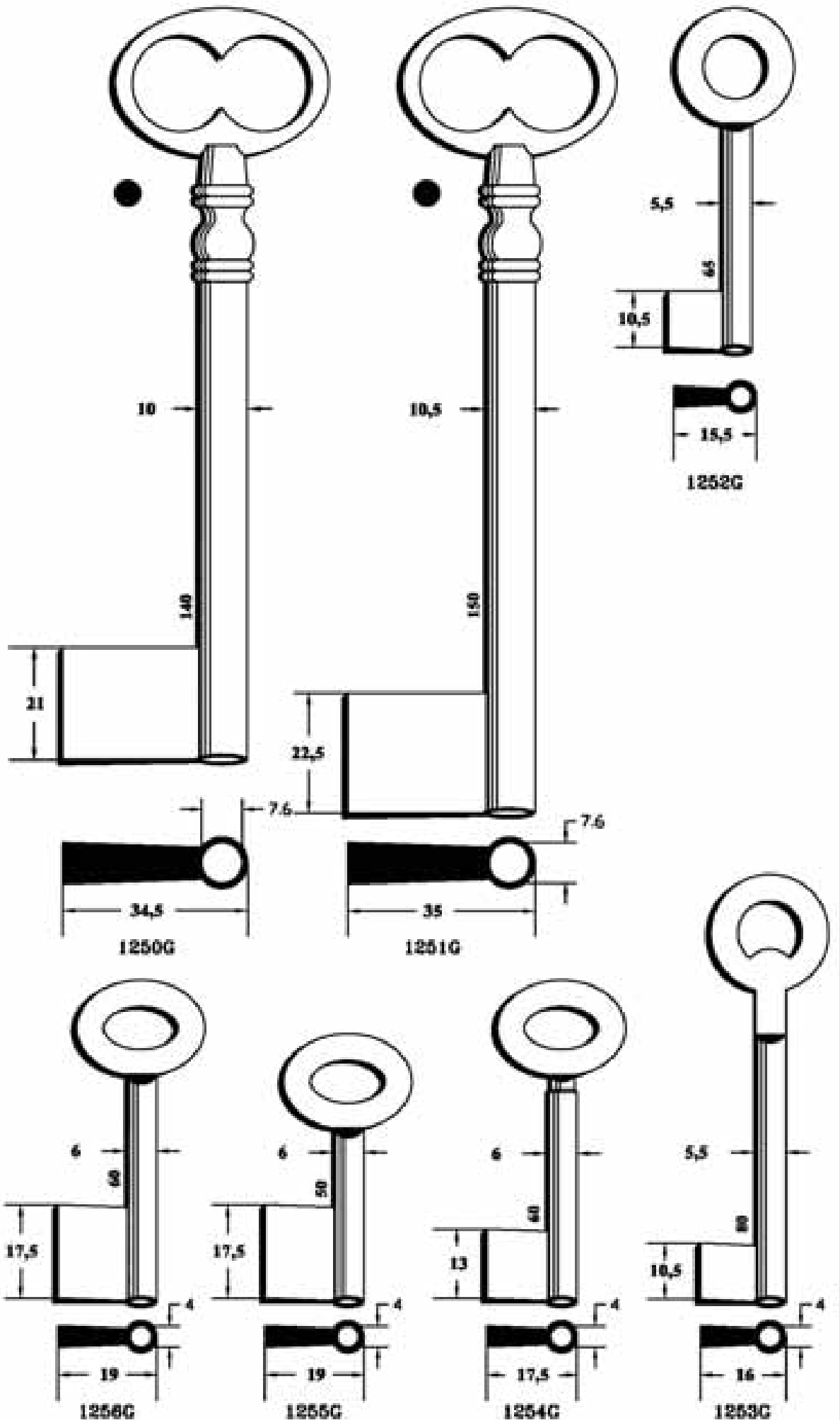

Copyright by
Alejandro Allina S.A.
2018

JMA



252

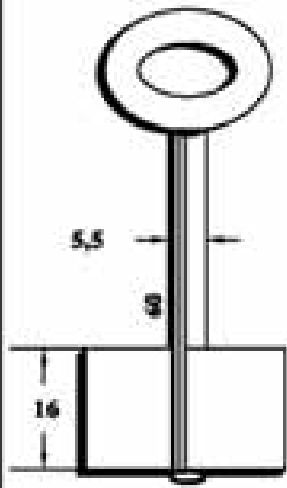

1600G

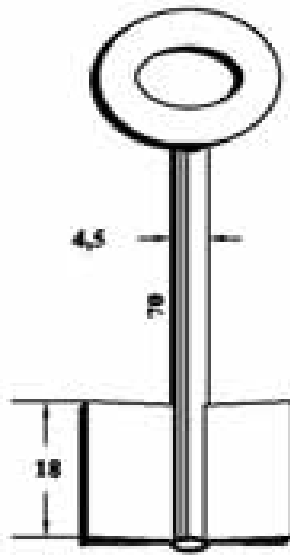

1601G

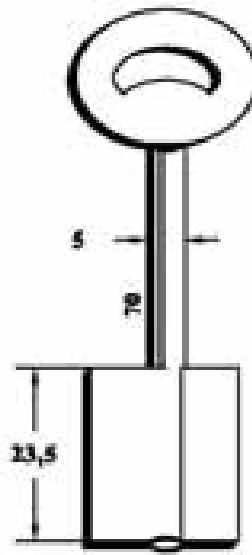

1602G

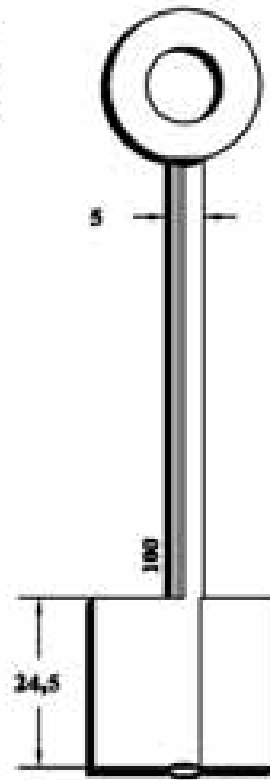

1603G

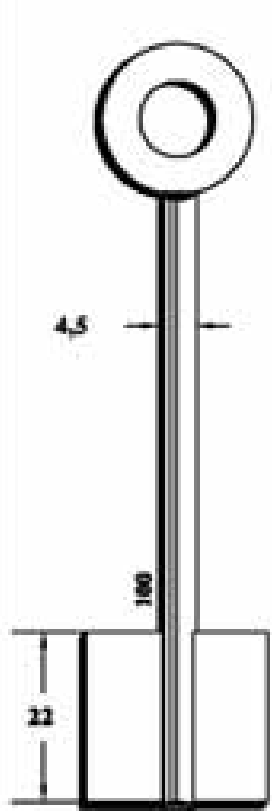

1604G

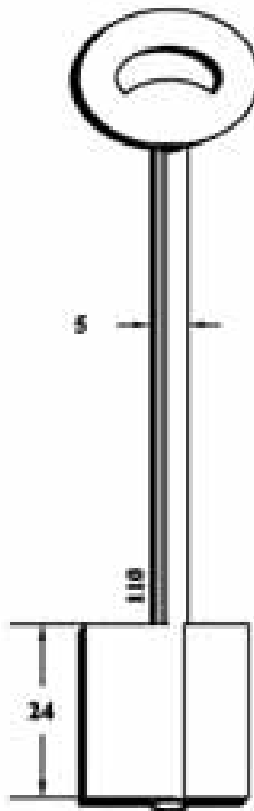

1605G

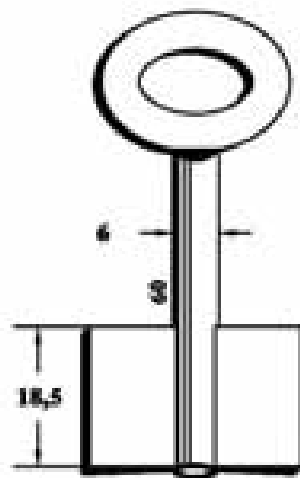

1606G

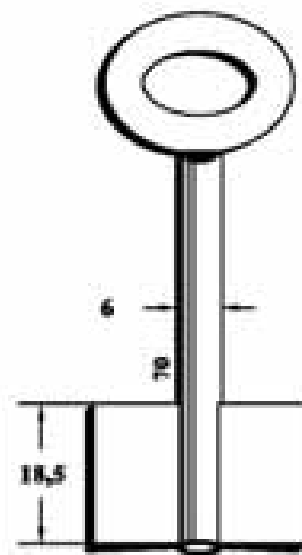

1607G

Copyright by
Algodoro Almas S.A.
2010

JMA



253

PARA-FOR:

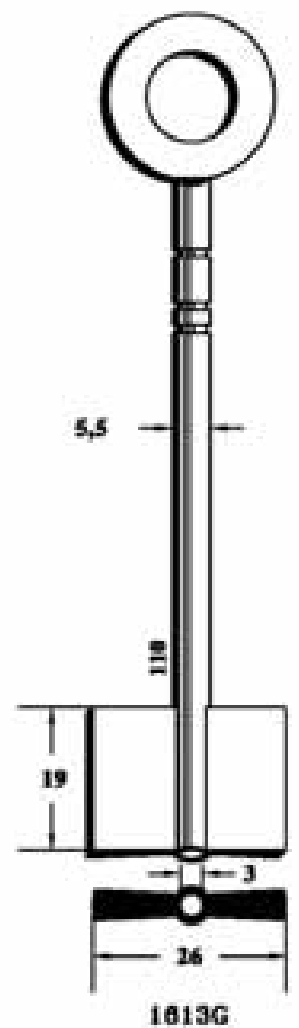
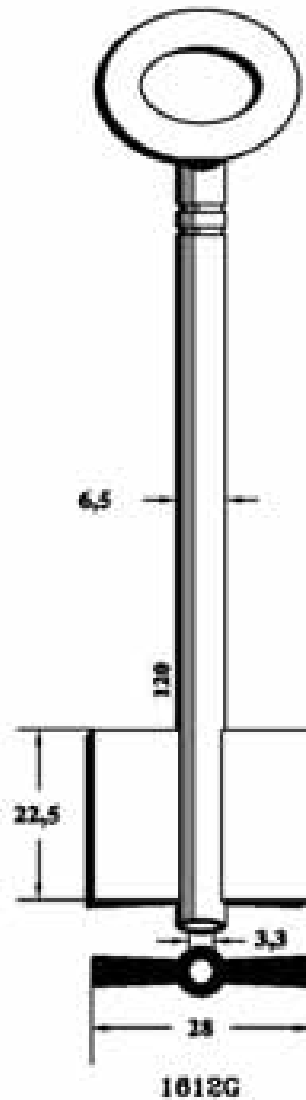
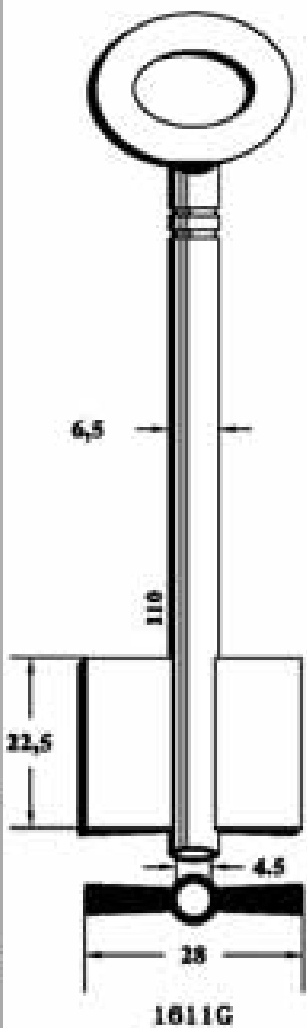
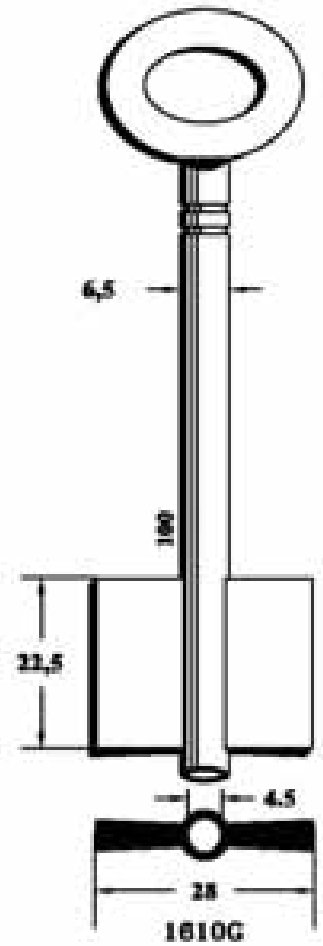
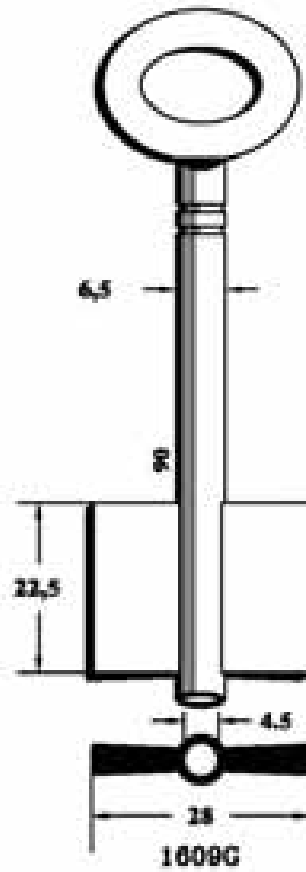
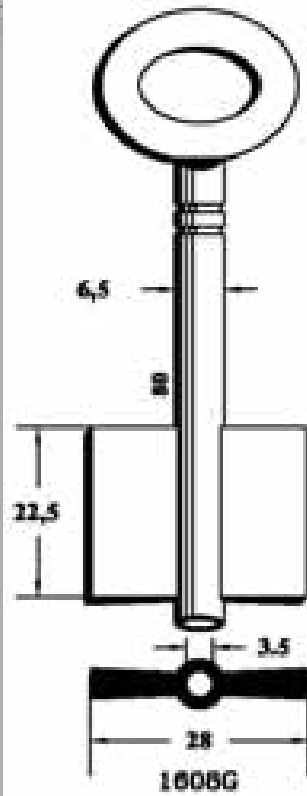

Copyright by
Alejandro Allina S.A.
2018

JMA



254

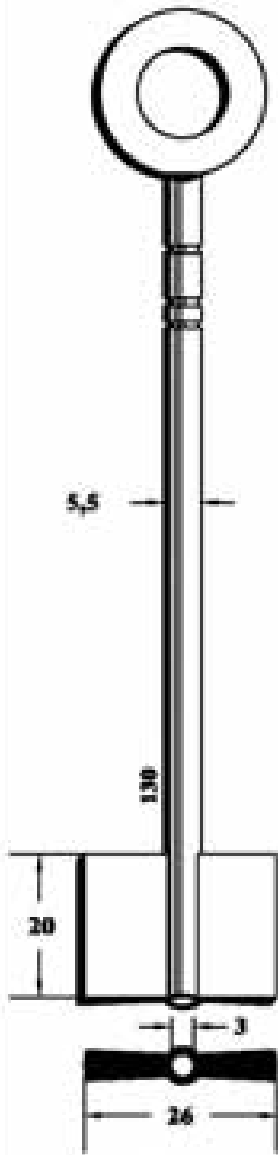

1614G

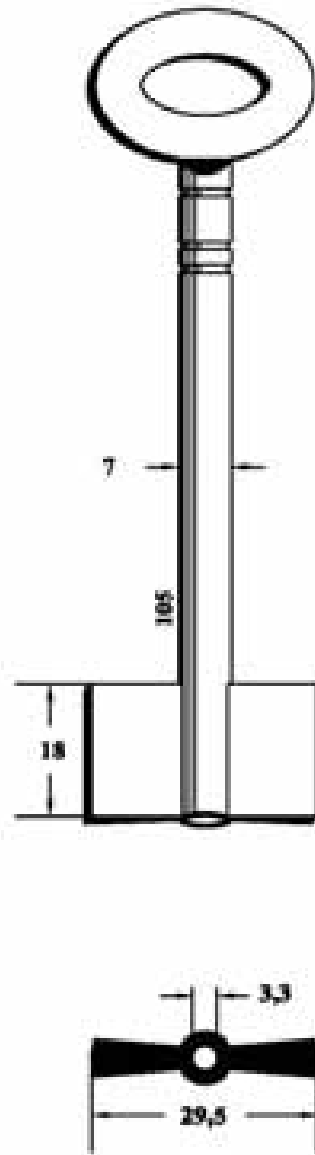

1615G

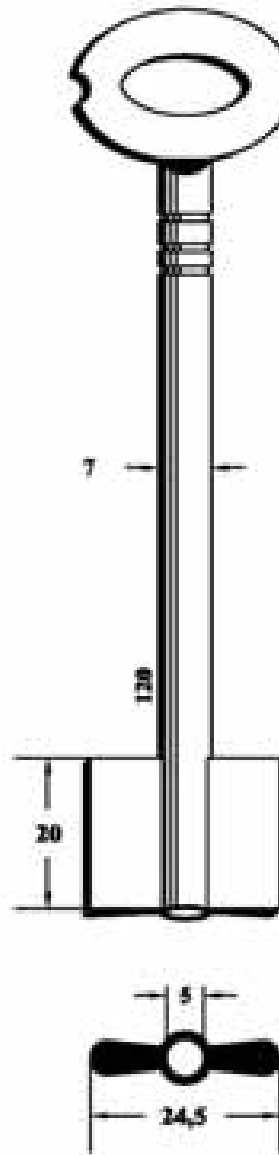

1616G

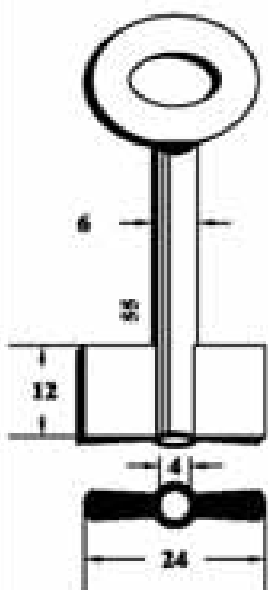

1617G

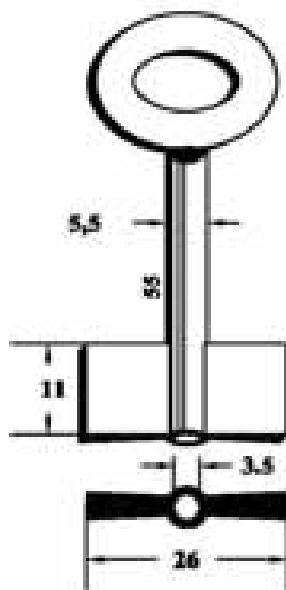

1618G

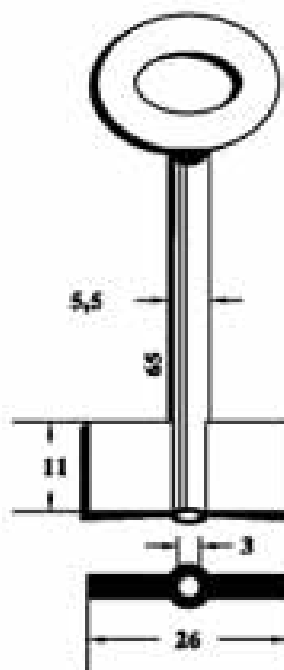

1619G

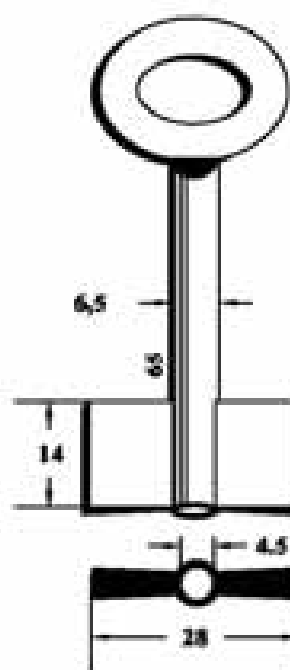

1620G

Copyright by
Alejandro Altman S.A.
2018



255

PARA-FOR:

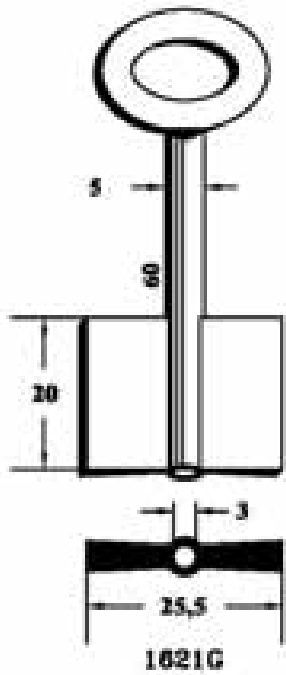

1621G

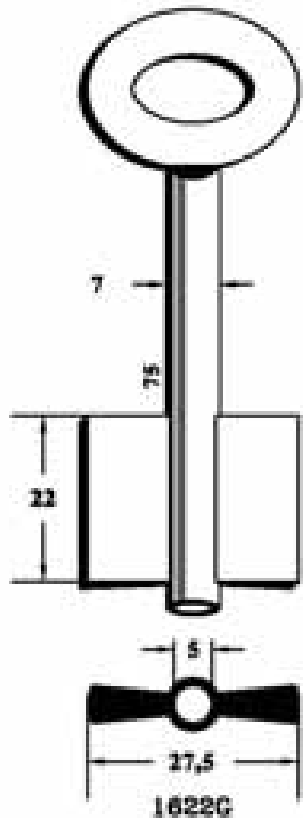

1622G

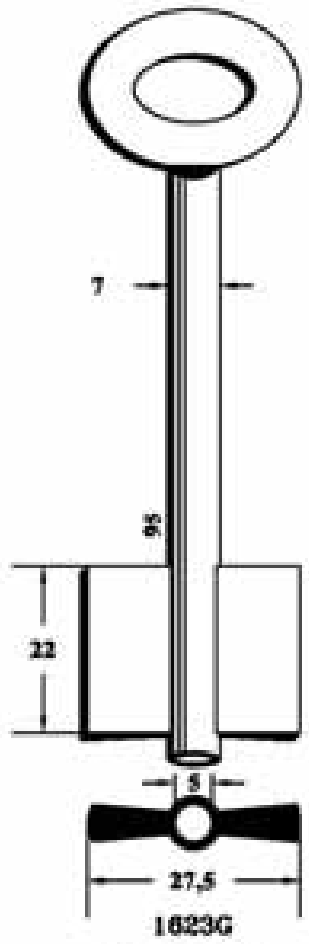

1623G

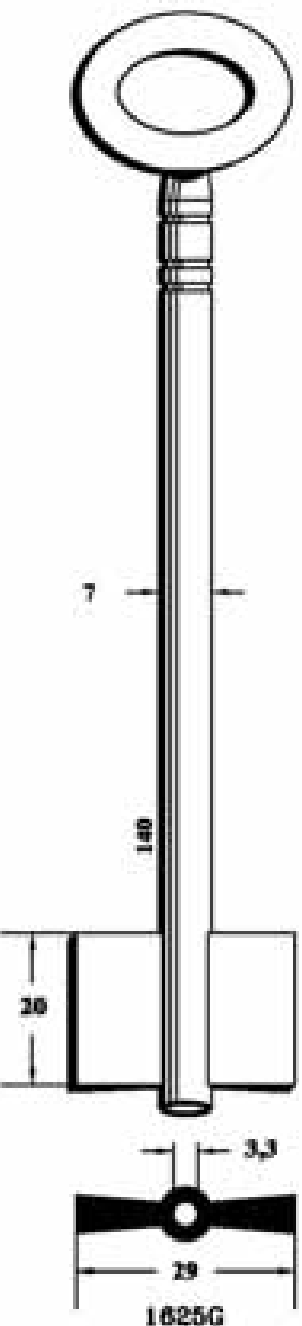

1625G

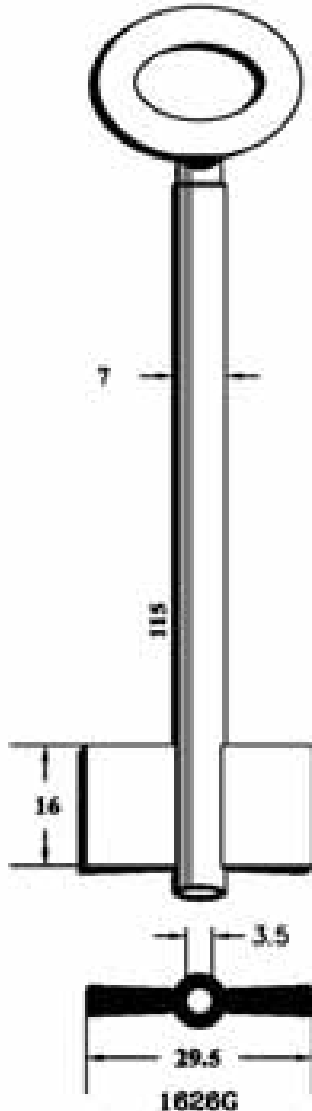

1626G

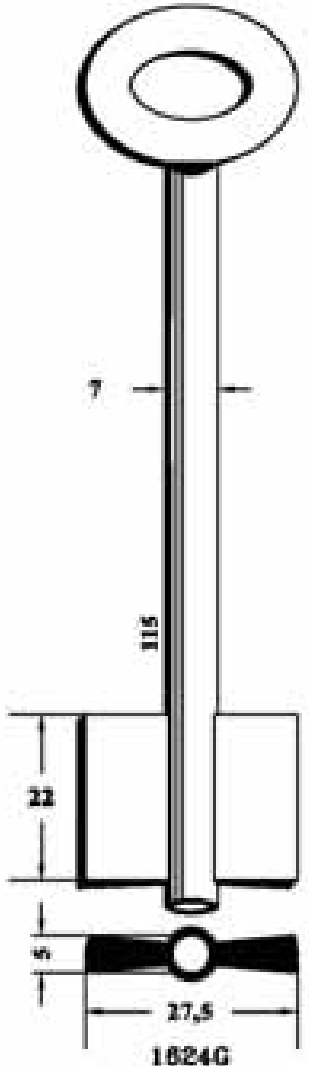

1624G

Copyright by
Alejandro Allina S.A.
2018

JMA

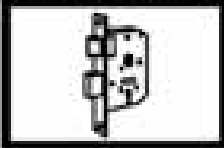

256

LLAVES DE GORJA LATÓN

LETOIZKO GORJA GILTZAK

BRASS BIT KEYS

CLÉS À GORGES EN LAITON

CHUBBSCHLÜSSEL AUS MESSING



THE KEY TO EXCELLENCE
GLOBALLY UNLOCKING MILLIONS OF DOORS DAILY

PARA-FOR:

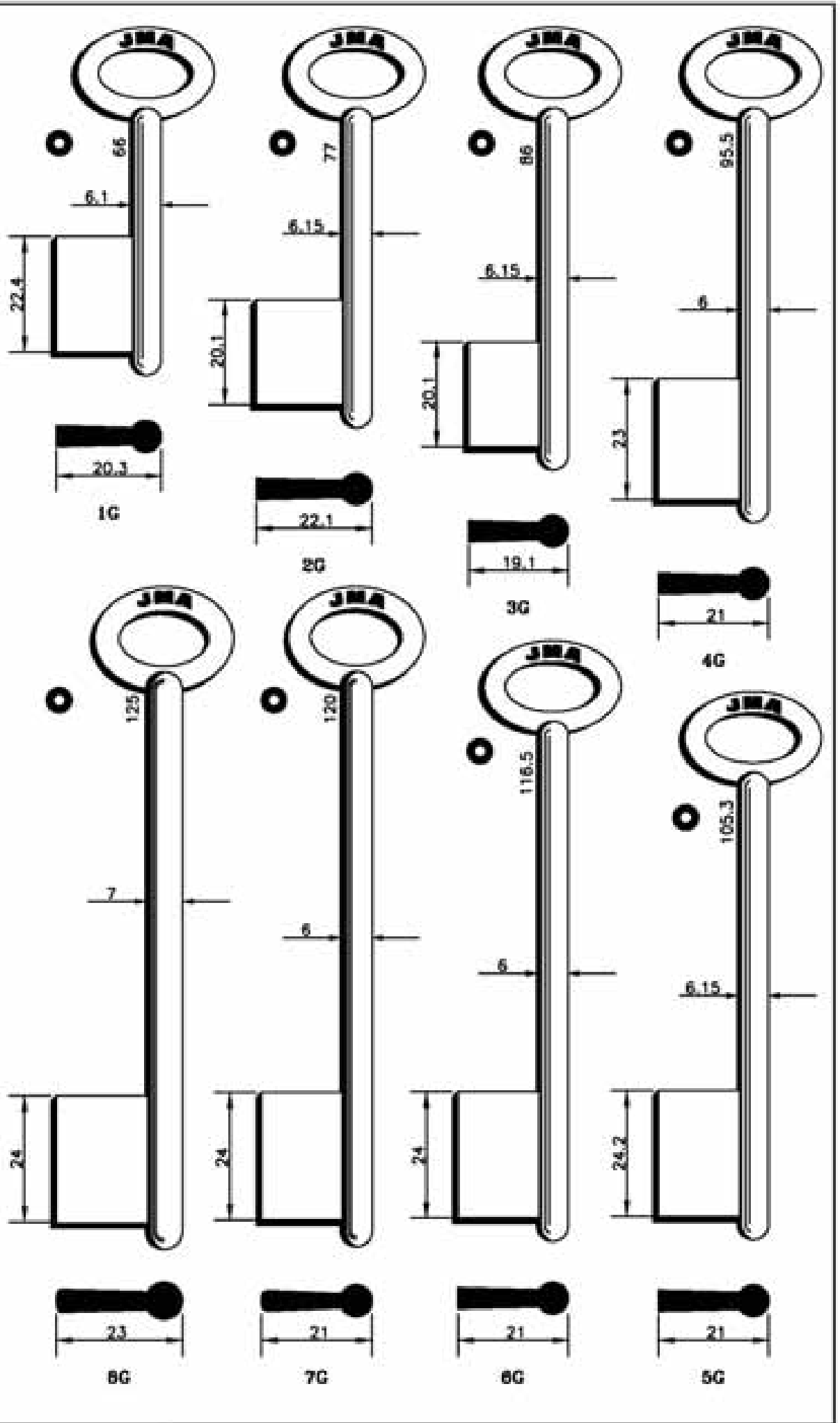

Copyright by
Algodoro Altimir S.A.
2018

JMA



258

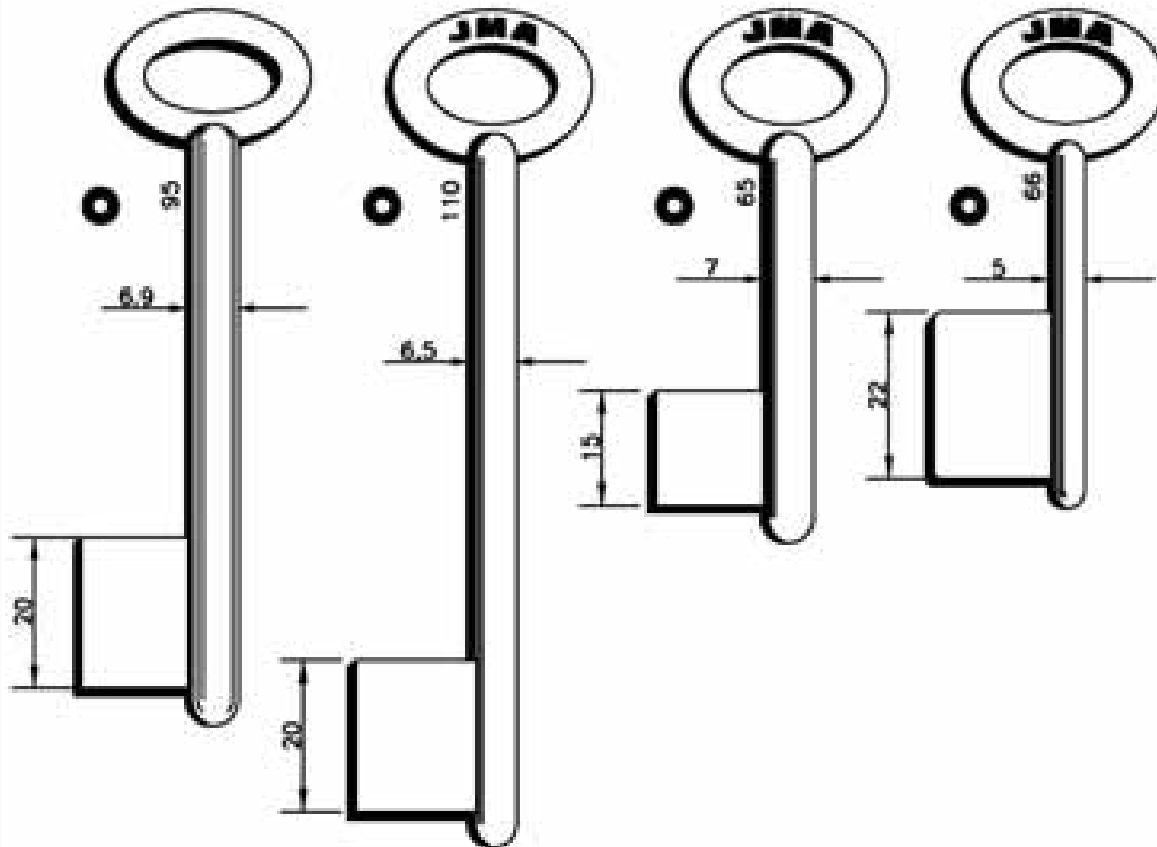

11G



12G

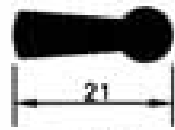

13G



14G

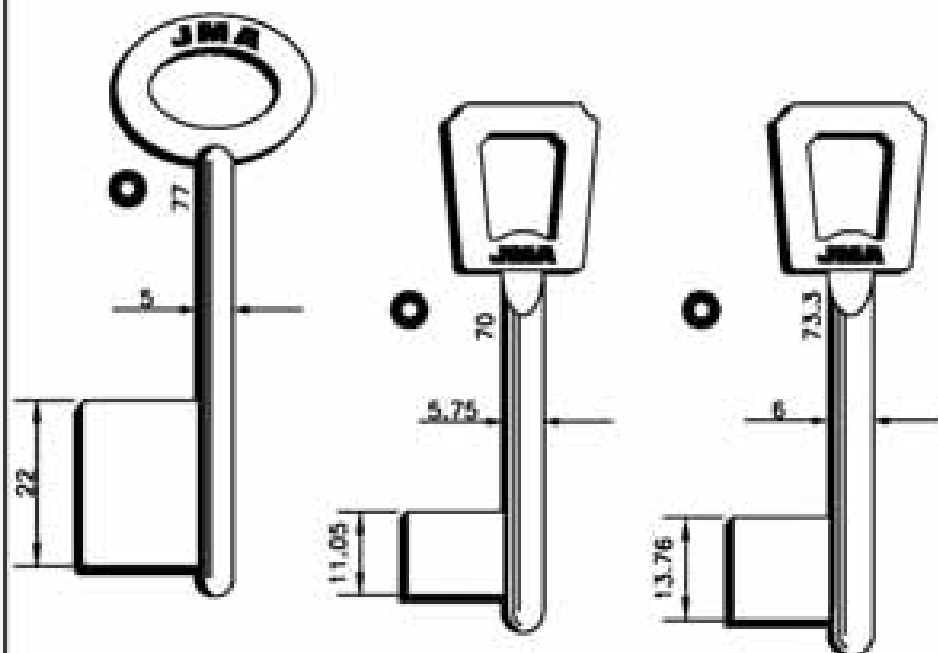

15G



16G

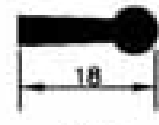

17G

Copyright by
Alejandro Altamir S.A.
2018



259

PARA-FOR:

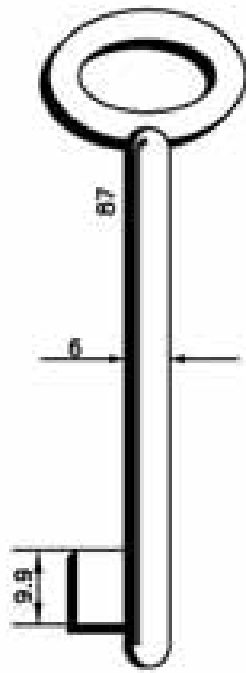

19G

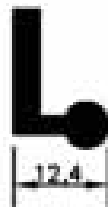

21G

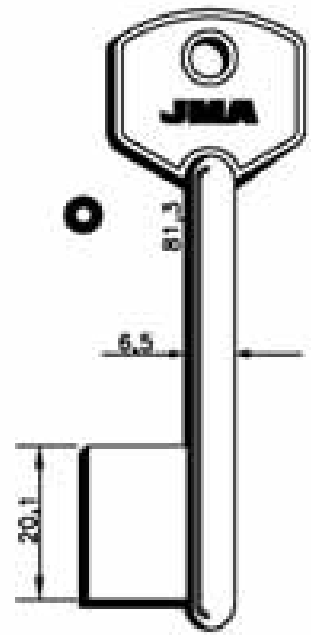
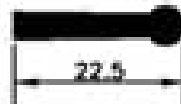

23G

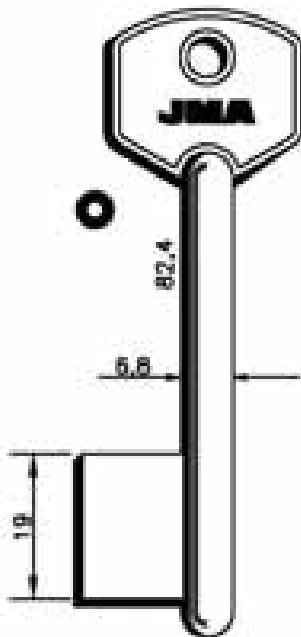

24G

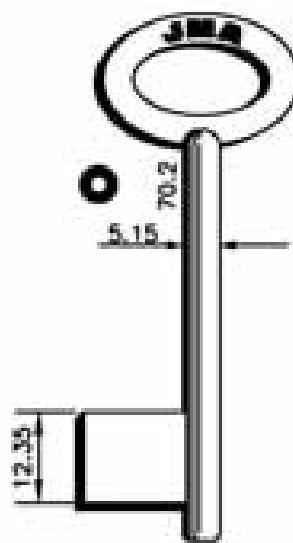

25G



Copyright by
Alfonso Allina S.A.
2008

JMA



260

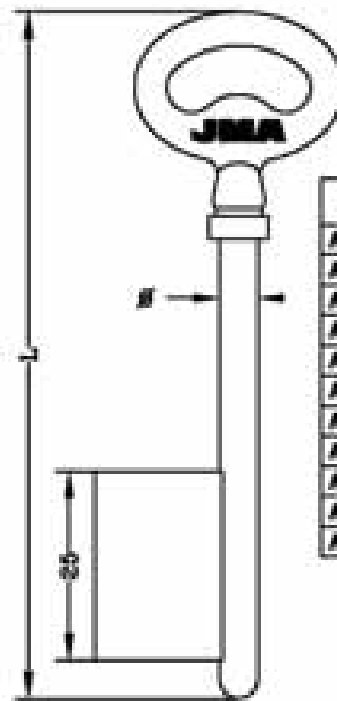
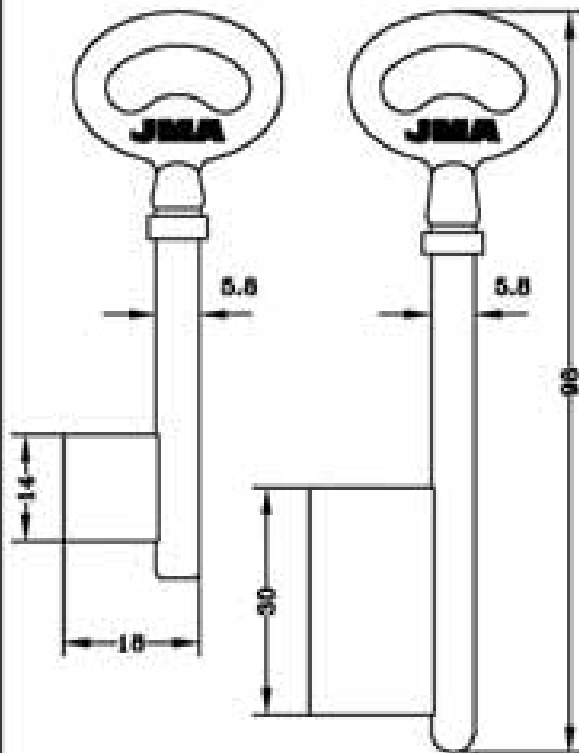

REF.	L	Ø
AD-3	90	5
AD-4	95	5
AD-5	100	5
AD-6	80	5,5
AD-7	95	5,5
AD-8	100	5,5
AD-9	80	5,8
AD-10	90	6
AD-11	95	6
AD-12	100	6
AD-13	100	6,5

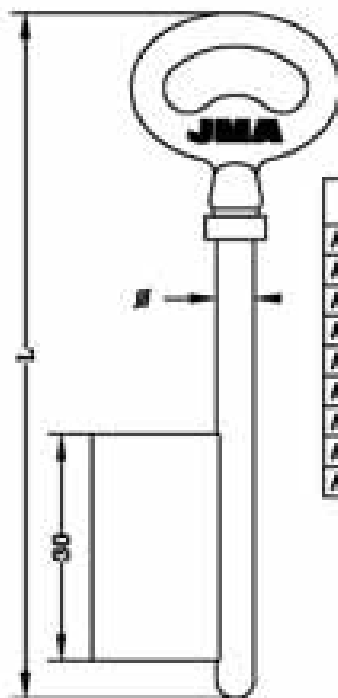
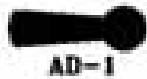

REF.	L	Ø
AD-16	110	5
AD-18	95	5,5
AD-19	110	5,5
AD-21	95	5,8
AD-23	110	6
AD-26	95	6,5
AD-27	110	6,5
AD-28	120	6,5
AD-29	100	6,5

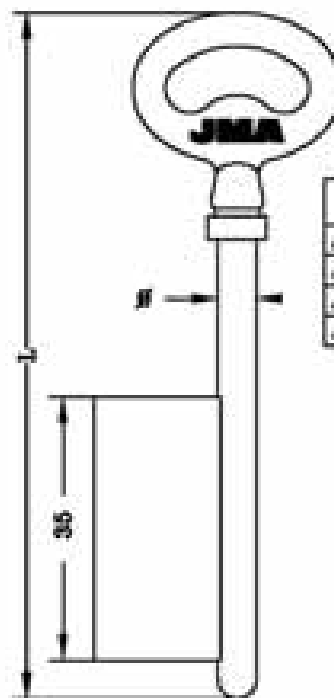

REF.	L	Ø
AD-17	120	5
AD-20	120	5,5
AD-24	120	6
AD-25	140	6



Copyright by
Alejandro Altamir S.A.
2018

JMA



261

PARA-FOR:

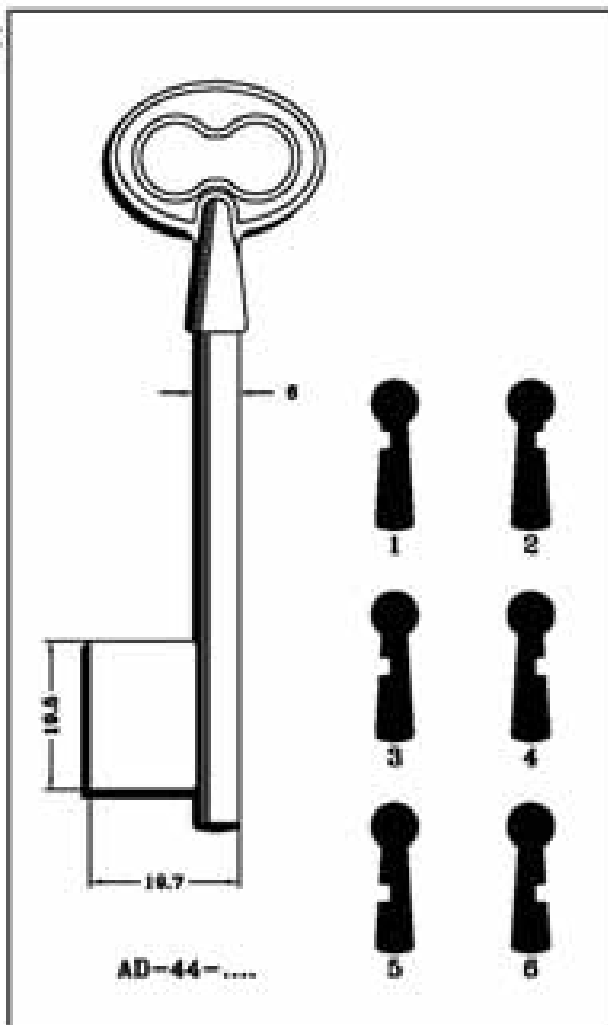

Copyright by
Alejandro Allina S.A.
2018

JMA



262

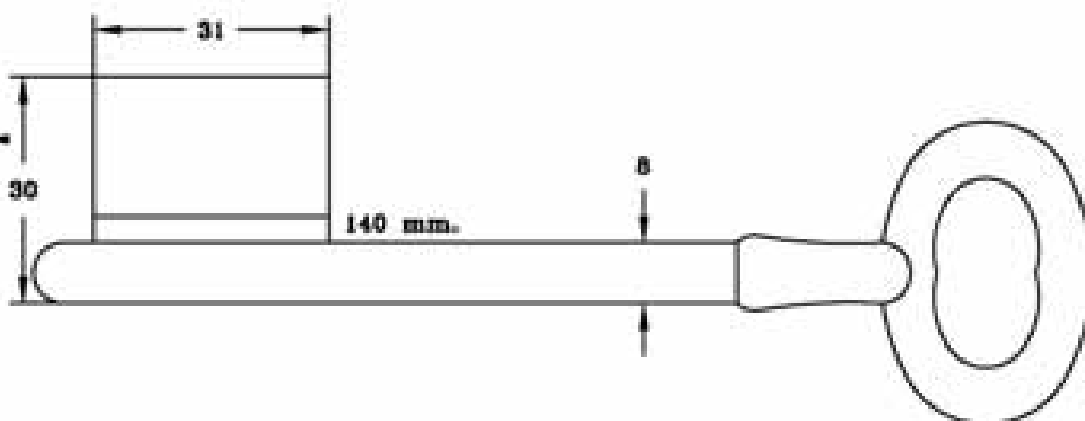
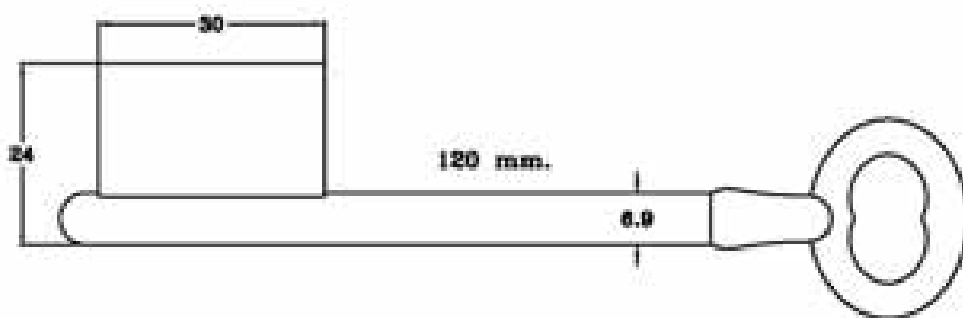
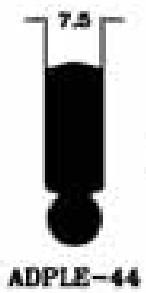
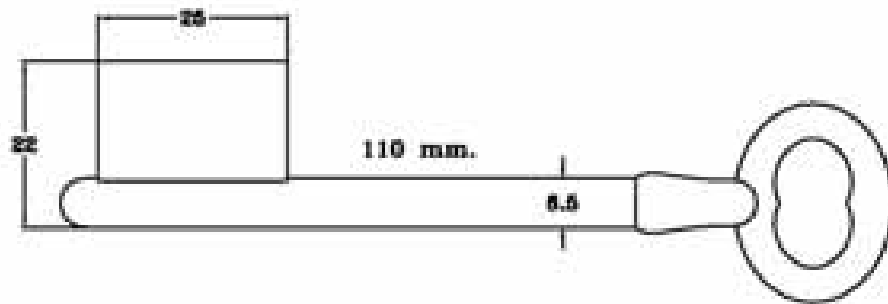
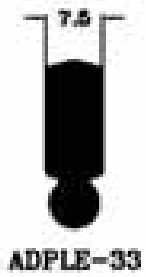
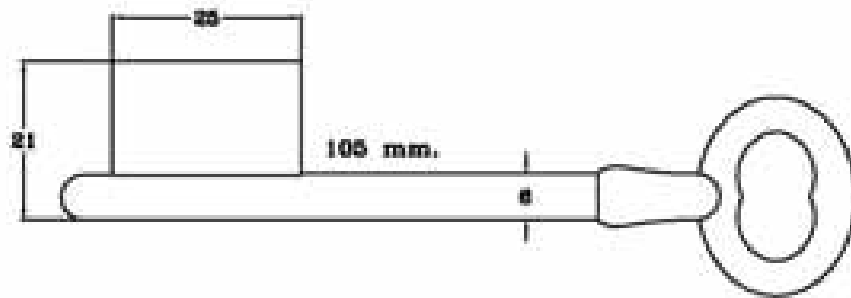
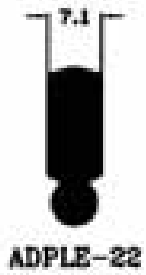
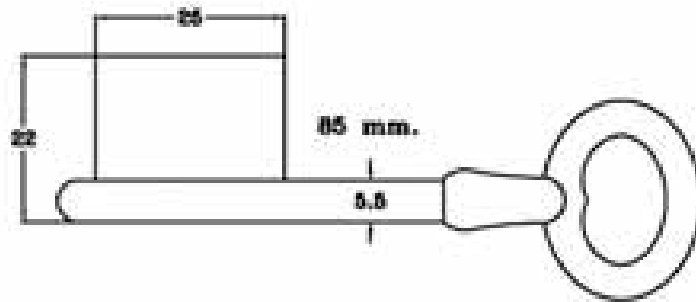
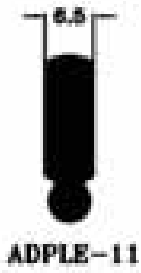

Copyright by
Alejandro Altuna S.A.
2010

JMA



263

PARA-FOR:

- 126 (S)
- AGA (E)
- ASSA (S)

PARA-FOR:	126			AGA
	126H-80G	126N-80G	126PP-80G	AGA-1G

PARA-FOR:	ASSA			
	AS-1G	AS-2G	AS-3G	AS-8G/1

Copyright by
Alfonso Allina S.A.
2018

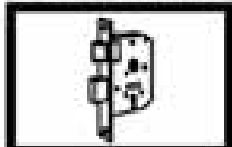

264

PARA:
FOR:

ASSA

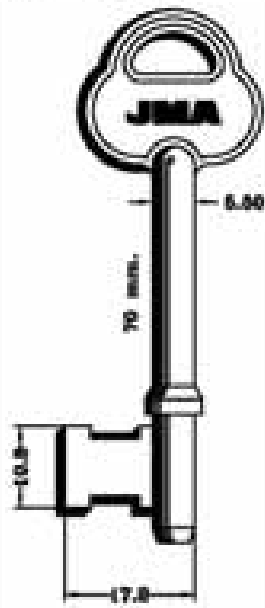

BODA

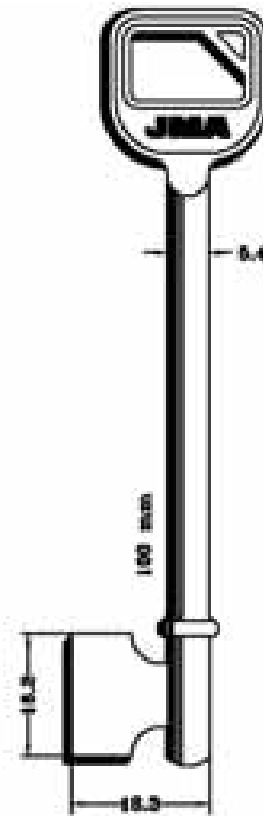
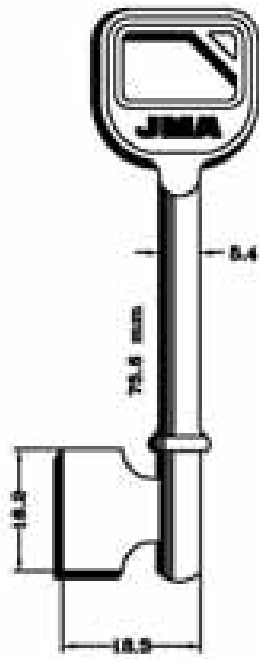

PARA-FOR:

ASSA (S)

BODA (SF)

BRICARD (F)

CHUBB (GB)

PARA:
FOR:

BRICARD

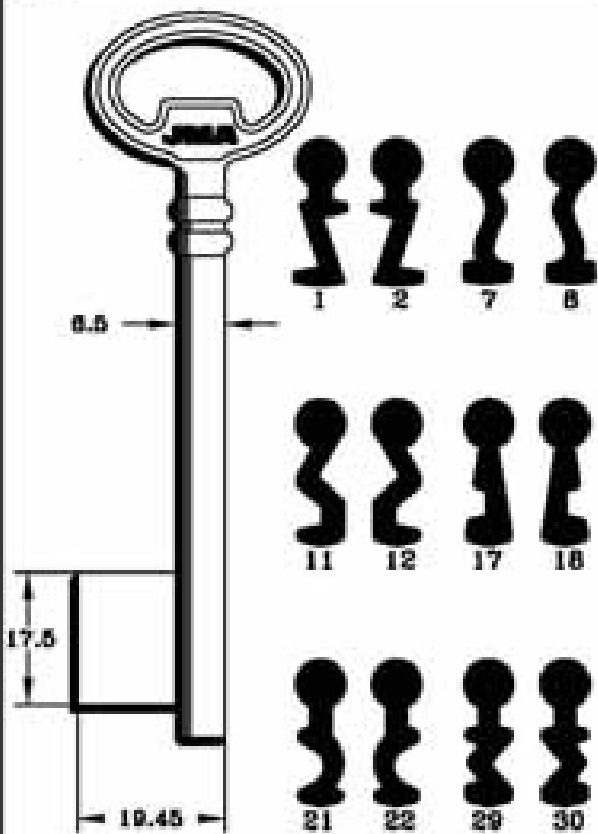

BRI-6L...

CHUBB

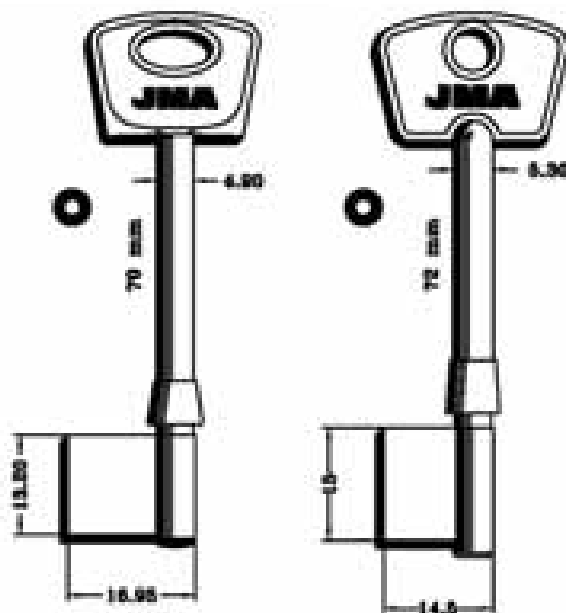

Copyright by
Alejandro Altuna S.A.
2018

JMA

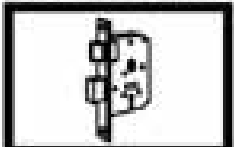

265

PARA-FOR:

DAR-MAR (PL)

DEBEAURAIN (F)

ELZETT (H)

PARA-FOR:

DAR-MAR

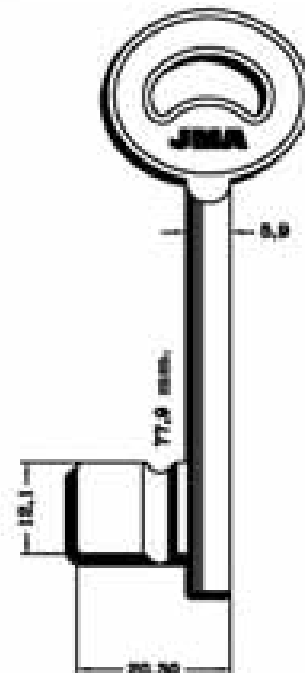
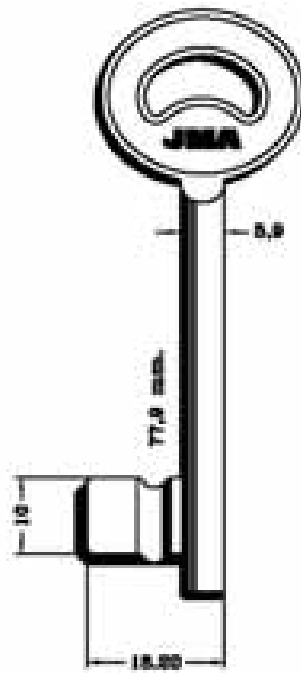

DMR-6-1



DMR-6-3

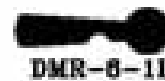

DMR-6-1L



DMR-6-3L



DMR-6-2

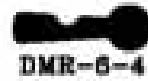

DMR-6-4



DMR-6-2L

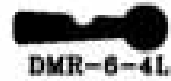

DMR-6-4L

PARA-FOR:

DAR-MAR

DEBEAURAIN

ELZETT

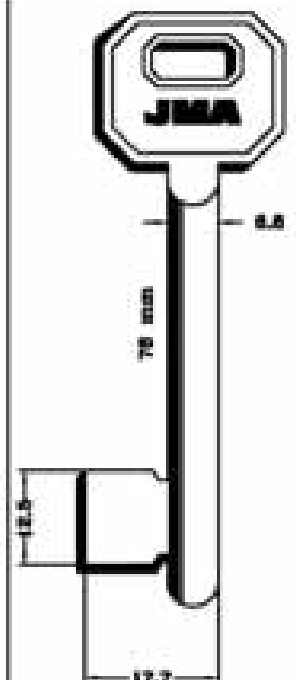
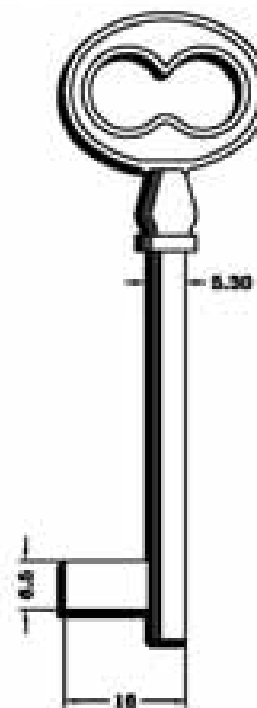
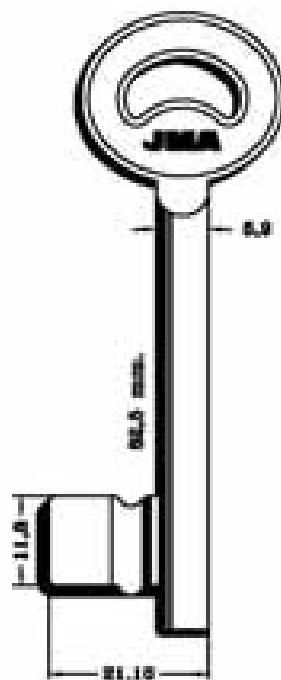

DMR-7-1



DMR-7-3



DMR-7-2



DMR-7-4

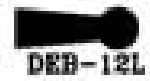

DEB-12L



ELZ-2G



ELZ-3G

Copyright by
Alejandro Allina S.A.
2018

JMA



266

PARA:
FOR: **ELZETT**

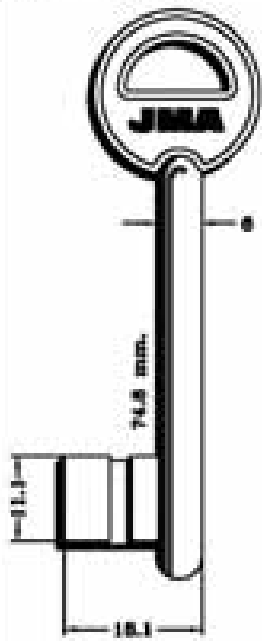

ELZ-5G



ELZ-8G

ERA

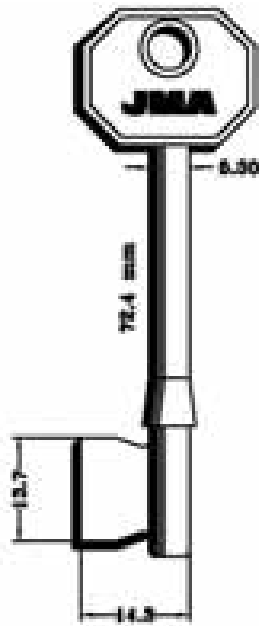

ER-1G

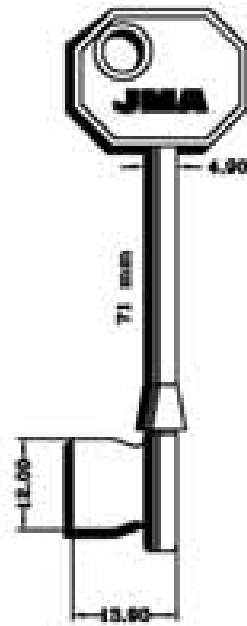

ER-4G

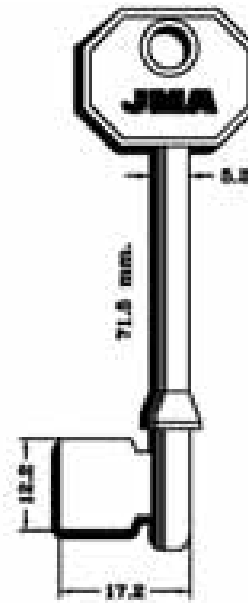

ER-5G

PARA-FOR:

ELZETT (H)

ERA (GB)

ESA (E)

FAS YALE (S)

PARA:
FOR: **ESA**



ES-1G

FAS-YALE

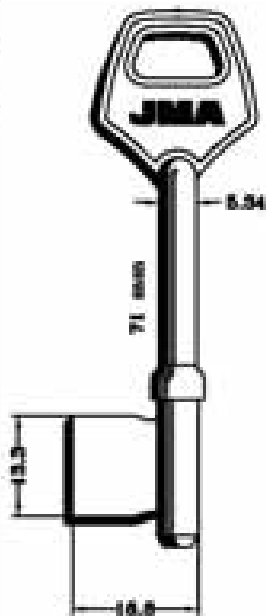

FA-1G

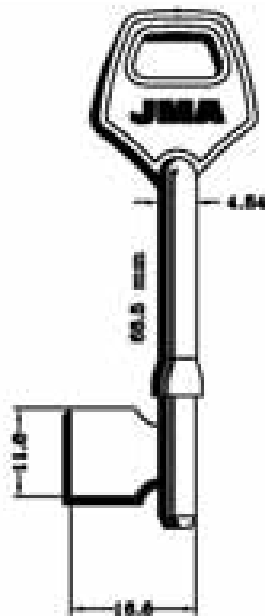

FA-2G

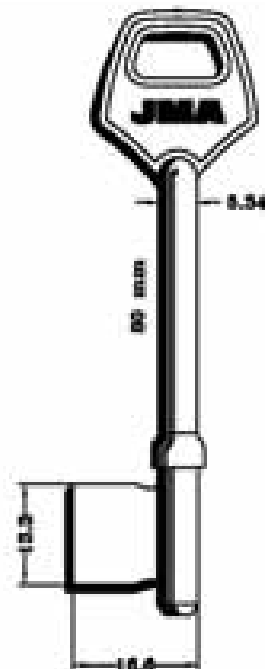

FA-3G

Copyright by
Alejandro Altamir S.A.
2018

JMA



267

PARA-FOR:

- FAS YALE (S)**
- FICHET (F)**
- GPZ (RUS)**
- GUARDIAN (GB)**
- HENDERSON (GB)**

PARA FOR:

FAS-YALE

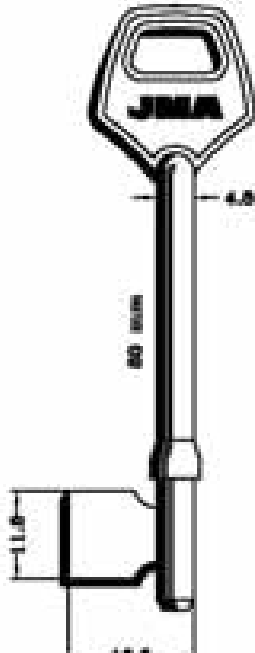
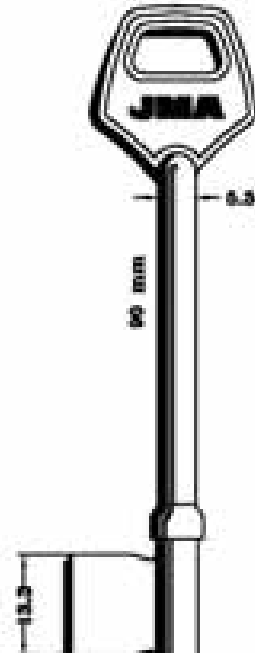
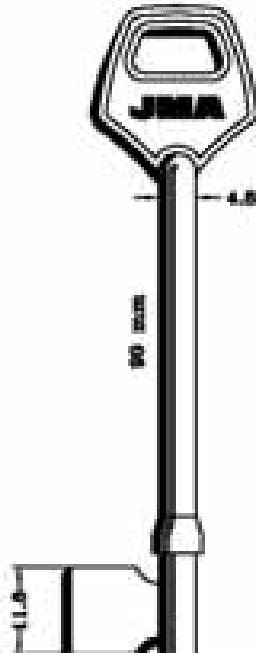
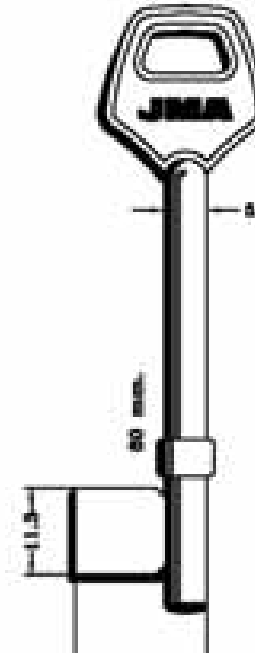
 <p>FA-4G</p>	 <p>FA-5G</p>	 <p>FA-6G</p>	 <p>FA-7G</p>
--	--	---	--

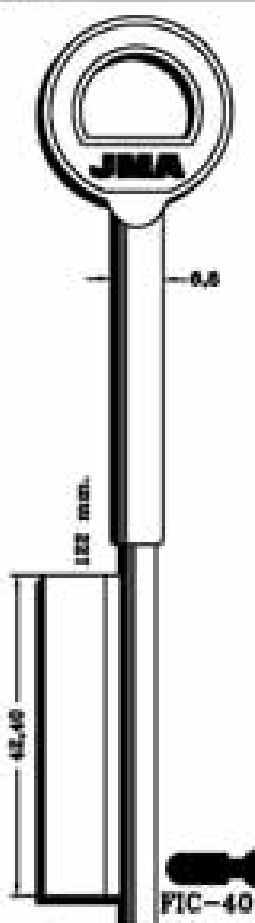
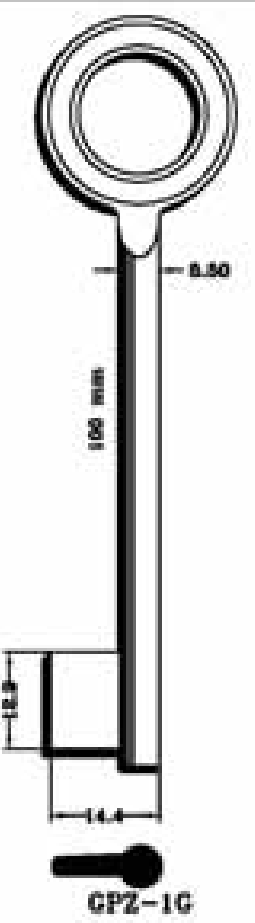
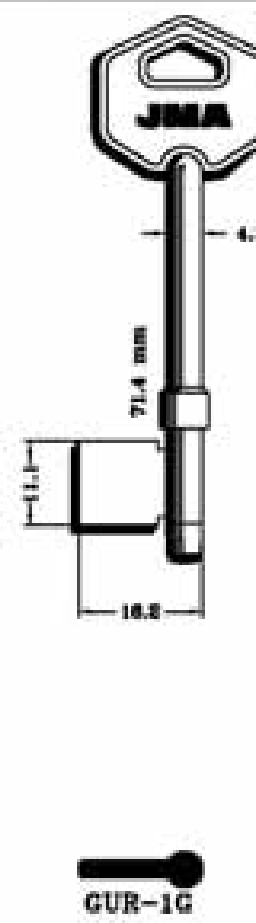
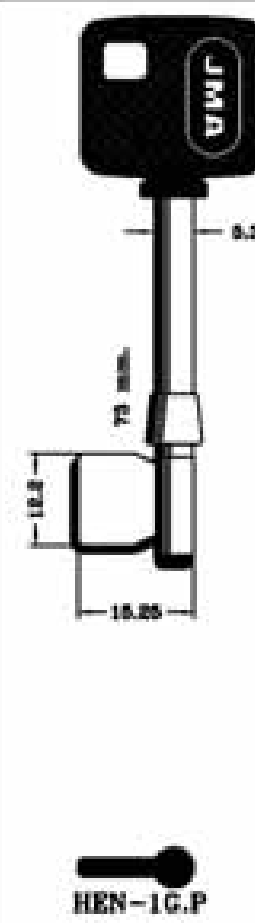
PARA FOR:	FICHET	GPZ	GUARDIAN	HENDERSON
	 <p>FIC-401G</p>	 <p>GPZ-1G</p>	 <p>GUR-1G</p>	 <p>HEN-1G.P</p>

Copyright by
Alfonso Allina S.A.
2018

JMA



268

PARA-FOR: LAR

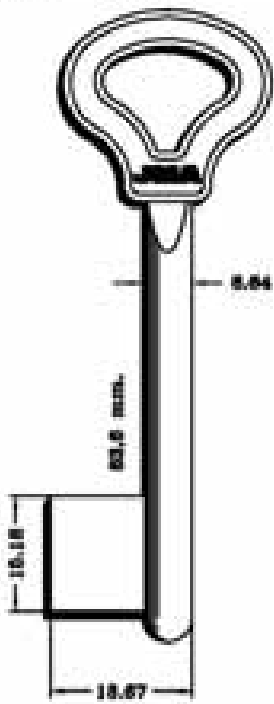

LAR-1G

LÅSBOLAGET

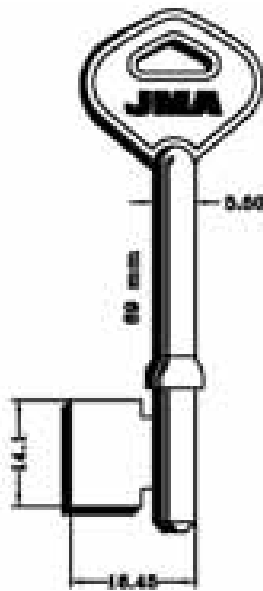

LASB-1G



LASB-2G

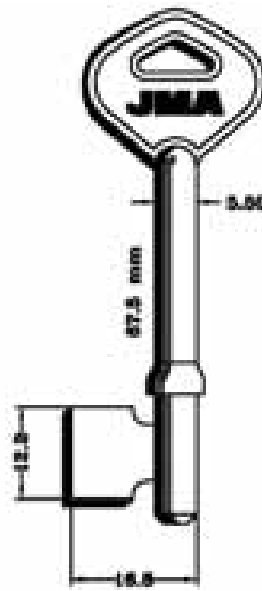

LASB-3G

PARA-FOR:

LAR (E)

LÅSBOLAGET (S)

MCM (E)

MOSKVA (RUS)

PARA-FOR: LÅSBOLAGET

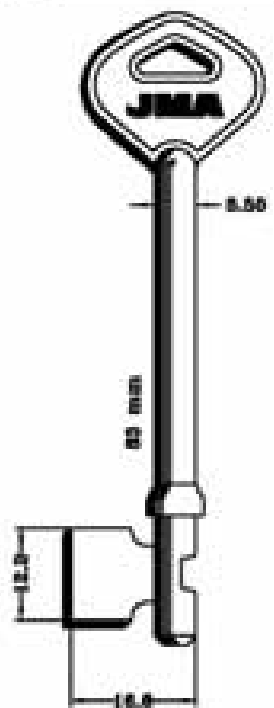

LASB-4G

MCM

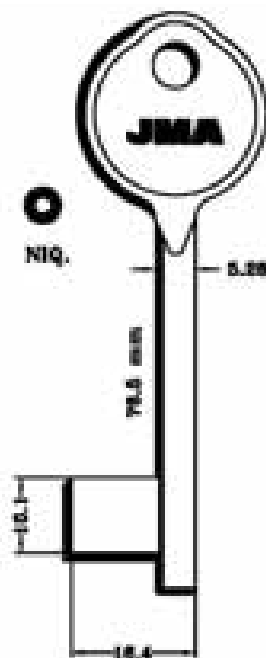

MCM-1G

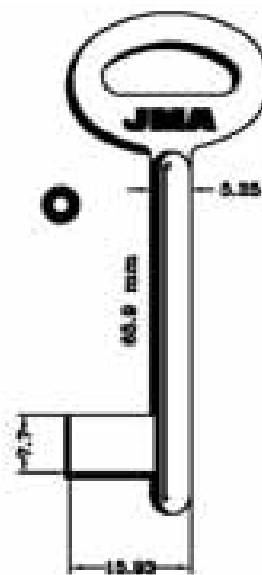

MCM-4G

MOSKVA

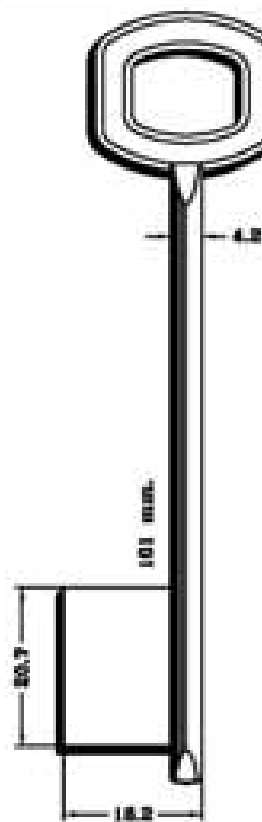

MOK-1G

Copyright by
Alejandro Altamir S.A.
2018

JMA



269

PARA-FOR:

ORENGO (E)

OSTMARK (D)

RENAG (N)

REX (N)

TESA (E)

PARA-FOR:	ORENGO		OSTMARK	
	OR-3G	OR-6G	OST-1G	OST-2G

PARA-FOR:	RENAG	REX		TESA
	REN-1G REN-2G	REX-1G	REX-2G	TE-1G

Copyright by
Alejandro Allina S.A.
2018

JMA



270

PARA:
FOR:

TESA

TRIO-VING

PARA-FOR:

TESA (E)

TRIO-VING
(N)

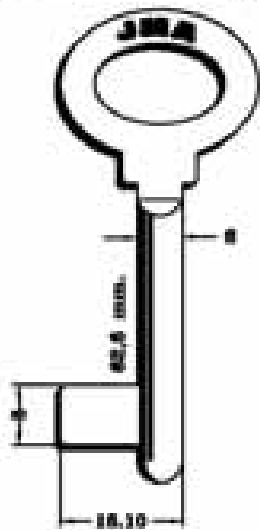

TE-2G

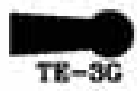
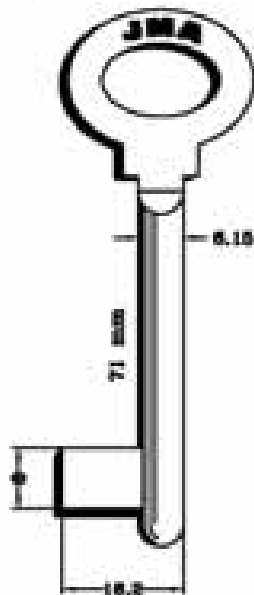

TE-3G

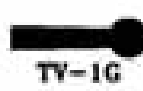
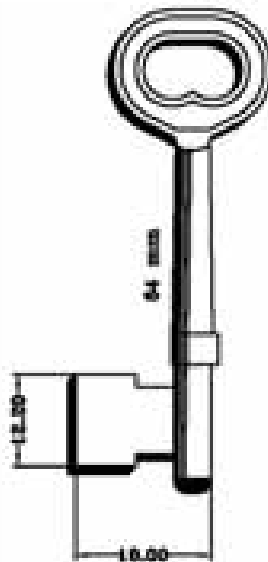

TV-1G

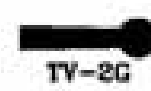

TV-2G

PARA:
FOR:

TRIO-VING

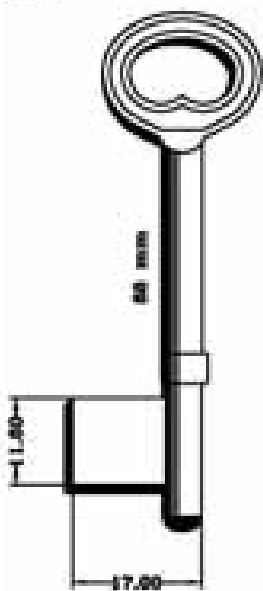

TV-3G

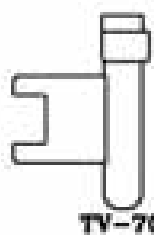

TV-7G

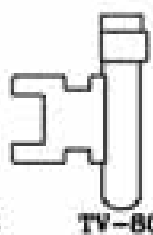

TV-8G

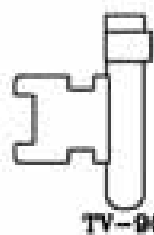

TV-9G

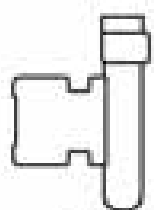

TV-10G

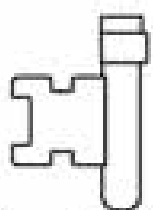

TV-11G

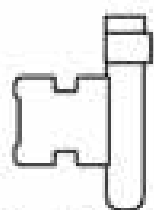

TV-12G

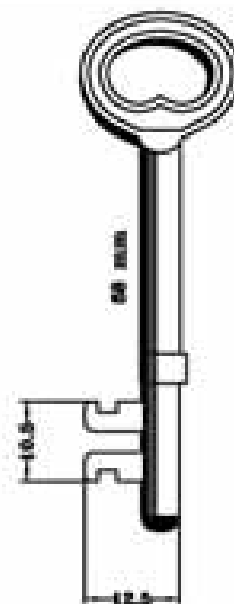

TV-5G

Copyright by
Aljandre Almon S.A.
2010

JMA



271

PARA-FOR:

PARA-FOR:

TRIO-VING

**TRIO-VING
(N)**

UCEM (E)

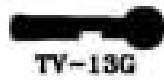
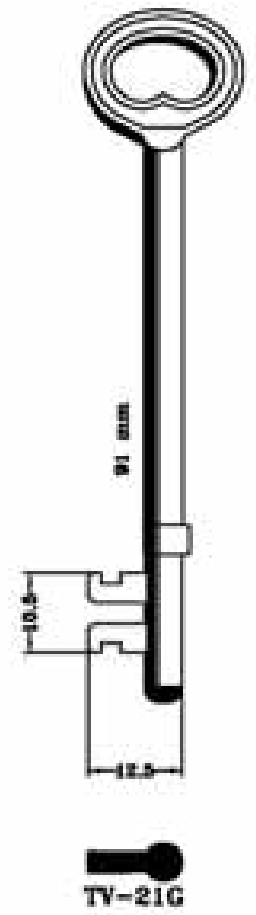
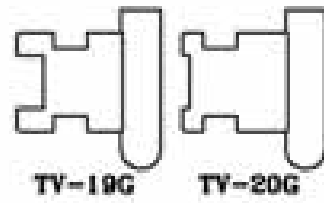
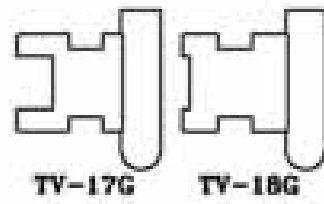
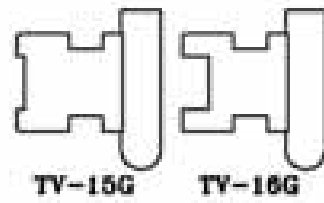
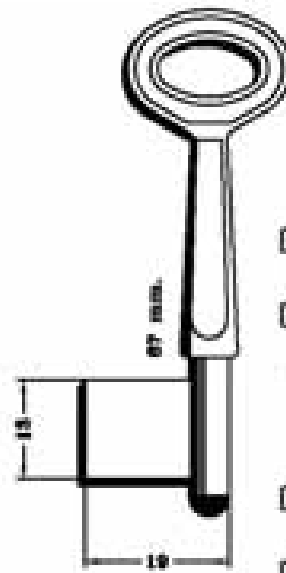
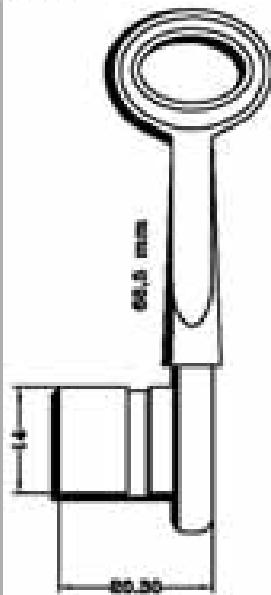

TV-13G

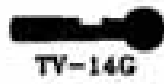

TV-14G



TV-15G

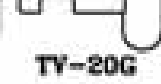

TV-16G



TV-21G

PARA-FOR:

TRIO-VING

UCEM

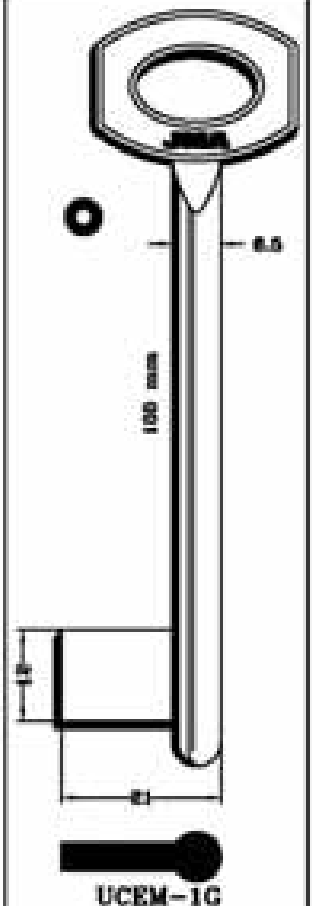
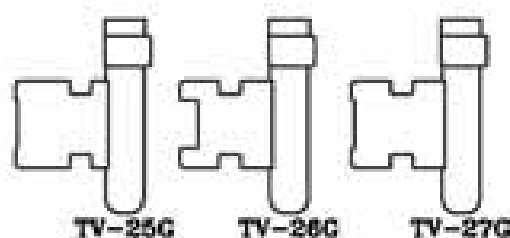
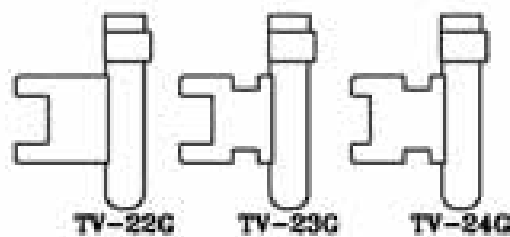
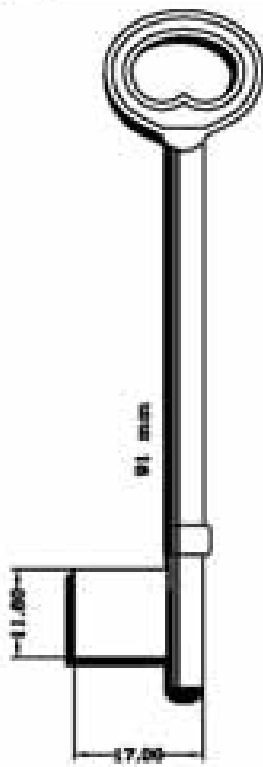



UCEM-1G

Copyright by
Alejandro Allier S.A.
2018

JMA

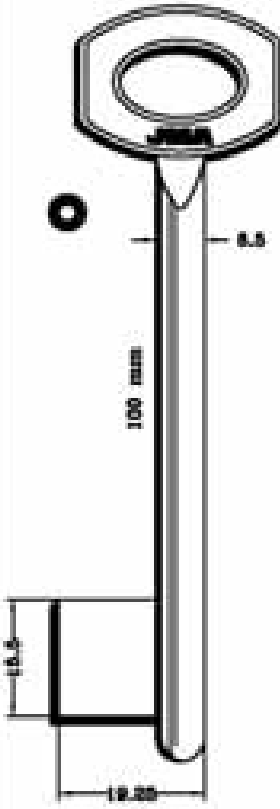

272

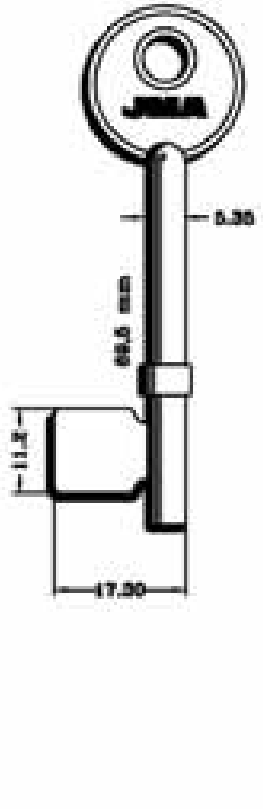
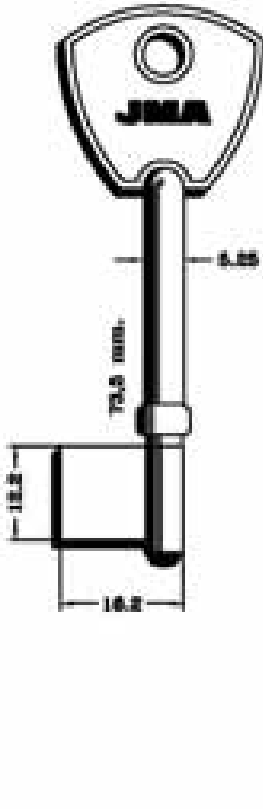
PARA-FOR:	UCEM	UNION	WMS	PARA-FOR:
 <p>UCEM-2G</p>	 <p>UCEM-3G</p>	 <p>UN-1G</p>	 <p>WM-1G</p>	<p>UCEM (E) UNION (GB) WMS (GB) YALE (GB)</p>

PARA-FOR: YALE

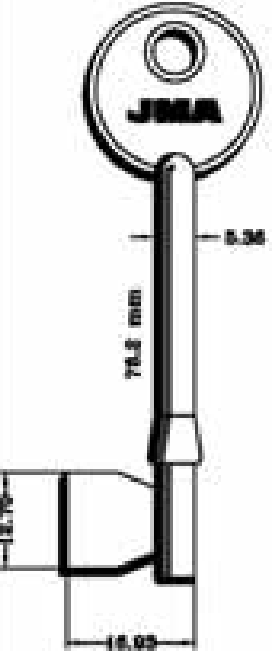

YA-5G

Copyright by
Aljandre Almon S.A.
2018

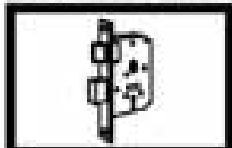
273

PARA-FOR:

AKARSAN (TR)

ANTONIOLI (I)

ASSA (S)

ATRA (I)

PARA-FOR: AKARSAN

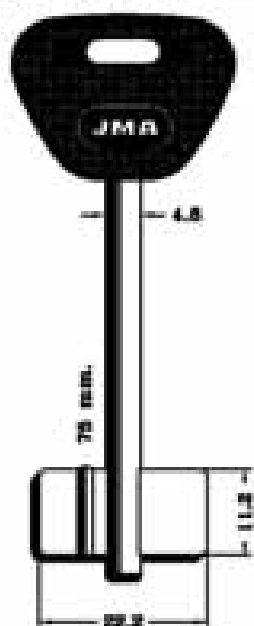

AKA-1PG

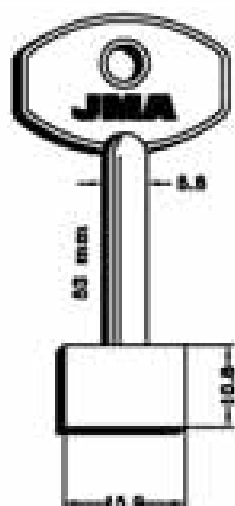

ANT-1G

ANTONIOLI

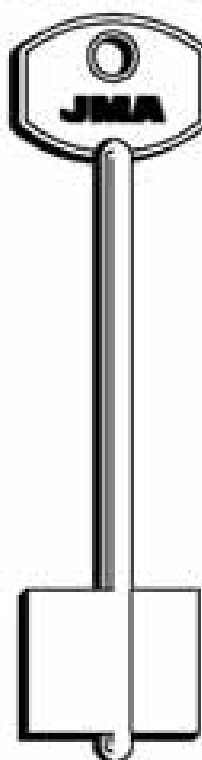

ANT-2G

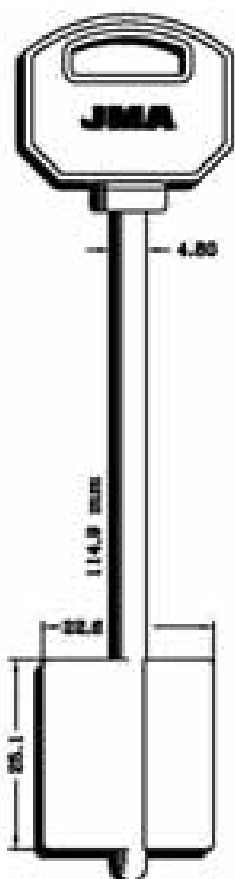

ANT-3G

PARA-FOR:

ANTONIOLI

ASSA

ATRA

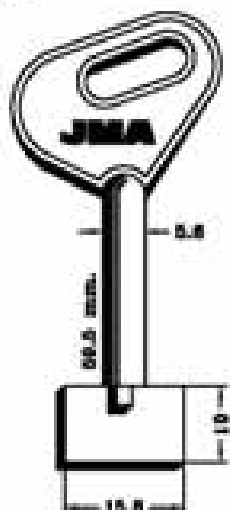

ANT-4G
AUNO

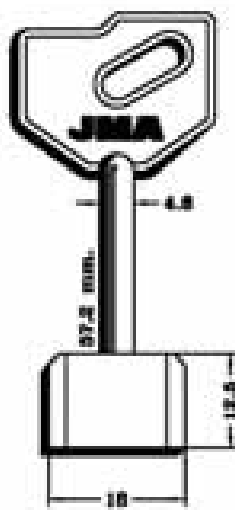

ANT-5G
AUNO

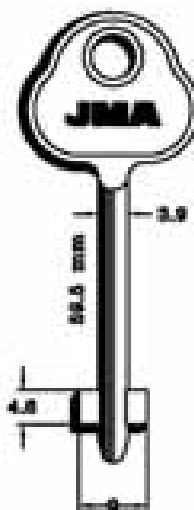

AS-4G

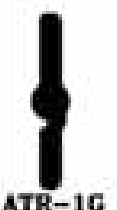
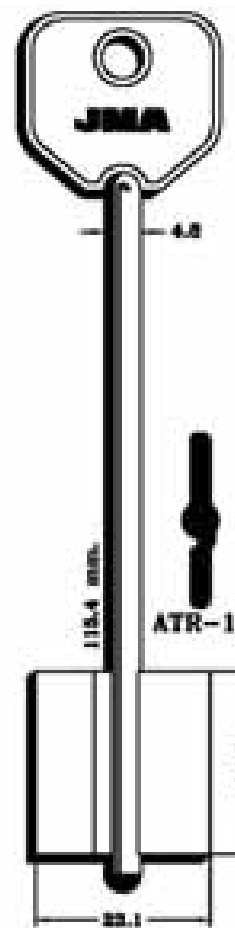

ATR-1G

Copyright by
Algodoro Altime S.A.
2018

JMA

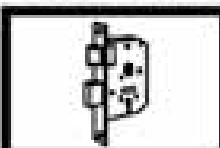

274

PARA:
FOR:

ATRA

BETA

PARA-FOR:

ATRA (I)

BETA (I)

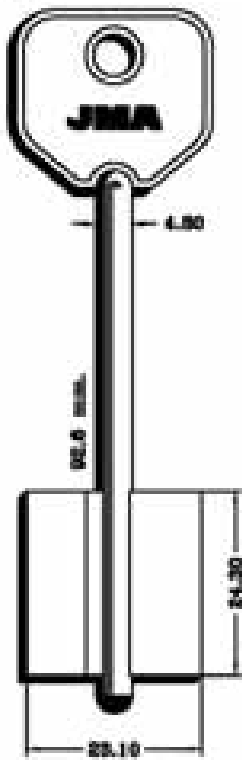

ATR-2G

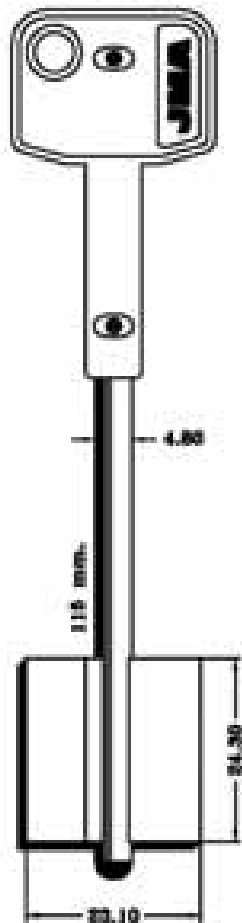

ATR-2TG

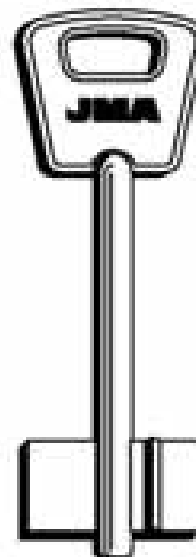

BE-1G

PARA:
FOR:

BETA

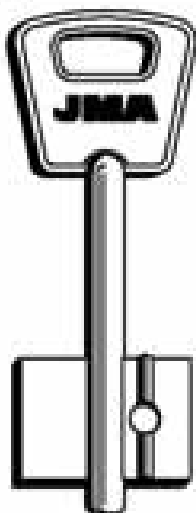

BE-3G



BE-4G

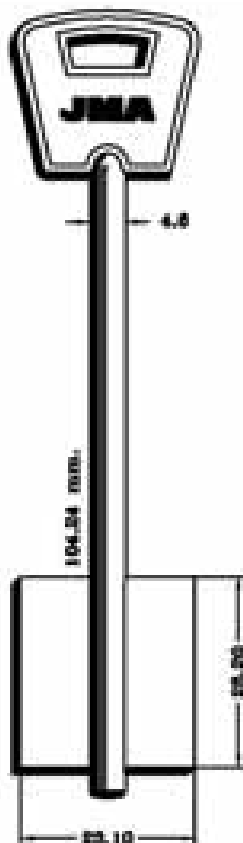

BE-5G



BE-6G

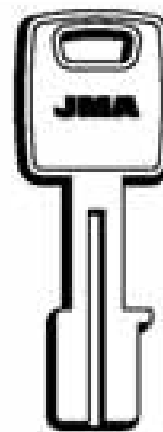

BE-7G

Copyright by
Alejandro Altamir S.A.
2010

JMA



275

PARA-FOR:

- BETA (I)**
- BMC (I)**
- BODA (SF)**
- BOGATIR (RUS)**
- BOXAFE (I)**

PARA-FOR:	BETA	BMC	BODA	
	<p>BE-10G</p>	<p>BMC-1G</p>	<p>BOD-1G</p>	<p>BOD-2G</p>

PARA-FOR:	BODA	BOGATIR		BOXAFE
	<p>BOD-3G</p>	<p>BOG-1G</p>	<p>BOG-2G</p>	<p>BOX-1G</p>

Copyright by
Allegre Allmax S.A.
2018

JMA



276

PARA:
FOR:

CAF

CERUTTI

PARA-FOR:

CAF (I)

CERUTTI (I)

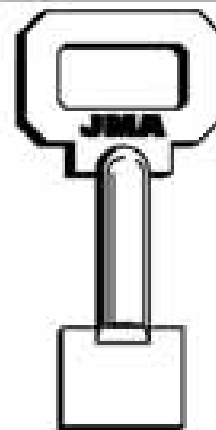
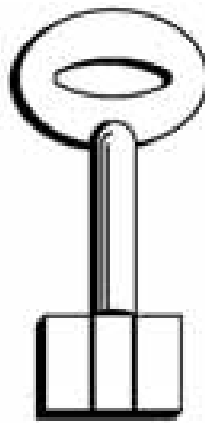
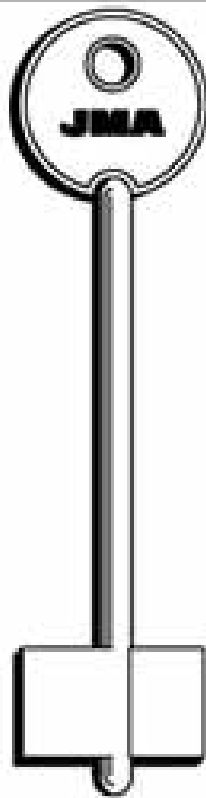
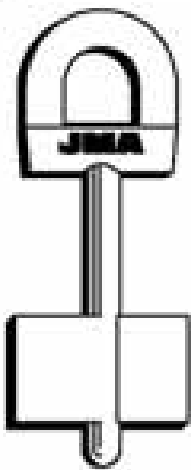

CAF-1G



CAF-2G



CRT-1G



CRT-2G

PARA:
FOR:

CERUTTI

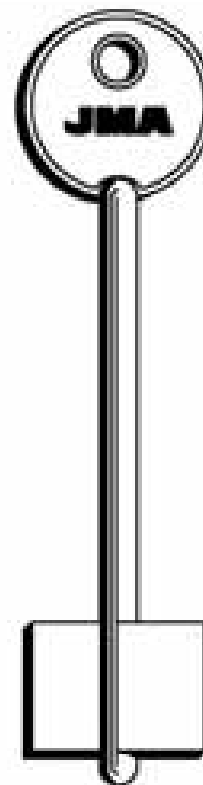
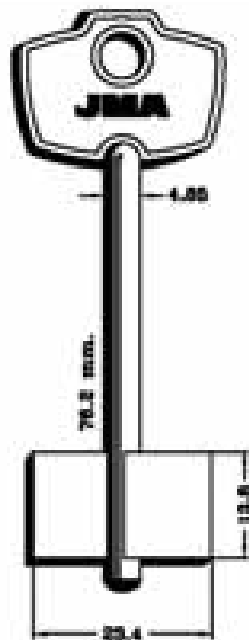
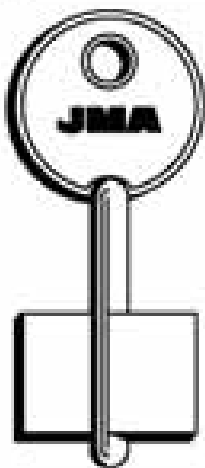

CRT-3G



CRT-4G



CRT-7G



CRT-8G

Copyright by
Alejandro Altamir S.A.
2010

JMA



277

PARA-FOR:

CERUTTI (I)

CHUBB (GB)

PARA-FOR:

CERUTTI

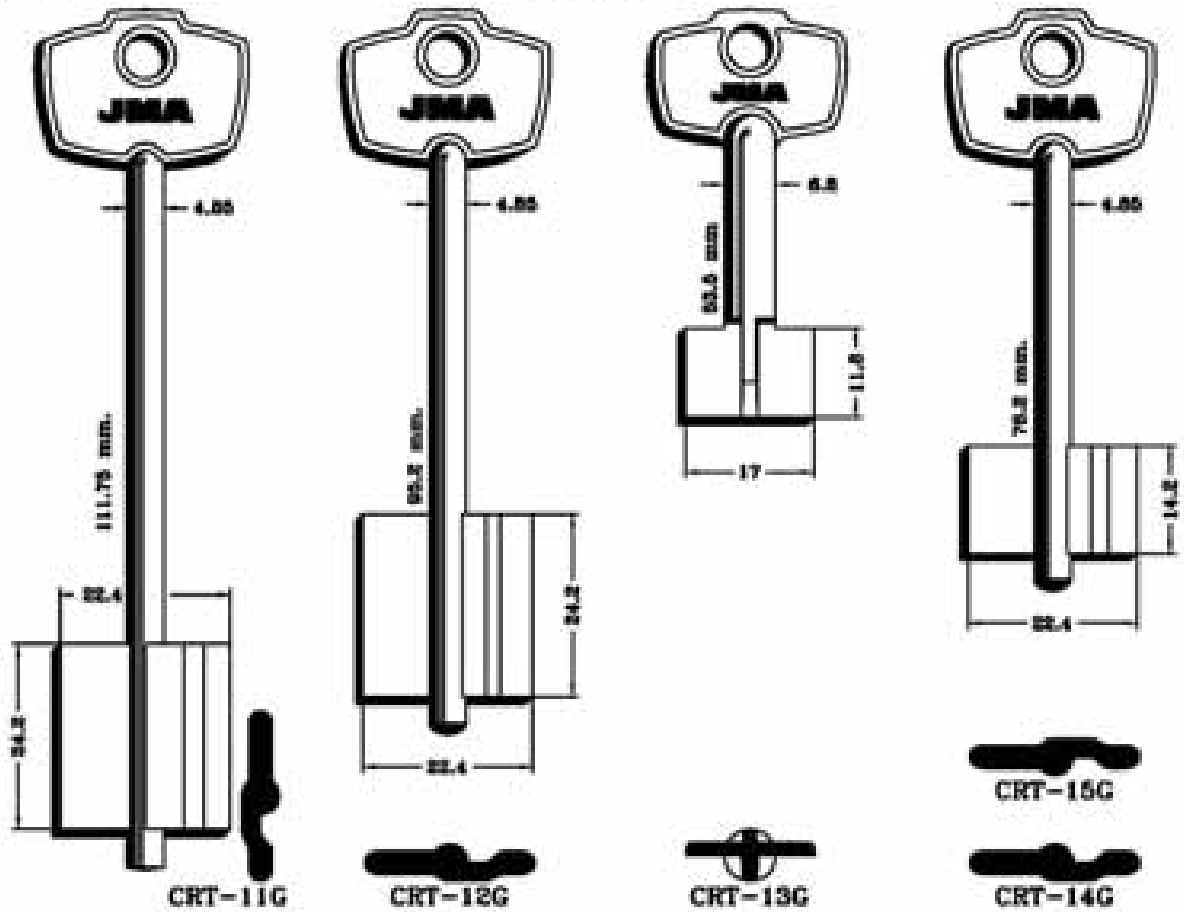

PARA-FOR:

CERUTTI

CHUBB

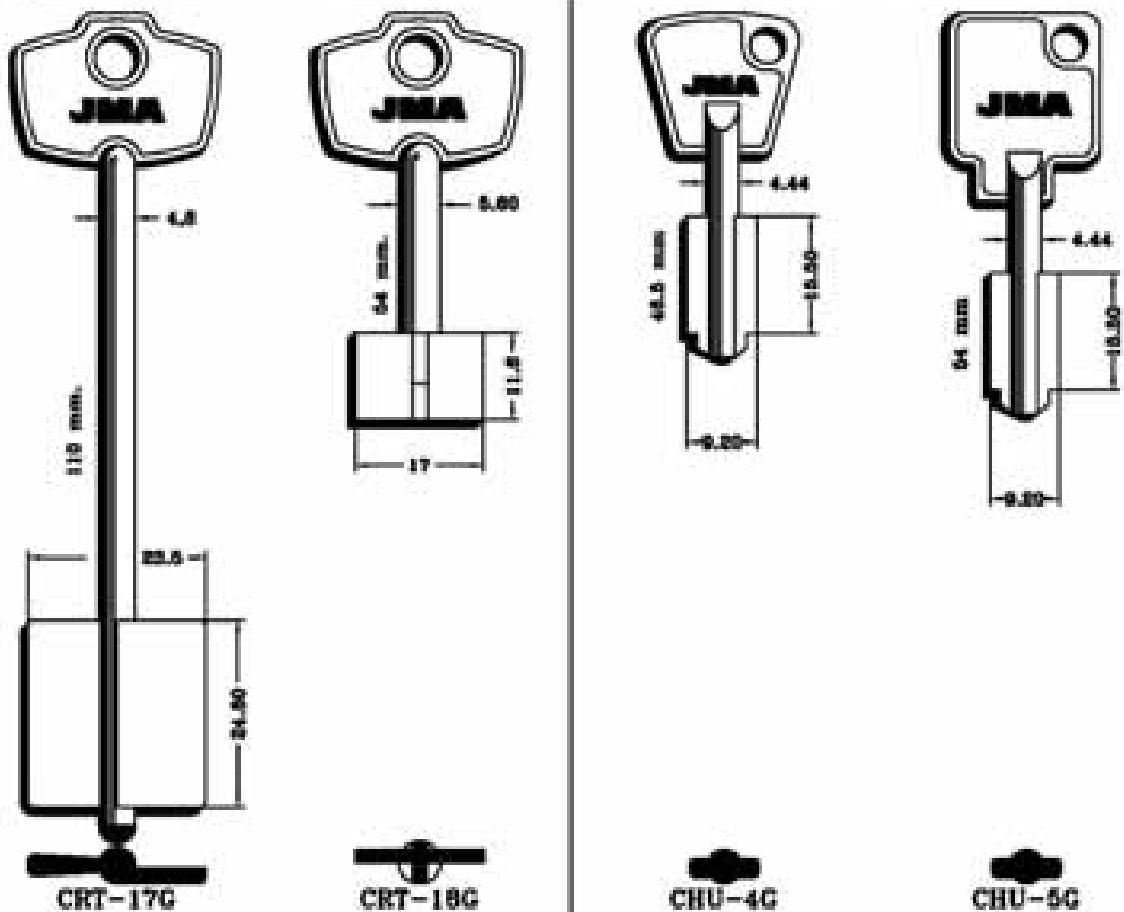

Copyright by
Algodora Alltina S.A.
2018

JMA



278

PARA:
FOR:

CISA

PARA-FOR:

CISA (I)

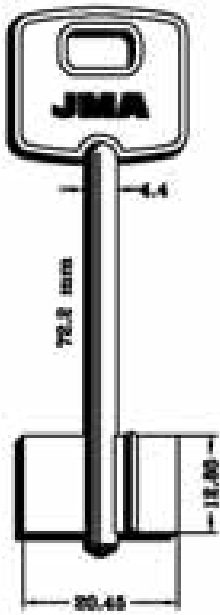

CI-1G

CI-2G

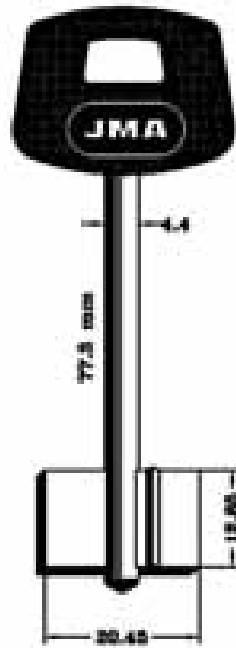

CI-1PG

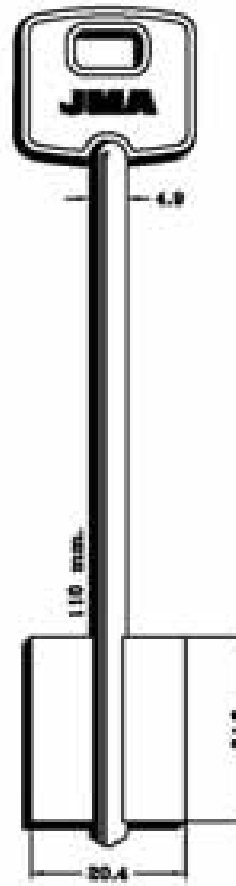

CI-3G

CI-4G

PARA:
FOR:

CISA

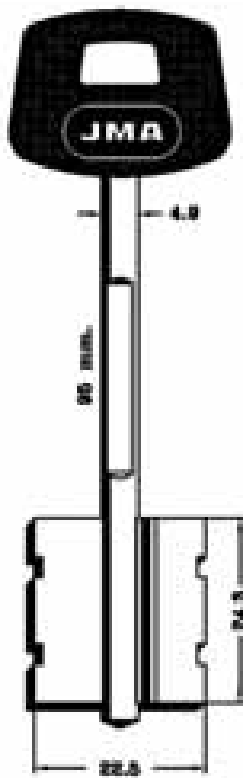

CI-5PG

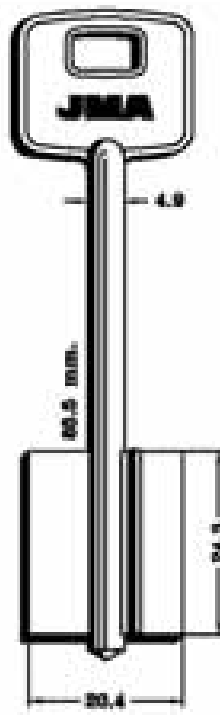

CI-6G

CI-10G

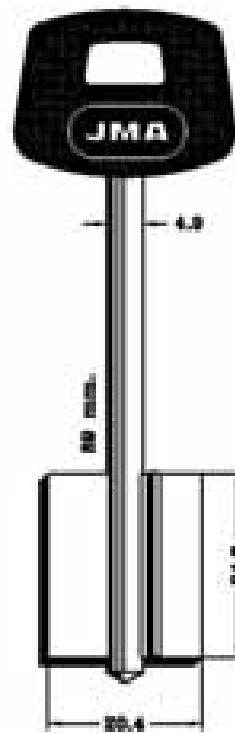

CI-8PG

Copyright by
Aljeandre Almon S.A.
2010

JMA



279

PARA-FOR:

PARA FOR:

CISA

CISA (I)
CLASS (RUS)
CORBIN (I)

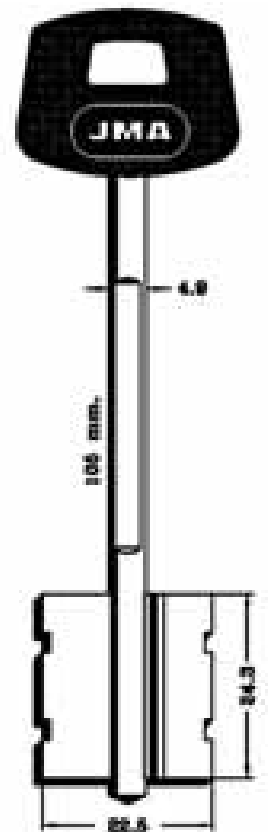
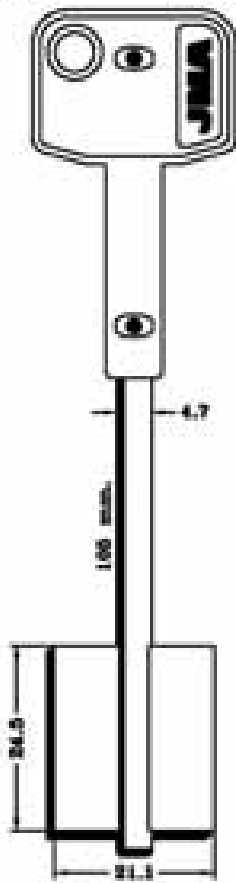

PARA FOR:

CISA

CLASS

CORBIN

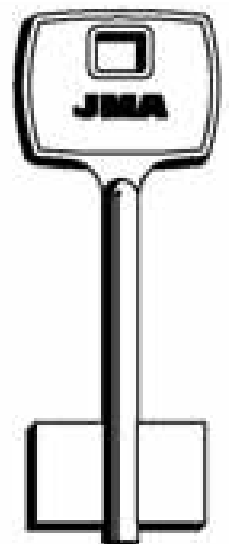
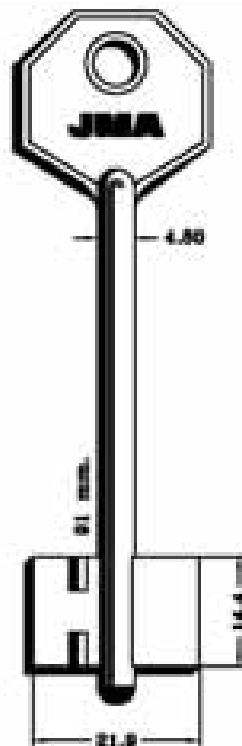
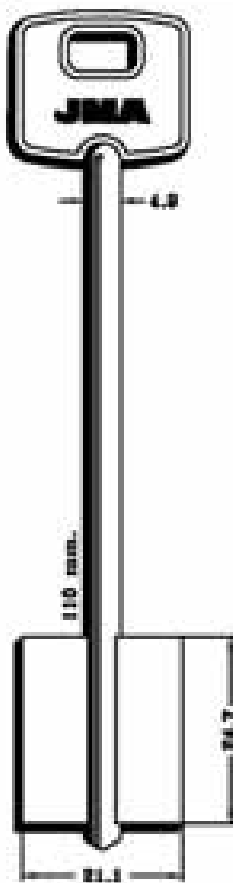

Copyright by
 Alejandro Allina S.A.
 2018

JMA

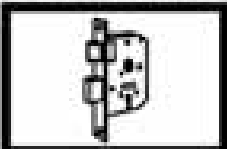

280

PARA:
FOR: CORNI

CR

PARA-FOR:

CORNI (I)

CR (I)

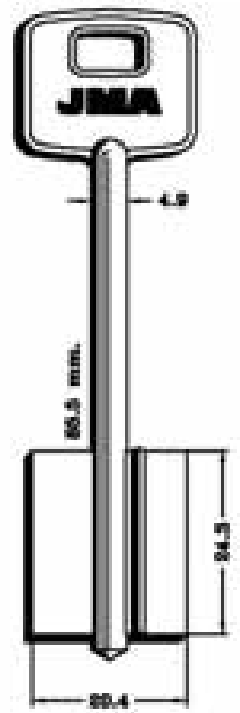

CRN-1G

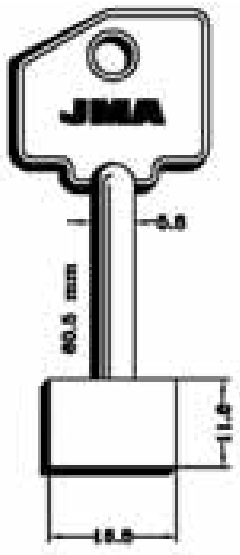

CR-1G

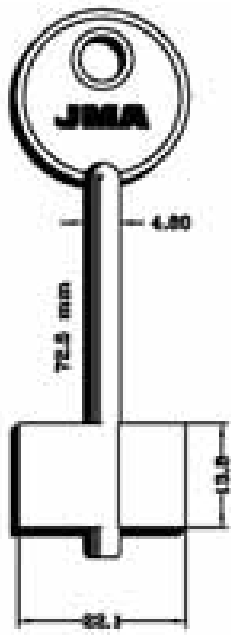

CR-2G

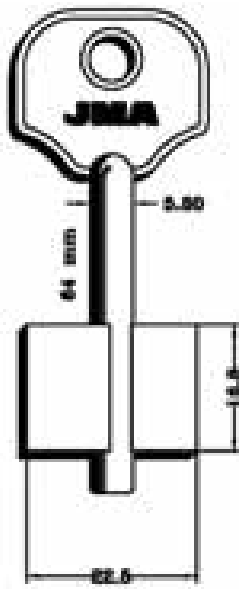

CR-3G

PARA:
FOR:

CR

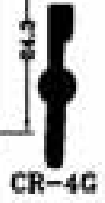
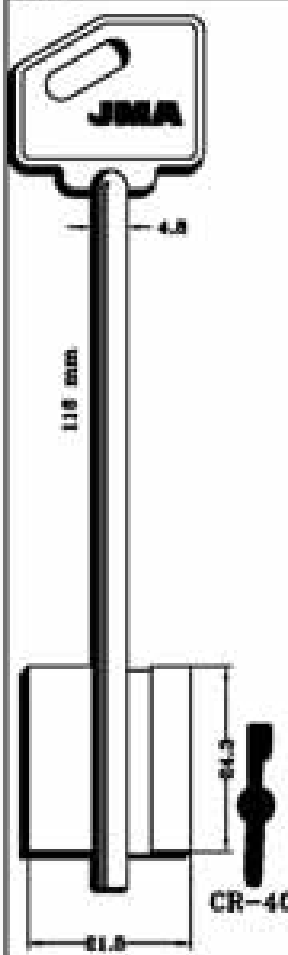

CR-4G

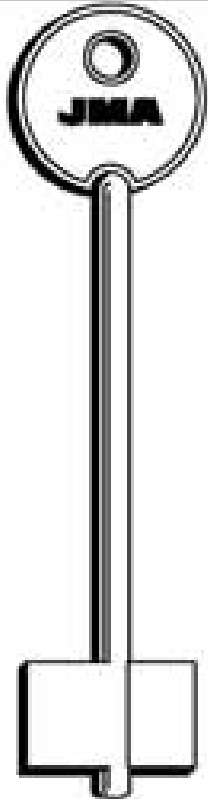

CR-5G



CR-6G

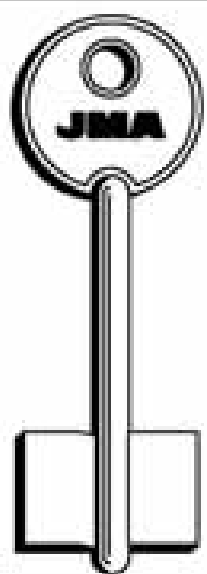

CR-10G

Copyright by
Alejandro Allier S.A.
2019

JMA

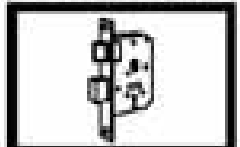

281

PARA-FOR:

PARA FOR:

CR (I)

DEKABA (BG)

CR

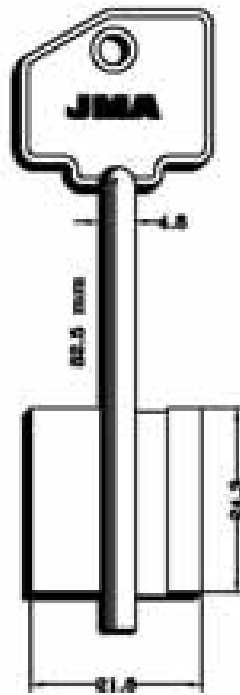

CR-11G

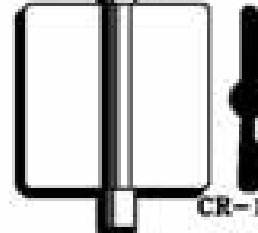
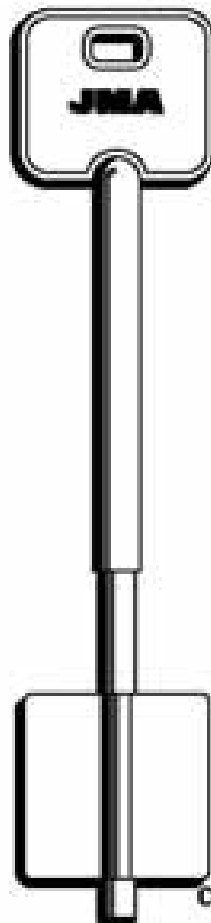

CR-12G

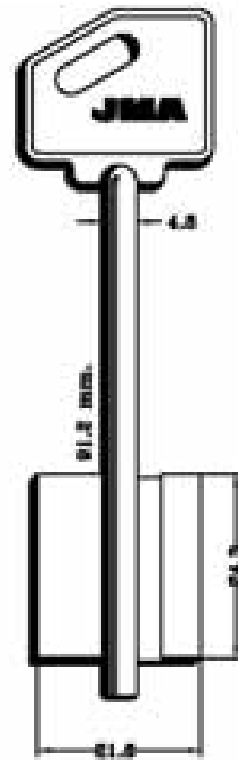

CR-14G

PARA FOR:

CR

DEKABA

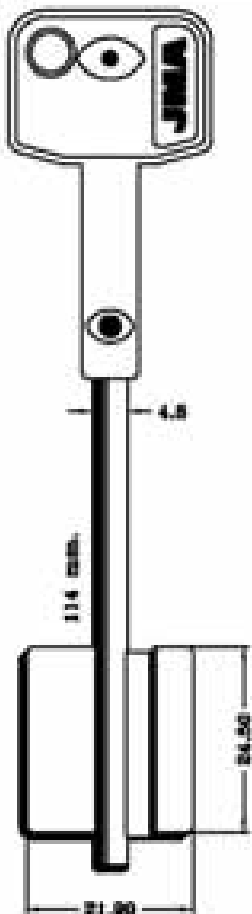

CR-17TG

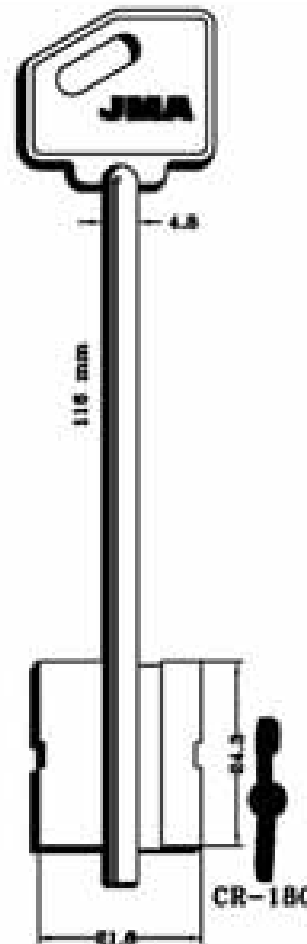

CR-18G

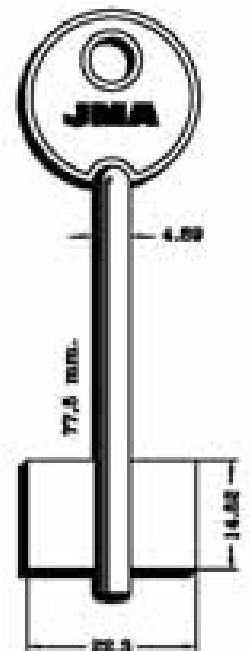

DEK-1G

Copyright by
Alpexsa Allmax S.A.
2018

JMA

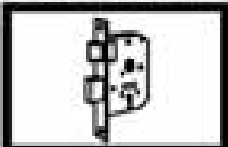

282

PARA:
FOR:

DVERNIAK

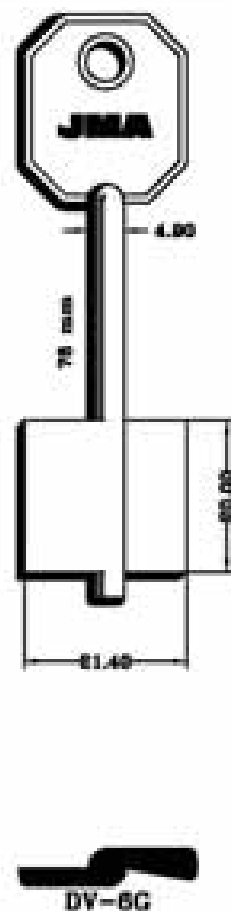
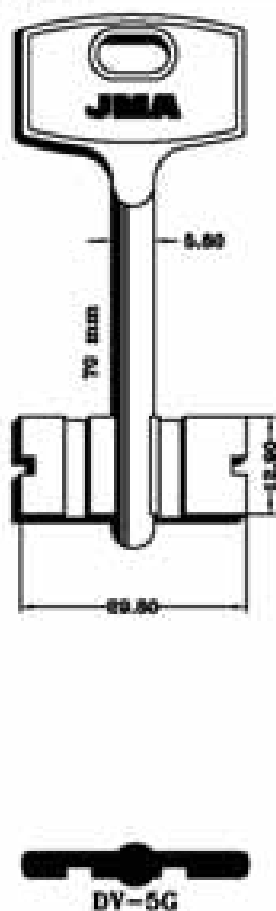
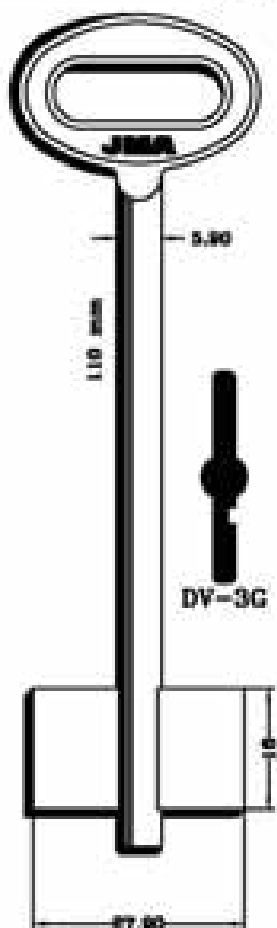
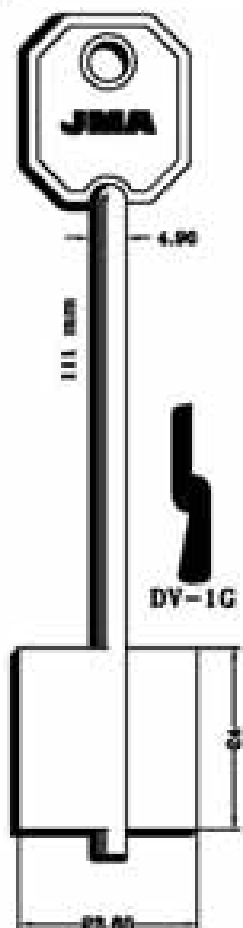

PARA-FOR:

DVERNIAK
(RUS)

PARA:
FOR:

DVERNIAK

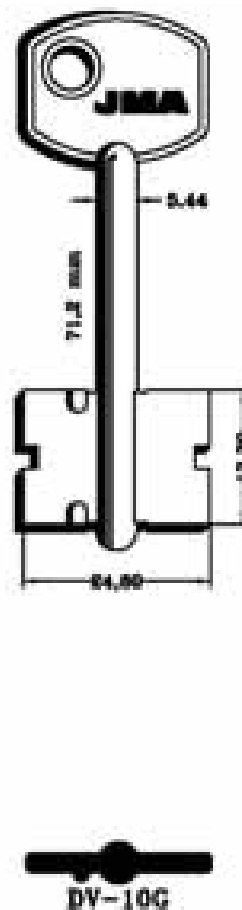
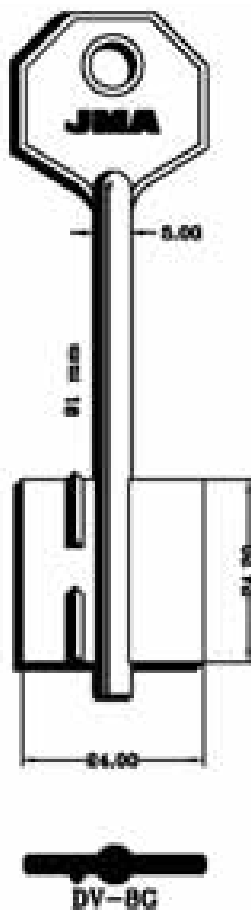
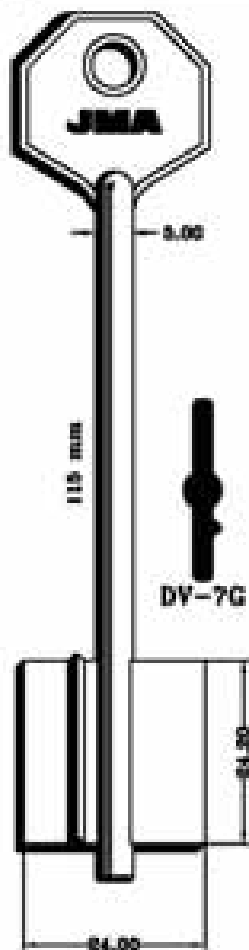

Copyright by
Alejandro Altman S.A.
2010

JMA



283

PARA-FOR:

**DVERNIAK
(RUS)**

ELBOR (RUS)

ELZETT (H)

PARA-FOR:

DVERNIAK

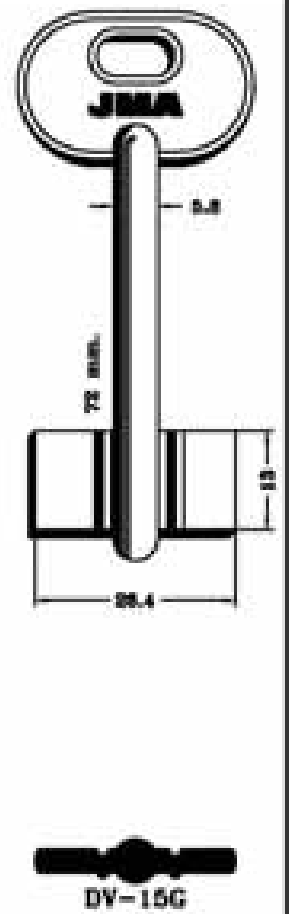
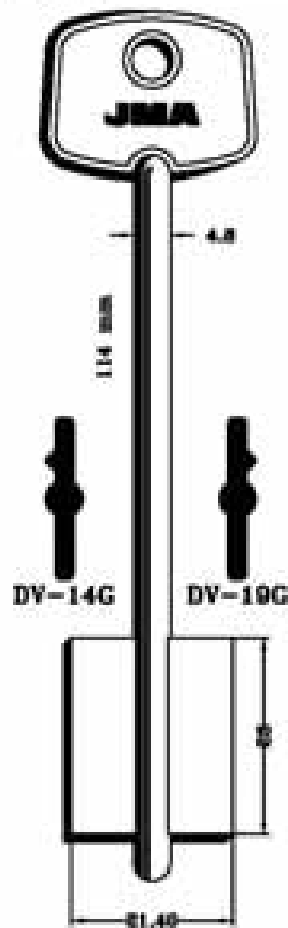
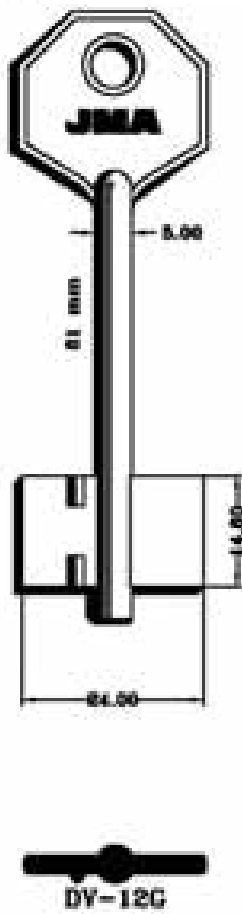

PARA-FOR:

DVERNIAK

ELBOR

ELZETT

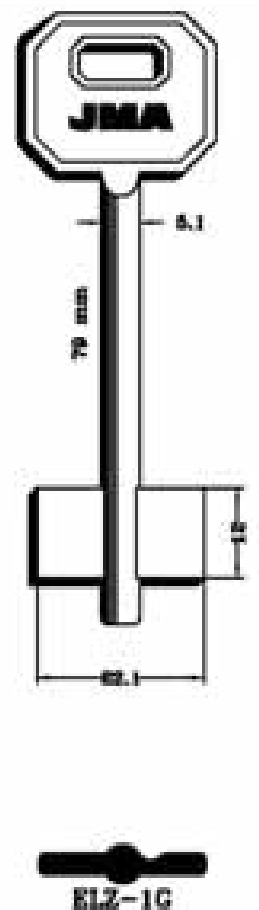
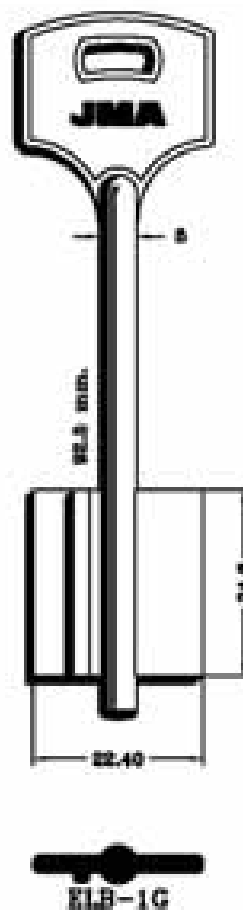
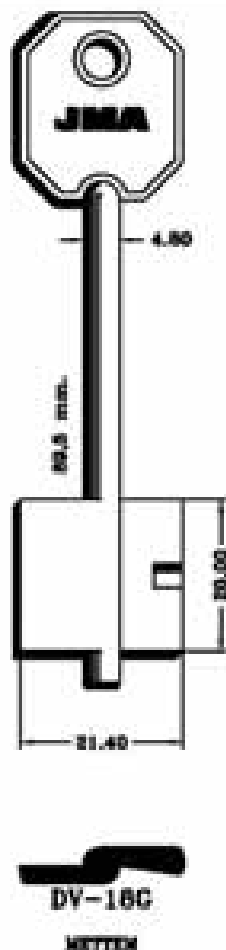
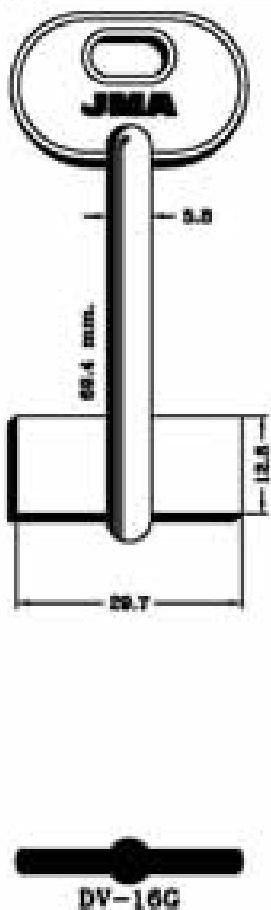

Copyright by
Alquadró Altimis S.A.
1818

JMA



284

PARA:
FOR:

ELZETT

EREVAN

PARA-FOR:

ELZETT (H)

EREVAN (RUS)

ESETY (I)

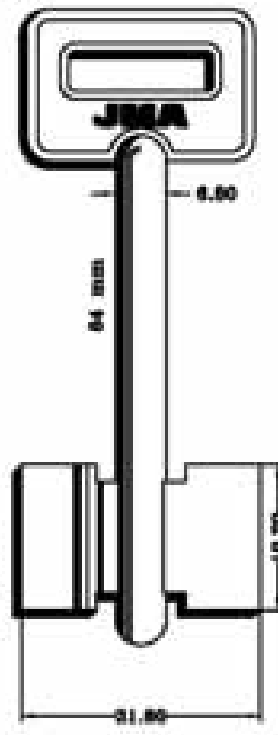
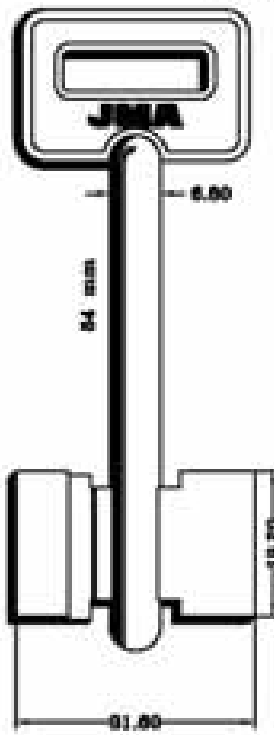
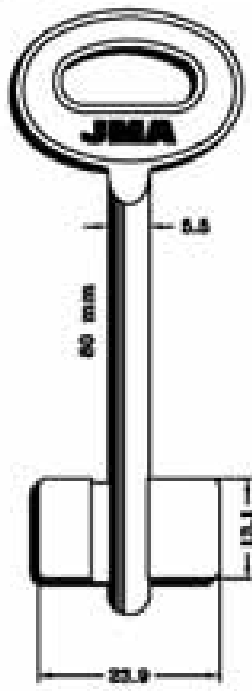
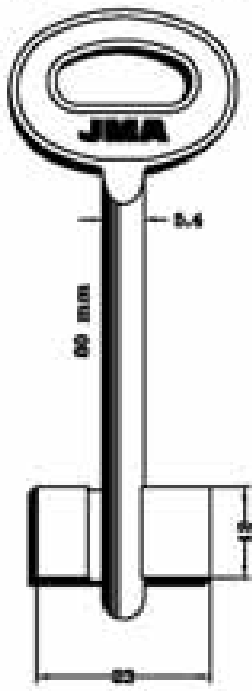

ELZ-4G



ELZ-7G



ERV-1G



ERV-2G

PARA:
FOR:

EREVAN

ESETY

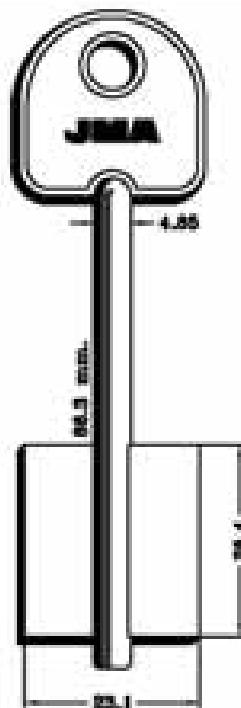
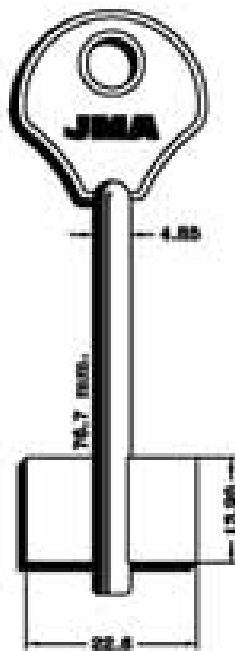
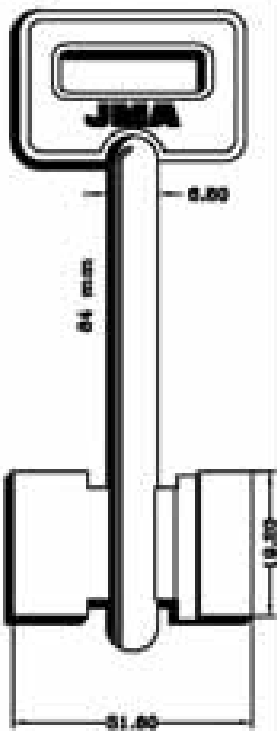

ERV-3G



EST-1G



EST-2G



EST-3G

Copyright by
Alejandro Allmon S.A.
2018

JMA

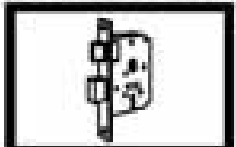

285

PARA-FOR:

ESETY (I)

EUROTEMPLE (I)

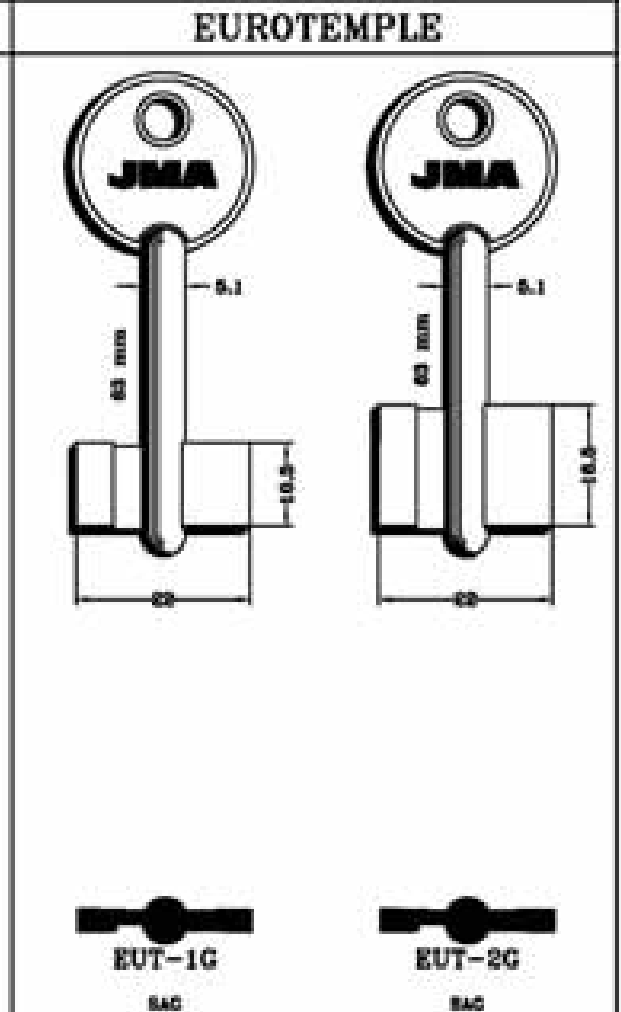
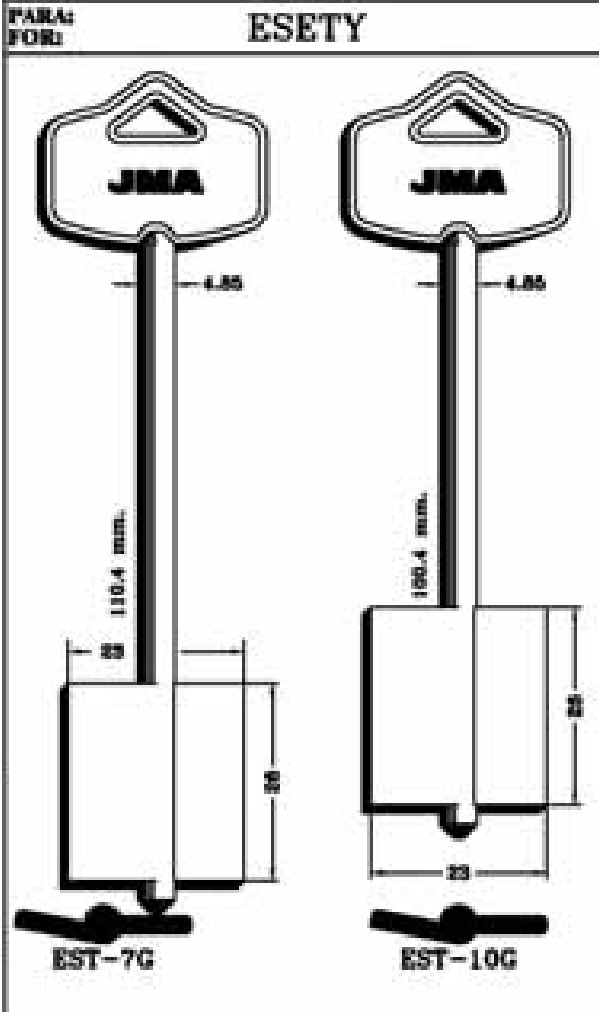
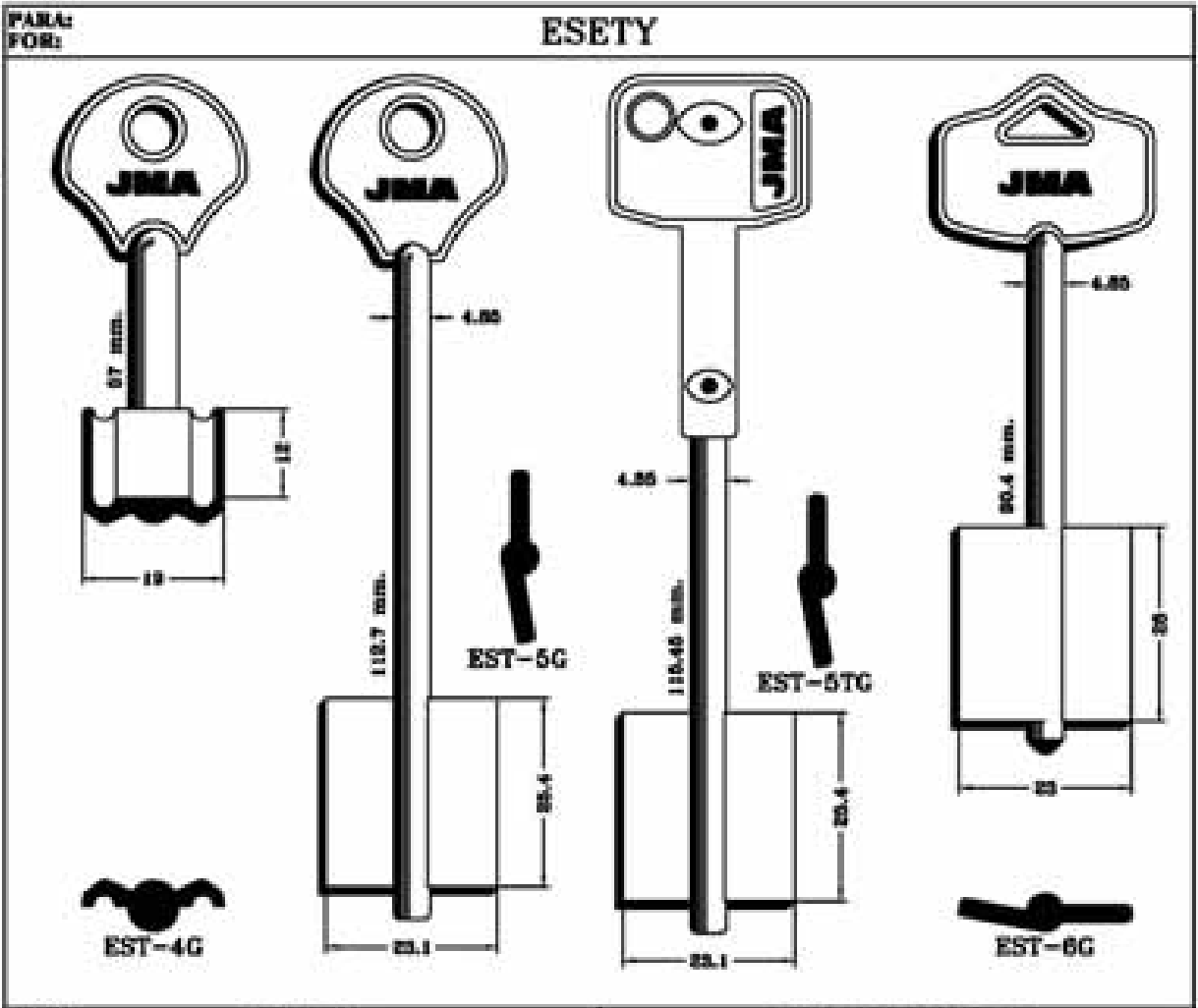

Copyright by
Alfonso Allina S.A.
2018

JMA



286

PARA-FOR: EUROTEMPLE

EZCURRA

PARA-FOR:

EUROTEMPLE (I)

EZCURRA (E)

FAC (E)

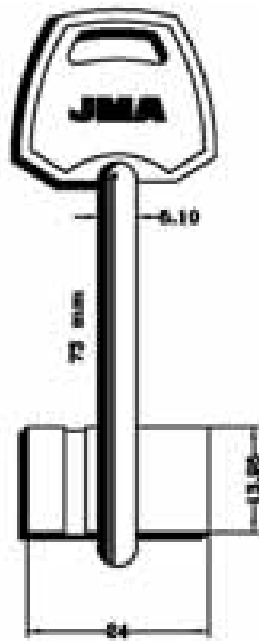
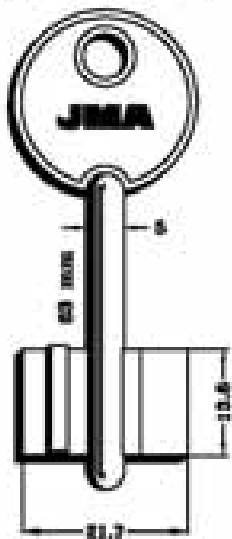

PARA-FOR: EZCURRA

FAC

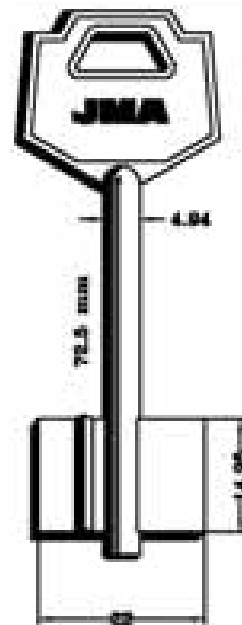
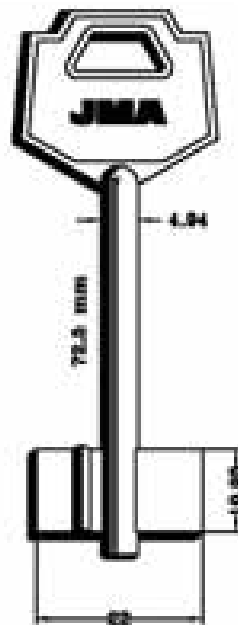
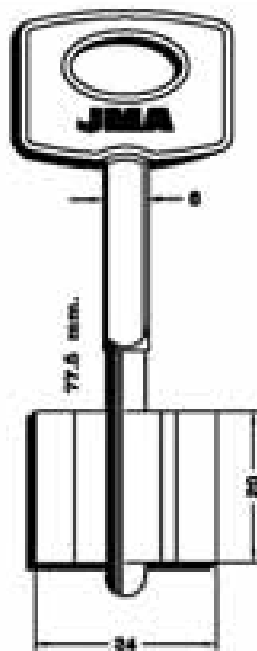
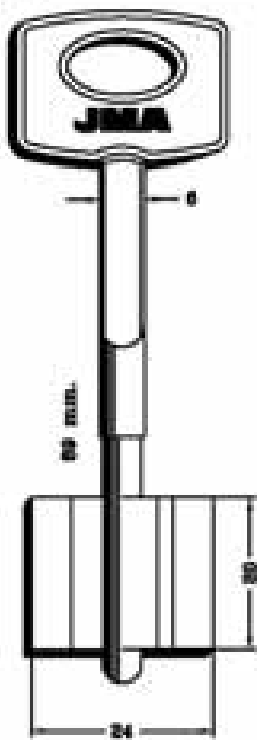

Copyright by
Alejandro Altuna S.A.
2010

JMA



287

PARA-FOR:

- FAC (E)
- FACEF (I)
- FEB (I)
- FETIS (E)
- FIAM (I)

PARA-FOR:	FAC	FACEF	FEB
	<p>FAC-3G</p>	<p>FAC-4G</p>	<p>FCF-1G</p>

PARA-FOR:	FEB	FETIS	FIAM
	<p>FEB-2G</p>	<p>FET-1G</p>	<p>FIAM-1G</p> <p>FIAM-2G</p>

Copyright by
Alpandre Altimis S.A.
1919

JMA



288

PARA:
FOR:

FIAM

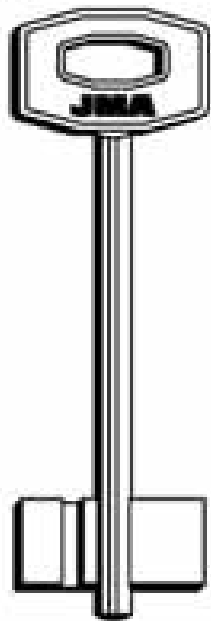

FM-3G

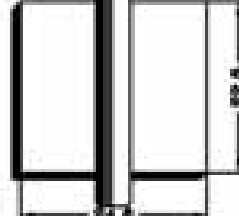
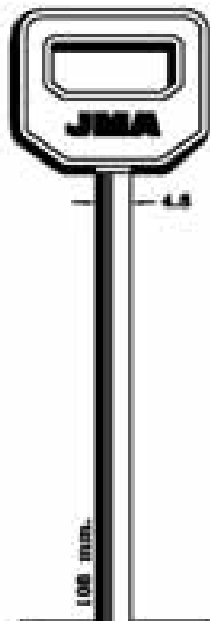

FM-4G

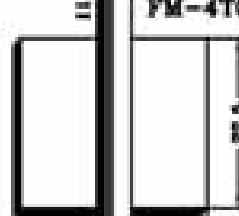
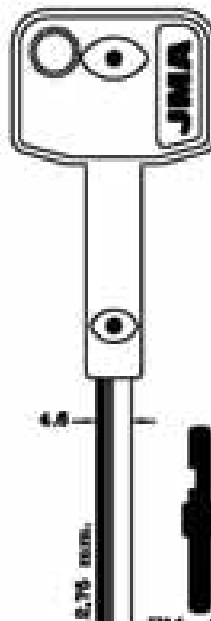

FM-4TC

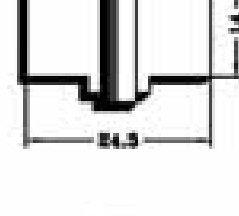
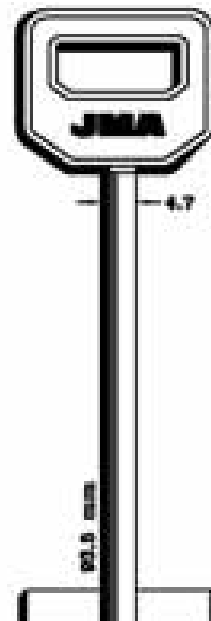

FM-5G

PARA-FOR:

FIAM (I)

PARA:
FOR:

FIAM

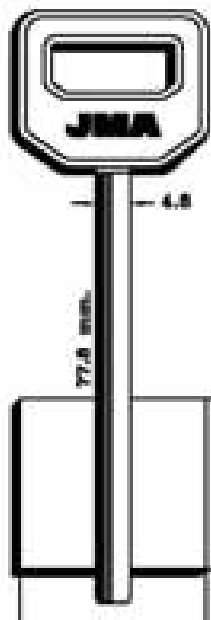

FM-6G

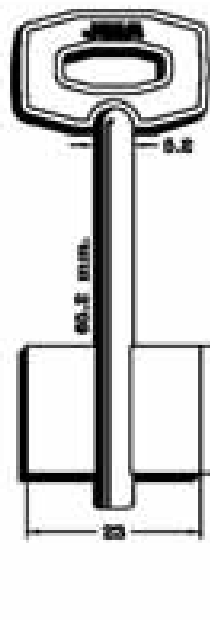

FM-7G

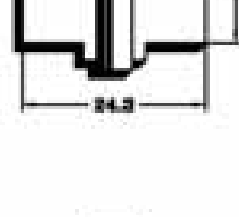
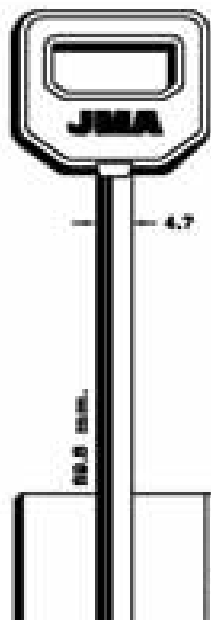

FM-8G

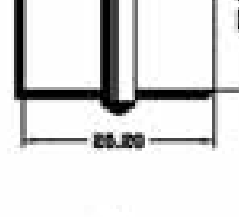

FM-13G

Copyright by
Allegre Altesa S.A.
2018

JMA



289

PARA-FOR:

PARA FOR:

FIAM

- FIAM (I)**
- FICHET (F)**
- GARDIAN (RUS)**

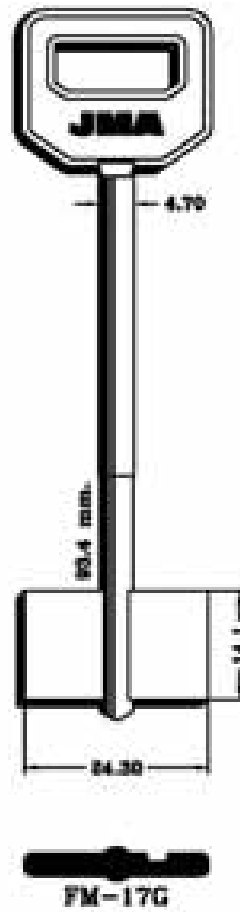
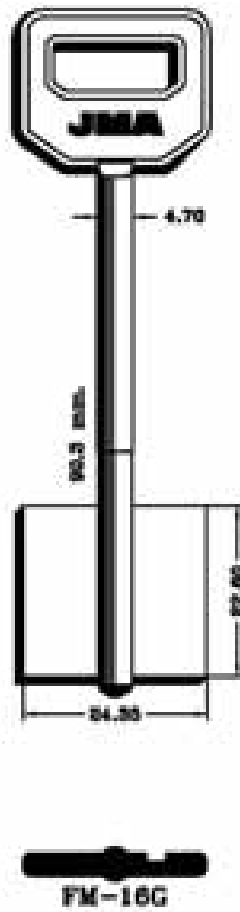
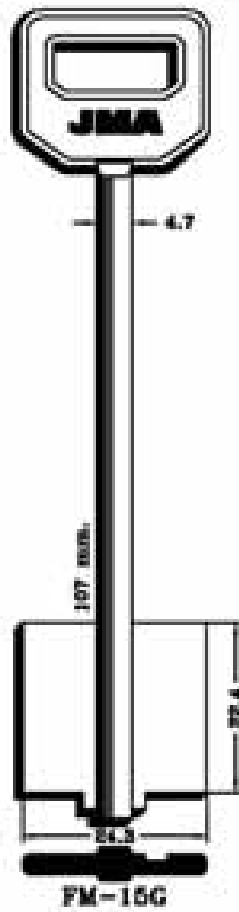
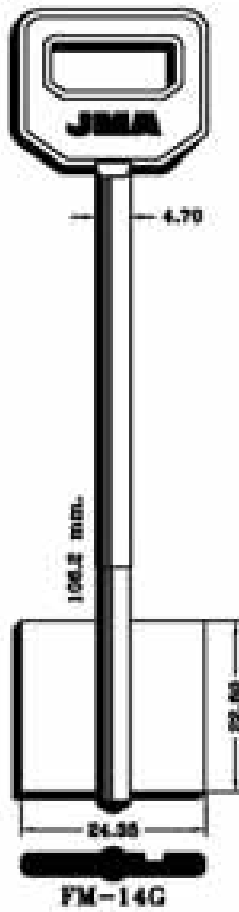

PARA FOR:

FIAM

FICHET

GARDIAN

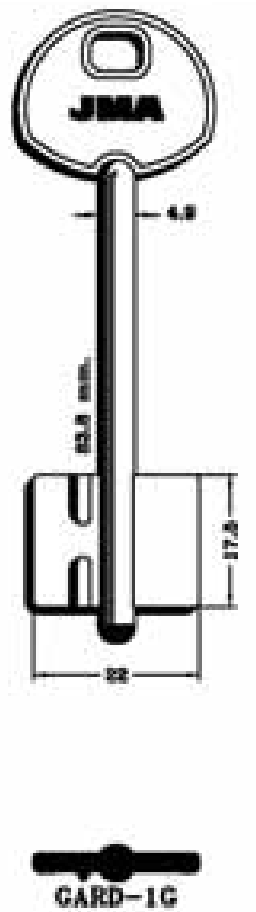
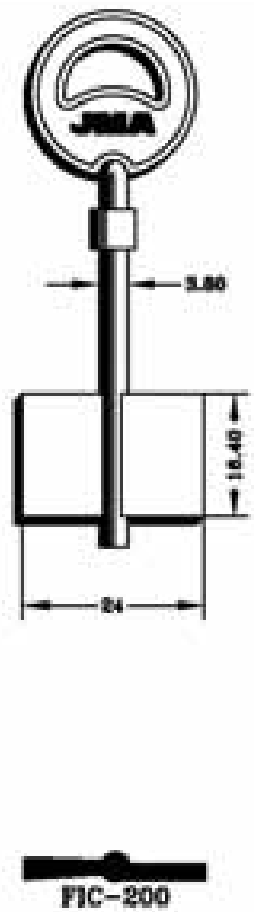
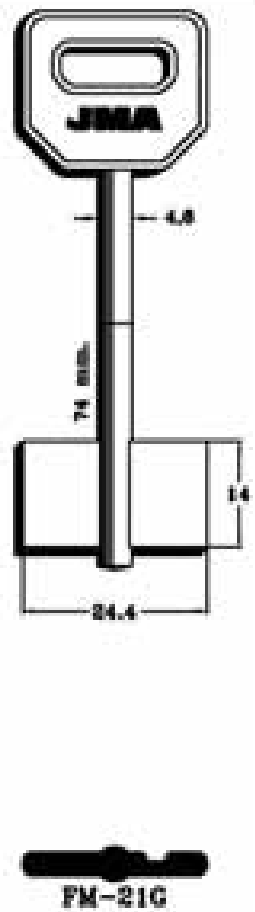
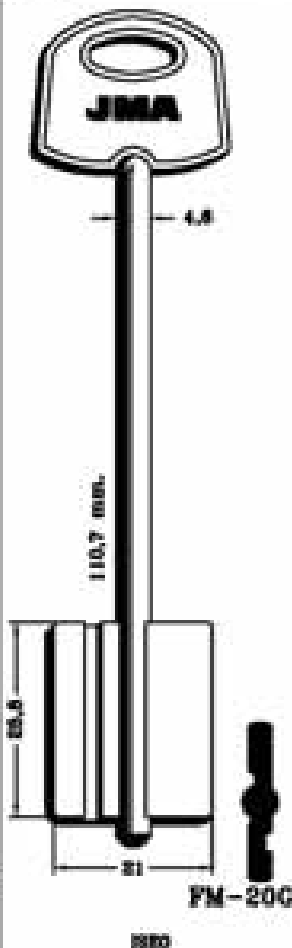

Copyright by
Alejandro Allina S.A.
2018

JMA



290

PARA:
FOR:

GIMAST

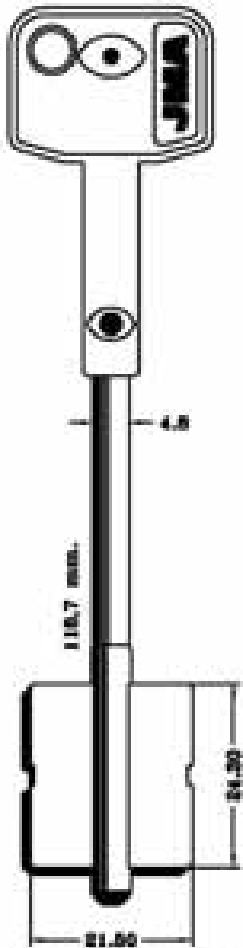

GIM-1TG

GIPIS

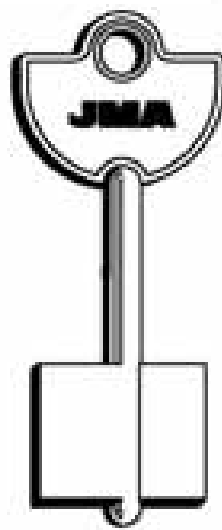

GPS-1G

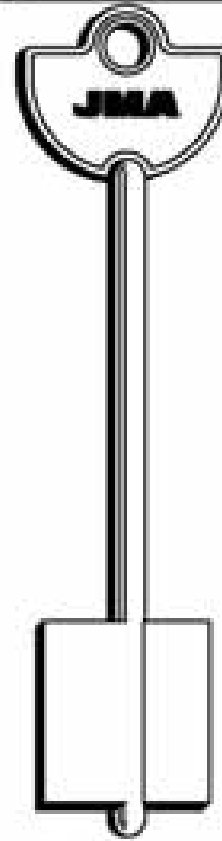

GPS-2G

PARA-FOR:

GIMAST (I)

GIPIS (I)

GMG (I)

IDM (I)

PARA:
FOR:

GMG

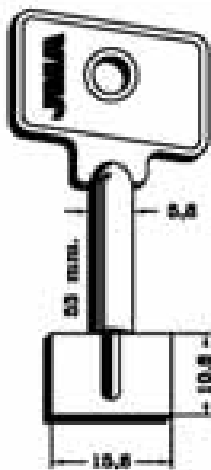

GMG-1G

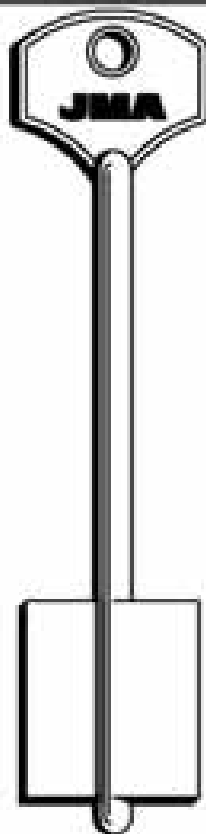

GMG-2G

IDM

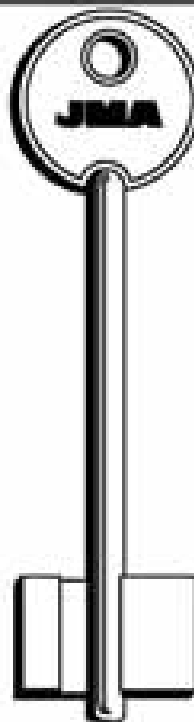

IDM-1G

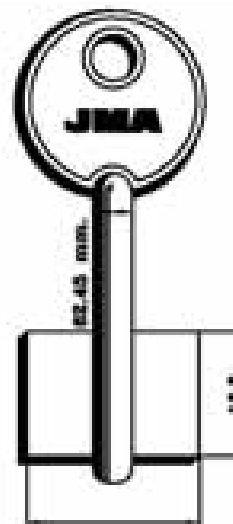

IDM-2G

Copyright by
Alejandro Altamir S.A.
2018

JMA



291

PARA-FOR:

IDM (I)
ISEO (I)

PARA-FOR:	IDM			ISEO
	540		FACE-F-DOMUS	

PARA-FOR:	ISEO			

Copyright by
Alejandro Allina S.A.
2018

JMA

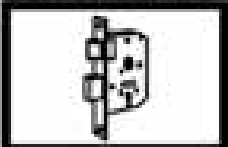

292

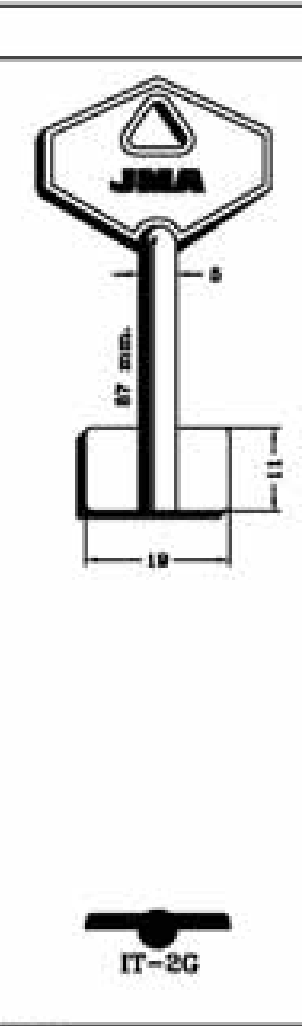
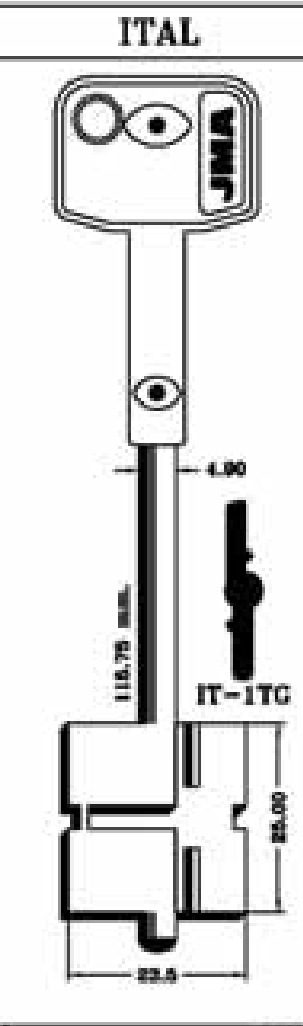
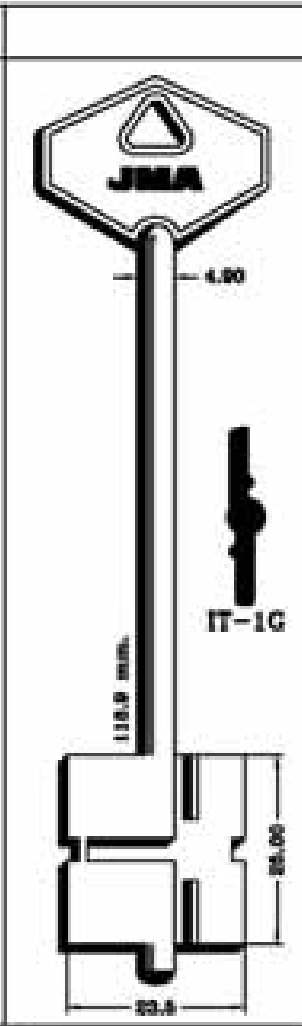
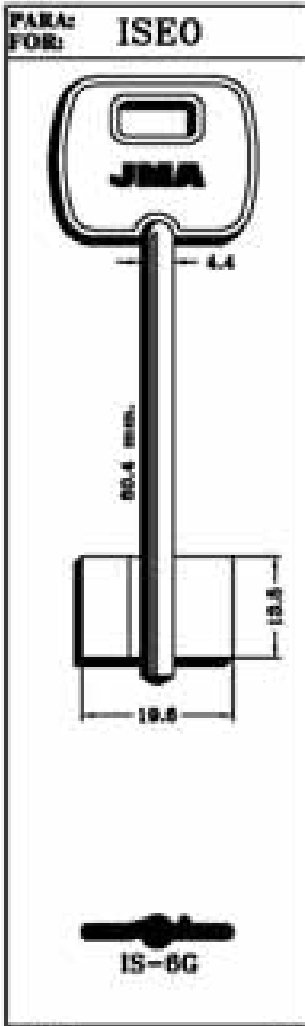

PARA-FOR:
ISEO (I)
ITAL (I)
JUWEL (I)

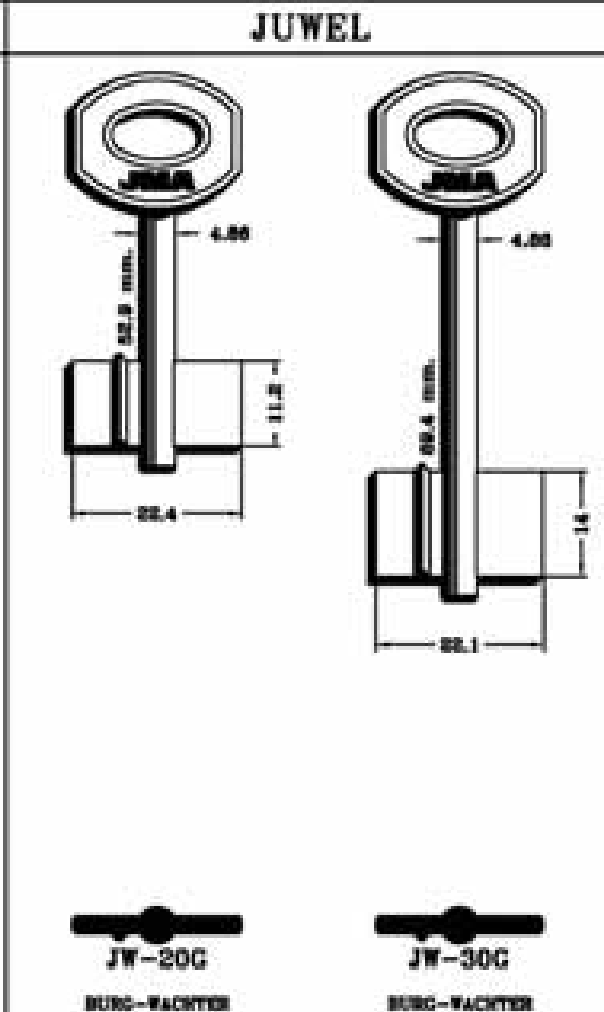
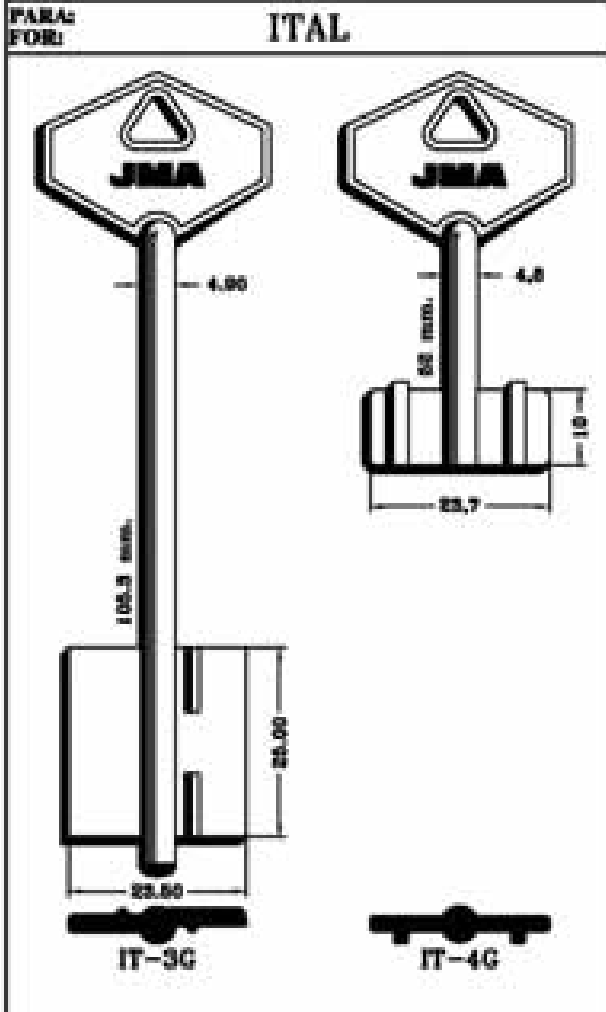

Copyright by
Alejandro Allmar S.A.
2018

293

PARA-FOR:

PARA FOR:

JUWEL

JUWEL (D)

KALE (TR)

KASSEL (D)

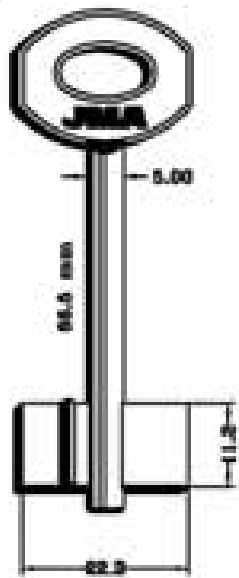

JW-40G
BUNG-FACITER

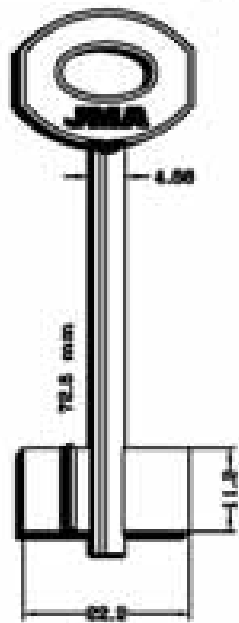

JW-45G
BUNG-FACITER

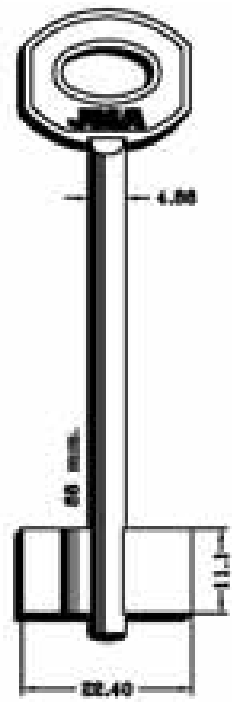

JW-50G



JW-70G
BUNG-FACITER

PARA FOR:

JUWEL

KALE

KASSEL

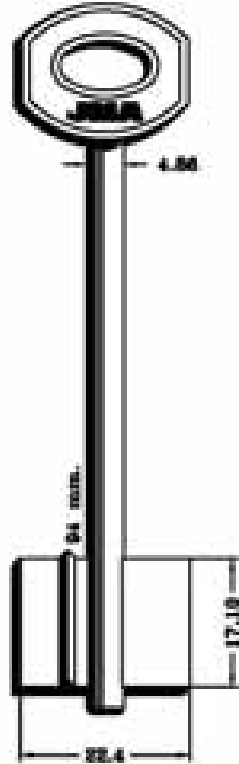

JW-90G

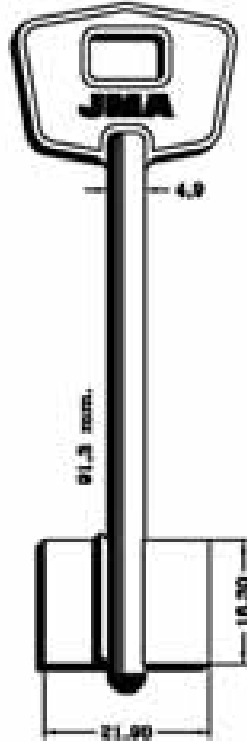

KAB-1G

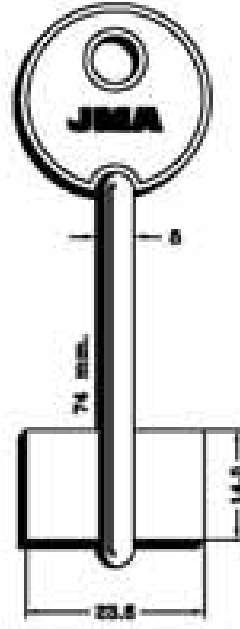

KAS-1G

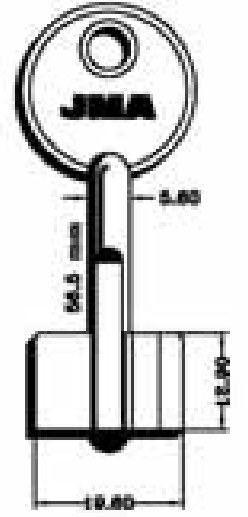



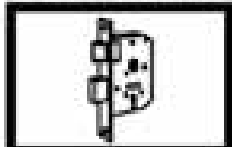

KAS-2G

Copyright by
Alejandro Allina S.A.
2018

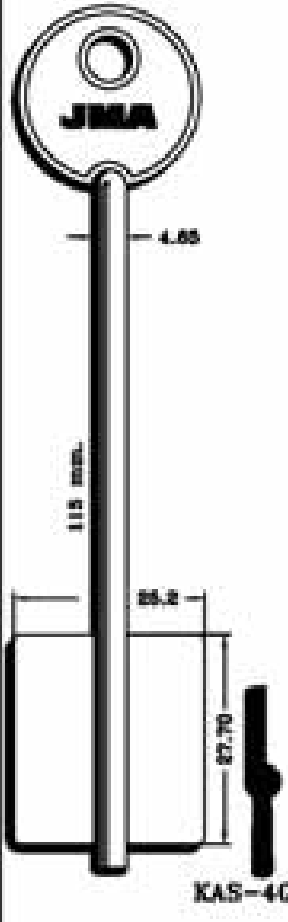
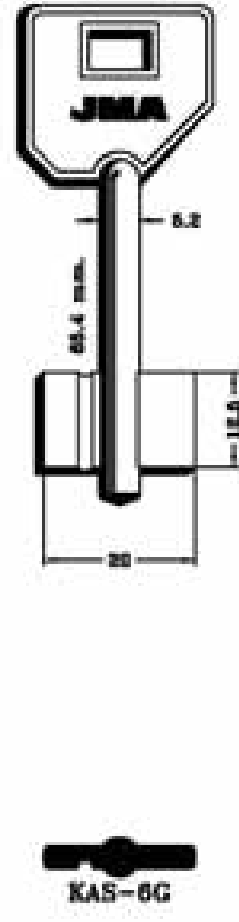

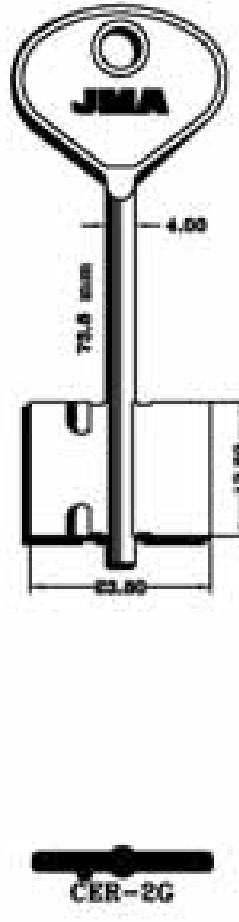
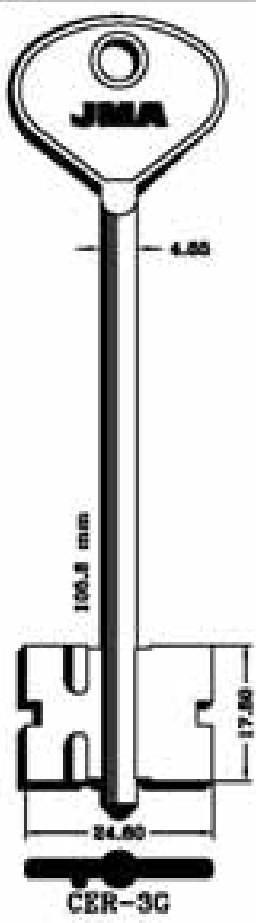
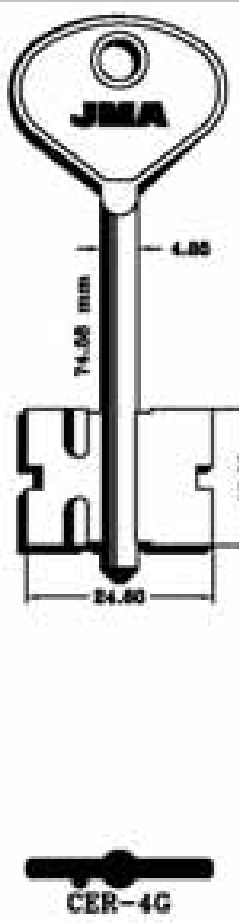
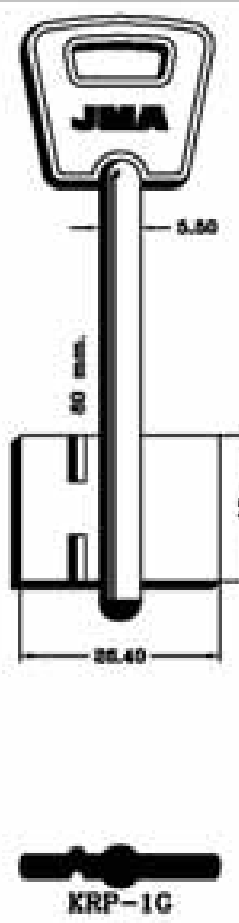
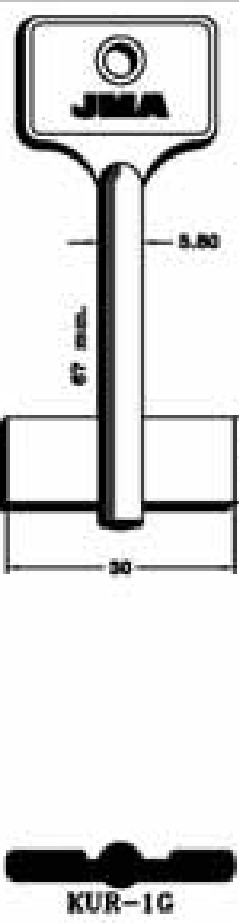
294

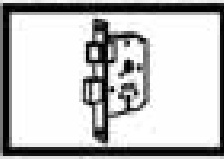
PARA FOR:	KASSEL	KERBEROS	PARA-FOR:	
 <p>115 mm. 4.00 25.2 27.70 KAS-4G</p>	 <p>65.4 mm. 5.2 11.4 25 KAS-6G</p>	 <p>100.8 mm. 4.00 17.80 23.00 CER-1G</p>	 <p>71.8 mm. 4.00 17.80 23.00 CER-2G</p>	<p>KASSEL (I) KERBEROS (RUS) KREPISH (RUS) KURZEME (RUS)</p>
PARA FOR:	KERBEROS	KREPISH	KURZEME	
 <p>100.8 mm. 4.00 17.80 24.00 CER-3G</p>	 <p>71.08 mm. 4.00 17.80 24.00 CER-4G</p>	 <p>60 mm. 5.00 19 28.40 KRP-1G</p>	 <p>67 mm. 5.00 11.2 20 KUR-1G</p>	<p>Copyright by Alejandro Almona S.A. 2018</p>   <p>295</p>

PARA-FOR:

LINCE (E)

MCM (E)

METAL (BG)

MOIA (D)

PARA-FOR:	LINCE		MCM	
	LIN-2G	LIN-3G	MCM-2G	MCM-3G

PARA-FOR:	MCM	METAL	MOIA	
	MCM-5G	MTL-1G	MOI-1G	MOI-2G

Copyright by
Alejandro Allina S.A.
2018

JMA

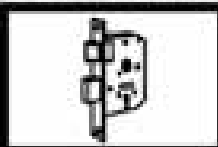

296

PARA:
FOR: MOIA

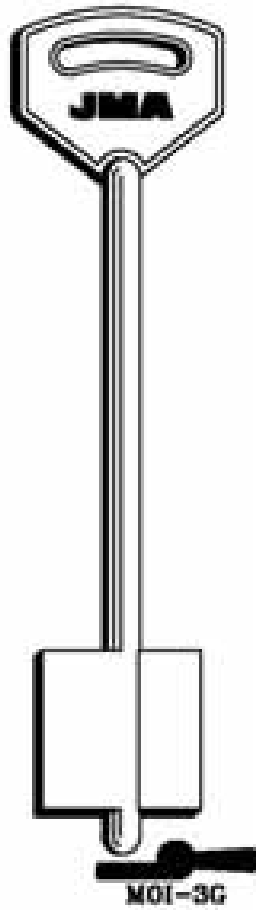

MOTTURA

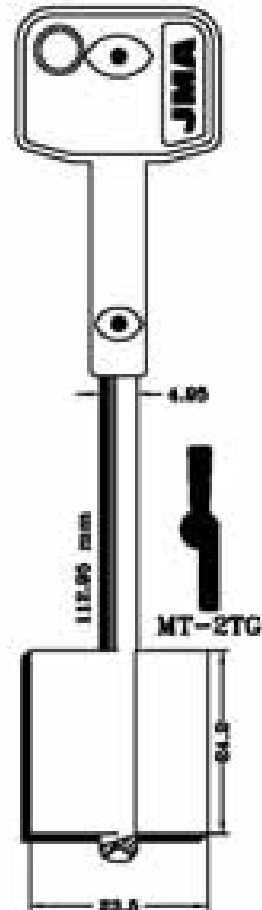
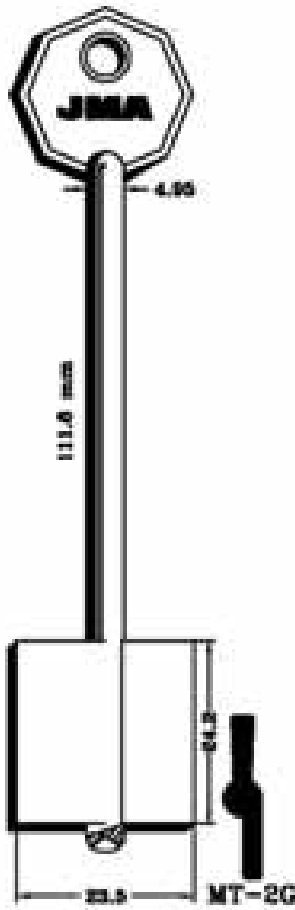
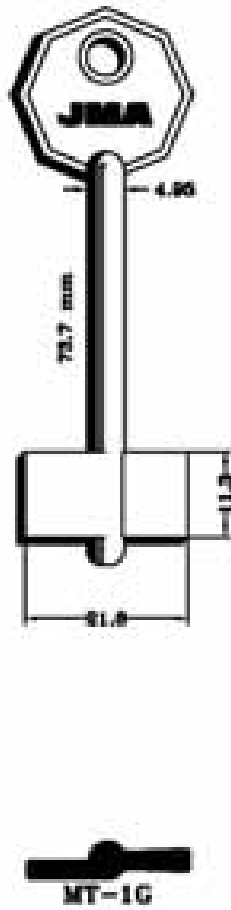

PARA-FOR:

MOIA (I)
MOTTURA (I)

PARA:
FOR: MOTTURA

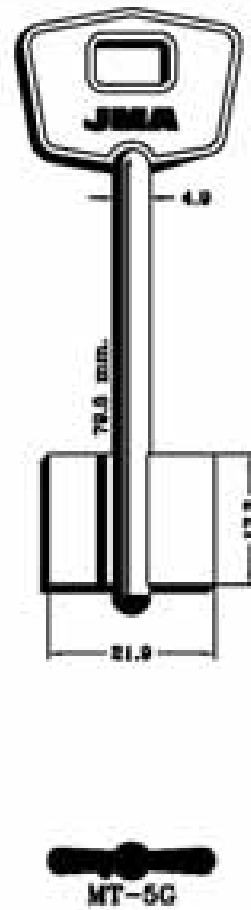
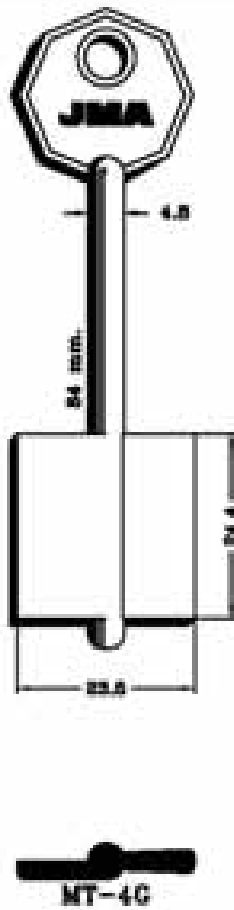
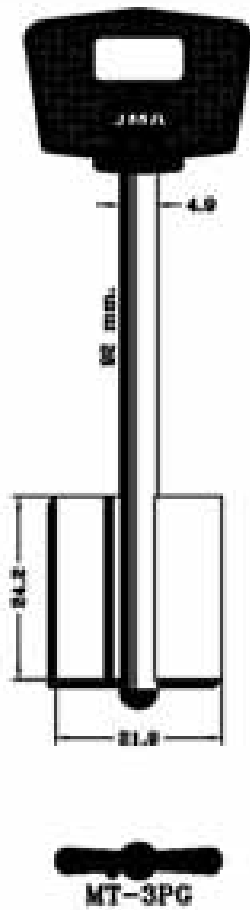
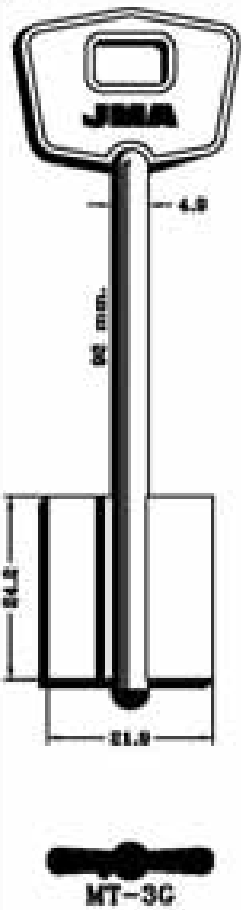

Copyright by
Alejandro Altman S.A.
2018

JMA



297

PARA-FOR:

FOR:

MOTTURA

MOTTURA (I)

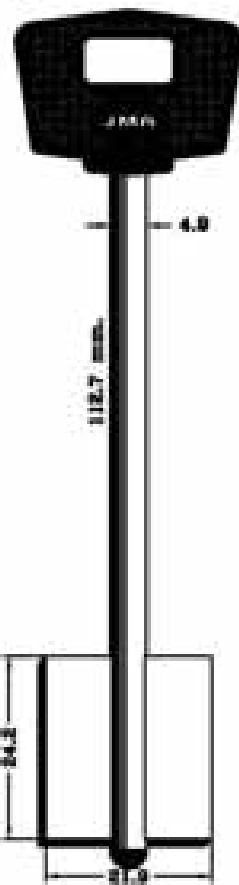
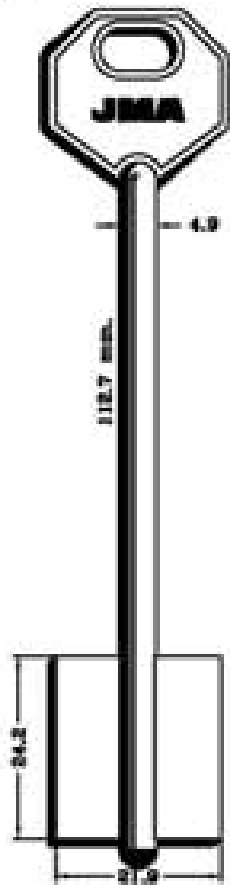

PARA-FOR:

MOTTURA

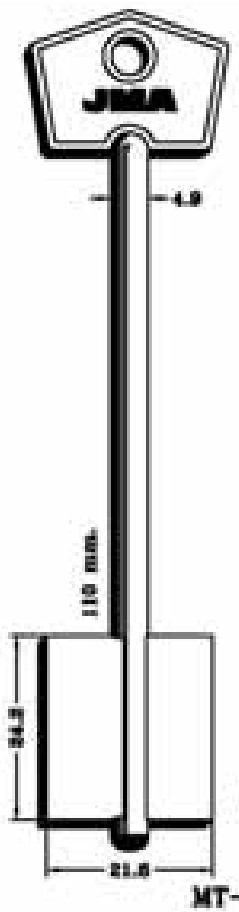
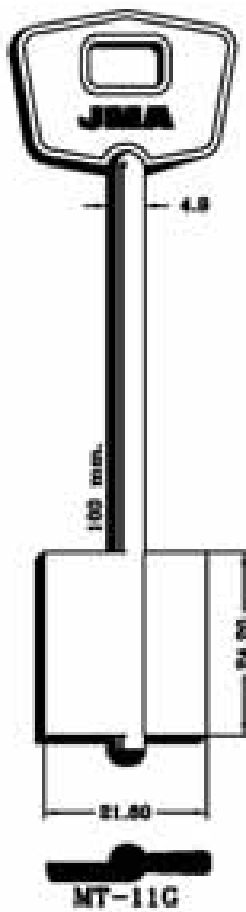
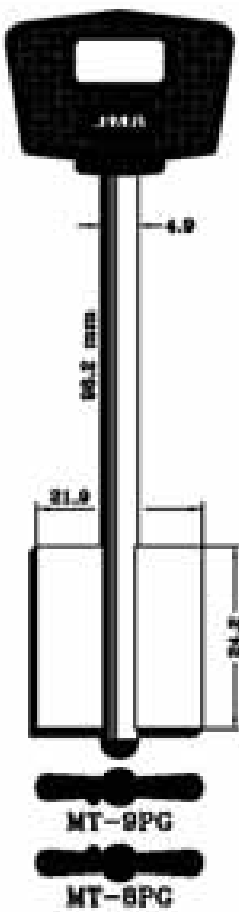
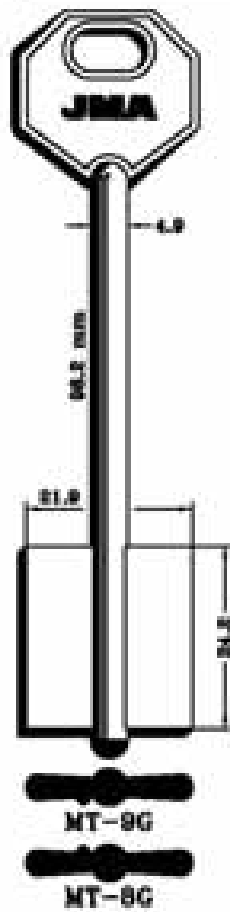

Copyright by
Alejandro Allina S.A.
2018

JMA

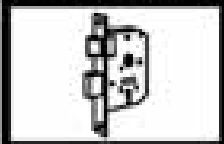

298

PARA: FOR:	MOTTURA		OMEC		PARA-FOR:
 78 mm. 14.10 21.90 4.5 MT-15G	 88 mm. 24.50 22 4.5 MT-16G	 102.5 mm. 21.8 18.8 4.5 MT-17PG	 78.8 mm. 18.3 19.7 4.4 OMC-1G		MOTTURA (I) OMEC (I) ORENGO (E) PATRONE (I) POTENT (I)

PARA: FOR:	ORENGO	PATRONE	POTENT	
 77.4 mm. 13.40 25.10 4.50 OR-2G	 PAT-1G	 65 mm. 18.8 8.1 PTN-1G	 88.7 mm. 14.10 22.80 4.50 PTN-2G	

Copyright by
Alejandro Altman S.A.
2018

JMA



299

PARA-FOR:

FOR:

POTENT

POTENT (I)

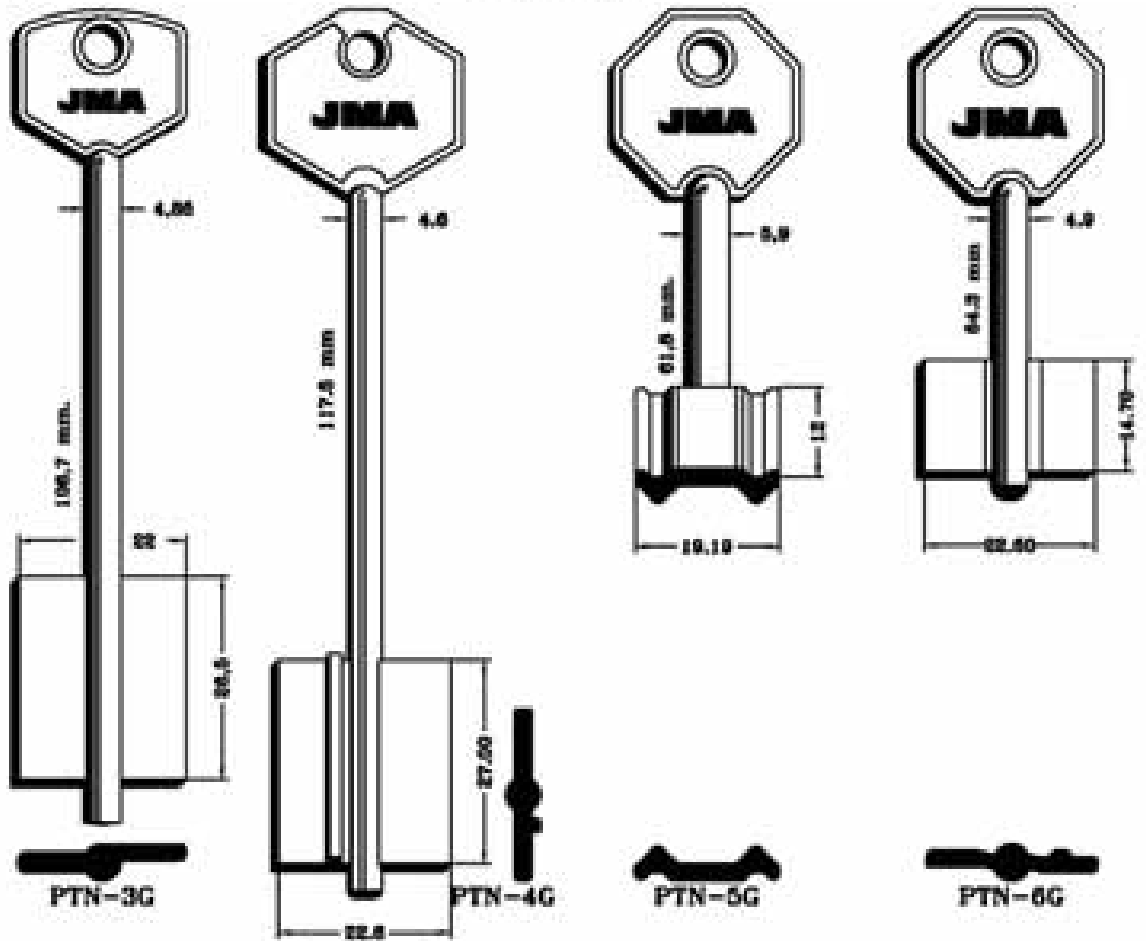

PARA-FOR:

POTENT

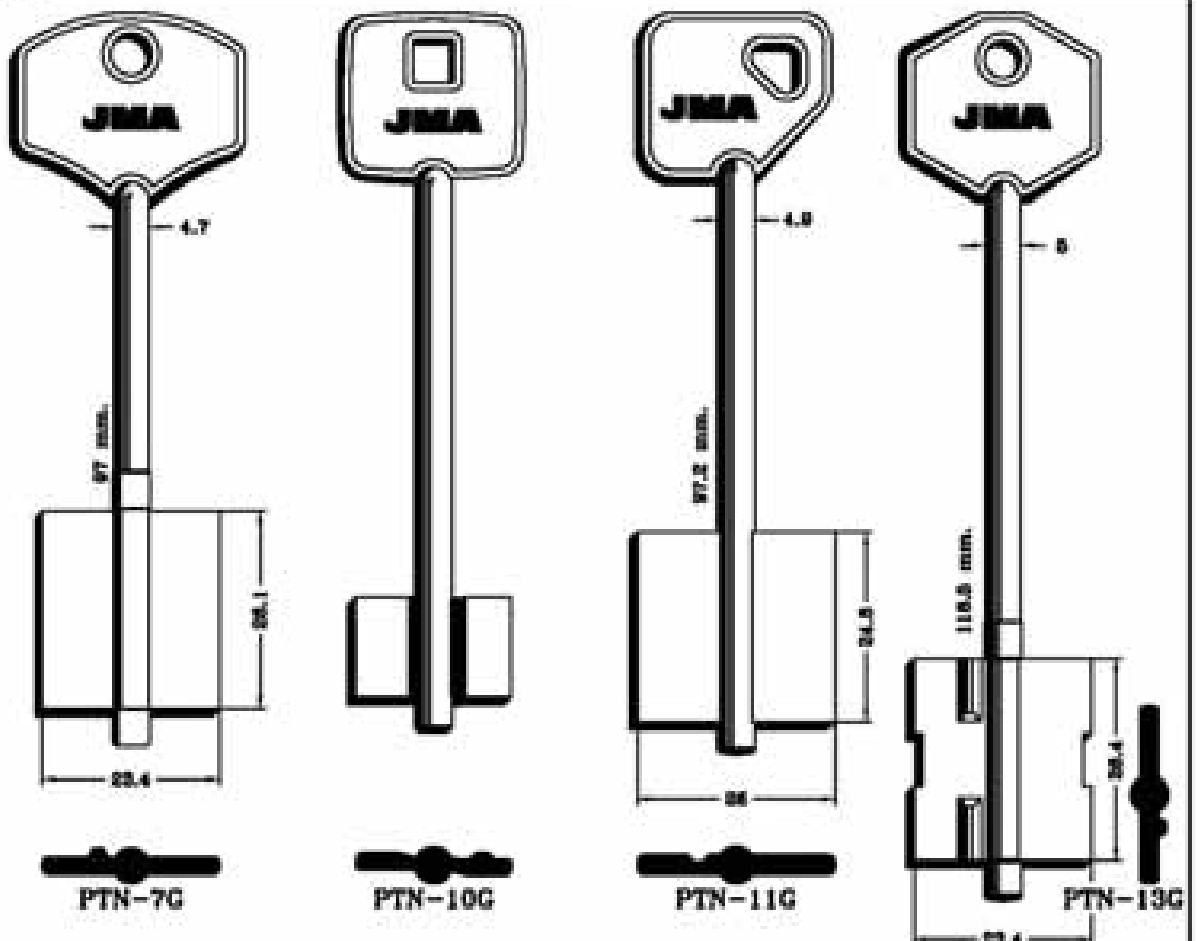





Copyright by
Alejandro Allina S.A.
2010

JMA

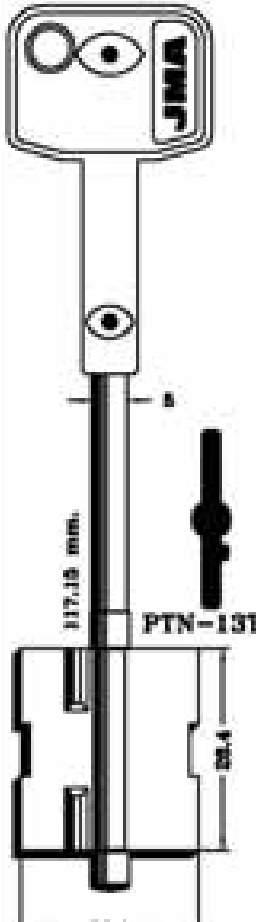
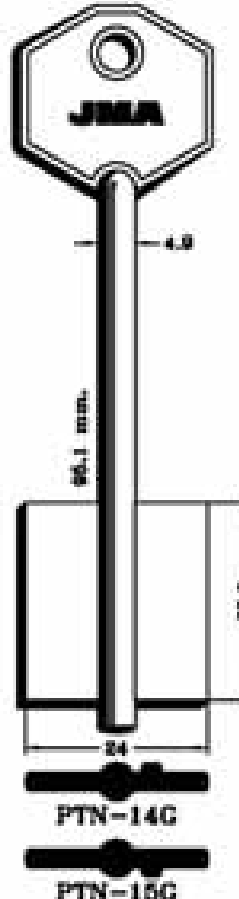
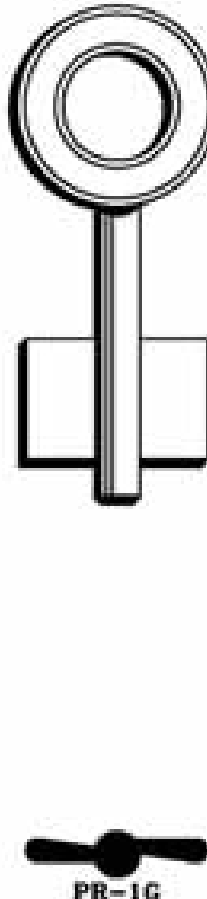
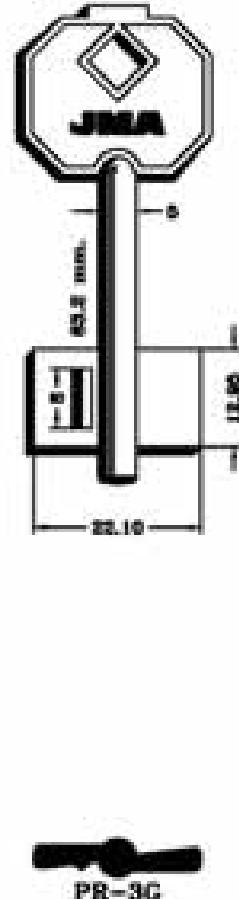
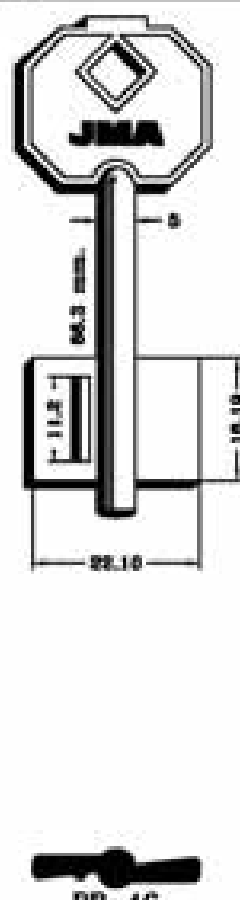
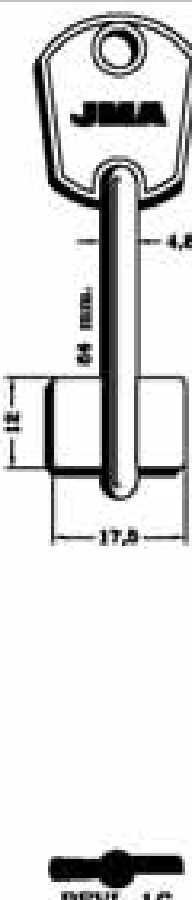

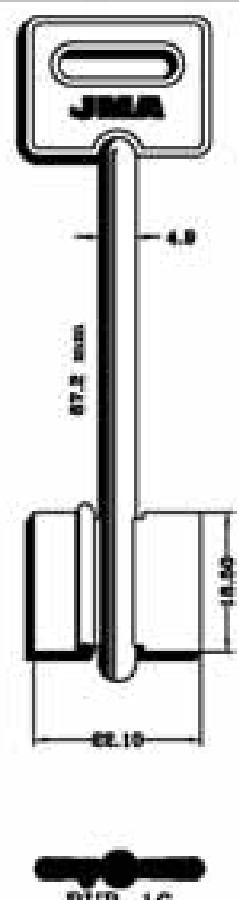
300

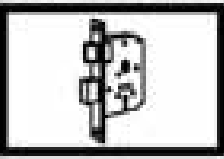
PARA FOR:	POTENT	PREFER	PREFER	PARA-FOR:
 <p>117,18 mm. PTN-13TG 22,4</p>	 <p>4,8 66,1 mm. 24 PTN-14G PTN-15G 25,9</p>	 <p>PR-1G</p>	 <p>63,3 mm. 18,10 22,10 PR-3G</p>	<p>POTENT (I) PREFER (I) REVI (E) RIGAL (RUS) RUBEN (RUS)</p>
PARA FOR:	PREFER	REVI	RIGAL	RUBEN
 <p>64,3 mm. 11,2 18,10 22,10 PR-4G</p>	 <p>4,8 64 mm. 12 17,8 REVI-1G</p>	 <p>5,44 100 mm. 18,00 22,00 RGL-1G</p>	 <p>4,8 87,2 mm. 18,00 22,10 RUB-1G</p>	<p>Copyright by Alejandro Altman S.A. 2018</p>   <p>301</p>

PARA-FOR:

RUBEN (RUS)

SAB (I)

SAFE (I)

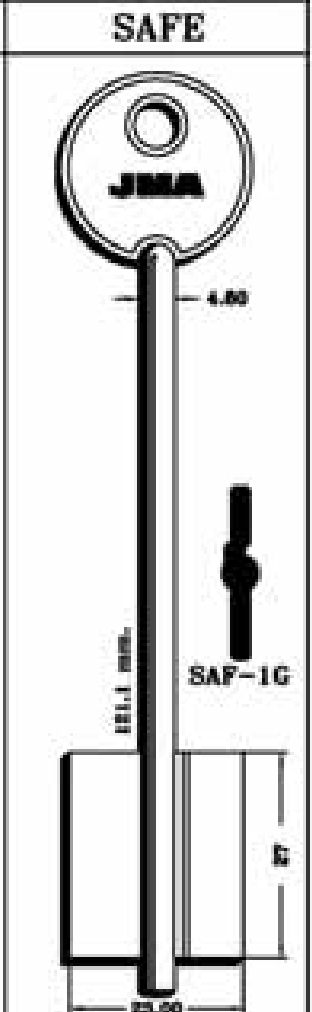
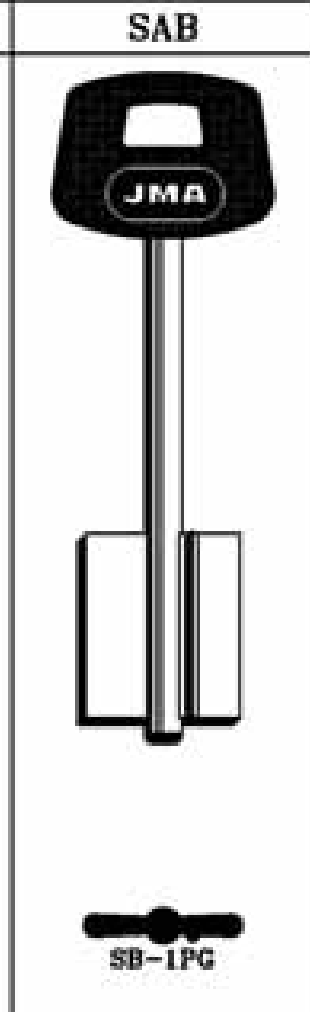
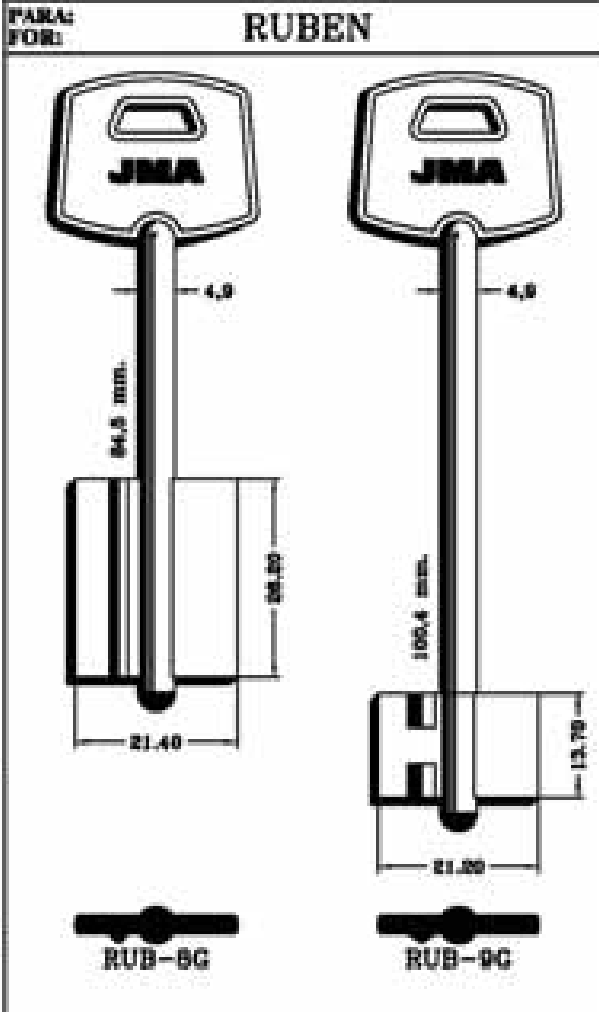
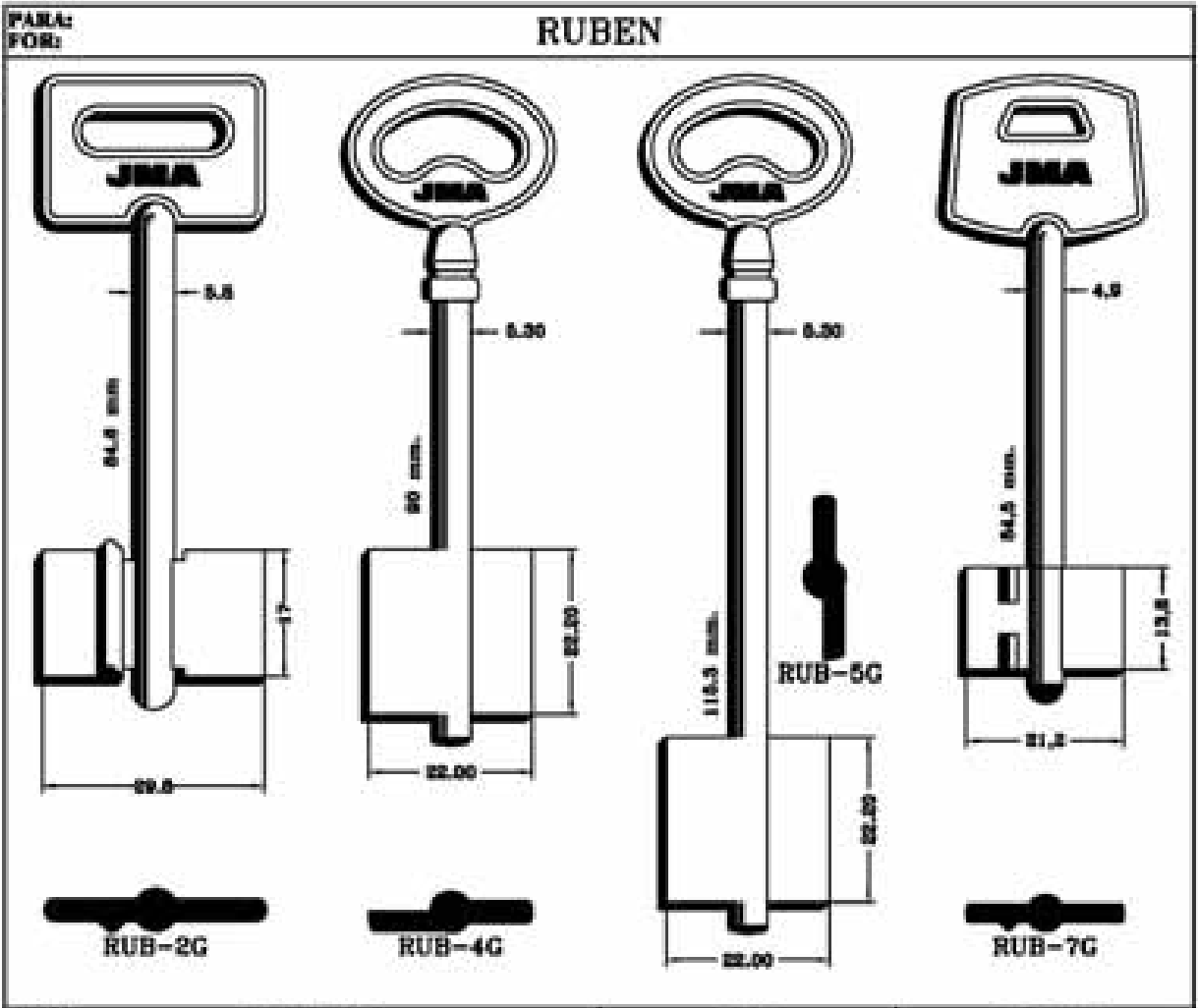

Copyright by
Allegre Altes S.A.
2018

JMA



302

PARA-FOR: SAFE

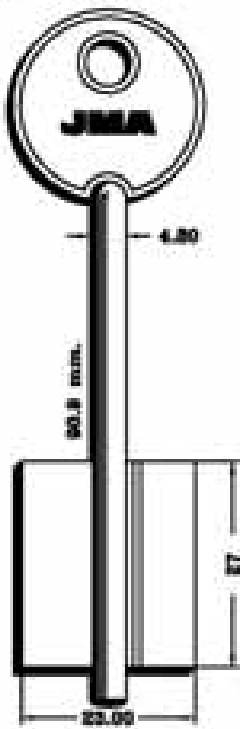

SAF-2G
MIA

SAM

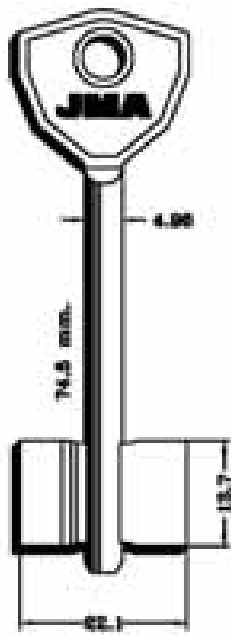

SAM-1G
BODA

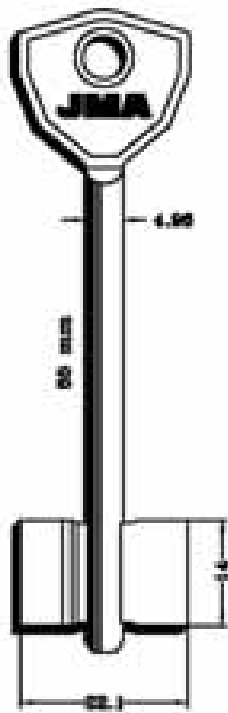

SAM-2G
BODA

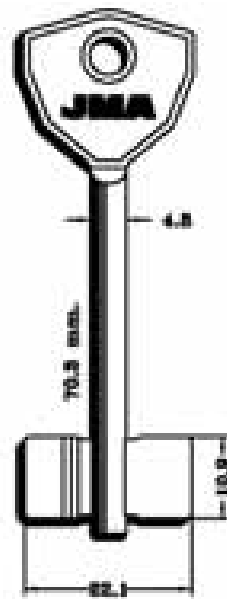

SAM-4G
BODA

PARA-FOR:

SAFE (I)

SAM (RUS)

SECUREMME (I)

PARA-FOR: SAM

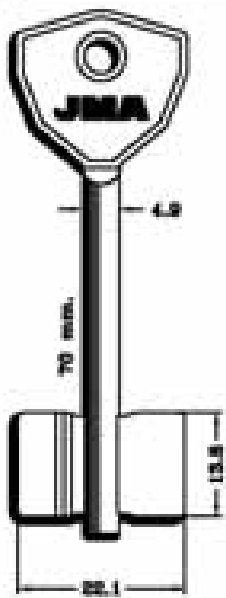

SAM-5G
BODA-CAN

SECUREMME

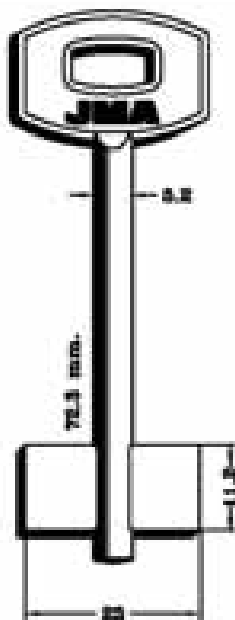

SEC-1G

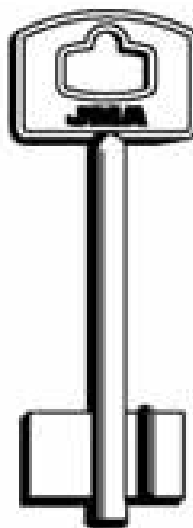

SEC-2G

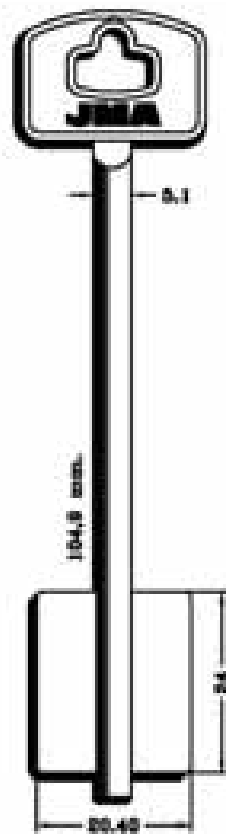

SEC-3G

Copyright by
Alejandro Altman S.A.
2018

JMA



303

PARA-FOR:

SECUREMME (I)

SERMEC (I)

SIAS (I)

SIBI (I)

PARA-FOR:	SECUREMME	SERMEC	SIAS
	<p>SEC-4G</p>	<p>SEC-7G</p>	<p>SRM-1G</p>

PARA-FOR:	SIAS	SIBI		
	<p>SIA-3G</p>	<p>SIB-2G</p>	<p>SIB-3G</p>	<p>SIB-4G</p>

Copyright by
Algodoro Alfaro S.A.
1978

JMA



304

PARA FOR: SIBI

SIB-5G

SIDERAL

SDR-1G

SDR-2G

SDR-3G

PARA-FOR:

SIBI (I)
 SIDERAL (I)
 TECSESA (E)
 TESIO (I)
 TITANO (I)

PARA FOR: TECSESA

TEC-1G

TESIO

TSI-1G

TITANO

TTN-1G





TTN-2G





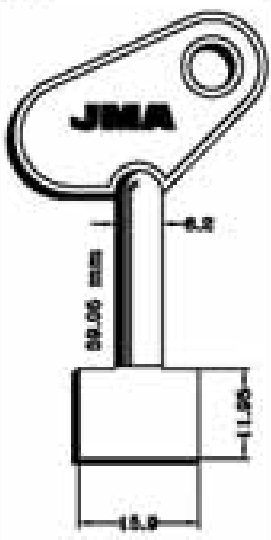
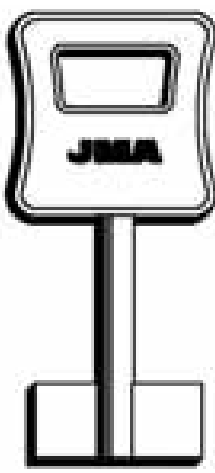
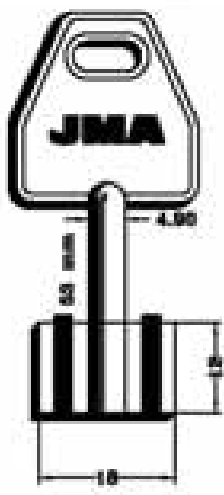
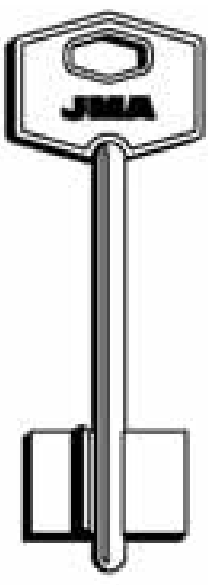

Copyright by
 Alejandro Altamir S.A.
 2010

305

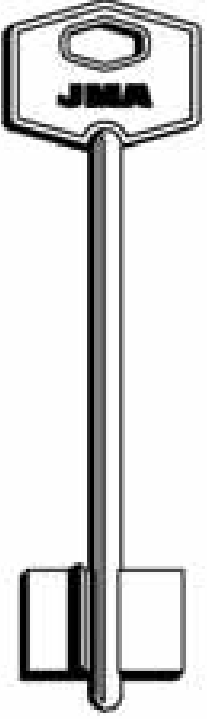
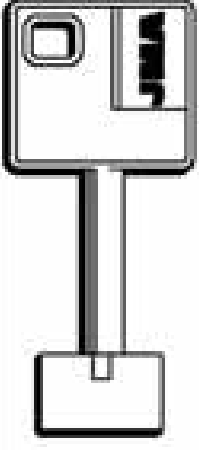
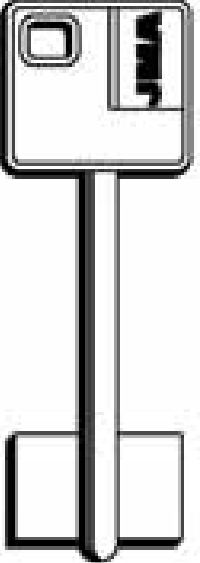
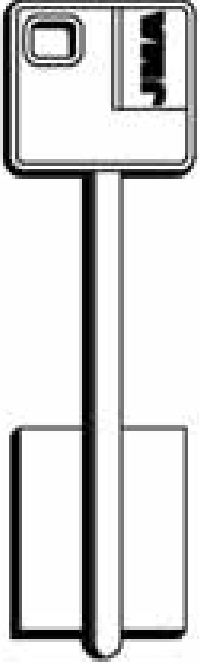
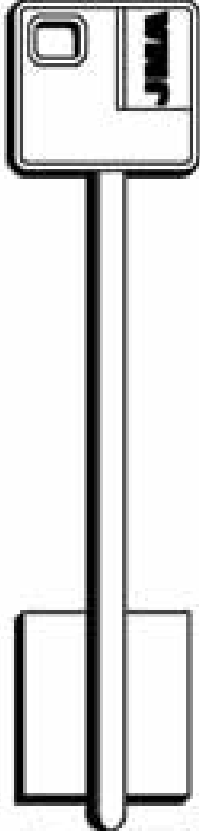
PARA-FOR:

- TOVER (E)**
- 4 TR (I)**
- TUSHINO (RUS)**
- WELKA (I)**
- YALE (I)**

PARA-FOR:	TOVER	4 TR	TUSHINO	WELKA
				
	 <p>TOV-1G</p>	 <p>TR-1G</p>	 <p>TUS-1G</p>	 <p>WE-1G</p>

PARA-FOR:	YALE				
					
	 <p>WE-2G</p>	 <p>YA-1G</p>	 <p>YA-2G</p>	 <p>YA-3G</p>	 <p>YA-4G</p>

Copyright by
Alejandro Gómez S.A.
2018

JMA

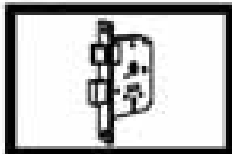

306

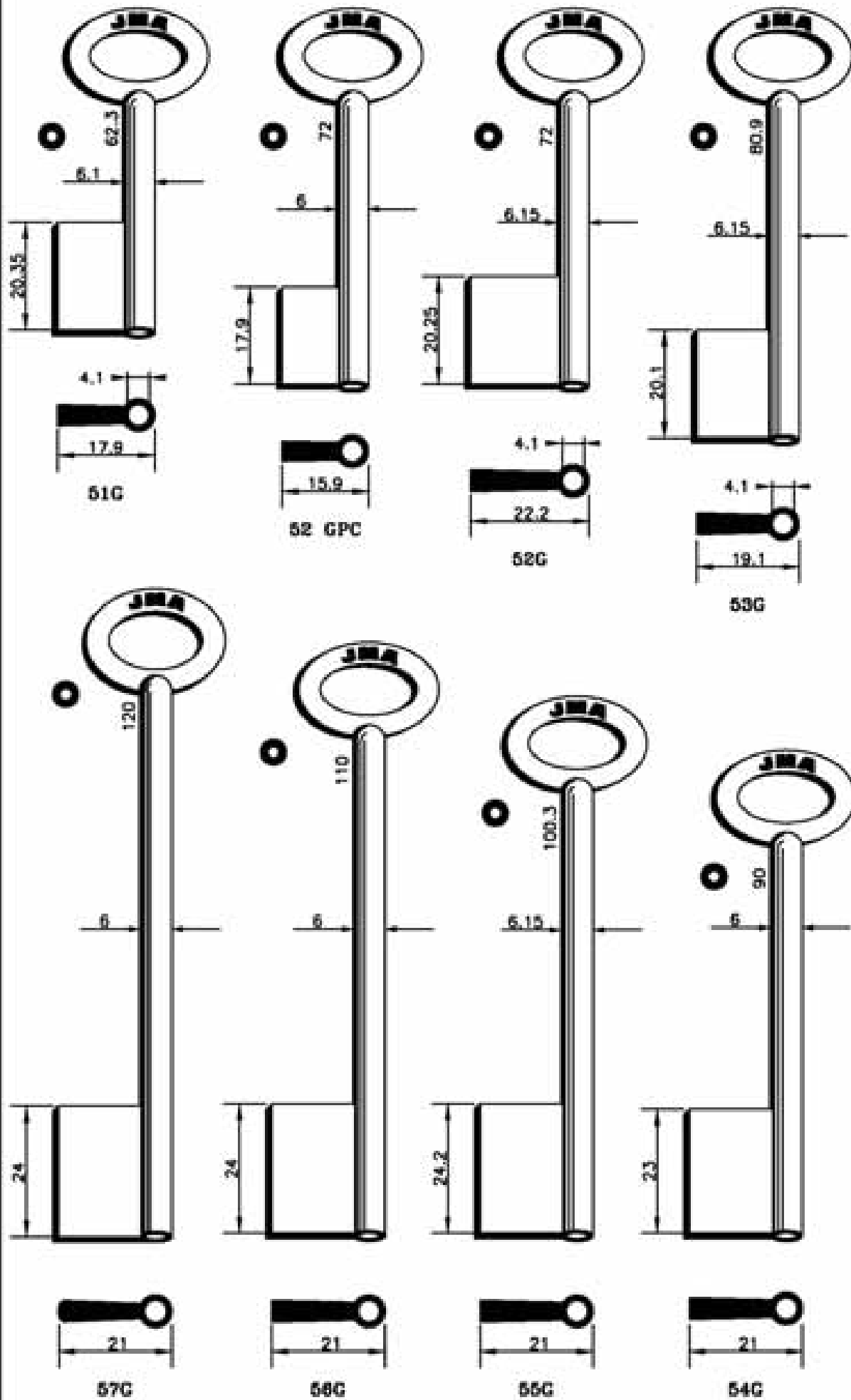

Copyright by
Alejandro Altamir S.A.
2018



307

PARA-FOR:

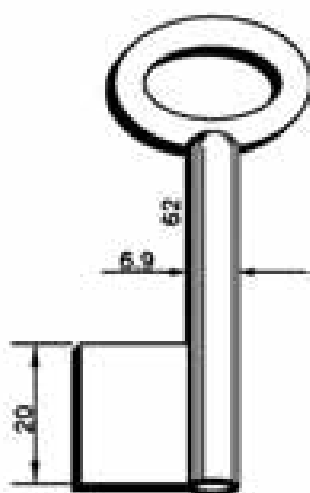

68G

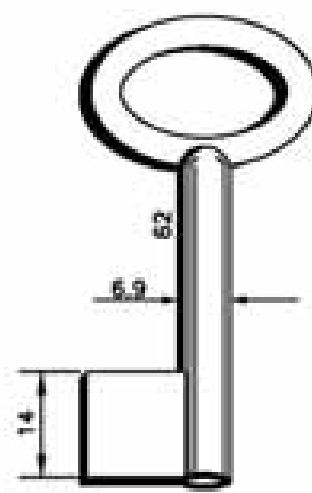

68G

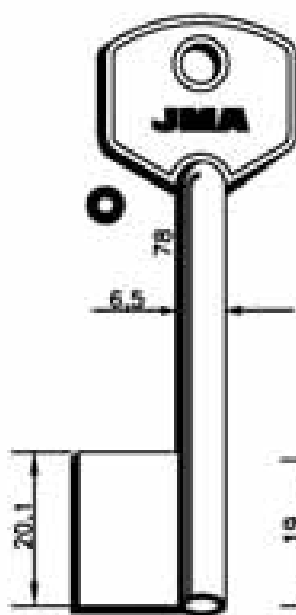

78G

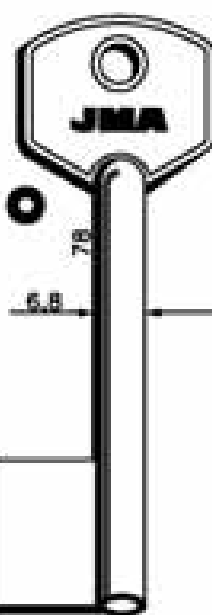

73G

Copyright by
Alejandro Allina S.A.
2018

JMA

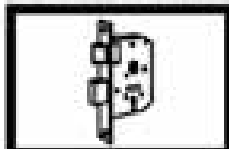

308

PARA:
FOR:

ABUS

AGA

PARA-FOR:

ABUS (D)

AGA (E)

ALEDAL (S)

ARCU (E)

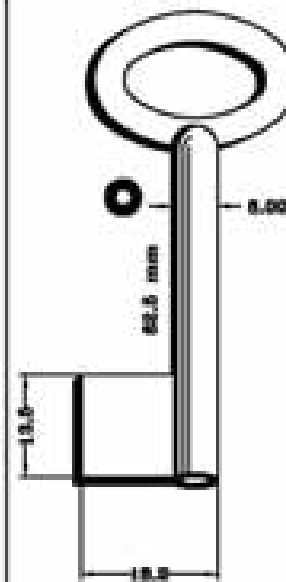
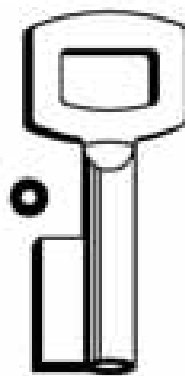
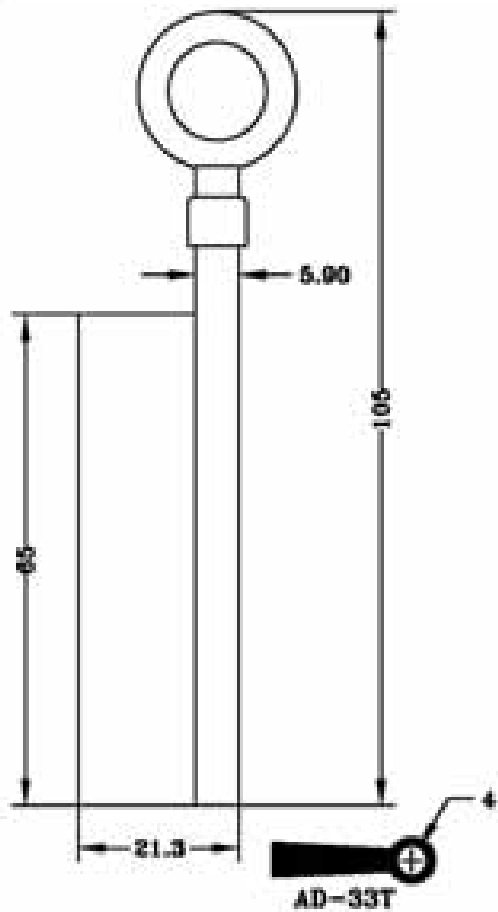

PARA:
FOR:

AGA

ALEDAL

ARCU

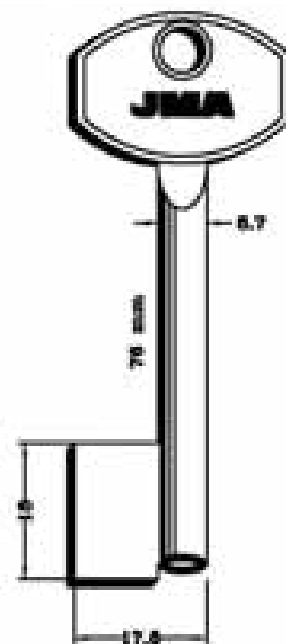
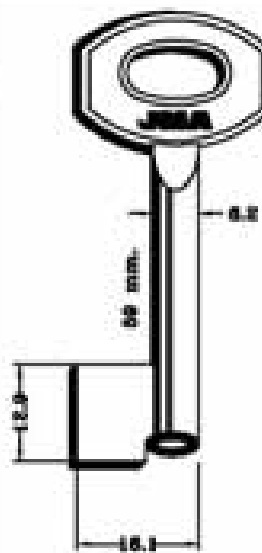
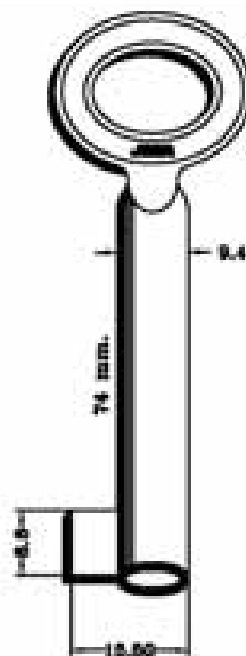
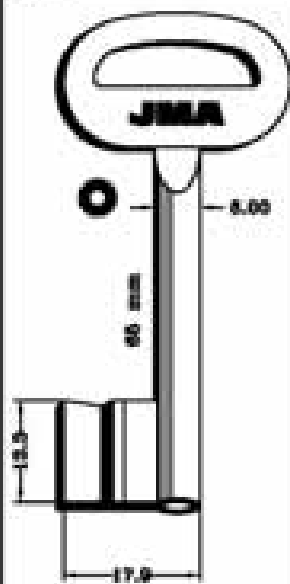

A $\phi 4.1$



B $\phi 4.1$



$\phi 7.4$



$\phi 4.1$



$\phi 4.00$



Copyright by
Alejandro Altman S.A.
2018

JMA



309

PARA-FOR:

ARC (E)

PARA FOR:

ARC

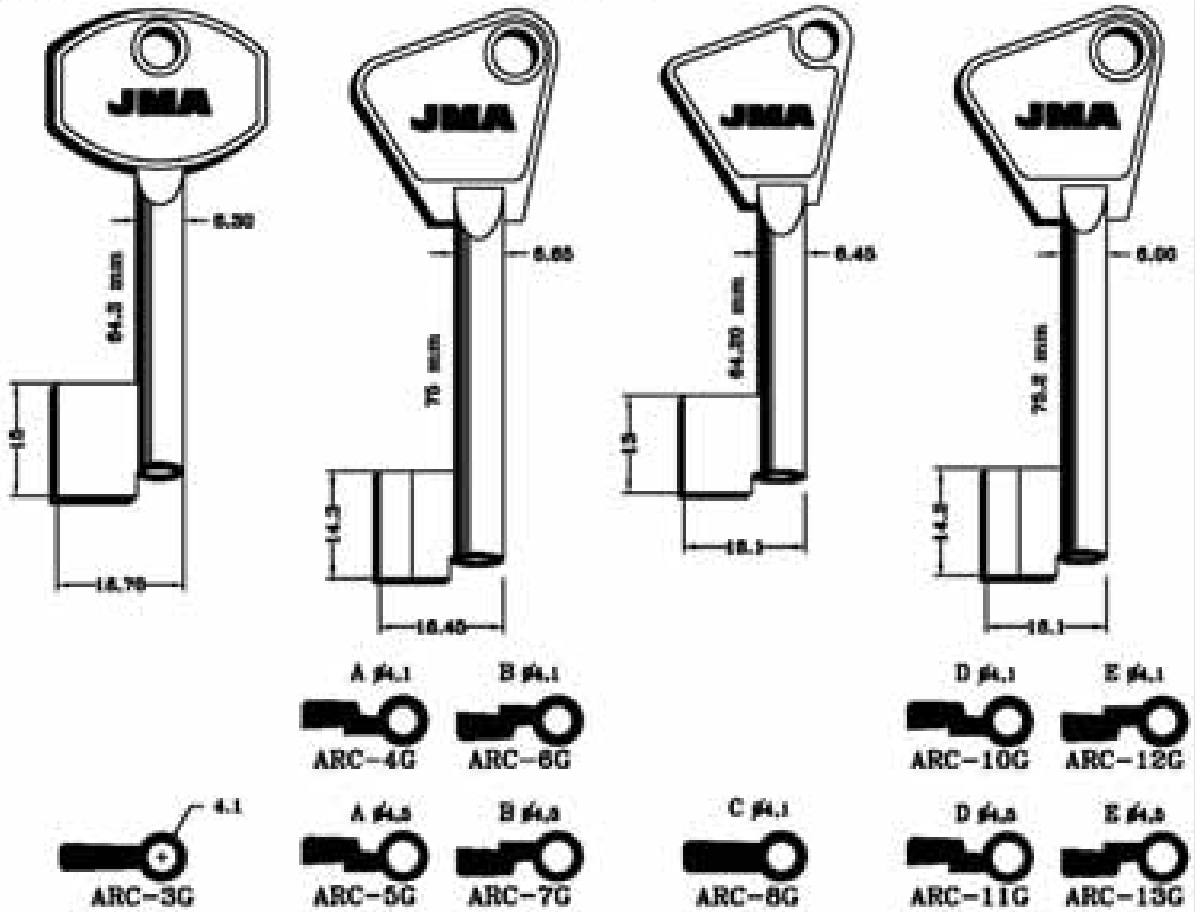

PARA FOR:

ARC

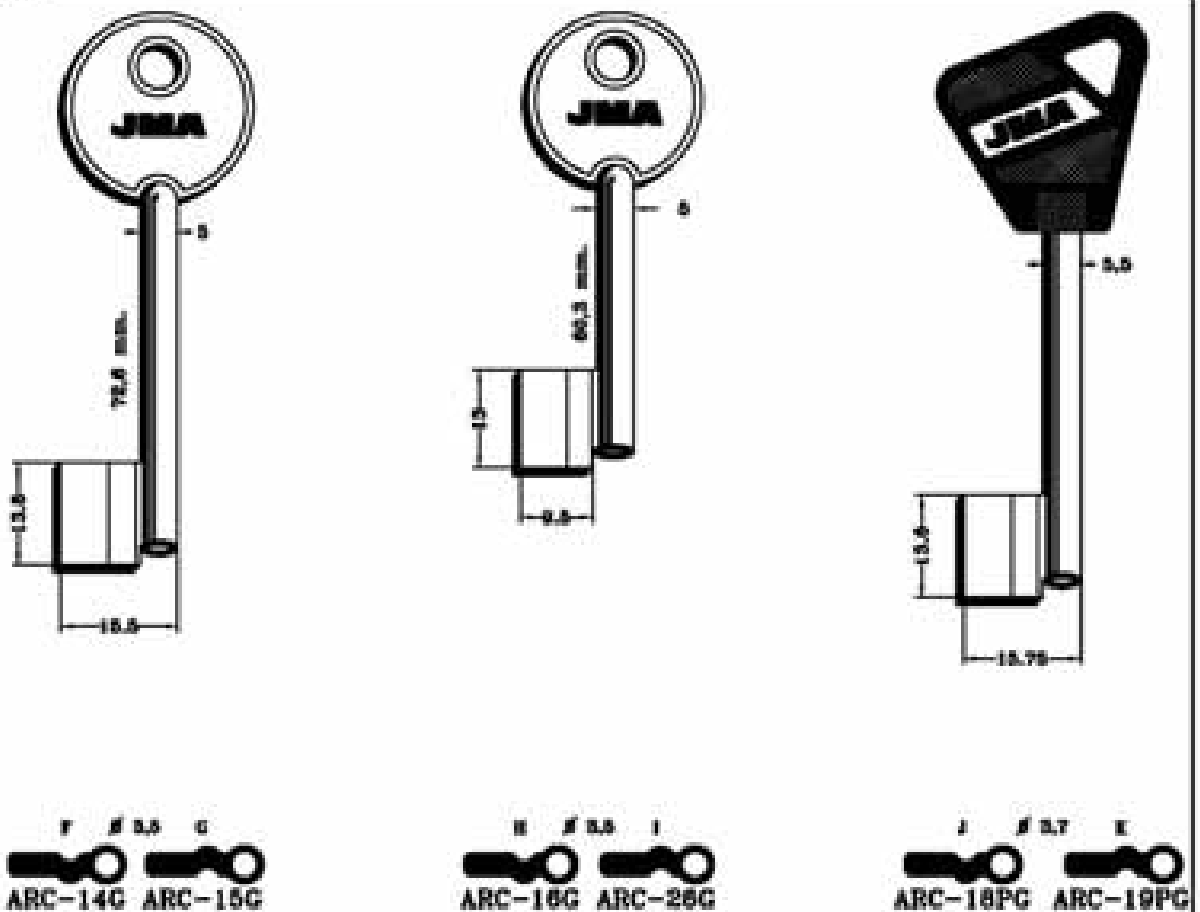

Copyright by
Alejandro Allina S.A.
2010

JMA



310

PARA:
FOR:

ARCU

ASSA

PARA-FOR:

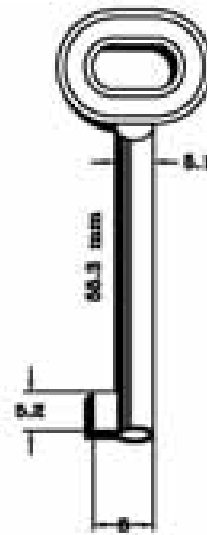
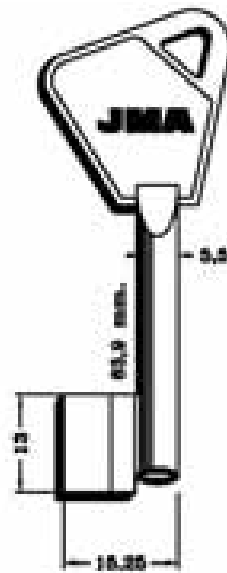

ARCU (E)

ASSA (S)

AYPE (E)

CERUTTI (I)

LAR (E)



PARA:
FOR: **AYPE**

CERUTTI

LAR

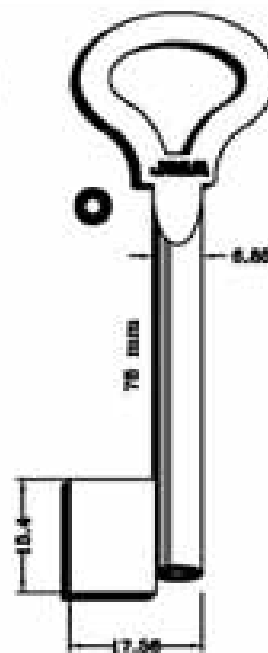
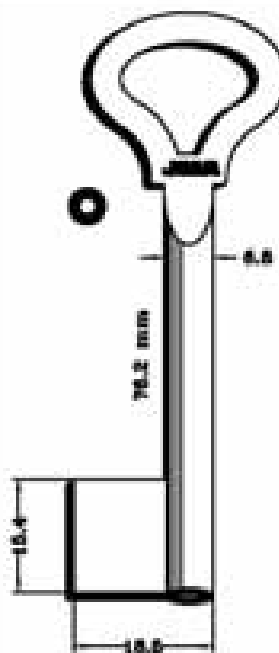
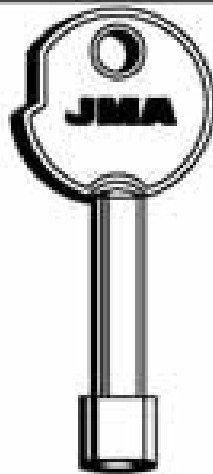
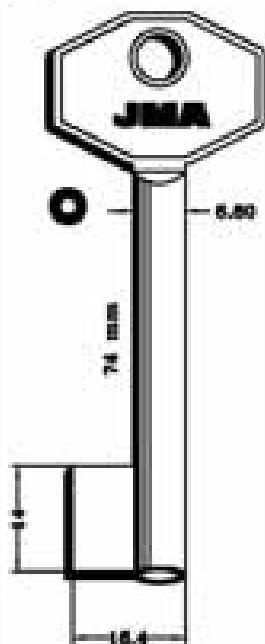

Copyright by
Alejandro Altman S.A.
2018

JMA



311

PARA-FOR:

- ORENGO (E)**
- RUBEN (RUS)**
- RUE (F)**
- VILLFER (E)**

PARA-FOR:

ORENGO

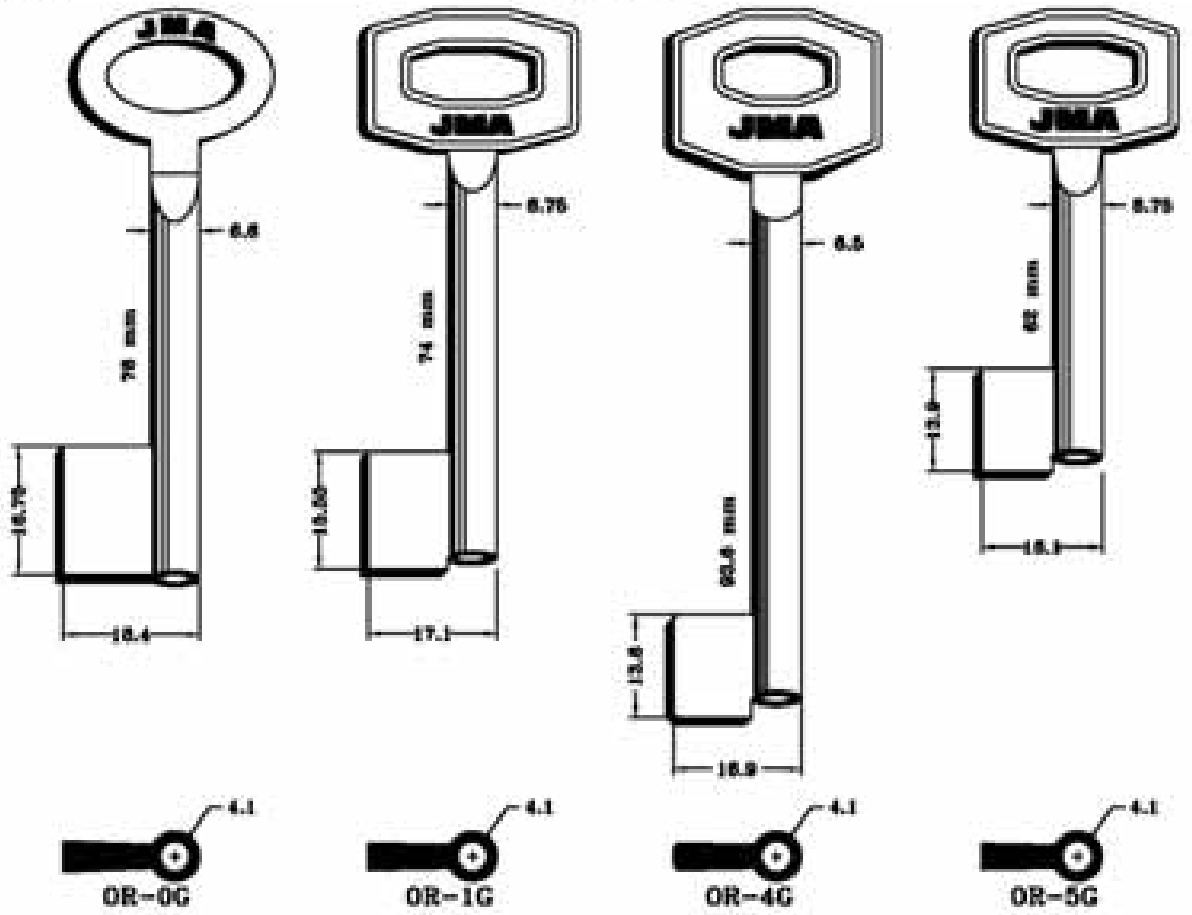

PARA-FOR:

RUBEN

RUE

VILLFER

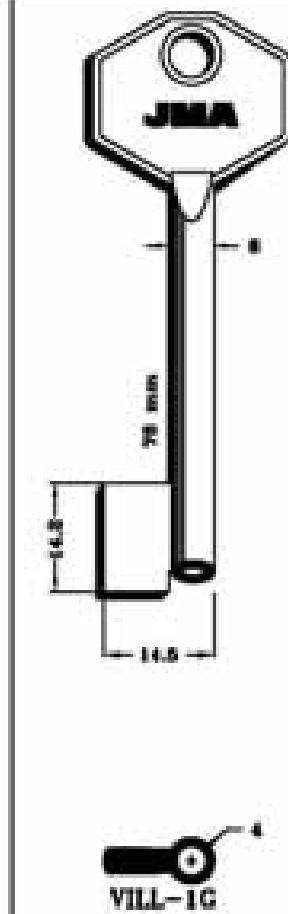
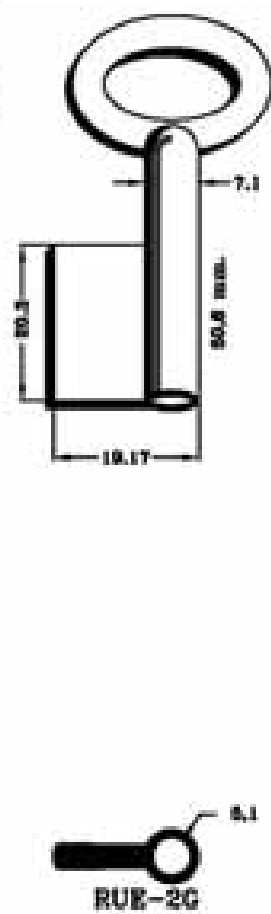
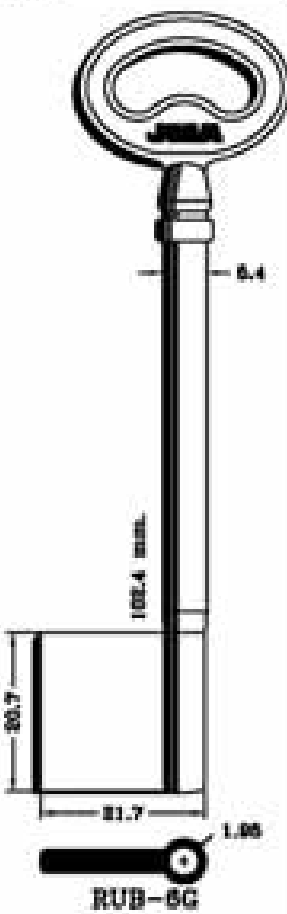

Copyright by
Alejandro Allina S.A.
2018

JMA

312

PARA:
FOR:

AGA

PARA-FOR:

AGA (E)

ARES (RUS)

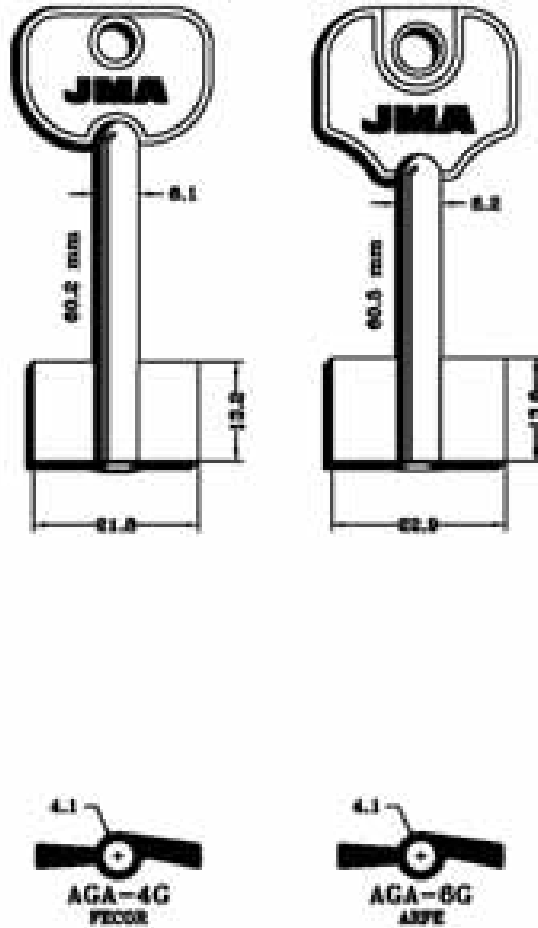
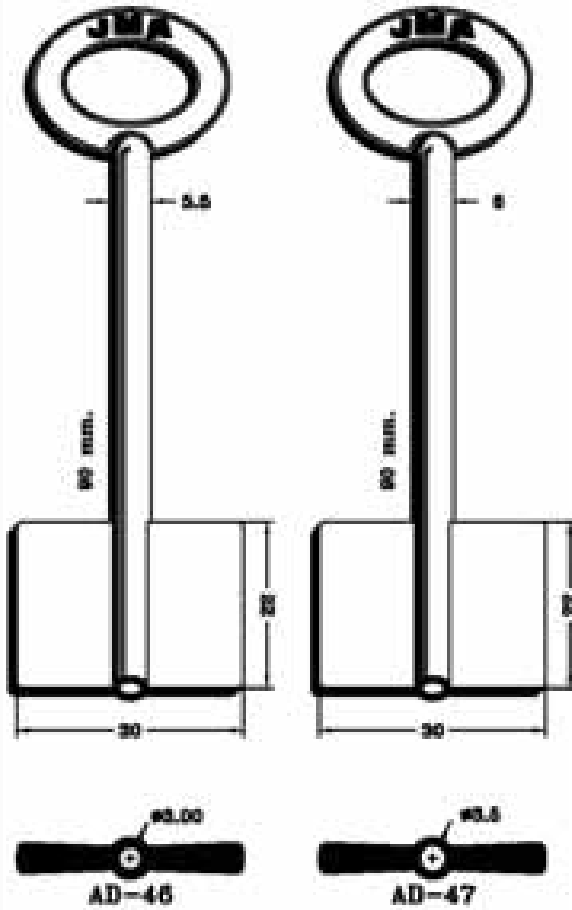

PARA:
FOR:

AGA

ARES

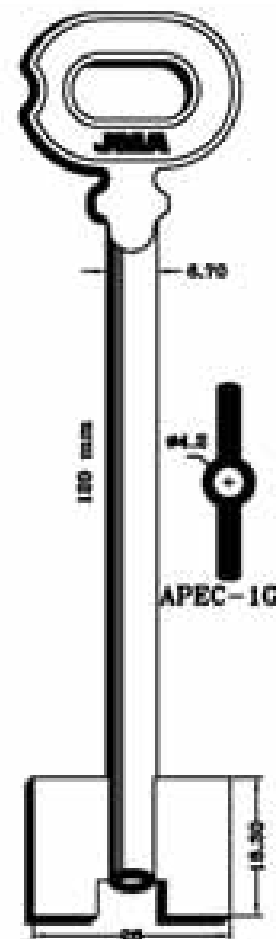
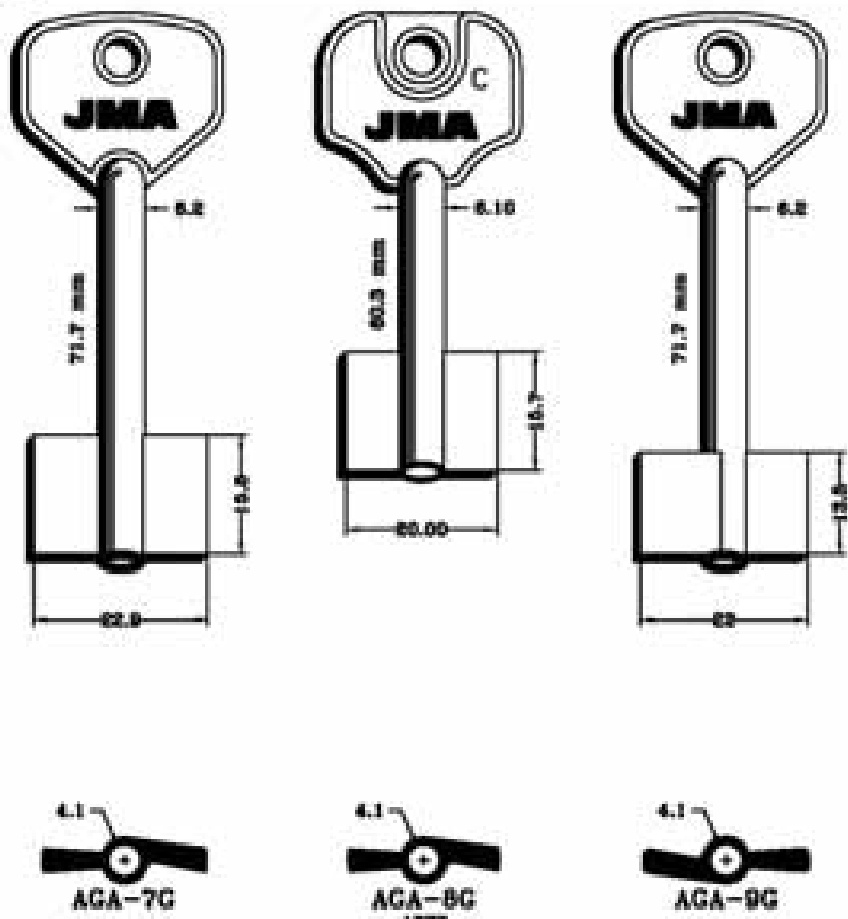

Copyright by
Alejandro Allmon S.A.
2018

JMA

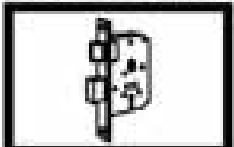

313

PARA-FOR:

ARES (RUS)

BURG (D)

DUPLEX (RUS)

DVERNIAK (RUS)

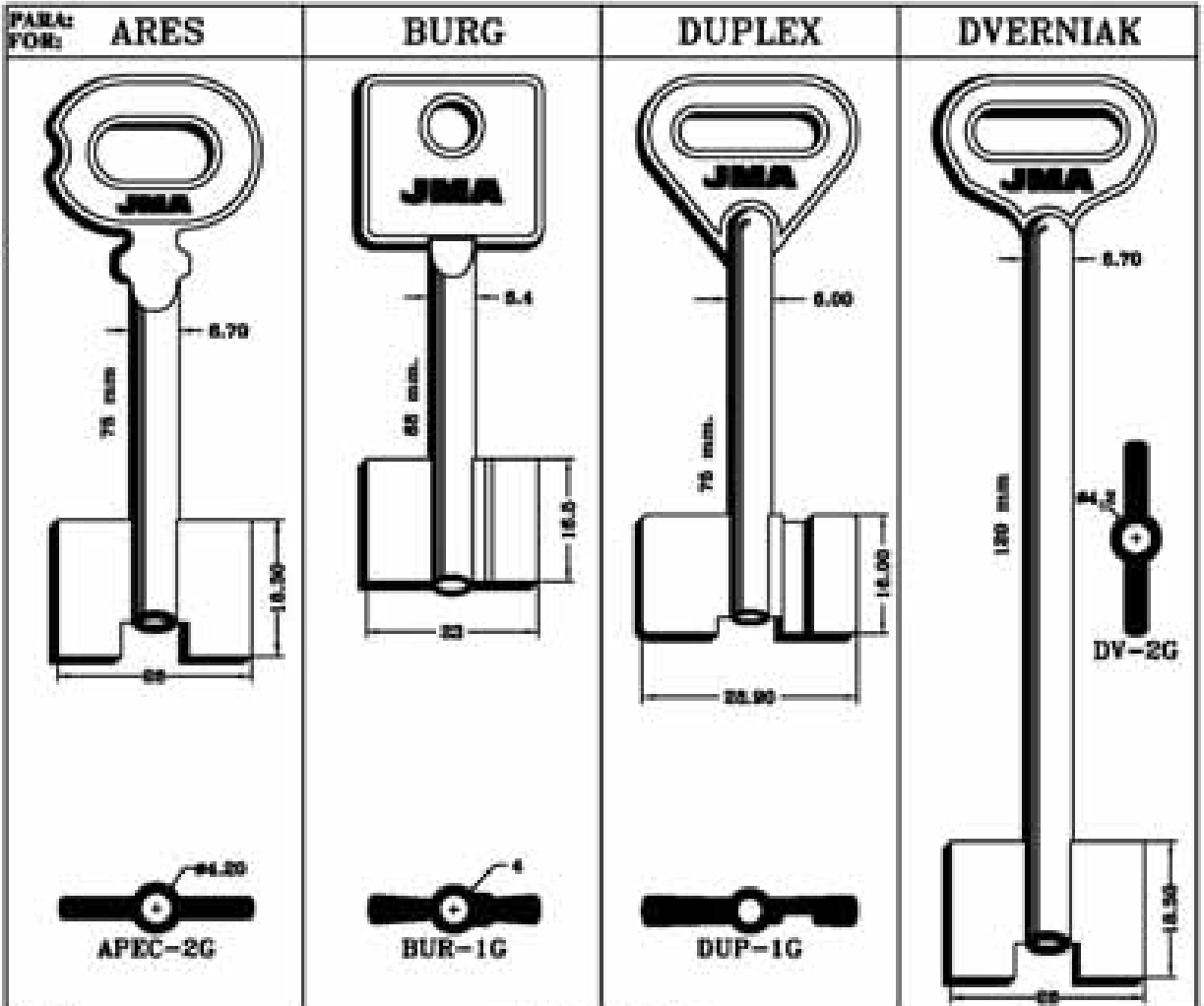

PARA-FOR: **DVERNIAK**

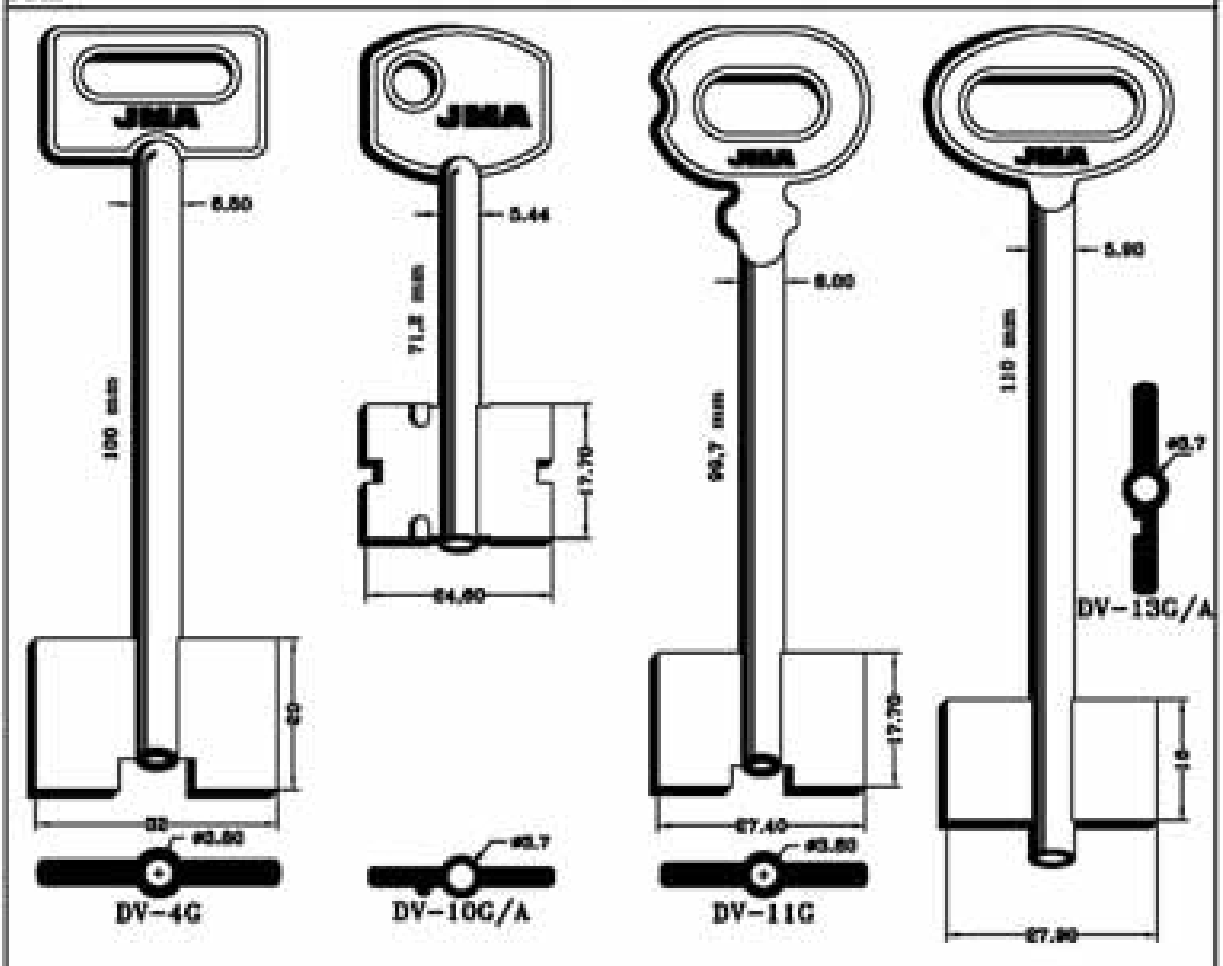

Copyright by
Alejandro Allende S.A.
2018

JMA

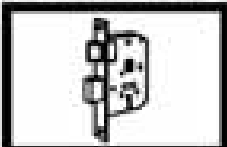

314

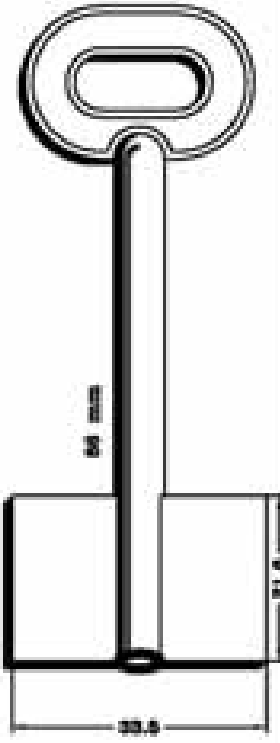
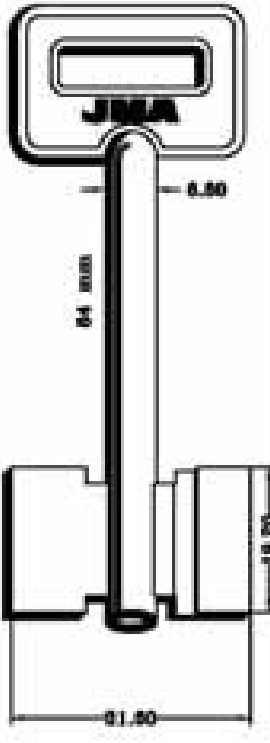
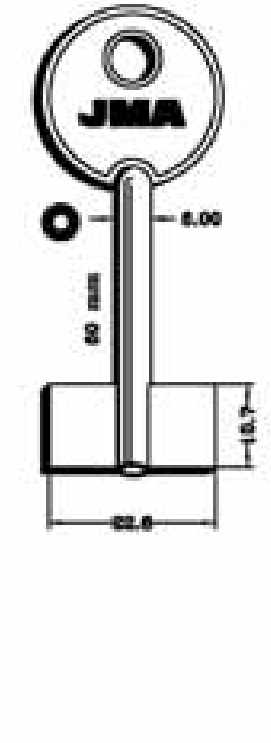
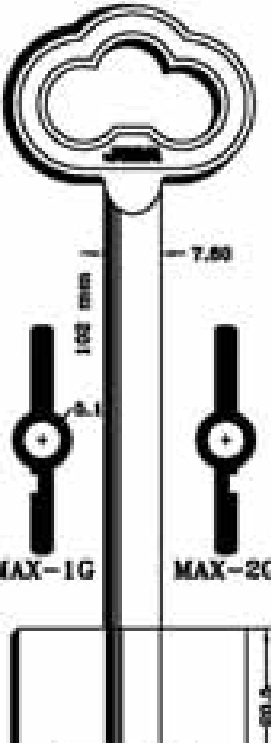
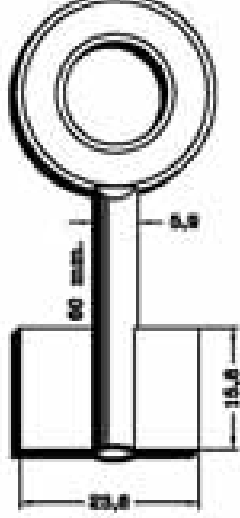
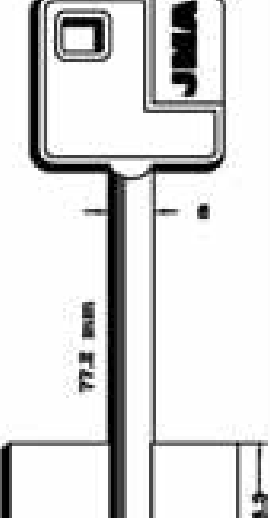
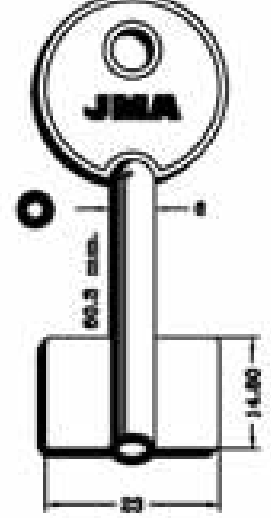
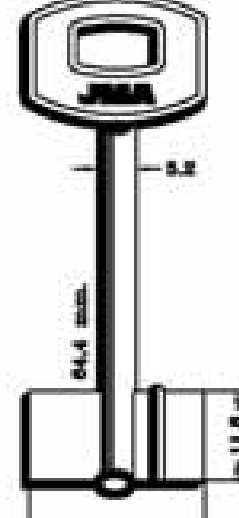
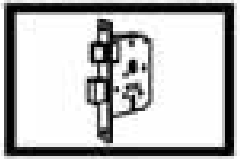
PARA: FOR:	DVERNIAK	EREVAN	MACOR	MAXIM	PARA-FOR:
	 <p>DV-17G</p>	 <p>ERV-3G/A</p>	 <p>MAC-1G</p>	 <p>MAX-1G MAX-2G</p>	<p>DVERNIAK (RUS)</p> <p>EREVAN (RUS)</p> <p>MACOR (E)</p> <p>MAXIM (RUS)</p> <p>PREFER (I)</p> <p>RUBEN (RUS)</p> <p>SERRALLER (E)</p> <p>SIBI (I)</p>
PARA: FOR:	PREFER	RUBEN	SERRALLER	SIBI	
	 <p>PR-2G</p>	 <p>RUB-3G</p>	 <p>SER-1G ASPE</p>	 <p>SIB-1G ASPE</p>	<p>Copyright by Alejandro Affonso S.A. 2018</p> <p>JMA</p>  <p>315</p>

LLAVES DE GORJA ZAMAK

ZAMAKEZKO GORJA GILTZAK

ZAMAK BIT KEYS

CLÉS À GORGES EN ZAMAK

CHUBBSCHLÜSSEL AUS ZAMAK



THE KEY TO EXCELLENCE
GLOBALLY UNLOCKING MILLIONS OF DOORS DAILY

PARA-
FOR: CAS CISMA

NEMEF

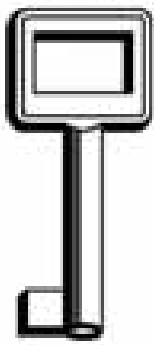

TAM.

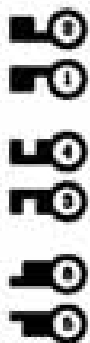

CIS-803/....

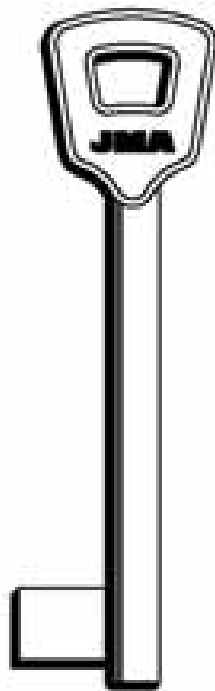

TAM.

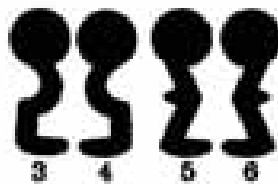

NEF-22-...

BMS-FM-YACIETTE

PARA-FOR:

**CAS CISMA
(I)**

NEMEF (D)

Copyright by
Alejandro Almon S.A.
2018

JMA



317

LLAVES ARTÍSTICAS Y DE ARMARIO LATÓN

LETOIZKO GILTZAK: ARMAIRUETARAKO ETA ARTISTIKOAK

BRASS FURNITURE KEYS

CLÉS POUR MEUBLES EN LAITON

MOBELSCHLÜSSEL AUS MESSING



THE KEY TO EXCELLENCE
GLOBALLY UNLOCKING MILLIONS OF DOORS DAILY

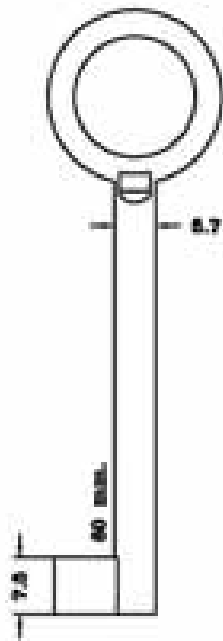

A-0G A-0G CV

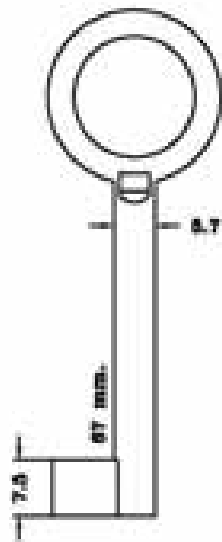

A-1G A-1G CV



A-1G/1 A-1G/2



A-1G/3 A-1G/4



A-1G/5 A-1G/6

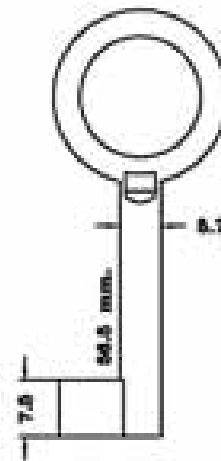

A-2G A-2G CV

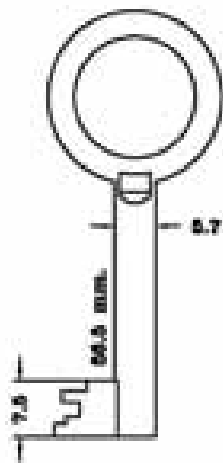

A-2G/1

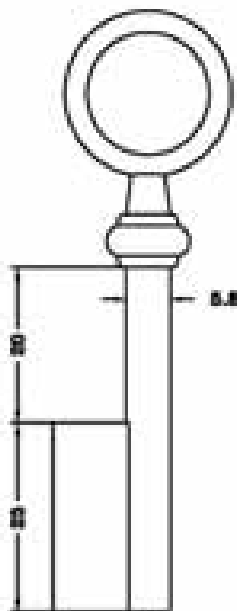

A-3G A-3G CV

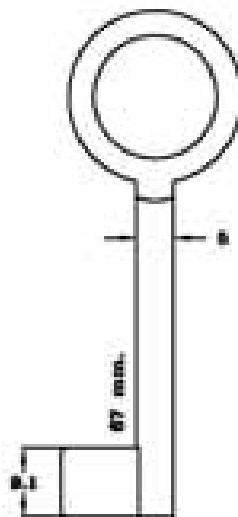

A-4G

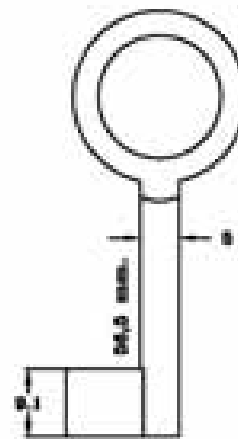

A-5G

Copyright by
Allegre Almas S.A.
2018

JMA



319

PARA-FOR:

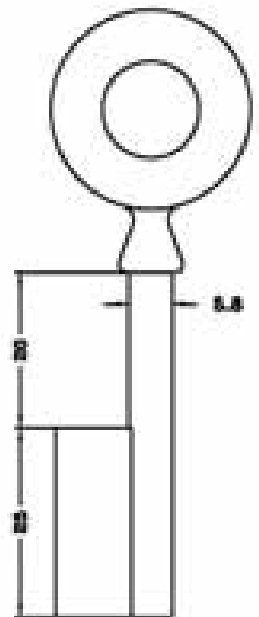
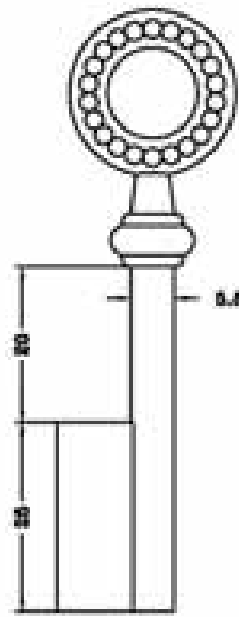
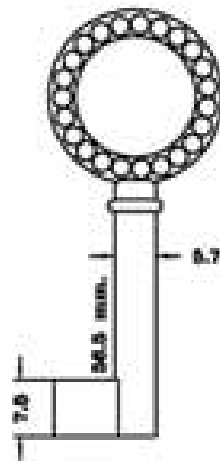
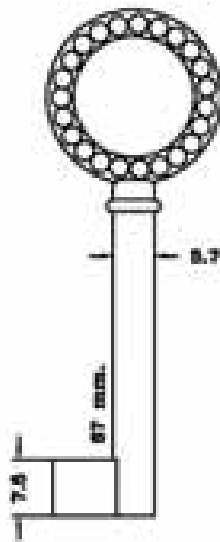

AA-1G AA-1G CV



AA-2G AA-2G CV



AA-3G AA-3G CV



B-3G B-3G CV

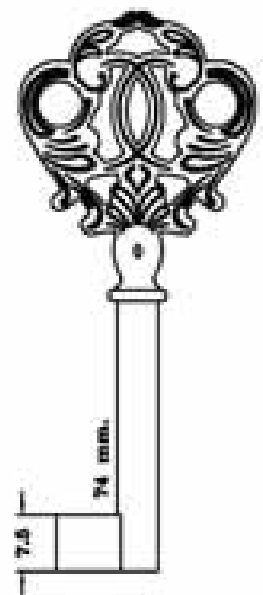
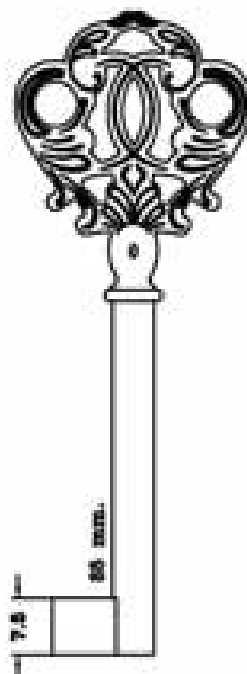
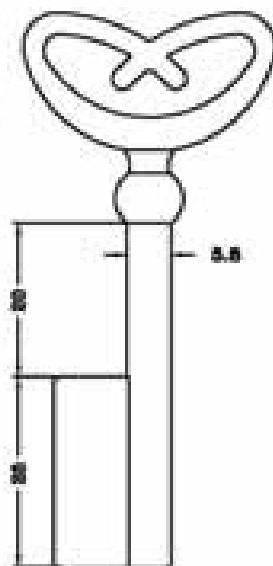
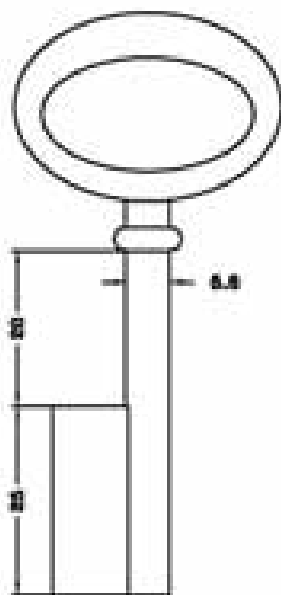

C-3G C-3G CV



D-3G D-3G CV



E-0G E-0G CV



E-1G E-1G CV

Copyright by
Algebra Altim S.A.
1978

JMA



320

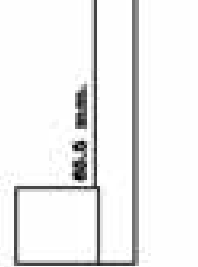
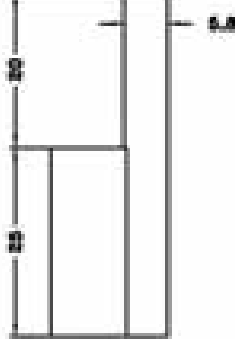
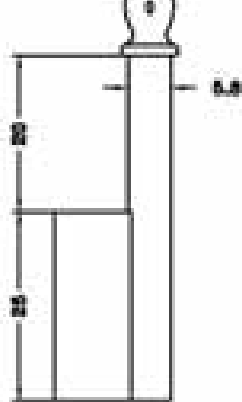
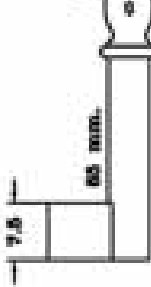
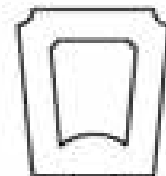

E-2G E-2G CV

E-3G E-3G CV

H-3G H-3G CV

I-1G I-1G NIQ.

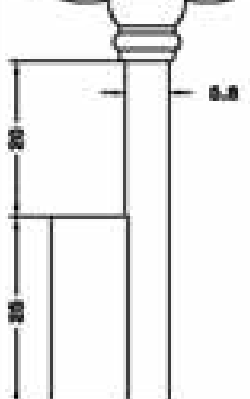
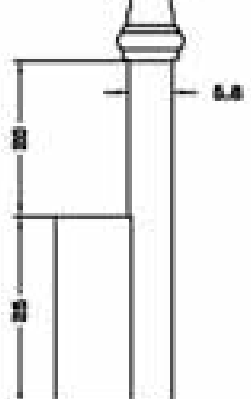
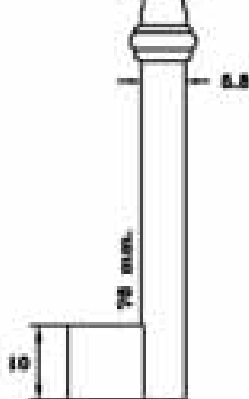
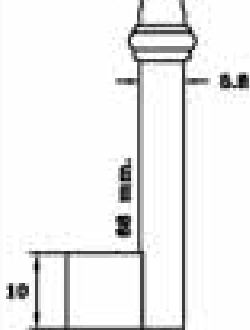
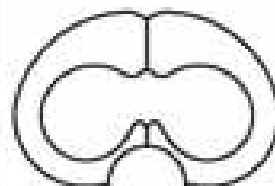
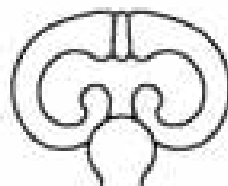
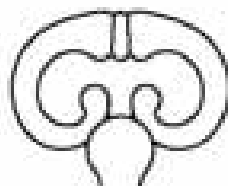
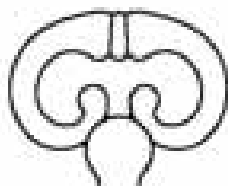

J-1G CV

J-2G CV

J-3G J-3G CV

L-3G L-3G CV

Copyright by
Aljeandro Almon S.A.
2018

JMA



321

PARA-FOR:

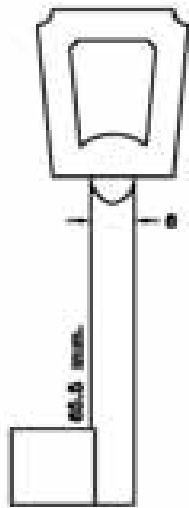

18
#4.00
N-1G N-1G NIQ.

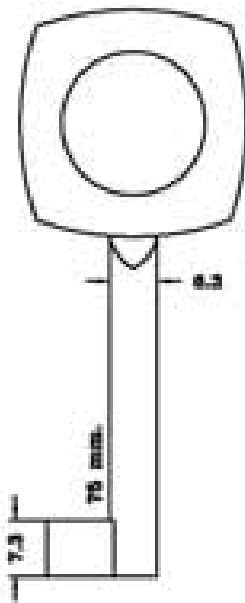

14.00
#4
U-1G U-1G NIQ.

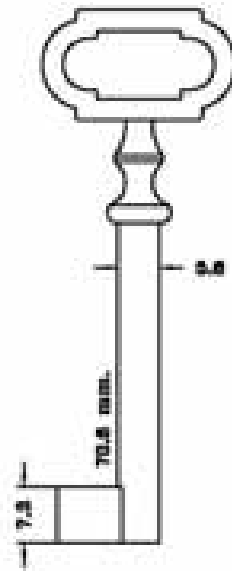

13.5
#3.00
Y-1G Y-1G CV

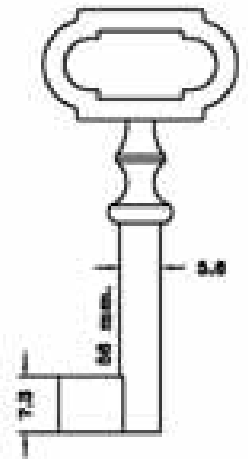

13.5
#3.00
V-2G V-2G CV

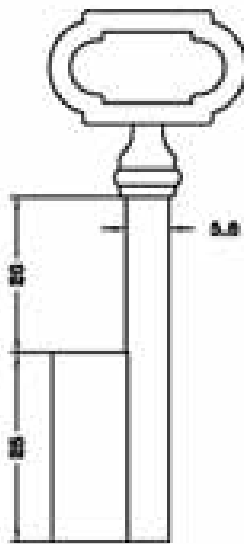

19.5
#4.00
V-3G V-3G CV

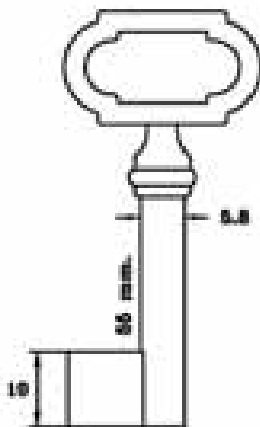

19.5
#4.00
V-4G CV

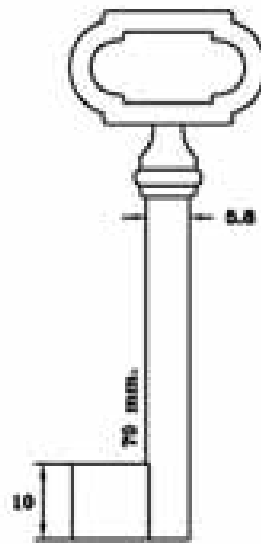

19.5
#4.00
V-5G CV

Copyright by
Alejandro Allina S.A.
1978

JMA

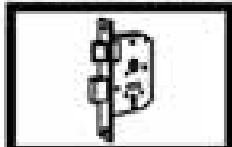

322

LLAVES ARTÍSTICAS Y DE ARMARIO ZAMAK

ZAMAKEZKO GILTZAK: ARMAIRUETARAKO ETA ARTISTIKOAK

ZAMAK FURNITURE KEYS





CLÉS POUR MEUBLES EN ZAMAK

MOBELSCHLÜSSEL AUS ZAMAK

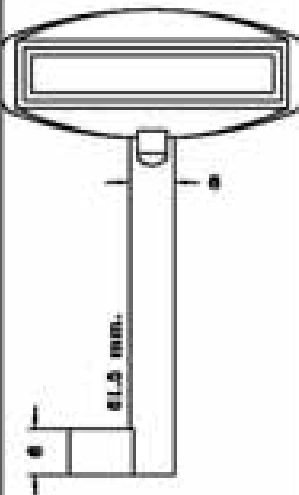
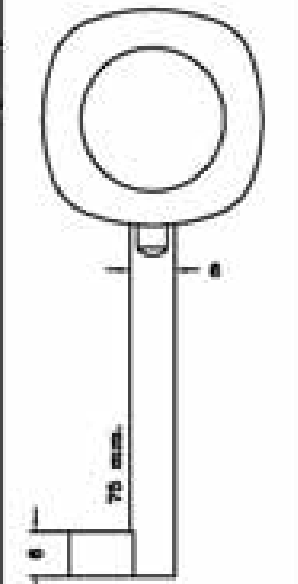
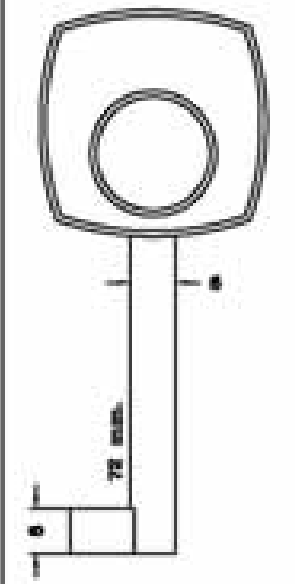
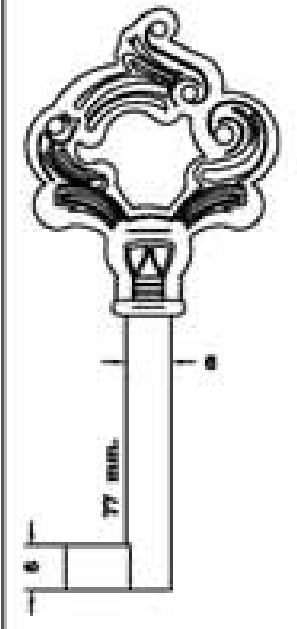

THE KEY TO EXCELLENCE
GLOBALLY UNLOCKING MILLIONS OF DOORS DAILY

PARA-FOR:

 <p>81.5 mm.</p>	 <p>75 mm.</p>	 <p>78 mm.</p>	 <p>77 mm.</p>
 <p>A1 LAT. A1 NIQ.</p>	 <p>D1 LAT. D1 NIQ.</p>	 <p>E1 LAT. E1 NIQ.</p>	 <p>F1 LAT. F1 NIQ.</p>

Copyright by
Alejandro Allina S.A.
2018

JMA

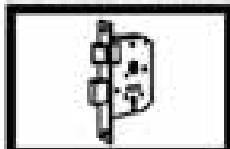

324

LLAVES PARA CASILLAS Y ASCENSORES

KUTXATILA ETA IGOGAILUENTZAKO GILTZAK

LIFT AND MAIL BOX KEYS

CLÉS POUR ASCENSEURS ET BOITES A LETTRES

FACHKASTEN-UND LIFTSSCHLÜSSEL



THE KEY TO EXCELLENCE

GLOBALLY UNLOCKING MILLIONS OF DOORS DAILY

PARA-FOR:

DIEBOLD (D)

RIL (E)

SERRETA (E)

URKO (E)

YALE (D-GB)

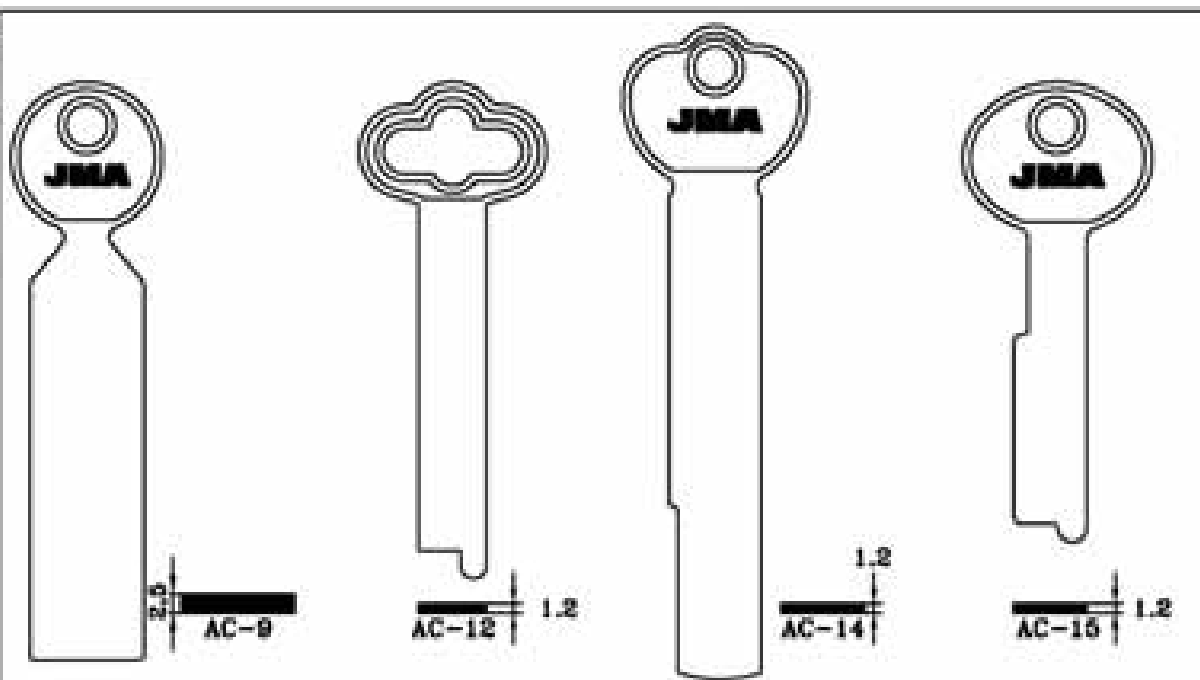

PARA-FOR: DIEBOLD	RIL	SERRETA	URKO
<p style="text-align: center;">DIE-1</p>	<p style="text-align: center;">28-M</p>	<p style="text-align: center;">7-S</p>	<p style="text-align: center;">URKO-4</p>

PARA-FOR: YALE

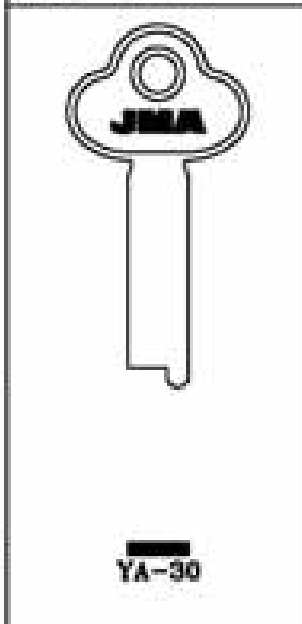

Copyright by
Alfonso Allina S.A.
2018

JMA

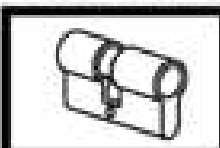

326

AUTOMÓVIL - CAMIONETA

AUTOMOBILA-KAMIONETA

CAR-PICK UP TRUCK

VOITURE-CAMIONNETTE

AUTO-KLEINTRANSPORTER





THE KEY TO EXCELLENCE
GLOBALLY UNLOCKING MILLIONS OF DOORS DAILY



AUTOMÓVIL - CAMIONETA



CAR - PICK-UP TRUCKS



AUTOMÓVIL-CAMIONETA

AUTOMOVILA-KAMIONETA • CAR-PICK-UP TRUCKS
VOITURE-CAMIONNETTE • AUTO-KLEINTRANSPORTER

MARCA BRAND	MODELO MODEL			
AST	GOLF 3	1991-	AU-AH AU-AHP	AU-AH AU-AHP
			VO-2 VO-2KP VO-2P	VO-2 VO-2KP VO-2P
ACM	18.1 ENDURO	-	NE-15I	RO-15
	18.4 ENDURO	-	NE-15IP	
	OFF 4WD	-		
ACURA (HONDA)	INTEGRA	-1989	HOND-18	HOND-19
	LEGEND	1989-1991	HOND-18P	HOND-19P
	MOODIUS-MOORLS	1986-1988		
	INTEGRA	1999-	HOND-15	HOND-15
	VIGOR	1992-	HOND-15P	HOND-15P
	LEGEND	1991-	HOND-17P	HOND-17P
	NSX	1991-1997	HOND-16D HOND-16DP HOND-16DP1	HOND-16D HOND-16DP HOND-16DP1
ALFA ROMEO	12 AR 6	-	FI-12	FI-12
	13 AR 6	-	FI-12P FI-12P3 FI-3D FI-3DP3 FI-6I FI-6IP4	FI-12P FI-12P3 FI-3D FI-3DP3 FI-6I FI-6IP4
	30 AR 8	-1986	AF-7I	IMS-3
	35 AR 8	-1986	AF-7IP	IMS-3P
	40 AR 8	-1986	FI-6I FI-6IP	IMS-5 IMS-5P
	30 AR 8	1986-	FI-2D	FI-2D
	35 AR 8	1986-	FI-2DP3	FI-2DP3
	40 AR 8	1986-	FI-3D FI-3DP1 FI-6I FI-6IP1	FI-3D FI-3DP1 FI-6I FI-6IP1
	33	1983-1986	AF-14	AF-14
	164	1987-1995	AF-18P	AF-14P
	164 V6	1987-1995	FI-6I FI-6IP4	FI-6I FI-6IP4
	33	1986-1998	FI-2D	FI-2D
	75 TD	1987-	FI-3DP4	FI-3DP4
	33	1998-	AF-14	AF-14
	75	1988-1991	AF-18P	AF-14P
	SZ COUPE	1991-		
	75 MILANO	1985-	AF-13	AF-13
	99	1985-	AF-13P	AF-13P
	SPIDER	1991-1995		
	99	1984-1985	FI-6I FI-6IP4	FI-6I FI-6IP4
	145	1994-	FI-13 FI-13P	FI-13 FI-13P
	166	1992-1995	FI-13	FI-13
	155 6V	1992-1995	FI-13P	FI-13P



MARCA BRAND	MODELO MODEL			
ALFA ROMEO	155 T.S.	1992-1995	FI-14P	FI-14P
	1750	-	AF-7I	AF-5D
	GIULIA 1300	-	AF-7IP	AF-5I
	GIULIA 1600	-	NE-25	AF-6D AF-6I
	2000 BERLINA	-	AF-7I	AF-5D
	A 11 D	-	AF-7IP	AF-5I
	A 12 D	-		AF-6D
	ALFETTA 1.6 I	-		AF-6I
	ALFETTA 1.8 I	-		
	F 11 D	-		
	F 12 D	-		
	GIULIA DIES.	-		
	SPIDER 1300	-		
	SPRINT	-		
	2000 COUPE	-	SIP-3	AF-5D AF-5I AF-6I
	2000 SPIDER	-		
	A 11	-		AF-5D
	A 12	-		AF-5I
	F 11	-		AF-6D
	F 12	-		AF-6I
	A 39	-	BH-1	RO-7D
	A 39	-	BH-1P	
	ALFA G	1984-	FI-6I	AF-10
	ALFETTA	1982-1984	FI-6IP4	AF-11 AF-12
	ALFASUD	-	AF-7I AF-7IP FI-6I FI-6IP4 FI-6I FI-6IP SIP-3	AF-5D AF-5I AF-6D AF-6I
	ALFETTA	1979-1982	AF-7I	AF-10
	ALFETTA 1.6 2	-	AF-7IP	AF-11
	ALFETTA 1.6 G	-		AF-12
	ALFETTA 1.8 2	-		
	ALFETTA 1.8 G	-		
	ALFETTA 2.0 G	-		
	GIULIETTA	1979-1981		
	ALFETTA	1984-	FI-6I FI-6IP4	AF-10 AF-11 AF-12 FI-6I FI-6IP4
	ARNA 1.2 L	-	FI-6I	DAT-6
	ARNA 1.2 LS	-	FI-6IP4	DAT-6P
	ARNA 1.3 TI	-		
	QUETTO	-	FI-6I FI-6IP4	AF-5D AF-5I

MARCA BRAND	MODELO MODEL				
ALFA ROMEO				AF-60 AF-61	
	GIULIETTA	1981-	FI-61	GI08-3P	
	GTV 2.0	1982-1995	FI-60P		
	GTV 2.0 HV	1984-1995			
	GTV 2.5	1982-1995			
	GTV 2.5 HV	1984-1995			
	MONTRÉAL	-	AF-71 AF-72P	BMS-3 BMS-3P BMS-5 BMS-5P	
	SPIDER	1976-1989	AF-71 AF-72P FI-61 FI-60P SIP-3	AF-50 AF-51 AF-60 AF-61	
	SPIDER	1990-1991	AF-14 AF-14P	AF-50 AF-51 AF-60 AF-61	
	AMERICAN MOTORS	ALLIANCE	1981-1983	CHR-3	NE-16
		ENCORE	1981-1983	CHR-3P	NE-50P VA-10
		ALLIANCE	1984-1995	CHR-3	NE-16
		ENCORE	1984-1995	NE-19 NE-19P NE-22P	NE-50P VA-10
		ALLIANCE	1985-1986	CHR-3	BAS-11
		ENCORE	1985-1986	NE-22P	
ALLIANCE		1986-1988	NE-19	BAS-11	
ENCORE		1986-1988	NE-19P		
CHEROKEE		-1990	BAS-11	BAS-11	
COMANCHE		-1990	GM-9		
W.BASE		-1990	GM-9P		
W.ISLANDER		-1990	GM-J		
W.LAREDO		-1990	GM-JP		
W.SAHARA		-1990			
W.TEXAS		-1990			
WAGONER		-1990			
CHEROKEE		1991-1992	CHR-9	CHR-9	
COMANCHE		1991-1992	CHR-9P	CHR-9P	
MJ COMANCHE		1993-	CHR-18	CHR-18	
XJ CHEROKEE		1993-	CHR-18P	CHR-18P	
YJ WRANGLER		1993-			
ZJ GLCHEROKEE		1993-			
MODELOS - MODELS		1993-1999	BS-11	BS-11	
MODELOS - MODELS		1970-1995	BAS-11	BAS-11	
WAGONER		1991-1992	CHR-9 CHR-9P GM-9 GM-9P GM-J GM-JP	BAS-11 CHR-9 CHR-9P	
ARNO DACIA		203	-	BR-1 BR-1P	HU-1 RO-15
		240	1982-1985	BR-1 BR-1P	RO-15
		240	1985-	NE-15J	RO-15
	241	1985-	NE-15MP1		



MARCA BRAND	MODELO MODEL			
ARNO DACIA	242	1985-		
	243	1985-		
	244	1985-		
	ISCHIA 10.1	1985-		
	ISCHIA 10.4	1985-		
	SUPER ISCHIA	1985-		
ASTON MARTIN	LAGONDA	-	FO-LTC	FO-LTC
	LAGONDA LIM.	-	FO-LTCP	FO-LTCP
	VE SALOON	-	FO-FR	IN-1
	VE VANTAGE	-	FO-FRP	OP-WHP
	VE VANTAGE Z	-	OP-WHP	OP-WYP
	VE VOLANTE	-	OP-WYP	UN-1P UN-1S UN-1T
	VE VOLANTE C	-		
AUDI	50 GL	1974-	VO-V8	VO-V8
	50 LS	1974-	VO-V8P	VO-V8P
	80 GLS	1979-		
	80 GT	1979-		
	80	1979-1982	AU-1	AS-1
	100	1979-1982	AU-HV	AS-HV
	200	1979-1982	AU-HVP	AS-HVP
	4000	1979-1982	VO-3KP	VO-3KP
	5000	1979-1982	VO-V8 VO-V8P	VO-V8 VO-V8P
	80	1983-1984	AU-1 AU-HV AU-HVP1 VO-3KP VO-HV VO-V8 VO-V8P	AS-1 AS-HV AS-HVP1 VO-3KP VO-HV VO-V8 VO-V8P
	80	1984-1985	AU-AH	AS-AH
	QUATTRO	1984-1985	AU-AHP1 AU-AN AU-ANP VO-2 VO-3KP VO-2P	AS-AHP1 AS-AN AS-ANP VO-2 VO-3KP VO-2P
	80	1985-	AU-AH	AS-AH
	90	1985-	AU-AHP	AS-AHP
	100	1985-	AU-AN	AS-AN
	200	1985-	AU-ANP	AS-ANP
	4000	1985-	VO-2	VO-2
	5000	1985-	VO-3KP	VO-3KP
	CARRIO	1985-1995	VO-2P	VO-2P
	COUPE	1985-1995		
	QUATTRO	1985-		
	V8	1985-		
	100	1979-	NE-1	AS-W
100 GLS	1979-	NE-1P		
100 L	1979-			
COUPE GT	1982-1984	AU-1	AS-1	
QUATTRO	1982-1984	AU-HV AU-HVP VO-3KP VO-HV VO-V8 VO-V8P	AS-HV AS-HVP VO-3KP VO-HV VO-V8 VO-V8P	
FOX	1972-1977	VO-3KP	VO-3KP	



AUTOMÓVIL - CAMIONETA

CAR - PICK-UP TRUCKS

MARCA BRAND	MODELO MODEL			
AUDI			VO-HV	VO-HV
			VO-HVP	VO-HVP
AUSTIN	SHERPA 105	-	LF-8L	UN-1PS
	SHERPA 230	-	LF-8D	UN-1T
	SHERPA 255	-	LF-8OP	
AUTOBIANCHI	A111	-	AF-7I	IMS-3
			AF-7IP	IMS-3P
			AF-8D	IMS-5
			AF-8DP	IMS-5P
			AF-8I	
			AF-8IP	
			AF-9D	
			AF-9DP	
			AF-9I	
			AF-9IP	
A112	1971-1977		AF-7I	IMS-3
			AF-7IP	IMS-3P
			FI-9I	IMS-5
			FI-9IP	IMS-5P
			SIP-3	
A112	1978-1981		AF-7I	IMS-3
			AF-7IP	IMS-3P
			FO-7B	IMS-5
			FO-7BP	IMS-5P
A112	1981-1984		AF-7I	IMS-3
			AF-7IP	IMS-3P
			FI-8I	IMS-5
			FI-8IP	IMS-5P
			FI-9I	
			FI-9IP	
A112	1984-1986		FI-3D	FI-3D
			FI-3DP3	FI-3DP3
			FI-4I	FI-4I
			FI-4IP3	FI-4IP3
				IMS-3
				IMS-3P
				IMS-5
				IMS-5P
A112 (3.SER)	1969-1971		AF-7I	IMS-3
			AF-7IP	IMS-3P
			AF-8D	IMS-5
			AF-8DP	IMS-5P
			AF-8I	
			AF-8IP	
			AF-9D	
			AF-9DP	
			AF-9I	
			AF-9IP	
			FO-7B	
			FO-7BP	
BIANCHINA	-		FEM-10	AF-4D
			FEM-11	AF-5I
			FEM-20	AF-4D
			FEM-21	AF-4I
PRIMULA	-		AF-7I	
			AF-7IP	
			FEM-10	
			FEM-11	
			FEM-20	



MARCA BRAND	MODELO MODEL			
AUTOBIANCHI			FEM-21	
	Y18	Y18-	FI-1	FI-1
			FI-11	FI-11
			FI-11KP	FI-11KP
			FI-11P	FI-11P
			FI-1P	FI-1P
			FI-1P9	FI-1P9
BEIJING	MIDI VAN	-	TOYO-14	TOYO-14
	MIDI WAGON	-	TOYO-14P	TOYO-14P
	WINDOW VAN	-		
	RASCAL	-	GM-1P	GM-1P
BENTLEY	CONTINENTAL	-	YA-18D	YA-18D
	EIGHT	-	YA-19D	YA-19D
	TURBO	-		
	MULSANNE	1987-	YA-20I	YA-20I
			YA-21I	YA-21I
BIESTONE	FIRECLIMBER	-	DAI-1P	DAI-1P
	SL-CARRIO	-	MIT-12	MIT-12
			MIT-7	MIT-7
			MIT-7P	MIT-7P
BMW	AMICA 250	-	AF-10	UN-MEN
	AMICA 300 0	-	AF-10P	
	AMICA M-125	-	AF-11	
			AF-11P	
			FEM-11	
BMW	L34 TD	1984-1986	BM-2	BM-2
	SERIE 7	1984-1986	BM-2P	BM-2P
			BM-HB	BM-HB
			BM-HBP	BM-HBP
	1502	1969-1976	BM-W	BM-8
	1600	1969-1976		HB-5X
	1602	1969-1976		
	1800	1969-1976		
	1802	1969-1976		
	2000	1969-1976		
	2002	1969-1976		
	2000 TOURING	1969-	BM-W	BM-W
	2002 TOURING	1979-		
	2500	1969-	BM-1P	BM-1P
	2800	1979-1975		
	3000	1979-1975		
	3000	1979-1975		
	BAVARIA	1979-1975		
	SERIE 3	1975-1984	BM-3	BM-3
	SERIE 5	1975-1984	BM-3P	BM-3P
	SERIE 6	1975-1984	BM-HB	BM-HB
	SERIE 7	1975-1984	BM-HBP	BM-HBP
			BM-NB	BM-NB
			BM-NBP	BM-NBP
	SERIE 3	1987-1990	BM-2	BM-2
			BM-2P	BM-2P
			BM-NB	BM-NB
			BM-NBP	BM-NBP
	SERIE 3	1989-1995	BM-4	BM-4
	SERIE 5	1989-1995	BM-5P	BM-5P
	SERIE 7	1989-1995		
	SERIE 8	1989-1995		
CANONICAL	FAIRWAY FX85	-	LF-8D	IN-4
			LF-8OP	IN-5



MARCA BRAND	MODELO MODEL			
CHRYSLER	BM	1987-	CHR-8	CHR-8
	LTJ AVENUE	-	CHR-8P	CHR-8P
	FULL SIZE V.	-		
	LEBARON	1989-		
	NEW YORKER	-		
	ARROW	-	MIT-11	MIT-11
	D 54	-	MIT-11P	MIT-11P
	PICK UP	-		
	CHALLENGER	-	MIT-21	MIT-21
	CONQUEST	-	MIT-21P	MIT-21P
	RAIDER	-		
	SAPPORO	-		
	COLT	1993-	MIT-80	MIT-80
	VISTA	1993-	MIT-80P	MIT-80P
	CONCORDE	1993-	CHR-18	CHR-18
	FULL SIZE V.	1993-	CHR-18P	CHR-18P
	IMPERIAL	1993-		
	NEW YORKER	1993-		
	PICK UP	1993-		
	TOWN & CO.	1993-		
	VANS	-		
	CRICKET	-	LF-SL	LF-SL
			LF-SLP	LF-SLP
	GIL VOYAGER	1990-1997	CHR-14	CHR-14
	STRATUS	1995-	CHR-14P	CHR-14P
	VIPER	1995-	CHR-15	CHR-15
	VISION	1995-	CHR-15P	CHR-15P
	VOYAGER	1995-		
	LEBARON VAN.	-	CHR-7	CHR-7
	MOD. USA	1967-1979	CHR-7P	CHR-7P
	MOD. USA	1980-1986		
	OMNI-HORIZON	-		
RELIANT	1989-			
TCI-ARIES	-			
CHRYSLER (DODGE)	400	1985-	CHR-7	CHR-7
	DODGE	1985-1986	CHR-7P	CHR-7P
	RAM 50	-		
	800 CARMEL	1985-1989	CHR-8	CHR-8
	CARAVAN	1991-1993	CHR-8P	CHR-8P
	DAKOTA	1991-1993		
	DAYTONA	1991-1993		
	DODGE	1986-1999		
	LANCER	-		
	RAM	1986-		
	SHADOW ES	1991-1992		
	TRAIL DUSTER	1986-		
	CARAVAN	1993-	CHR-18	CHR-18
	DAKOTA	1993-	CHR-18P	CHR-18P
	DAYTONA	1993-		
	INTREPID	1993-		
	RAMCHARGER	1993-		
	SPIRIT	1993-		
	VIPER	1993-		
	COLT	1989-1993	CHR-17	CHR-17
	VISTA	1989-1992	MIT-12	MIT-12
			MIT-7	MIT-7
			MIT-7P	MIT-7P
	COLT	1993-	MIT-130	MIT-130
	VISTA	1993-	MIT-140	MIT-140



MARCA BRAND	MODELO MODEL			
CHRYSLER (DODGE)			MIT-80	MIT-80
			MIT-80P	MIT-80P
	DODGE	-	CHR-7	CHR-7
	RAMCHARGER	1981-1992	CHR-7P	CHR-7P
			CHR-8	CHR-8
			CHR-8P	CHR-8P
	DODGE	1991-	CHR-9	CHR-9
	NEON	1995-	CHR-9P	CHR-9P
	SPIRIT	1996-1992		
	VIPER	1996-1992		
	DODGE 400	1985-	CHR-7	
			CHR-7P	
	DODGE 600	1989-	CHR-8	
			CHR-8P	
	MONACO	1999-1993		VA-18
	STEALTH	1991-1993	MIT-12	MIT-12
			MIT-7	MIT-7
			MIT-7P	MIT-7P
	D 54	-	MIT-11	MIT-11
	EAGLE	-	NE-19	NE-28
MEDALLION	-	NE-19P	VA-18	
EAGLE	1989-1998	MIT-12	MIT-12	
		MIT-7	MIT-7	
		MIT-7P	MIT-7P	
EAGLE	1994-1992		VA-18	
PREMIER	1994-			
EAGLE	1993-	MIT-80	MIT-80	
		MIT-80P	MIT-80P	
SUMMIT	1993-1992	CHR-17	CHR-17	
TALON	1989-	MIT-12	MIT-12	
		MIT-7	MIT-7	
		MIT-7P	MIT-7P	
SUMMIT	1993-	MIT-130	MIT-130	
		MIT-140	MIT-140	
		MIT-80	MIT-80	
		MIT-80P	MIT-80P	
VISION	1993-1998	CHR-18	CHR-18	
		CHR-18P	CHR-18P	
CHRYSLER (PLYMOUTH)	ACCLAIM	1994-1992	CHR-9	CHR-9
	PLYMOUTH	1989-	CHR-9P	CHR-9P
	ACCLAIM	1993-	CHR-16	CHR-16
	GRAN VOYAGER	1993-	CHR-16P	CHR-16P
	VOYAGER	1993-		
	COLT VISTA	1989-1992	CHR-17	CHR-17
	LASER	1989-1992		
	COLT VISTA	1993-1994	MIT-130	MIT-130
			MIT-140	MIT-140
	NEON	1995-	CHR-14	CHR-14
			CHR-14P	CHR-14P
			CHR-15	CHR-15
		CHR-15P	CHR-15P	
PLYMOUTH	1985-1986	CHR-7	CHR-7	
		CHR-7P	CHR-7P	
PLYMOUTH	1986-1998	CHR-8	CHR-8	
SUNDANCE	1989-	CHR-8P	CHR-8P	
VOYAGER	1991-1992			
CITROEN	2 CV	1979-	CT-3	LAS-P
			CT-3P	RO-40
			CT-4P	RO-41



AUTOMÓVIL - CAMIONETA

CAR - PICK-UP TRUCKS

MARCA BRAND	MODELO MODEL			
CITROËN	ACADIANE	-	CT-3P1	RO-4D
			CT-3	RO-4I
			CT-3P	
	AMIE	1969-	CT-3	RO-5D
	AMIE	1969-	CT-3P	RO-6I
	SM	1970-		
	AZ	1986-1989	CL-8P	CL-8P
	BX	1982-1990	SIX-1	SIX-1
			SIX-1KP	SIX-1KP
			SIX-1P	SIX-1P
			SIX-2	SIX-2
			SIX-2P	SIX-2P
	AX	1989-1994	NE-36	NE-36
			NE-36KP1	NE-36KP1
			NE-36P1	NE-36P1
			SIX-1	SIX-1
			SIX-1KP	SIX-1KP
			SIX-1P	SIX-1P
			SIX-2	SIX-2
			SIX-2P	SIX-2P
	AX	1994-	NE-36P3	NE-36P3
	ZX	1994-	NE-36	NE-36
	AX	1995-	SIX-3P2	SIX-3P2
	ZX	1995-		
	AX 14D COME	-	SIX-1	SIX-1
			SIX-1KP	SIX-1KP
			SIX-1P1	SIX-1P1
	AXEL	1994-	CHR-3	CHR-3
			CHR-3P	CHR-3P
			NE-22P1	NE-22P1
	BERLINGO	1997-	SIX-3P1	SIX-3P1
	EVASION	1994-		
	JUMPI	1990-		
	BX	1998-	NE-36	NE-36
			NE-36KP1	NE-36KP1
			NE-36P1	NE-36P1
			SIX-1	SIX-1KP
			SIX-1KP	SIX-1P
			SIX-1P	SIX-2
			SIX-2	SIX-2P
		SIX-2P		
C-15 B	-	SIX-1	SIX-1	
C-15 E	-	SIX-1KP	SIX-1KP	
VISA	1985-	SIX-1P	SIX-1P	
ZX	1991-1992			
C-25 FURGON	-	FI-6I	FI-6I	
		FI-6P3	FI-6P3	
CX	1974-1985	CT-3	AB-5D	
		CT-3P	AB-6I	
			RO-5D	
			RO-6I	
CX	1985-	SIX-1	SIX-1	
		SIX-1KP	SIX-1KP	
		SIX-1P	SIX-1P	
		SIX-2	SIX-2	
		SIX-2P	SIX-2P	
D	-1974	CT-1	RO-5D	
DS	-1974	CT-1P	RO-6I	
		CT-3		



MARCA BRAND	MODELO MODEL			
CITROËN	DYANE	1967-1988	CT-3	RO-4D
			CT-3P	RO-4I
			CT-3P1	
			CT-3	
			CT-3P	
	DYANE	1989-	SIX-1	RO-4D
			SIX-1KP	RO-4I
			SIX-1P	
			SIX-2	
			SIX-2P	
	G	1979-	CT-3	AB-5D
	GS	1979-	CT-3P	RO-5D
	GSA	1979-		RO-6I
	JUMPER	1990-	FI-11P	FI-11P
	LN	1976-1984	NE-4	VA-6
	LNA	1976-1984	NE-4P1	VA-6P
	LNA	1984-	CHR-3	VA-6
			CHR-3P	VA-6P
			NE-22P1	
	MUHARI	1983-	CT-3	RO-4D
			CT-3P	RO-4I
			CT-4P	
	PLUS	-	FI-12	FI-12
			FI-12P	FI-12P
			FI-12P3	FI-12P3
			FI-3D	FI-3D
			FI-3DP3	FI-3DP3
	SAXO	1996-	SIX-3P	SIX-3P
	XANTIA	1993-		
	XM	1999-		
	VISA	1975-1985	CHR-3	RO-4D
			CHR-3P	RO-4I
			NE-22P1	RO-5D
			NE-4	RO-6I
			NE-4P1	
	ZX	1992-1994	SIX-1KP	SIX-1KP
			SIX-1P2	SIX-1P2
	DAEWOO	DAEW	DAE-1P	DAE-1P
	LANOS	1997-	DAE-4P1	DAE-4P1
	LE MANS	1973-1982	OP-6	OP-6
		OP-7	OP-7	
		OP-8	OP-8	
		OP-9	OP-9	
		OP-8B	OP-8B	
		OP-EE	OP-EE	
		OP-FF	OP-FF	
LE MANS	1983-1984	OP-D	OP-D	
		OP-DKP	OP-DKP	
		OP-DP	OP-DP	
		OP-S	OP-S	
		OP-SKP	OP-SKP	
		OP-SP	OP-SP	
LE MANS	1985-	OP-AB	OP-AB	
		OP-ABP	OP-ABP	
		OP-BA	OP-BA	
		OP-BAP	OP-BAP	
		OP-J	OP-J	
		OP-JP	OP-JP	



MARCA BRAND	MODELO MODEL				
DAEWOO	LEGANZA	1997-	DAE-4DP1	DAE-4DP1	
	NUBIRA	1997-	DAE-3DP1	DAE-3DP1	
	RACER	-	DAE-2DP	DAE-2DP	
DAF	46 L	-		FO-TC	
	46 STATIONCA	-			
	46 SUPER L	-			
	66 GL	-			
	95 XT	1997-	CHR-3P	CHR-3P	
DAIHATSU	4 WD TURBO	-	TOYO-K1		
	PIONEER 2000	-	TOYO-K1P		
	TAFT 1600 D.	-			
	TAFT F18	-			
	TAFT F20	-			
	TAFT F201000	-			
	TAFT F50	-			
	TAFT F55	-			
	APPLAUSE	1998-	DAI-1P	DAI-1P	
	CHARADE	1999-			
	FEROZA	1998-			
	ROCKY	1998-			
	SPORTTRACK	1991-			
	SX 220	1991-			
	CHARADE	1977-1983	TOYO-K1	TOYO-K1	
	CHARMANT	1983-	TOYO-K1P	TOYO-K1P	
	COORE L55	1976-1999			
	COORE L60	1976-1998			
	MIRA	1976-			
	CHARADE	1983-1989	TOYO-3	TOYO-3	
	FOURTRAK 4WD	1984-1988	TOYO-3P	TOYO-3P	
	ROCKY	1984-1988	TOYO-8	TOYO-8	
			TOYO-8P	TOYO-8P	
	COORE 8M	1986-1991	TOYO-3	TOYO-3	
	ROCKY	1989-1998	TOYO-3P	TOYO-3P	
	DAIMLER	DOUBLE SIX C	-1987	FO-FB	CMT-3D
		LIMOUSINE	-1987	FO-FRP	FO-5
SOVEREIGN V.		-1987			
SOVEREIGNLA		-1987			
SOVEREIGNLJ		-1987			
MODUL0 - MODELS		1989-1994	JAU-1P	JAU-1P	
MODUL00 - MODELS		1989-1981	NE-1B	LF-WB	
DELTA MOTOR	CRUISER	-	TOYO-K1	TOYO-K1	
	MINI WHEEL	-	TOYO-K1P	TOYO-K1P	
	EXPLORER	-	TOYO-K1	DAT-6	
DISALCAR	IN 32 4X4	-	AF-7I	IMS-3	
	IN 50 B 4X4	-	AF-7IP	IMS-3P	
	IN 60 4X4	-		IMS-5	
	IN 70 B 4X4	-		IMS-5P	
	IN 70 CB 4X4	-			
	R 26 4x4	-	BR-4		
EBRO	F 275	-	LMP-1	IMS-3	
	F 260	-	LMP-1P	IMS-3P	
			STS-2D	IMS-5	
			STS-2DP	IMS-5P	
	L 35	-	LMP-1	CL-2I	
	L 35/1	-	LMP-1P	CL-3I	
	L 60	-	NE-3	FO-0A	
	L 80	-	NE-3P	FO-PN	



MARCA BRAND	MODELO MODEL				
EBRO			NE-3P1		
			NE-3P2		
	PATROL	1980-	DAT-6	DAT-6	
	VANETTE	1980-	DAT-6P	DAT-6P	
	TRADE 2.0	1980-	STS-2D	IMS-3	
	TRADE 2.8	1980-	STS-2DP	IMS-3P	
FERRARI				IMS-5	
				IMS-5P	
	288	1975-1982	NE-25	IMS-3	
	308	1973-1975		IMS-3P	
	305	1988-		IMS-5	
	DINO 206	-		IMS-5P	
	288	1987-	NE-25	AF-5D	
	308	1975-		AF-5I	
	328	1985-		AF-6D	
				AF-6I	
	288 GTS	1982-	AF-7IP1		
	348	1984-	FI-6I	FI-6I	
	F 40	1984-	FI-6IP	FI-6IP	
	MONDIAL	1984-	FI-6IP2	FI-6IP2	
	TESTA ROSSA	1984-	FI-6IP3	FI-6IP3	
	400	1976-	HU-1	AF-5D	
	412	1976-	NE-25	AF-5I	
	BB 512	1976-		AF-6D	
				AF-6I	
	GTO	1984-	NE-25	AF-6D	
	MONDIAL II	1982-	AF-7I	AF-5D	
			AF-7IP	AF-5I	
			AF-7IP1	AF-6D	
				AF-6I	
	FIAT	124	1986-	AF-7I	IMS-3
				AF-7IP	IMS-3P
				AF-9D	IMS-5
			AF-9DP	IMS-5P	
			REM-1D		
			REM-1I		
			REM-2D		
			REM-2I		
			FO-FB		
			FO-FRP		
			SIP-2		
125		-	AF-7I	IMS-3	
			AF-7IP	IMS-3P	
			AF-9D	IMS-5	
			AF-9DP	IMS-5P	
		FO-FB			
		FO-FRP			
126	-	AF-7I	IMS-3		
		AF-7IP	IMS-3P		
		AF-9D	IMS-5		
		AF-9DP	IMS-5P		
		FI-3D			
		FI-3DP2			
		FI-6I			
		FI-6IP			
		FO-FB			
		FO-FRP			
		SIP-3			
126 805	1987-1992	FI-3D	IMS-3		



AUTOMÓVIL - CAMIONETA

CAR - PICK-UP TRUCKS

MARCA BRAND	MODELO MODEL			
FIAT	126 UP	1987-1992	FI-30P2	IMS-3P
			FI-30P3	IMS-5
			FI-41	IMS-5P
			FI-60P2	
	127	1973-	AF-71	IMS-3
			AF-71P	IMS-3P
			FI-81	IMS-5
			FI-81P	IMS-5P
			FI-91	
			FI-91P	
FO-7B				
FO-7BP				
127	1983-	AF-71P1		
		FI-81P1		
128	1969-	AF-71	IMS-3	
		AF-71P	IMS-3P	
		AF-9D	IMS-5	
		AF-9DP	IMS-5P	
		FI-91		
		FI-91P		
		FO-7B		
		FO-7BP		
130	1969-	AF-71	IMS-3	
		AF-71P	IMS-3P	
		SIP-2	IMS-5	
			IMS-5P	
131	1973-1988	AF-71	IMS-3	
		AF-71P	IMS-3P	
		AF-81	IMS-5	
		AF-81P	IMS-5P	
		AF-91		
		AF-91P		
131	1981-	FI-2D	FI-3D	
		FI-2DP3	FI-3DP2	
		FI-3D	FI-41	
		FI-3DP2	FI-41P	
		FI-61	FI-61P	
132	1973-	AF-71	IMS-3	
		AF-71P	IMS-3P	
		FI-81	IMS-5	
		FI-81P	IMS-5P	
147	1976-	FI-81	IMS-3	
148	1976-	FI-81P	IMS-3P	
		FI-81P1	IMS-5	
		FI-91	IMS-5P	
		FI-91P		
500	1964-	AF-9D	AF-1D	
		AF-9DP	AF-51	
		FEM-1D	AF-4D	
		FEM-11	AF-61	
		FEM-2D		
		FEM-21		
		FO-7B		
		FO-7BP		
600	1961-	FEM-1D	AF-1D	



MARCA BRAND	MODELO MODEL			
FIAT	1300	-	FEM-11	AF-51
			FEM-2D	AF-6D
			FEM-21	AF-61
850	1964-	AF-71	AF-5D	
		AF-71P	AF-51	
		FEM-1D	AF-6D	
		FEM-11	AF-61	
		FEM-2D		
		FEM-21		
		FO-7B		
		FO-7BP		
1100	1964-	FEM-1D	AF-4D	
		FEM-11	AF-41	
		FEM-2D	AF-5D	
		FEM-21	AF-51	
			AF-6D	
1100	1967-	FEM-1D	AF-5D	
		FEM-11	AF-51	
		FEM-2D	AF-6D	
		FEM-21	AF-61	
		SIP-2		
1800	1967-	SIP-2	AF-6D	
2100	1967-		AF-51	
2300	1967-		AF-6D	
			AF-61	
ARGENTA	1981-	FI-2D	FI-2D	
		FI-2DP3	FI-2DP3	
		FI-3D	FI-3D	
		FI-3DP2	FI-3DP2	
CINQUECENTO	1982-1987	FI-11	FI-11	
DOCATO	1984-	FI-11KP	FI-11KP	
		FI-11P	FI-11P	
COUPE	1984-1985	FI-13	FI-13	
TIPO	1988-	FI-13P	FI-13P	
CROMA	1985-1985	FI-18	FI-11	
		FI-18P	FI-11KP	
		FI-11	FI-11P	
		FI-11KP		
		FI-21P		
DINO	-	FO-7B	IMS-3	
		FO-7BP	IMS-3P	
		SIP-2	IMS-5	
			IMS-5P	
DUNA	1987-1991	FI-1	FI-1	
PANDA	1986-1991	FI-1P	FI-1P	
RITMO	1984-1986			
STRADA	1984-1986			
DUNA	1982-	FI-1	FI-1	
PANDA	1982-1985	FI-11	FI-11	
UNO	1983-	FI-11KP	FI-11KP	
		FI-11P	FI-11P	
		FI-1P	FI-1P	
FORNO	-	AF-71	IMS-3	
		AF-71P	IMS-3P	
		AF-9D	IMS-5	



MARCA BRAND	MODELO MODEL			
FIAT			AF-50P	BMS-5P
			AF-61	
			AF-50P	
			FI-61	
			FI-60P	
			FI-61	
			FI-50P	
	PANDA	1980-1985	FI-71	BMS-3
			FI-61	BMS-3P
			FI-60P	BMS-5
			FI-60P1	BMS-5P
			FI-61	
			FI-50P	
	PUNTO	1993-1995	FI-13	FI-13
			FI-13P1	FI-13P1
	REGATA	1983-	FI-1	FI-1
			FI-18	FI-11
			FI-18P	FI-11KP
			FI-11	FI-11P
			FI-11KP	FI-1P
			FI-11P	
			FI-1P	
	BITMO	1976-1983	FI-30	FI-30
			FI-30P	FI-30P
			FI-30P2	FI-30P2
			FI-61	FI-61
			FI-60P	FI-60P
	SCUDO	1995-1997	SIX-3P1	SIX-3P1
ULYSSE	1994-			
SPIDER EURO.	-	AF-71	AF-50	
		AF-70P	AF-51	
			AF-60	
			AF-61	
STRADA	1979-1982	FI-71	FI-71	
		FI-61	FI-61	
		FI-60P	FI-60P	
STRADA	1982-1984	FI-30	FI-30	
		FI-30P	FI-30P	
		FI-61	FI-61	
		FI-60P	FI-60P	
TEMPRA	1969-1995	FI-13	FI-13	
		FI-13P	FI-13P	
		FI-14P	FI-14P	
X 1/9	1972-	AF-71	BMS-3	
		AF-70P	BMS-3P	
			BMS-5	
			BMS-5P	
FIAT (ARGENTINA)	128	-	NE-4	NE-66
			NE-4P	
	132	-	NE-3	
	600	-	NE-3P	
			NE-3P2	
	147	-	NE-4	
			NE-4P	
	DUNA	1987-1991	FI-1	FI-1
			FI-1P	FI-1P
	DUNA	1992-	FI-1	FI-1
UNO	1983-	FI-11	FI-11	
		FI-11KP	FI-11KP	

MARCA BRAND	MODELO MODEL			
FIAT (ARGENTINA)			FI-11P	FI-11P
			FI-1P	FI-1P
	REGATA	1983-	FI-1	FI-1
			FI-18	FI-11
			FI-18P	FI-11KP
			FI-11	FI-11P
			FI-11KP	FI-1P
			FI-11P	
			FI-1P	
	SPAZIO	-	AF-71	BMS-3
			AF-70P	BMS-3P
			FI-61	BMS-5
			FI-60P	BMS-5P
			FI-61	
		FI-60P		
		FO-FR		
		FO-FRP		
		SIP-3		
TEMPRA	-	FI-13	FI-13	
		FI-13P	FI-13P	
FIAT (BRASIL)	ELBA	1992-	FI-1	FI-1
	PREMIO	1992-	FI-11	FI-11
	UNO	1983-	FI-11KP	FI-11KP
			FI-11P	FI-11P
		FI-1P	FI-1P	
PALIO	1996-1997	FI-13P2	FI-13P2	
FIAT (TUNISIA)	131	1973-1988	AF-71	BMS-3
			AF-70P	BMS-3P
			AF-61	BMS-5
			AF-60P	BMS-5P
			AF-61	
			AF-50P	
	131	1981-	FI-30	FI-30
			FI-30P2	FI-30P2
			FI-30	FI-61
			FI-30P2	FI-60P
			FI-61	
			FI-60P	
	SERCE	-	AF-71	BMS-3
			AF-70P	BMS-3P
		AF-60	BMS-5	
		AF-50P	BMS-5P	
		FEM-10		
		FEM-11		
		FEM-20		
		FEM-21		
		FO-FR		
		FO-FRP		
		SIP-2		
TEMPRA	1969-	FI-13	FI-13	
		FI-13P	FI-13P	
		FI-14P	FI-14P	
FIAT (MORO)	131 D MAIL	1974-	AF-71	BMS-3
			AF-70P	BMS-3P
				BMS-5
				BMS-5P
228	-	AF-71	AF-50	
		AF-70P	AF-51	
		AF-60	AF-60	

AUTOMÓVIL - CAMIONETA

CAR - PICK-UP TRUCKS

MARCA BRAND	MODELO MODEL			
FIAT IVECO			AF-9DP	AF-6I
			AF-9I	
			AF-9IP	
000 E	1989-	FI-9I	AF-10	
		FI-9IP	AF-9I	
			AF-6D	
			AF-6I	
000 T	1976-	AF-7I	AF-10	
		AF-7IP	AF-9I	
		AF-6D	AF-6D	
		AF-6DP	AF-6I	
		AF-6I		
		AF-6IP		
		AF-9D		
		AF-9DP		
		AF-9I		
		AF-9IP		
DAILY 30	-1994	AF-7I	BMS-3	
DAILY 35	-1994	AF-7IP	BMS-3P	
DAILY 40	-1994	FI-9I	BMS-5	
DAILY 50	-1994	FI-9IP	BMS-5P	
DAILY 30	1995-1999	FI-2D	FI-2D	
DAILY 35	1995-1999	FI-2DP3	FI-2DP3	
DAILY 40	1995-1999	FI-2D	FI-3D	
DAILY 50	1995-1999	FI-2DP1	FI-3DP1	
		FI-6I	FI-6I	
		FI-6IP1	FI-6IP1	
DAILY 30	1999-1999	FI-11	FI-11	
DAILY 35	1999-1999	FI-11KP	FI-11KP	
DAILY 40	1999-1999	FI-11P	FI-11P	
DAILY 45	1999-1999			
DAILY 49	1999-1999			
DAILY 50	1999-1999			
FIORINO	1988-1990			
MARENGO R.	1995-1996			
PANDA	-1994			
PENNY	-1991			
UMO	-1991			
DUCATO 18	-1998	FI-12	FI-12	
DUCATO 13	-1998	FI-12P1	FI-12P1	
DUCATO MAXI	-1998	FI-12P3	FI-12P3	
		FI-3D	FI-3D	
		FI-3DP3	FI-3DP3	
		FI-6I	FI-6I	
		FI-6IP3	FI-6IP3	
DUCATO 18	1999-1996	FI-3D	FI-3D	
DUCATO 14	1999-1996	FI-3DP3	FI-3DP3	
DUCATO 4x4	1999-1996	FI-6I	FI-6I	
DUCATO MAX	1999-1996	FI-6IP3	FI-6IP3	
FIORINO	-1992	AF-9D	BMS-3	
		AF-9DP	BMS-3P	
		AF-9I	BMS-5	
		AF-9IP	BMS-5P	
		FI-9I		
		FI-9IP		
FIORINO	1993-1997	AF-7I	BMS-3	
		AF-7IP	BMS-3P	
		FI-9IP1	BMS-5	
		FI-9I	BMS-5P	

MARCA BRAND	MODELO MODEL			
FIAT IVECO			FI-6IP	
	TALENTO	-	FI-6I	FI-6I
			FI-6IP	FI-6IP
FORD	CAPRI	-	FO-E/TC	FO-E/TC
			FO-E/TCP	FO-E/TCP
			FO-TC	FO-TC
			FO-TX	FO-TX
			FO-TXKP	FO-TXKP
			FO-TXP	FO-TXP
				FO-XB
CARGO	-	LF-WB	LF-WB	
		NE-11		
		NE-11P		
		NE-24		
		NE-24P		
CARGO	1987-1999	NE-11	LF-WB	
		NE-11P		
CARGO	1999-	NE-11	NE-11	
		NE-11P	NE-11P	
CONSUL	-	FO-E/TC	FO-E/TC	
CORTINA	-	FO-E/TCP	FO-E/TCP	
		FO-TC	FO-TC	
			FO-XB	
ESCORT	-1996	FO-E/TC	FO-E/TC	
FIESTA	-1998	FO-E/TCP	FO-E/TCP	
		FO-TC	FO-TC	
		FO-TX	FO-TX	
		FO-TX1	FO-TX1	
		FO-TX1P	FO-TX1P	
		FO-TX2	FO-TX2	
		FO-TX2P	FO-TX2P	
		FO-TXKP	FO-TXKP	
		FO-TXP	FO-TXP	
ESCORT	1996-1998	FO-4P	FO-4P	
GRANADA	1996-			
ORION	1996-1999			
SCORPIO	1996-1999			
SIERRA	1996-1999			
ESCORT	1999-1995	FO-6P	FO-6P	
FIESTA	1999-1995			
MONDEO	1993-1995			
ORION	1999-			
SCORPIO	1999-1999			
SCORPIO	1999-1995			
SIERRA	1999-1999			
SIERRA	1999-			
ESCORT VAN	-	FO-E/TC	FO-E/TC	
		FO-E/TCP	FO-E/TCP	
		FO-TX	FO-TX	
		FO-TXKP	FO-TXKP	
		FO-TXP	FO-TXP	
GRANADA	-1996	FO-E/TC	FO-E/TC	
ORION	-1996	FO-E/TCP	FO-E/TCP	
SIERRA	-1996	FO-TX	FO-TX	
		FO-TX1	FO-TX1	
		FO-TX1P	FO-TX1P	
		FO-TX2	FO-TX2	
		FO-TX2P	FO-TX2P	
		FO-TXKP	FO-TXKP	

MARCA BRAND	MODELO MODEL			
FORD			FO-TXP	FO-TXP
	MAVERICK	1993-1995	FO-18P	FO-18P
	PROBE	1993-1996	FO-9D	FO-9D
			FO-9DP	FO-9DP
	TAURUS	-	FO-E/TC	FO-E/TC
			FO-E/TCP	FO-E/TCP
	TRANSIT 1990	-	FO-7C	FO-PRL
	TRANSIT E	-1996	FO-E/TC	UN-FT
			FO-E/TCP	UN-TF
			FO-TX	
			FO-TX1	
			FO-TX1P	
			FO-TX2	
			FO-TX2P	
			FO-TXXP	
			FO-TXP	
	TRANSIT E	1996-	FO-22P	FO-22P
		FO-4P	FO-4P	
FORD (ARGENTINA)	ESCORT	-1996	FO-E/TC	FO-E/TC
			FO-E/TCP	FO-E/TCP
			FO-TC	FO-TC
			FO-TX	FO-TX
			FO-TX1	FO-TX1
			FO-TX1P	FO-TX1P
			FO-TX2	FO-TX2
			FO-TX2P	FO-TX2P
			FO-TXXP	FO-TXXP
			FO-TXP	FO-TXP
	ESCORT	1996-1998	FO-4P	FO-4P
	SIERRA	1996-1998		
	ESCORT	1998-1995	FO-6P	FO-6P
	FIESTA	1995-1996		
	MONDEO	1995-1996		
	SIERRA	1998-1999		
	SIERRA	1996-		
	ESCORT VAN	-	FO-E/TC	FO-E/TC
			FO-E/TCP	FO-E/TCP
			FO-TX	FO-TX
			FO-TXXP	FO-TXXP
			FO-TXP	FO-TXP
FALCON	-	FO-2	FO-2	
PICK UP	-1993			
GALAXY	1995-	FO-17P	FO-17P	
GALAXY	-1996	FO-FHP	FO-FHP	
		VO-3CP	VO-3CP	
		VO-HV	VO-HV	
		VO-HVP	VO-HVP	
PICK UP	1993-1994	FO-3D	FO-3D	
		FO-3DP	FO-3DP	
		VO-3CP		
		VO-HV		
		VO-HVP		
PICK-UP	1995-1996	FO-11D	FO-11D	
SIERRA	-1996	FO-E/TC	FO-E/TC	
		FO-E/TCP	FO-E/TCP	
		FO-TX	FO-TX	
		FO-TX1	FO-TX1	
		FO-TX1P	FO-TX1P	
		FO-TX2	FO-TX2	

MARCA BRAND	MODELO MODEL			
FORD (ARGENTINA)			FO-TX2P	FO-TX2P
			FO-TXXP	FO-TXXP
			FO-TXP	FO-TXP
	TAURUS	-	FO-TX	FO-TX
			FO-TXXP	FO-TXXP
		FO-TXP	FO-TXP	
FORD (AUSTRALIA)	CAPRI	-1978	FO-D	FO-TC
			FO-TC	FO-XL
	CAPRI	1978-	FO-2	FO-2
			FO-TX	FO-TX
			FO-TXXP	FO-TXXP
			FO-TXP	FO-TXP
	EXPLORER	1996-1997	FO-15D	FO-15D
	TAURUS	1996-1997	FO-15DP	FO-15DP
	TAURUS WAGON	1996-1997		
	FESTIVA	1993-1994	KI-10	KI-10
			KI-10P	KI-10P
	FESTIVA	1994-	FO-12	FO-12
		FO-12P	FO-12P	
LASER	1988-1994	FO-14DP	FO-14DP	
LASER	1996-1993	FO-13DP	FO-13DP	
TELSTAR	-	MAZ-2D	MAZ-2D	
		MAZ-2DP	MAZ-2DP	
FORD (BRASIL)	CORCEL	-	FO-3D	FO-3D
	DEL REY	-	FO-3DP	FO-3DP
	ESCORT	-1996	FO-E/TC	FO-E/TC
			FO-E/TCP	FO-E/TCP
			FO-TC	FO-TC
			FO-TX	FO-TX
			FO-TX1	FO-TX1
			FO-TX1P	FO-TX1P
			FO-TX2	FO-TX2
			FO-TX2P	FO-TX2P
			FO-TXXP	FO-TXXP
			FO-TXP	FO-TXP
	ESCORT	1996-1998	FO-4P	FO-4P
	ESCORT	1998-1995	FO-6P	FO-6P
	ESCORT VAN	-	FO-E/TC	FO-E/TC
	SIERRA	-	FO-E/TCP	FO-E/TCP
	VERONA	-	FO-TX	FO-TX
		FO-TXXP	FO-TXXP	
		FO-TXP	FO-TXP	
PICK-UP	1995-1996	FO-3P	FO-3P	
VANOS - SEVERAL	1996-	FO-17P	FO-17P	
FORD (SOUTH AFRICA)	SAPPHIRE	1996-	FO-6P	FO-6P
	SIERRA	1996-1998		
	SIERRA	1996-		
	SIERRA	-1996	FO-E/TC	FO-E/TC
			FO-E/TCP	FO-E/TCP
			FO-TX	FO-TX
		FO-TX1	FO-TX1	
		FO-TX1P	FO-TX1P	
		FO-TX2	FO-TX2	
		FO-TX2P	FO-TX2P	
		FO-TXXP	FO-TXXP	
		FO-TXP	FO-TXP	
SIERRA	1996-1998	FO-4P	FO-4P	
FORD (USA)	AEROSTAR	1996-1991	FO-28D	FO-28D
			FO-8D	FO-8D

AUTOMÓVIL - CAMIONETA

CAR - PICK-UP TRUCKS

MARCA BRAND	MODELO MODEL			
FORD (USA)	AEROSTAR	1991-1996	FO-11D	FO-1
	EXPLORER	1991-1996		
	TAURUS S.	1991-1996		
	T-BIRD S.	1991-		
	AEROSTAR	1996-1997	FO-15D	FO-15D
	BRONCO PICK	1996-1997	FO-15DP	FO-15DP
	EXPLORER	1996-1997		
	TAURUS	1996-1997		
	TAURUS WAGON	1996-1997		
	ASPIRE	1994-	FO-12 FO-12P	FO-12 FO-12P
	BRONCO	1967-1989	FO-2	FO-1
	CROWN	1967-1989		
	ESCORT	1981-1996		
	MUSTANG	1967-1998		
	T-BIRD	1967-1984		
	TEMPO GL	1983-1986		
	TEMPO GLS	1983-1986		
	VICTORIA	1967-1990		
	CONCOURSE E	1995-	FO-1	FO-1
	CONTOUR	1995-1997	FO-8D	FO-8D
	CROWN	1998-1998	FO-11D	FO-11D
	SABLE	1998-	FO-29D	FO-29D
	TAURUS	1998-1998		
	T-BIRD	1986-1991		
	TEMPO GL	1986-1991		
	TEMPO GLS	1986-1991		
	VICTORIA	1998-1998		
	ESCORT	1998-1998	FO-8D	FO-8D
	SABLE	1987-1999	FO-8DP	FO-8DP
	TAURUS	1986-1989		
	FESTIVA	1987-1989	MAZ-6D	MAZ-6D
	PROBE	1987-1989	MAZ-6DP	MAZ-6DP
	FESTIVA	1998-	FO-18DP FO-7P	
	FIESTA	-1979	FO-TC LF-5L	FO-TC LF-5L
	FIESTA	1979-1984	FO-TX	FO-TX
MERKUR	1985-1989	FO-TXXP	FO-TXXP	
XM TI	1985-1989	FO-TXP	FO-TXP	
MERKUR	1998-1992	FO-14DP	FO-14DP	
PROBE	1998-1992	FO-7P	FO-7P	
PROBE	1993-1996	FO-8D FO-8DP	FO-8D FO-8DP	
SCORPIO	1987-	FO-32P FO-4P	FO-32P FO-4P	
SCORPIO	1988-	FO-6P	FO-6P	
FORD (USA) (LINCOLN)	CONTINENTAL	1967-1984	FO-2	FO-1
	CONTINENTAL	1985-1991	FO-29D	FO-29D
	CONTINENTAL	1991-1998	FO-11D	FO-11D
	MARK SERIES	1985-1991	FO-11D FO-29D	FO-11D FO-29D
FORD (USA) (MERCURY)	CAPRI	1978-1979	FO-8	FO-XL
	CAPRI	1978-1983		
	CAPRI	1972-1979	FO-E/TC FO-E/TCP FO-TC	FO-E/TC FO-E/TCP FO-TC
	CAPRI	1983-1991	FO-2	FO-2
	MERCURY	-1992		



MARCA BRAND	MODELO MODEL			
FORD (USA) (MERCURY)	CAPRI	1981-	FO-14DP	FO-14DP
	TRACER	1987-1998	FO-7P	FO-7P
	COUGAR	1967-1984	FO-2	FO-1
	MARQUIS	1967-1989		
	TOPAZ	1980-1985		
	COUGAR	1998-	FO-11D	FO-11D
	MARQUIS	1991-	FO-29D	FO-29D
	TOPAZ	1998-		
	G.MARQUIS	1993-1998	FO-8D	FO-8D
	MERCURY	1993-1996	FO-8DP1	FO-8DP1
	SABLE	1993-1996		
	MYSTIQUE	1995-1997	FO-8D	FO-8D
	SABLE GS/LS	1996-1997	FO-15D FO-15DP	FO-15D FO-15DP
	TRACER	1998-	FO-8D FO-8DP FO-8DP1	FO-8D FO-8DP FO-8DP1
	FREIGHTLINER	MODELOS - MODELS	1978-	YA-8D
GM (BUICK)	J.E PAVENUE	1992-		GM-12
	LESABRE	1991-1996		GM-12P
	RIATA	1992-		GM-H
	RIVIERA	1992-1995		GM-HP
	CENTURY	1991-1997	GM-8	GM-12
	MODELOS - MODELS	1981-	GM-8P GM-E GM-EP	GM-12P GM-H GM-HP
	LESABRE	1996-1997		GM-14
	ROADMASTER	1996-1997		GM-14P GM-25 GM-25P
	MODELOS - MODELS	1935-1966	BAS-11	BAS-11
	MODELOS - MODELS	1966-	GM-6	GM-6
	MODELOS - MODELS	1967-	GM-6P	GM-6P
	MODELOS - MODELS	1971-	GM-A	GM-A
	MODELOS - MODELS	1975-	GM-AP	GM-AP
	MODELOS - MODELS	1986-		
	MODELOS - MODELS	1988-	GM-7	GM-7
	MODELOS - MODELS	1972-	GM-7P GM-C GM-CP	GM-7P GM-C GM-CP
	MODELOS - MODELS	1989-	GM-8	GM-8
	MODELOS - MODELS	1973-	GM-8P GM-E GM-EP	GM-8P GM-E GM-EP
	MODELOS - MODELS	1978-	GM-9	GM-9
	MODELOS - MODELS	1974-	GM-9P	GM-9P
	MODELOS - MODELS	1978-	GM-J GM-JP	GM-J GM-JP
	MODELOS - MODELS	1976-	GM-7 GM-7P GM-C GM-CP	GM-11 GM-11P GM-7 GM-7P GM-C GM-CP
	MODELOS - MODELS	1977-	GM-8 GM-8P GM-E	GM-12 GM-12P GM-8

MARCA BRAND	MODELO MODEL				
GM (BUICK)			GM-EP	GM-8P GM-E GM-EP GM-H GM-HP	
	MODELOS - MODELS 1979-		GM-E GM-EP GM-A GM-AP	GM-18 GM-18P GM-E GM-EP GM-A GM-AP GM-B GM-8P	
	MODELOS - MODELS 1980-		GM-7 GM-7P GM-C GM-CP	GM-11 GM-11P GM-D GM-CP	
	MODELOS - MODELS 1982-		GM-9 GM-9P GM-J GM-JP	GM-13 GM-13P GM-K GM-KP	
	MODELOS - MODELS 1983-		GM-E GM-EP GM-A GM-AP	GM-18 GM-18P GM-B GM-8P	
	MODELOS - MODELS 1984-		GM-E	GM-18	
	MODELOS - MODELS 1985-		GM-EP GM-7 GM-7P GM-A GM-AP GM-C GM-CP	GM-18P GM-7 GM-7P GM-B GM-8P GM-C GM-CP	
	REGAL 1988-1990		GM-19P		
	REGAL 1991-		GM-20P		
	RIVIERA 1995-		GM-14	GM-14	
	SKYLARK 1994-		GM-14P GM-25 GM-25P	GM-14P GM-25 GM-25P	
		RIVIERA 3.0V 1989-1990		GM-11 GM-11P GM-D GM-CP	
	SKYLARK 1992-1993		GM-22 GM-22P GM-23 GM-23P	GM-22 GM-22P GM-23 GM-23P	
		GM (CADILLAC)	ALLANTE 1987-1988	GM-16P	
			BROUGHAM 1990-1997		GM-12
			C.DE VILLE 1991-		GM-12P
	ELDORADO-TC 1991-			GM-H	
	FLEETWOOD 1991-			GM-HP	
	SEVILLE 1991-				
	ELDORADO-TC 1989-1990			GM-11 GM-11P GM-D GM-CP	
	MODELOS - MODELS 1925-1966		BAS-11	BAS-11	
	MODELOS - MODELS 1960-		GM-E	GM-E	



MARCA BRAND	MODELO MODEL			
GM (CADILLAC)	MODELOS - MODELS 1967-		GM-EP	GM-EP
	MODELOS - MODELS 1971-		GM-A	GM-A
	MODELOS - MODELS 1975-		GM-AP	GM-AP
	MODELOS - MODELS 1980-			
	MODELOS - MODELS 1988-		GM-7	GM-7
	MODELOS - MODELS 1977-		GM-7P GM-C GM-CP	GM-7P GM-C GM-CP
		MODELOS - MODELS 1988-	GM-8	GM-8
		MODELOS - MODELS 1973-	GM-8P GM-E GM-EP	GM-8P GM-E GM-EP
	MODELOS - MODELS 1978-	GM-9	GM-9	
	MODELOS - MODELS 1974-	GM-9P	GM-9P	
	MODELOS - MODELS 1979-		GM-J GM-JP	GM-J GM-JP
		MODELOS - MODELS 1976-	GM-7 GM-7P GM-C GM-CP	GM-11 GM-11P GM-7 GM-7P GM-C GM-CP
	MODELOS - MODELS 1977-		GM-8 GM-8P GM-E GM-EP	GM-12 GM-12P GM-8 GM-8P GM-E GM-EP GM-H GM-HP
		MODELOS - MODELS 1975-	GM-E GM-EP GM-A GM-AP	GM-18 GM-18P GM-E GM-EP GM-A GM-AP GM-B GM-8P
		MODELOS - MODELS 1986-	GM-7 GM-7P GM-C GM-CP	GM-11 GM-11P GM-D GM-CP
		MODELOS - MODELS 1981-	GM-8 GM-8P GM-E GM-EP	GM-12 GM-12P GM-H GM-HP
		MODELOS - MODELS 1982-	GM-9 GM-9P GM-J GM-JP	GM-13 GM-13P GM-K GM-KP
	MODELOS - MODELS 1983-		GM-E GM-EP GM-A GM-AP	GM-18 GM-18P GM-B GM-8P
		MODELOS - MODELS 1984-	GM-6	GM-18
		MODELOS - MODELS 1985-	GM-6P GM-7 GM-7	GM-18P GM-7 GM-7
	MODELOS - MODELS 1984-	GM-6	GM-18	
	MODELOS - MODELS 1985-	GM-6P GM-7 GM-7P GM-A GM-AP GM-C GM-CP	GM-18P GM-7 GM-7P GM-B GM-8P GM-C GM-CP	
	MODELOS - MODELS 1984-	GM-6	GM-18	
	MODELOS - MODELS 1985-	GM-6P GM-7 GM-7	GM-18P GM-7 GM-7	



AUTOMÓVIL - CAMIONETA

CAR - PICK-UP TRUCKS

MARCA BRAND	MODELO MODEL			
GM (CADILLAC)			GM-7P	GM-7P
			GM-A	GM-B
			GM-AP	GM-SP
			GM-C	GM-C
			GM-CP	GM-CP
GM (CHEVROLET BRA.)	CHEVARI	-	OP-WHP	OP-WHP
	CHEVROLET	1982-1987	OP-WYP	OP-WYP
	COMMODORE	-		
	MONZA	1982-1987		
	OMEGA	-		
	CHEVETTE	1987-1989	OP-B	OP-B
	CHEVROLET	1987-	OP-8P	OP-8P
			OP-T	OP-T
			OP-TP	OP-TP
	CHEVROLET	1989-1998	OP-D	OP-D
	PANEMA	1989-	OP-DKP	OP-DKP
			OP-DP	OP-DP
			OP-S	OP-S
			OP-SKP	OP-SKP
			OP-SP	OP-SP
	CHEVROLET	1998-	SUZU-7	SUZU-7
	SPRINT 1.8	-	SUZU-7P	SUZU-7P
	DIPLOMATA	-	CHR-B	CHR-B
			CHR-8P	CHR-8P
	MODELOS - MODELS	1926-1936	BAS-11	BAS-11
	MODELOS - MODELS	1936-	GM-E	GM-E
	MODELOS - MODELS	1957-	GM-6P	GM-6P
	MODELOS - MODELS	1971-	GM-A	GM-A
	MODELOS - MODELS	1975-	GM-AP	GM-AP
	MODELOS - MODELS	1986-	GM-7	GM-7
	MODELOS - MODELS	1972-	GM-7P	GM-7P
			GM-C	GM-C
			GM-CP	GM-CP
	MODELOS - MODELS	1969-	GM-8	GM-8
	MODELOS - MODELS	1973-	GM-8P	GM-8P
			GM-E	GM-E
			GM-EP	GM-EP
	MODELOS - MODELS	1978-	GM-9	GM-9
MODELOS - MODELS	1974-	GM-9P	GM-9P	
MODELOS - MODELS	1978-	GM-J	GM-J	
		GM-JP	GM-JP	
MODELOS - MODELS	1976-	GM-7	GM-11	
		GM-7P	GM-11P	
		GM-C	GM-7	
		GM-CP	GM-7P	
			GM-C	
			GM-CP	
MODELOS - MODELS	1977-	GM-8	GM-12	
		GM-8P	GM-12P	
		GM-E	GM-8	
		GM-EP	GM-8P	
			GM-E	
		GM-EP		
		GM-H		
		GM-HP		
MODELOS - MODELS	1979-	GM-E	GM-18	

MARCA BRAND	MODELO MODEL				
GM (CHEVROLET BRA.)			GM-6P	GM-18P	
			GM-A	GM-E	
			GM-AP	GM-6P	
				GM-A	
				GM-AP	
				GM-B	
				GM-8P	
	MODELOS - MODELS	1988-	GM-7	GM-11	
			GM-7P	GM-11P	
			GM-C	GM-D	
			GM-CP	GM-8P	
	MODELOS - MODELS	1989-	GM-8	GM-12	
			GM-8P	GM-12P	
			GM-E	GM-H	
			GM-EP	GM-HP	
	MODELOS - MODELS	1982-	GM-9	GM-13	
			GM-9P	GM-13P	
			GM-J	GM-K	
			GM-JP	GM-KP	
	MODELOS - MODELS	1983-	GM-G	GM-18	
			GM-6P	GM-18P	
			GM-A	GM-8	
			GM-AP	GM-8P	
	MODELOS - MODELS	1984-	GM-G	GM-18	
	MODELOS - MODELS	1985-	GM-6P	GM-18P	
			GM-7	GM-7	
			GM-7P	GM-7P	
			GM-A	GM-8	
			GM-AP	GM-8P	
			GM-C	GM-C	
			GM-CP	GM-CP	
	GM (CHEVROLET)	ASTRO VAN	1998-1997	GM-14	GM-14
		CAVALIER	1998-1997	GM-14P	GM-14P
LARGE BLAZER		1998-1997	GM-25	GM-25	
LARGE PICKUP		1998-1997	GM-25P	GM-25P	
MODELOS - MODELS		1995-			
S-18 BLAZER		1998-1997			
S-18 PICKUP		1998-1997			
VENTURE		1997-			
BERETTA		1987-1988	GM-17P	GM-11	
CORSICA		1987-1988		GM-11P	
				GM-D	
				GM-8P	
BERETTA		1991-	GM-18P	GM-12	
CORSICA		1991-		GM-12P	
				GM-H	
				GM-HP	
CAMARO		1989-1988		GM-11	
CORVETTE		1989-1988		GM-11P	
				GM-D	
				GM-8P	
CAMARO		1991-		GM-12	
CAVALIER RS	1991-		GM-12P		
CORVETTE	1991-		GM-H		
			GM-HP		
CAVALIER LS	1991-1992	GM-22			
		GM-22P			
CAVALIER LS	1993-	GM-23			
		GM-23P			

MARCA BRAND	MODELO MODEL				
GM (CHEVROLET)	KODIAK G	1997-	GM-B	GM-12	
	MODELOS - MODELS	1991-	GM-8P	GM-12P	
	WHEELER	1997-	GM-E	GM-H	
	LUMINA	1988-1998	GM-EP	GM-HP	
			GM-19P	GM-11	
				GM-11P	
				GM-D	
				GM-9P	
	LUMINA	1991-	GM-29P	GM-13	
				GM-12P	
				GM-H	
				GM-HP	
	MODELOS - MODELS	1925-1966	BAS-11	BAS-11	
	MODELOS - MODELS	1960-	GM-E	GM-E	
	MODELOS - MODELS	1967-	GM-6P	GM-6P	
	MODELOS - MODELS	1971-	GM-A	GM-A	
	MODELOS - MODELS	1975-	GM-AP	GM-AP	
	MODELOS - MODELS	1980-			
	MODELOS - MODELS	1968-	GM-7	GM-7	
	MODELOS - MODELS	1972-	GM-7P	GM-7P	
			GM-C	GM-C	
			GM-CP	GM-CP	
	MODELOS - MODELS	1969-	GM-B	GM-B	
	MODELOS - MODELS	1973-	GM-8P	GM-8P	
			GM-E	GM-E	
			GM-EP	GM-EP	
	MODELOS - MODELS	1976-	GM-B	GM-B	
	MODELOS - MODELS	1974-	GM-9P	GM-9P	
	MODELOS - MODELS	1978-	GM-J	GM-J	
			GM-JP	GM-JP	
	MODELOS - MODELS	1976-	GM-7	GM-11	
			GM-7P	GM-11P	
			GM-C	GM-7	
GM-CP			GM-7P		
			GM-C		
			GM-CP		
MODELOS - MODELS	1977-	GM-B	GM-12		
		GM-8P	GM-12P		
		GM-E	GM-B		
		GM-EP	GM-8P		
			GM-E		
			GM-EP		
			GM-H		
	GM-HP				
MODELOS - MODELS	1979-	GM-E	GM-18		
		GM-6P	GM-18P		
		GM-A	GM-6		
		GM-AP	GM-6P		
			GM-A		
		GM-AP			
		GM-B			
		GM-8P			
MODELOS - MODELS	1980-	GM-7	GM-11		
		GM-7P	GM-11P		
		GM-C	GM-D		
		GM-CP	GM-9P		
MODELOS - MODELS	1982-	GM-B	GM-13		

MARCA BRAND	MODELO MODEL			
GM (CHEVROLET)			GM-9P	GM-13P
			GM-J	GM-K
			GM-JP	GM-KP
	MODELOS - MODELS	1980-	GM-E	GM-18
			GM-6P	GM-18P
			GM-A	GM-B
			GM-AP	GM-8P
	MODELOS - MODELS	1984-	GM-E	GM-18
	MODELOS - MODELS	1985-	GM-6P	GM-18P
			GM-7	GM-7
			GM-7P	GM-7P
			GM-A	GM-B
			GM-AP	GM-8P
			GM-C	GM-C
			GM-CP	GM-CP
	SPARK	-	DAE-3P2	DAE-3P2
	SPECTRUM	1985-1989	GM-2	GM-2
			GM-2P	GM-2P
	SPRINT	1985-1988	GM-1P	GM-1P
			MIT-21	MIT-21
GM (GOL)	METRO	1980-	GM-5	GM-5
	STROM	1988-	GM-5P	GM-5P
	PRIZM	1990-1994	GM-24	GM-24
			GM-24P	GM-24P
SPECTRUM	1985-	GM-2	GM-2	
STROM	1989-1990	GM-2P	GM-2P	
GM (GMC)	MODELOS - MODELS	1925-1966	BAS-11	BAS-11
	MODELOS - MODELS	1960-	GM-E	GM-E
	MODELOS - MODELS	1967-	GM-6P	GM-6P
	MODELOS - MODELS	1971-	GM-A	GM-A
	MODELOS - MODELS	1975-	GM-AP	GM-AP
	MODELOS - MODELS	1980-		
	MODELOS - MODELS	1968-	GM-7	GM-7
	MODELOS - MODELS	1972-	GM-7P	GM-7P
			GM-C	GM-C
			GM-CP	GM-CP
	MODELOS - MODELS	1969-	GM-B	GM-B
	MODELOS - MODELS	1973-	GM-8P	GM-8P
			GM-E	GM-E
			GM-EP	GM-EP
	MODELOS - MODELS	1976-	GM-B	GM-B
	MODELOS - MODELS	1974-	GM-9P	GM-9P
	MODELOS - MODELS	1978-	GM-J	GM-J
			GM-JP	GM-JP
	MODELOS - MODELS	1976-	GM-7	GM-11
			GM-7P	GM-11P
GM-C			GM-7	
GM-CP			GM-7P	
			GM-C	
			GM-CP	
MODELOS - MODELS	1977-	GM-B	GM-12	
		GM-8P	GM-12P	
		GM-E	GM-B	
		GM-EP	GM-8P	
			GM-E	
			GM-EP	
			GM-H	
	GM-HP			
MODELOS - MODELS	1979-	GM-E	GM-18	
		GM-6P	GM-18P	
		GM-A	GM-6	
		GM-AP	GM-6P	
			GM-A	
		GM-AP		
		GM-B		
		GM-8P		
MODELOS - MODELS	1980-	GM-7	GM-11	
		GM-7P	GM-11P	
		GM-C	GM-D	
		GM-CP	GM-9P	
MODELOS - MODELS	1982-	GM-B	GM-13	

AUTOMÓVIL - CAMIONETA

CAR - PICK-UP TRUCKS

MARCA BRAND	MODELO MODEL				
GM (GMC)	MODELOS - MODELS 1979-			GM-HP	
				GM-B	
				GM-19	
				GM-EP	
				GM-19P	
				GM-A	
				GM-6	
				GM-AP	
				GM-6P	
				GM-A	
	GM-AP				
	GM-B				
	GM-8P				
	MODELOS - MODELS 1988-	GM-7	GM-11		
	SIERRA GLE 1991-	GM-7P	GM-11P		
		GM-C	GM-D		
		GM-CP	GM-DP		
	MODELOS - MODELS 1991-	GM-8	GM-12		
		GM-8P	GM-12P		
		GM-E	GM-H		
		GM-EP	GM-HP		
	MODELOS - MODELS 1992-	GM-9	GM-13		
		GM-9P	GM-13P		
		GM-J	GM-K		
		GM-JP	GM-KP		
	MODELOS - MODELS 1993-	GM-6	GM-10		
		GM-6P	GM-10P		
GM-A		GM-8			
GM-AP		GM-8P			
MODELOS - MODELS 1994-	GM-6	GM-10			
MODELOS - MODELS 1995-	GM-6P	GM-10P			
	GM-7	GM-7			
	GM-7P	GM-7P			
	GM-A	GM-8			
	GM-AP	GM-8P			
	GM-C	GM-C			
	GM-CP	GM-CP			
	GM-12				
GM-12P					
GM-H					
GM-HP					
GM (OLDS MOBILE)	98 REGENCY 1991-			GM-12	
				DELTA 88 HO. 1992-	GM-12P
				TORONADO 1991-	GM-H
	ACHEVA 1992-1993				GM-22
					GM-22P
					GM-23
					GM-23P
	ACHEVA 1994-	GM-14	GM-14		
	AURORA 1995-				GM-14P
					GM-25
					GM-25P
	ALERO 2000-2004	GM-14	GM-14		
	INTRIGUE 2000-2003	GM-14P	GM-14P		
	CUTLASS 1989-1990	GM-19P			
	SILHOUETTE 1989-1990				
	CUTLASS SUP. 1991-	GM-29P			
	MODELOS - MODELS 1935-1966	BAS-11	BAS-11		
	MODELOS - MODELS 1966-	GM-6	GM-6		
	MODELOS - MODELS 1967-	GM-6P	GM-6P		
	MODELOS - MODELS 1971-	GM-A	GM-A		
	MODELOS - MODELS 1975-	GM-AP	GM-AP		
	MODELOS - MODELS 1980-				
	MODELOS - MODELS 1988-	GM-7	GM-7		
	MODELOS - MODELS 1972-	GM-7P	GM-7P		
		GM-C	GM-C		



MARCA BRAND	MODELO MODEL				
GM (OLDS MOBILE)	MODELOS - MODELS 1988-			GM-CP	
				GM-CP	
				GM-8	
	MODELOS - MODELS 1921-				GM-8
					GM-8P
					GM-8P
	MODELOS - MODELS 1929-				GM-E
					GM-E
					GM-E
	MODELOS - MODELS 1939-				GM-EP
					GM-EP
					GM-EP
	MODELOS - MODELS 1939-				GM-9
					GM-9
					GM-9
	MODELOS - MODELS 1939-				GM-9P
					GM-9P
					GM-9P
	MODELOS - MODELS 1939-				GM-J
					GM-J
					GM-J
	MODELOS - MODELS 1939-				GM-JP
					GM-JP
					GM-JP
	MODELOS - MODELS 1939-				GM-7
					GM-7
					GM-11
GM-7P					
GM-11P					
GM-C					
GM-7					
GM-7P					
GM-C					
GM-CP					
GM-7P					
GM-11					
GM-11P					
GM-D					
GM-7					
GM-7P					
GM-C					
GM-CP					
GM-CP					
GM-D					
GM-8P					
GM-12					
GM-12P					
GM-8					
GM-8P					
GM-E					
GM-8					
GM-EP					
GM-8P					
GM-E					
GM-EP					
GM-E					
GM-EP					
GM-H					
GM-HP					
MODELOS - MODELS 1929-	GM-6	GM-10			
	GM-6P	GM-10P			
	GM-A	GM-8			
	GM-AP	GM-8P			
	GM-A	GM-A			
	GM-AP	GM-AP			
	GM-B	GM-B			
	GM-8P	GM-8P			
MODELOS - MODELS 1988-	GM-7	GM-11			
	GM-7P	GM-11P			
	GM-C	GM-D			
	GM-CP	GM-DP			
MODELOS - MODELS 1988-	GM-8	GM-12			
	GM-8P	GM-12P			
	GM-E	GM-H			
	GM-EP	GM-HP			
MODELOS - MODELS 1982-	GM-9	GM-13			
	GM-9P	GM-13P			
	GM-J	GM-K			
	GM-JP	GM-KP			
MODELOS - MODELS 1980-	GM-6	GM-10			
	GM-6P	GM-10P			
	GM-A	GM-8			
	GM-AP	GM-8P			
MODELOS - MODELS 1984-	GM-6	GM-10			
MODELOS - MODELS 1985-	GM-6P	GM-10P			
	GM-7	GM-7			
	GM-7P	GM-7P			
	GM-A	GM-8			
	GM-AP	GM-8P			
	GM-C	GM-C			
	GM-CP	GM-CP			
TORONADO 1989-1990		GM-11			
		GM-11P			

MARCA BRAND	MODELO MODEL			
GM (OLDS MOBILE)				GM-D GM-DF
GM (PONTIAC)	SONNEVILLE	1992-		GM-12
	FIREBIRD	1991-		GM-12P
	FORMULA	1991-		GM-H
	GTA	1991-		GM-HP
	TRANS AM	1991-		
	GRAND AM	1992-1993	GM-22	
	SUNBIRD	1992-1993	GM-22P GM-23 GM-23P	
	GRAND AM	1994-	GM-14 GM-14P GM-25 GM-25P	GM-14 GM-14P GM-25 GM-25P
	GRAND AM	2000-2005	GM-14 GM-14P	GM-14 GM-14P
	GRAND PRIX	1991-1994	GM-20P	
	LE MANS	1987-	OP-S OP-SKP OP-SP	OP-S OP-SKP OP-SP
	MODELOS - MODELS	1925-1966	BAS-11	BAS-11
	MODELOS - MODELS	1966-	GM-6	GM-6
	MODELOS - MODELS	1967-	GM-6P	GM-6P
	MODELOS - MODELS	1971-	GM-A	GM-A
	MODELOS - MODELS	1975-	GM-AP	GM-AP
	MODELOS - MODELS	1986-		
	MODELOS - MODELS	1968-	GM-7	GM-7
	MODELOS - MODELS	1972-	GM-7P GM-C GM-CP	GM-7P GM-C GM-CP
	MODELOS - MODELS	1969-	GM-8	GM-8
	MODELOS - MODELS	1973-	GM-8P GM-E GM-EP	GM-8P GM-E GM-EP
	MODELOS - MODELS	1976-	GM-9	GM-9
	MODELOS - MODELS	1974-	GM-9P	GM-9P
	MODELOS - MODELS	1978-	GM-J GM-JP	GM-J GM-JP
	MODELOS - MODELS	1976-	GM-7 GM-7P GM-C GM-CP	GM-7 GM-7P GM-C GM-CP
	MODELOS - MODELS	1977-	GM-8 GM-8P GM-E GM-EP	GM-8 GM-8P GM-E GM-EP
	MODELOS - MODELS	1979-	GM-8 GM-8P GM-A GM-AP	GM-8 GM-8P GM-A GM-AP



MARCA BRAND	MODELO MODEL				
GM (PONTIAC)				GM-A GM-AP GM-B GM-8P	
	MODELOS - MODELS	1986-	GM-7 GM-7P GM-C GM-CP	GM-11 GM-11P GM-8 GM-8P	
	MODELOS - MODELS	1985-	GM-8 GM-8P GM-E GM-EP	GM-12 GM-12P GM-H GM-HP	
	MODELOS - MODELS	1982-	GM-9 GM-9P GM-J GM-JP	GM-13 GM-13P GM-K GM-KP	
	MODELOS - MODELS	1983-	GM-8 GM-8P GM-A GM-AP	GM-18 GM-18P GM-B GM-8P	
	MODELOS - MODELS	1984-	GM-6	GM-18	
	MODELOS - MODELS	1986-	GM-6P GM-7 GM-7P GM-A GM-AP GM-C GM-CP	GM-18P GM-7 GM-7P GM-8 GM-8P GM-C GM-CP	
	SUNFIRE	2000-2005	GM-25 GM-25P	GM-25 GM-25P	
	TRANS SPORT	1988-1998	GM-19P		
	GM (SATURN)	SATURN	1998-1994	GM-21 GM-21P	GM-21 GM-21P
		HAMMAG HENSCHEL	F 20 F 25	- -	ME-VA ME-VA
	HOLDEN	APOLLO	1991-	TOYO-14	TOYO-14
		NOVA	1991-	TOYO-14P	TOYO-14P
		ASTRA	1986-	DAT-12	DAT-12
		BARINA	1981-1988	MIT-11	MIT-11
		CAMBIA	1986-	MIT-11P	MIT-11P
		DRIVER	1981-	TOYO-14	TOYO-14
		GEMINI	1988-1984	TOYO-14P	TOYO-14P
		JACKAROO	1988-		
		RODEO	1988-		
		SHUTTLE	1988-		
		BARINA	1991-1993	SUZU-18 SUZU-18P	SUZU-18 SUZU-18P
		BARINA	1994-	OP-S OP-SKP OP-SP	OP-S OP-SKP OP-SP
		BELMOND	1971-1978	GM-6	GM-6
		KINGSWOOD	1971-1978	GM-6P	GM-6P
		STATESMAN	1972-1978	GM-A	GM-A
		TOHANA	1971-1972	GM-AP	GM-AP
	BELMOND	-1979	GM-42	GM-42	
	CALAIS	1979-			
	COMMODORE	1979-			
	KINGSWOOD	1979-			
	STATESMAN	1979-			

AUTOMÓVIL - CAMIONETA

CAR - PICK-UP TRUCKS

MARCA BRAND	MODELO MODEL			
HOLDEN	CALAIS	1993-	OP-WHP	OP-WHP
	COMMODORE	1993-		
	COMMODORE	1987-1993	OP-WHP	OP-WHP
			OP-WYP	OP-WYP
	FJ	-	HUD-1	HUD-1
	GEMINI	1985-	GM-2	GM-2
	SPECTRUM	1985-	GM-2P	GM-2P
	GEMINI STAT.	1981-	MIT-11	OP-AB
			MIT-11P	OP-ABP
			TOYO-14	OP-BA
		TOYO-14P	OP-BAP	
			OP-J	
			OP-JP	
MODELOS-MODELS	1955-1979	BAS-11	BAS-11	
TORANA	-1971	BAS-11	UN-FS	
HONDA	ACCORD	1976-1988	HOND-1	HOND-1
	CIVIC	1973-1976	HOND-1P	HOND-1P
			HOND-2	HOND-2
			HOND-2P	HOND-2P
	ACCORD	1981-1982	HOND-18	HOND-18
	ACCORD	1984-1990	HOND-18P	HOND-18P
	CITY JAZZ	1981-1985		
	CIVIC	1984-1987		
	PRELUDE	1983-1988		
	PRELUDE	1989-1991		
	QUINTET	1981-1983		
	ACCORD	1982-1983	HOND-18	HOND-18
	CIVIC	1977-1981	HOND-18P	HOND-18P
			HOND-11	HOND-11
			HOND-11P	HOND-11P
	ACCORD	1988-1992	HOND-14	HOND-14
			HOND-14P	HOND-14P
			HOND-15	HOND-15
			HOND-15P	HOND-15P
			HOND-16D	HOND-16D
			HOND-16DP	HOND-16DP
	ACCORD 2 LS	1993-1995	NE-35	NE-35
	ACCORD 2 S	1993-1995	NE-35P2	NE-35P2
	CIVIC	1995-		
	CONCERTO	1985-		
	ACCORD COUPE	1993-1995	HOND-14	HOND-14
	CIVIC	1988-1995	HOND-14P	HOND-14P
	ACCORD EX	1991-1995	HOND-16D	HOND-16D
			HOND-16DP	HOND-16DP
	CIVIC	1972-1973	NE-1	HOND-3D
		NE-1P		
CIVIC	1982-1983	HOND-12	HOND-12	
PRELUDE	1982-	HOND-12P	HOND-12P	
		HOND-13	HOND-13	
		HOND-13P	HOND-13P	
CIVIC CRX	1989-1992	HOND-14	HOND-14	
CIVIC SHUTLE	1989-1992	HOND-14P	HOND-14P	
		HOND-15	HOND-15	
		HOND-15P	HOND-15P	
COUPE	1969-1975	NE-1		
LIFE	1969-1975	NE-1P		
N 364	1969-1975			
TOURER	1969-1975			
PRELUDE	1992-1997	HOND-14	HOND-14	



MARCA BRAND	MODELO MODEL			
HONDA			HOND-14P	HOND-14P
			HOND-16D	HOND-16D
			HOND-16DP	HOND-16DP
HYUNDAI	ACCENT	1994-1996	HY-5	HY-5
	EXCEL	1994-1995	HY-5P	HY-5P
	ELANTRA	1991-1996	HY-4	HY-4
	LANTRA	1991-1996	HY-4P	HY-4P
	TIBURON	2001-	HY-4P2	HY-4P2
			HY-4P3	HY-4P3
	EXCEL	1986-1989	HY-3D	HY-3D
			HY-3DP	HY-3DP
	EXCEL	1998-1991	HY-3D	HY-3D
	PONY	1991-	HY-3DP1	HY-3DP1
	S COUPE	1991-1996		
	SONATA	1991-1996		
	PONY	1994-1979	HY-1	HY-1
	PONY	1988-1984	TOYO-14	TOYO-14
			TOYO-14P	TOYO-14P
	PONY (CAN)	1985-1987	MIT-21	MIT-21
			MIT-21P	MIT-21P
	PONY (EU)	1985-1987	HY-2	HY-2
	STELLAR	1985-1987	HY-2P	HY-2P
			HY-2P	HY-2P
	SONATA	1984-1988	HY-3	HY-3
			HY-3P2	HY-3P2
	SONATA (USA)	1990-1995	HY-6D	HY-6D
	SONICA	1993-1995	HY-6DP	HY-6DP
	STARLEX	1998-	HY-9P2	HY-9P2
	VAN TRANSP.	1994-1997	HY-8	HY-8
		HY-8P	HY-8P	
INFINITI (NISSAN)	G 39	1993-	DAT-18	DAT-18
	M 38	1993-	DAT-18P	DAT-18P
			DAT-7	DAT-7
			DAT-7P	DAT-7P
			DAT-7P1	DAT-7P1
	M 38	1998-1991	DAT-13	DAT-13
			DAT-13P	DAT-13P
			DAT-14	DAT-14
			DAT-14P	DAT-14P
	INNOCENTI	3 CILINDROS	1982-	
MINI 504		1985-		AF-11
MINI DIESEL		1984-		AF-12
MINI MILLE		1988-		
MINI TRE		1984-		
MINI TURBO		1983-		
100		1986-	FI-61	FI-61
654		1986-	FI-61P	FI-61P
998		1986-		
SMALL 500		1986-		
SMALL 998		1986-		
A48		-	UN-1P	UN-1P
ELBA		1992-	FI-11	FI-11
		FI-11KP	FI-11KP	
		FI-11P	FI-11P	
J4	-	UF-0L	UN-FS	
J5	-	UN-FS		
JM 3	-			
MINI 504	-			
MINI 1000	1973-			



MARCA BRAND	MODELO MODEL				
INNOCENTI	MINI 1801	1973-			
	MINI COOPER	1973-			
	KORAL 4L	1990-1992	FI-4L	FI-3D	
	KORAL 55	1990-1992	FI-50P	FI-3DP FI-3DPS	
	M.COOPER DL	-	STR-2	STR-2	
	M.MK 0.854	-	UN-FS	UN-FS	
	M.DE TOMASO	1976-	AF-7I	AF-10	
	MINI 98	1974-	AF-70P	AF-11	
	MINI 126	1974-		AF-12	
	M.METALLICA	-	LF-80	UN-FS	
	M.T.CLUBMAN	-	LF-80P		
	MINI MATIC	1976-	LF-8L	AF-10 UN-FS AF-11 AF-12 UN-FS	
	REGENT	-	LF-8L	UN-FT	
	INTER. HARVESTER	T. TERRENO	-	GM-6 GM-4P GM-A GM-AP	GM-10 GM-10P GM-B GM-8P
VARIOS - SEVERAL		1940-1975	KIN-1	KIN-1	
4.0 I		-1993	GM-9	OP-R	
			GM-9P	OP-8P	
	GM-J		OP-T		
	GM-JP		OP-TP		
	OP-R		OP-R		
4.0 I	1981-1986	OP-8P	OP-8P		
		OP-T	OP-T		
4.0 I	1986-	OP-WWP	OP-WWP		
		OP-WYP	OP-WYP		
SUZUKI	AMIGO	1988-1991	GM-4	GM-4	
	TI	1988-1991	GM-4P GM-4P1	GM-4P GM-4P1	
	AMIGO	1991-1994	GM-15D	GM-15D	
	RODEO	1991-1994	GM-15DP	GM-15DP	
	D-MAX	2002-2006	ISU-3DP	ISU-3DP	
	I-MARK	1985-1991	GM-2 GM-2P	GM-2 GM-2P	
	IMPULSE	1985-1991	MIT-2I	MIT-2I	
	PLAZZA	1985-1991	MIT-2IP	MIT-2IP	
	TROOPER	1985-1991			
	IMPULSE	1992-	GM-5	GM-5	
	STYLUS	1992-	GM-5P	GM-5P	
	MODELOS - MODELS	1981-1984	MIT-1I MIT-1IP	MIT-1I MIT-1IP	
	TROOPER	1982-1984	TOYO-14 TOYO-14P	TOYO-14 TOYO-14P	
	TROOPER	1991-	GM-1P	GM-1P	
	VEHY-CROSS	1994-2002	SUZU-10P	SUZU-10P	
	JAGUAR	E	1926-1924	FO-B FO-FB FO-FBP WAS-2P	UN-4 UN-1FS UN-FS UN-FT
		MAJESTIC	1989-1994	JAU-1P	JAU-1P
SOVEREIGN		1989-1994			
WANDEN PLAS		1989-1994			
XJ6		1989-1994			



MARCA BRAND	MODELO MODEL				
JAGUAR	XJS	1988-			
	XJ6	1971-1975	FO-B FO-FB FO-FBP WAS-2P	UN-4 UN-1FS UN-FS UN-FT	
	XJ6	1976-1978	FO-FB FO-FBP WAS-2P	FO-5	
	XJ6-12	1979-1987	FO-FB FO-FBP WAS-2P	CEM-JC	
	XJS	1975-	FO-FB FO-FBP WAS-2P	UN-FT	
	XJS	1976-	FO-FB	LF-WB	
	XJS	1978-1987	FO-FBP WAS-2P		
	XJS	1976-1977	LF-WB	FO-TC	
	JEEP	BRIAR WOOD	1991-1992	CHR-9	CHR-9
		CHEROKEE	1991-1992	CHR-9P	CHR-9P
COMANCHE		1991-1992			
LAREDO		1991-1992			
LTD		1991-1992			
WRANGLER		1991-1992			
CHEROKEE		1993-1998	CHR-10	CHR-10	
COMANCHE		1993-	CHR-10P	CHR-10P	
COUNTRY		1993-			
G.CHEROKEE		1993-1998			
G.WAGONEER		1993-			
LAREDO		1993-			
LTD		1993-			
RENEGADE		1993-			
SAHARA		1993-			
SPURR		1993-			
WAGONEER		1993-			
WRANGLER		1993-			
COMANCHE		1985-1998	GM-9		
PIONEER		-1991	GM-9P		
SCRAMBLER	1985-1998	GM-J			
WAGONEERS	1985-1998	GM-JP			
WRANGLER	1985-1998				
COMMANDO D	-	FIM-3I	CL-4I		
RENEGADE	1979-1984	GM-9 GM-9P GM-J GM-JP	VA-11D		
VARIOS - SEVERAL	1940-1973	KIN-1	KIN-1		
JENSEN	INTERCEPT 2	-	FO-FB	UN-FS	
	INTERCEPT 3	-	FO-FBP		
KIAWORTH	VARIOS - SEVERAL	1960-1987	KIN-1	KIN-1	
	VARIOS - SEVERAL	1960-1986	HUD-1	HUD-1	
KIA	CARNIVAL	1990-	KI-3DP	KI-3DP	
	CLARENCE	2001-			
	CLARUS	1998-2001			
	PRIDE	1990-			
	RIO	2001-			
	SHUMA	1998-2000			
	SORENTO	1998-			
	PRIDE 1.1 L	1992-1994	KI-10	KI-10	



AUTOMÓVIL - CAMIONETA

CAR - PICK-UP TRUCKS

MARCA BRAND	MODELO MODEL			
KIA	PRIDE 1.3 LX	1992-1994	KI-10P	KI-10P
	SEPHIA (USA)	1994-1995		
	SEPHIA 1.6 I	1993-1994		
	SPORTAGE	1995-1996		
	SEPHIA (USA)	1994-	KI-10P1	KI-10P1
	SPORTAGE USA	1996-	KI-2D	KI-2D
LA FORZA	FORZA 5.9 V6	1989-		GI0B-3P
LAGA VAL	1200	1972-	NE-3	IMS-3
	1300	1972-	NE-3P	IMS-3P
	1500	1972-	NE-3P1	IMS-3
	1600	1972-	NE-3P2	IMS-3P
	2101	1972-		
	2102	1972-		
	2103	1972-		
	2104	1972-		
	2105	1972-		
	2106	1972-		
	2107	1972-		
	21011	1972-		
	21003	1972-		
	21001	1972-		
	NIVA	-		
	BIVA	-		
	3110	-	LA-3D	LA-7
			LA-3DP	LA-2P
			LA-4D	
			LA-4DP	
4x4	-	LA-1D	LA-1D	
4x4 GLARGE	-	LA-1DP	LA-1DP	
KAMA	1984-	LA-7	LA-7	
SAGONA	-	LA-3P	LA-3P	
		LA-3D	LA-3D	
		LA-3DP	LA-3DP	
CARLOTA	1991-	LA-1D	LA-1D	
SAMARA	1991-1992	LA-1DP	LA-1DP	
NIVA 1.6	1992-	NE-3	IMS-3	
		NE-3P	IMS-3P	
		NE-3P1		
		NE-3P2		
SAMARA	1992-	LA-3D	LA-7	
		LA-3DP	LA-2P	
LAMBORGHINI	COUNTACH	-	AF-7I	IMS-3
	DIABLO COU.	-	AF-7IP	IMS-3P
	DIABLO ROA.	-	AF-7IP1	IMS-3
	JALPA	-		IMS-3P
	URRACO	-		
	ESPADÁ	-	AF-7I	AF-6I
			AF-7IP	AF-6I
			AF-7IP1	
	MIURA	-	8H-1	AF-4D
			8H-1P	AF-4I
				AF-5D
				AF-5I
				AF-6D
				AF-6I
LANCIA	2000	-1972	GI0B-1D	GI0B-3I
	APPIA	-1972	GI0B-1DP	GI0B-3IP
	FLAVIA	-1972		
	FULVIA	-1972		

MARCA BRAND	MODELO MODEL			
LANCIA	2000	1972-	GI0B-1D	GI0B-3I
	FULVIA	1972-	GI0B-1DP	GI0B-3IP
			SUP-3	
	BETA	1972-1982	AF-7I	GI0B-3P
	DELTA	1979-1982	AF-7IP	
	GAMMA	1972-1982	FI-9I	
			FI-9IP	
	BETA	1975-1980	AF-7I	AF-10
	MONTECARLO	1975-1980	AF-7IP	AF-11
				AF-12
	DEDRA	1989-1995	FI-13	FI-13
	DEDRA S.W.	1994-	FI-13P	FI-13P
	DELTA	1983-1995	FI-14P	FI-14P
	DELTA	1983-	FI-3D	GI0B-3P
			FI-3DP	
			FI-3DP3	
			FI-6I	
			FI-6IP	
			FI-6IP3	
	DELTA	1984-1992	FI-11	GI0B-3P
PRISMA	1984-1989	FI-10P		
		FI-11P		
LANCIA Z	1994-	SIX-3P1	SIX-3P1	
Z 2000	1994-			
THEMA	1984-	FI-10	FI-10	
		FI-10P	FI-10P	
		FI-11	FI-11	
		FI-11KP	FI-11KP	
		FI-11P	FI-11P	
TREVI	1989-	FI-9I	GI0B-3P	
		FI-9IP		
LAND RANGE ROVER	88	1982-1983	LF-8D	UN-FS
	88	1984-	LF-8DP	
	109	1982-1983		
	109	1984-		
	118	1984-1985		
	88	1985-1987	LF-8D	AB-6I
	109	1985-1987	LF-8DP	
	118	1986-1987		
	SANTANA	1985-1987		
	99	1985-1986	LF-8D	LF-8D
	118	1985-1986	LF-8DP	LF-8DP
	99	1987-1991	LF-8D	UN-FT
	118	1987-1991	LF-8DP	
	DEFENDER	1990-		
	99 2500	1989-1991	IMS-7	AB-6I
	99 2500	1989-1991	IMS-7P	
	118 2500	1985-1987		
	118 2500	1985-1987		
	SANTANA	1987-1991		
	DISCOVERY	1989-1993	NE-11	NE-11
		NE-11P1	NE-11P1	
		NE-11P2	NE-11P2	
DISCOVERY	1994-1997	NE-52P	NE-52P	
MOODOS - MODELS	1979-1972	UN-FS	UN-7P	
MOODOS - MODELS	1973-1981	UN-FS	UN-FS	
R.ROVER	-1982	UN-NH	UN-NH	
		UN-NHP	UN-NHP	
R.ROVER	1984-1988	NE-11	NE-11	

MARCA BRAND	MODELO MODEL			
LAND ROVER			NE-11P	NE-11P
			NE-11P1	NE-11P1
			NE-11P2	NE-11P2
			NE-24	NE-24
			NE-24P	NE-24P
			NE-24P1	NE-24P1
	R. ROVER	1989-1997	NE-11	NE-11
			NE-11P	NE-11P
LEXUS (TOYOTA)	250 ES	1989-	TOYO-18P	TOYO-18P
	300 ES	1989-		
	400 LS	1989-		
	COUPE 300 SC	1991-		
	COUPE 400 SC	1991-		
LOTUS	ECLAT	-	TOYO-K1	TOYO-K1
	EXCEL SE	-	TOYO-K1P	TOYO-K1P
	ELAN SE	1991-	OP-D	OP-D
			OP-DKP	OP-DKP
			OP-OP	OP-OP
	ESPRIT 2.2	-	LF-RO	UN-FT
	ESPRIT COUPE	1991-	LF-ROP	
	ESPRIT TURBO	-		
	MOOROS - MOORLS	-1976	FO-FB	UN-FS
			FO-FBP	UN-FT
		LF-RO		
		LF-ROP		
MAZDA	VARIOS - SEVERAL	1955-1969	KIN-1	KIN-1
	VARIOS - SEVERAL	1970-1986	HUD-1	HUD-1
MIRAGE	800	1991-1992	SUZU-7	SUZU-7
	800 LUXE	1991-1992	SUZU-7P	SUZU-7P
	800 S. LUXE	1991-1992		
MASERATI	BITURBO	1981-	LF-RO	AF-18
	GHIBLI	1980-	LF-ROP	AF-11
	KARIF	1980-		AF-12
	QUATTROPORTE	1976-1980		
	SHAMAL	1980-		
	SPYDER	1980-		
	BORA	1971-1976	AF-7I	RO-5D
			AF-7IP	
			AF-7IP1	
	GHIBLI 5000	-		IMS-3
				IMS-3P
	INDY 4000 A.	1969-	AF-7I	GIOB-3I
			AF-7IP	GIOB-3IP
			AF-7IP1	RO-5D
	KHAMSIN	1972-	AF-7I	IMS-3
			AF-7IP	IMS-3P
			AF-7IP1	IMS-5
			IMS-5P	
KYALAMI	1976-	FO-2	IMS-5	
			IMS-5P	
MERAK	1972-1976	CT-3	RO-5D	
		CT-3P		
MAZDA	121	1988-1990	MAZ-3D	MAZ-3D
	323	1983-1989	MAZ-6DP	MAZ-6DP
	323 S.W.	1986-1996		
	626	1987-1991		
	626 S.W.	1986-1992		
	727	1987-1991		
	929 S.W.	1982-		



MARCA BRAND	MODELO MODEL			
MAZDA	COSMO	1984-1986		
	MX6	1986-1989		
	RX7	1987-1993		
	121	1991-1992	MAZ-5D	MAZ-5D
			MAZ-5DP	MAZ-5DP
			MAZ-7D	MAZ-7D
			MAZ-7DP	MAZ-7DP
	121	1990-1994	MAZ-13D	MAZ-13D
	323	1992-1994	MAZ-13DP	MAZ-13DP
	MX3	1992-1995	MAZ-13DP1	MAZ-13DP1
	MX5	1992-1995	MAZ-7D	MAZ-7D
	RX7	1992-	MAZ-7DP	MAZ-7DP
	XEDOS	1992-1996		
	121	1996-	FO-6P	FO-6P
	323	1977-1982	MAZ-2D	MAZ-2D
	323 S.W.	1977-1986	MAZ-2DP	MAZ-2DP
	626	1978-1982		
	929	1980-1982		
	929 S.W.	1980-1982		
323	1982-1983	MAZ-3D	MAZ-3D	
		MAZ-3DP	MAZ-3DP	
		MAZ-3I	MAZ-3I	
		MAZ-3IP	MAZ-3IP	
323	1984-1992	MAZ-3D	MAZ-3D	
		MAZ-7D	MAZ-7D	
		MAZ-7DP	MAZ-7DP	
323	1995-		MAZ-7DP1	
MX3	1995-			
MX5	1995-			
323 S.F.	1982-	NE-23	MAZ-2D	
		NE-26	MAZ-2DP	
			MAZ-3I	
			MAZ-3IP	
323 S.P.	1990-	MAZ-7D	MAZ-7D	
MPV	1980-	MAZ-7DP	MAZ-7DP	
MX5 (EU)	1990-1992			
MX6	1990-1992			
616 CAP.	-1978	DAT-3I	MAZ-2D	
616 SNA	-1978		MAZ-2DP	
RX2 CAPPE.	1979-1971			
616 CAPE.	1971-1973	DAT-11D	MAZ-2D	
616	1971-1973	DAT-11DP	MAZ-2DP	
RX2 CAPPE.	1974-1977	WAS-3P		
RX3	1974-1977			
626	1982-1987	MAZ-3D	MAZ-3D	
929	1982-1986	MAZ-3DP	MAZ-3DP	
		MAZ-3I	MAZ-3I	
		MAZ-6DP	MAZ-6DP	
		MAZ-6P	MAZ-6P	
626	1991-	MAZ-7D	MAZ-7D	
MX3	1991-1992	MAZ-7DP	MAZ-7DP	
		MAZ-7DP1	MAZ-7DP1	
626	1991-1995	MAZ-13D	MAZ-13D	
MX6	1992-1995	MAZ-13DP	MAZ-13DP	
		MAZ-13DP1	MAZ-13DP1	
626	1995-1997		MAZ-13D	
MX6	1995-1997		MAZ-13DP	
XEDOS 6	1995-1997		MAZ-13DP1	
626 GL	1991-	CHR-3	MAZ-2D	



AUTOMÓVIL - CAMIONETA

CAR - PICK-UP TRUCKS

MARCA BRAND	MODELO MODEL				
MAZDA			NI-2P2	MAZ-20 P	
	B26 S.W.	1993-1996	MAZ-5D	MAZ-5D	
	BX7	1991-	MAZ-5DP	MAZ-5D P	
	B98	1971-1977	DAT-11D	MAZ-2D	
	B18	1971-1977	DAT-11DP	MAZ-2D P	
	B25	1973-1988	WAS-2P	MAZ-2I MAZ-2IP	
	B18 1.3	-1971	DAT-2I	MAZ-1I	
	B18 1.5	-1971			
	1800	1971-1972			
	B29 GLX	1987-	MAZ-3D	MAZ-3D	
	BX7	1983-1986	MAZ-3DP MAZ-6DP	MAZ-3D P MAZ-6D P	
	1200	1978-1972	DAT-11D	MAZ-1I	
	1800	1978-1971	DAT-11DP WAS-2P		
	1600	1972-	DAT-2I	MAZ-1D	
	B 188	1978-1971			
	ARTIS	-	MAZ-21DP1	MAZ-21DP1	
	B 1888	1978-1971	MAZ-1I	MAZ-1I	
	COSMO	1975-1979	MAZ-16	MAZ-16	
	COSMO	1988-	MAZ-3D	MAZ-3D	
	GLC 323	1983-1989	MAZ-3DP	MAZ-3D P	
	COSMO	1982-1983	MAZ-3D MAZ-3DP MAZ-3I MAZ-6P	MAZ-3D MAZ-3D P MAZ-3I MAZ-6P	
	E 1000	1986-	MAZ-2D MAZ-2DP MAZ-2I MAZ-2IP MAZ-3D MAZ-3DP MAZ-3I MAZ-3IP	MAZ-2D MAZ-2D P MAZ-2I MAZ-2IP MAZ-3D MAZ-3D P MAZ-3I MAZ-3IP	
	EUNOS 800	1993-	TOYO-18P	TOYO-18P	
	XEDOS 9	1993-1996			
	MAZDA	1989-1992	MAZ-3D	MAZ-3D	
	MX5	1989-1992	MAZ-7D MAZ-7DP MAZ-7DP1	MAZ-7D MAZ-7D P MAZ-7D P1	
	MOORLOS - MOORLS	1978-1974	MAZ-14D	MAZ-14D	
	MOORLOS - MOORLS	1975-1984	MAZ-1D MAZ-1I	MAZ-2D MAZ-3D P MAZ-3I MAZ-3IP	
	NAVAJO	1991-	MAZ-8D MAZ-8DP	MAZ-8D MAZ-8D P	
	B 188	1972-	DAT-11D	MAZ-1D	
	B 1200	1972-	DAT-11DP WAS-2P		
	BX2	1972-1973	DAT-11D DAT-11DP WAS-2P	MAZ-2I MAZ-2IP	
	BX4 LUCE	1972-1978	MAZ-2D	MAZ-2D	
	BX5 COSMO	1972-1978	MAZ-2DP	MAZ-2D P	
	BX7 COUPE	1972-1978	MAZ-2I MAZ-2IP	MAZ-2I MAZ-2IP	
	MERCEDES	T8C	1993-	ME-2P	ME-2P



MARCA BRAND	MODELO MODEL			
MERCEDOS	280C	1993-	ME-4P	ME-4P
	220C	1993-		
	280C	1993-		
	380C	1993-		
	190	1984-1986	ME-10P	ME-10P
	200	1984-	ME-2P	ME-2P
	230	1984-	ME-3P	ME-3P
	250	1984-	ME-4P	ME-4P
	260	1984-	ME-5P	ME-5P
	280	1979-	ME-6P	ME-6P
	300	1988-		
	360	1984-		
	380	1979-		
	420	1984-		
	450	1979-		
	500	1979-		
	508	1984-		
	1900	1984-		
	190	1986-	ME-4P	ME-4P
			ME-5P	ME-5P
	190 ALARM	1986-1992	ME-10P ME-11P ME-12P	ME-10P ME-11P ME-12P
	200	1973-1974	ME-HD	ME-HD
	220	1973-1974	ME-HDP	ME-HDP
	230	1973-1974	ME-HF	ME-HF
	240D	1973-1976	ME-HFP	ME-HFP
	250	1973-1977	ME-HM	ME-HM
	280	1973-1974	ME-HMP	ME-HMP
	350	1973-	ME-HZ	ME-HZ
	380	1973-1977	ME-HZP	ME-HZP
	450	1973-1976		
	200	1974-1975	ME-HD	ME-HD
	220	1974-	ME-HDP	ME-HDP
	230	1974-1977	ME-HZ	ME-HZ
	340	1974-1977	ME-HZP	ME-HZP
	280	1974-1979		
	200	1975-1976	ME-HF ME-HFP ME-HM ME-HMP	ME-HF ME-HFP ME-HM ME-HMP
	200	1976-1977	ME-HU	ME-HU
	240D	1976-	ME-HUP	ME-HUP
	300D	1976-	ME-NU ME-NUP	ME-NU ME-NUP
	200	1977-1984	ME-HU	ME-HU
	230	1977-1984	ME-HUP	ME-HUP
	240	1977-	ME-HY	ME-HY
	250	1977-1984	ME-HYP	ME-HYP
	300	1977-1988	ME-NU ME-NUP	ME-NU ME-NUP
	380	1977-1979	ME-NY ME-NYP	ME-NY ME-NYP
260D	-	ME-VA	ME-VA	
360D	-			
287D	-1992	ME-HM	ME-HM	
287F	-1992	ME-HMP	ME-HMP	
287K	-1992			
288D	-1992			



MARCA BRAND	MODELO MODEL				
MERCEDÉS	2000	-1992			
	3070	-1992			
	3000	1992-			
	L 500	-1991			
	L 600	-1991			
	LN 914	-1991			
	MB 3000T	-1991			
	MB 4000T	-1991			
	U 900	-1991			
	U 1700	-1991			
	230	-1972	ME-HF	ME-HF	
	230	-1972	ME-HFP	ME-HFP	
	250	-1972	ME-HZ	ME-HZ	
	280	-1972	ME-HZP	ME-HZP	
	300	-1972			
	350	-1972			
	7700	-1972			
	230	-	ME-HF	ME-HF	
	240	-	ME-HFP	ME-HFP	
	280	-	ME-HM	ME-HM	
	300	-	ME-HMP	ME-HMP	
	TOD0 T. 4WD	-	ME-HZ	ME-HZ	
			ME-HZP	ME-HZP	
	400	-1994	ME-3P	ME-3P	
	600	-1994	ME-3P	ME-3P	
	711	1990-	ME-HMP	ME-HMP	
	814	1990-			
	817	1990-			
	917	1990-			
	1117	1990-			
	1300	1990-			
	1500	1990-			
	SPRINTER	1990-			
	VARIO	1990-			
	MB 1000	-1994	ME-1	ME-1	
		ME-1P	ME-1P		
VITO	1990-	ME-HMP	ME-HMP		
		ME-HZ	ME-HZ		
		ME-HZP	ME-HZP		
VITO	1997-	ME-HMLP	ME-HMLP		
MG	MG	1970-1974	UN-NH	UN-FS	
	MOB	1970-1974	UN-NHP		
	MOB GT	1970-1975			
	MG	1975-1977	NE-1	UN-FS	
	MOB	1975-1978	NE-1P		
	MG	1978-	NE-1B	UN-FS	
			NE-1BP	UN-FT	
	MGF	1997-	NE-1BP	NE-1BP	
	MOOKOS-MOOKS	-1978	UN-FF	UN-FF	
			UN-FS	UN-FS	
MITSUBISHI	3000 GT/USL	-	MIT-12	MIT-12	
	BRAVO	-	MIT-7	MIT-7	
	CHARLOT	1987-	MIT-3P	MIT-3P	
	COLT	1987-1993			
	DIAMANTE	1992-			
	ECLIPSE	1987-			
	ETERNA	1989-			
	EXPO	-			
	GALANT	1987-1996			



MARCA BRAND	MODELO MODEL			
MITSUBISHI	L 200	1987-		
	L 300	1987-		
	LANCER	1987-1996		
	MINICAB	1987-		
	MIRAGE	1987-1993		
	MONTERO	1992-1996		
	MX SUPER A.B	-		
	RUMBUS	1987-		
	PAJERO	1992-1996		
	S.BUNNER	1992-1998		
	SHOGUN	-		
	SPACE GEAR	1996-		
	SPACE WAGON	1996-		
	CANTER	1997-	MIT-15P	MIT-15P
	CELESTE	1972-1980	MIT-11	MIT-11
	COLT	1972-1980	MIT-10P	MIT-10P
	GALANT	1972-1980		
	LAMBDA	1972-1980		
	LANCER	1972-1980		
	MINICA	1972-1980		
	STARION	1972-1980		
	COLT	1981-1984	MIT-21	MIT-21
	CORDIA	1981-1984	MIT-21P	MIT-21P
	DEBONAIR	1981-1984		
	ETERNA	1981-1983		
	GALANT	1981-1983		
	L 300	-1983		
	L 300 VAN	1981-1984		
	LANCER	1981-1983		
	MINICA	1981-1983		
	MONTERO	1981-1992		
	PAJERO	1981-1992		
	SAPPORO	1981-1984		
	SHOGUN	1981-1984		
	SKIMA	1981-1984		
	SPACE WAGON	1981-1983		
	STARION	1981-1983		
	VISTA	-1993		
	COLT	1984-1987	MIT-3	MIT-3
	DEBONAIR	1982-1985	MIT-3P	MIT-3P
	ETERNA	1982-1989	MIT-4	MIT-4
	GALANT	1982-1987	MIT-4P	MIT-4P
	L 300	1982-1987		
	LANCER	1982-1987		
	MINICA	1982-1987		
ORCHID	1982-1985			
SPACE WAGON	1982-1985			
STARION	1982-1985			
TREDIA	1982-1985			
COLT	1993-1996	MIT-130	MIT-130	
MIRAGE	1993-	MIT-140	MIT-140	
		MIT-80	MIT-80	
		MIT-80P	MIT-80P	
INTERCOOLER	1992-	CHR-17	CHR-17	
		MIT-12	MIT-12	
		MIT-7	MIT-7	
		MIT-3P	MIT-3P	
L 600	1992-	MIT-3P	MIT-3P	
MOOKOS-MOOKS	1986-1986	MIT-5	MIT-5	



AUTOMÓVIL - CAMIONETA

CAR - PICK-UP TRUCKS

MARCA BRAND	MODELO MODEL				
MITSUBISHI			MIT-5P	MIT-5P	
			MIT-6	MIT-6	
			MIT-6P	MIT-6P	
	PRECIS	1980-	HY-3D	HY-3D	
			HY-3DP1	HY-3DP1	
	SUMMIT	1993-	MIT-8D	MIT-8D	
VISTA	1993-	MIT-8DP	MIT-8DP		
MOSKVITCH	400	-	NE-3	MOS-1	
	412	-	NE-3P	VOL-3	
	426	-	NE-3P1		
	427	-	NE-3P2		
	2136	-			
	2136	-			
	2137	-			
	2138	-			
	2140	-			
	2141 ALERO	-	LA-3D	LA-3D	
			LA-3DP	LA-3DP	
	NISSAN	200 SX	-1983	DAT-12	DAT-12
		200 Z	-1983	DAT-6	DAT-6
		200 Z	-1983	DAT-6P	DAT-6P
200 L		-1983	DAT-7	DAT-7	
200 ZX		-1983	DAT-7P	DAT-7P	
AUSTER		-1983			
ACCESS		-1983			
BLUEBIRD		-1983			
CEDRIC		-1983			
CHERRY		-1983			
EXA		-1983			
FAIRLADY		-1983			
GAZELLE		-1983			
GLORIA		-1983			
LANGLEY		-1983			
LAUREL		-1983			
LEOPARD		-1983			
LIBERTA VIL		-1983			
MARCH		-1983			
MAXIMA		-1983			
MICRA		-1983			
PRO		-1983			
PINTARA		-1983			
PRAIRIE		-1983			
PRESIDENT		-1983			
PULSAR		-1983			
SENTRA		-1983			
SILVIA		-1983			
SKYLINE		-1983			
STANZA		-1983			
SUNNY		1983-1989			
TULIP		-1983			
VANETTE	-1983				
VIOLET	-1983				
200 Z	1969-1973	DAT-5D	DAT-1D		
200 Z	1969-1973		DAT-1DP		
BLUEBIRD	1977-1979				
CHERRY	1977-1979				
SENTRA	1977-1979				
SKYLINE	1977-1979				
SUNNY	1977-1979				

MARCA BRAND	MODELO MODEL			
NISSAN	VIOLET	1977-1979		
	200 Z	1974-1983	DAT-5D	DAT-2D
	200 Z	1974-1983		DAT-2DP
	200 Z	1974-1983		DAT-2I
	200 ZX ST.W	1974-1983		DAT-2IP
	1200 DE LUXE	-1971		DAT-4I
	1200 VAN	-1971		
	1200 DE LUXE	1971-1973	DAT-8	DAT-7
			DAT-8P	DAT-7P
	BLUEBIRD	1976-1986	DAT-5D	DAT-6
	CHERRY	1976-1986		DAT-8I
	SENTRA	1976-1986		DAT-8IP
	SKYLINE	1976-1986		DAT-8IP1
	SUNNY	1976-1986		DAT-8P
	VIOLET	1976-1986		
	BLUEBIRD	1976-1979	DAT-1D	DAT-1D
			DAT-1DP	DAT-1DP
			DAT-1I	DAT-1I
			DAT-1IP	DAT-1IP
	BLUEBIRD	1980-1982	DAT-5D	DAT-5D
			DAT-5DP	DAT-5DP
			DAT-5I	DAT-5I
			DAT-5IP	DAT-5IP
	CEDRIC	1986-1993	DAT-15	DAT-15
	GLORIA	1986-1993	DAT-15P	DAT-15P
	PATHFINDER	1986-1993	DAT-16	DAT-16
	CHERRY	1986-1982	NE-11	DAT-1D
			NE-11P	DAT-1DP
				DAT-1I
				DAT-1IP
	FLORIDA	1989-1991	DAT-6	DAT-6
	PATROL 4x4	1989-	DAT-6P	DAT-6P
SUNNY	1989-1991			
TERRANO	1989-1995			
TRADE	1989-			
MAXIMA	1989-1992	DAT-2D	DAT-2D	
		DAT-2DP	DAT-2DP	
		DAT-2I	DAT-2I	
		DAT-2IP	DAT-2IP	
MAXIMA	1991-1995	DAT-18	DAT-7	
		DAT-18P		
MICRA	1993-1995	DAT-18	DAT-18	
PRIMERA	1991-1995	DAT-18P	DAT-18P	
TERRANO	1995-			
TERRANO II	1993-1995			
PATHFINDER	1991-	DAT-12	DAT-12	
SENTRA	1991-			
PATROL 4 WD	-1985	DAT-8	DAT-8	
		DAT-8P	DAT-8P	
QUEST	1993-	FO-8D	FO-8D	
		FO-8DP	FO-8DP	
		FO-8DP1	FO-8DP1	
QUEST	1993-1994	DAT-19	DAT-19	
		DAT-19P	DAT-19P	
QUEST	1996-	DAT-28	DAT-28	
		DAT-28P	DAT-28P	
SERENA	1993-1996	DAT-6	DAT-6	
		DAT-6P1	DAT-6P1	
URVAN	-1994	DAT-12	DAT-12	

MARCA BRAND	MODELO MODEL			
NISSAN				DAT-10 DAT-10P
	VANETTE	1983-1996	DAT-12	DAT-12
			DAT-6	DAT-6
			DAT-6P	DAT-6P
			DAT-7	DAT-7
NISSAN (AUSTRALIA)	PINTARA	-1983	DAT-12	DAT-12
	PULSAR	-1983	DAT-6	DAT-6
			DAT-6P	DAT-6P
			DAT-7	DAT-7
			DAT-7P	DAT-7P
NISSAN (USA)	818	1988-1992	DAT-20	DAT-20
			DAT-20P	DAT-20P
			DAT-21	DAT-21
			DAT-21P	DAT-21P
			DAT-21P	DAT-21P
	818	1983-	DAT-12	DAT-12
			DAT-6	DAT-6
			DAT-6P	DAT-6P
			DAT-7	DAT-7
			DAT-7P	DAT-7P
OM VEICO	48	-	AF-9D	AF-5D
			AF-9DP	AF-5I
			AF-9I	AF-6D
			AF-9IP	AF-6I
	58.18	1979-1981	LF-80	IMS-3
	68.18	1979-1981	LF-80P	IMS-3P
	68.18	1979-		IMS-5
	78.18	1979-		IMS-5P
	88.18	1981-	SIP-1	IMS-3
	88.18	1981-		IMS-3P
	78.18	1981-		IMS-5
	75.18	1981-		IMS-5P
	78.18	1981-		
	79.13	1981-		
	75	-	AF-9D	FI-5D
			AF-9DP	FI-5I
			AF-9I	IMS-3
			AF-9IP	IMS-3P
			FEM-10	IMS-5
			FEM-11	IMS-5P
108.13	-	AF-9D	IMS-3	
108	-	AF-9DP	IMS-3P	
108.26	-	AF-9I	IMS-5	
		AF-9IP	IMS-5P	
		AF-9D		
		AF-9DP		
		AF-9I		
		AF-9IP		
108.13	-1978	AF-9D	IMS-3	
118.11MP	-1978	AF-9DP	IMS-3P	
118.13	-1978	AF-9I	IMS-5	
138	-1978	AF-9IP	IMS-5P	
		FEM-10		
		FEM-11		
138	-	FEM-10	IMS-3	
138 B	-	FEM-11	IMS-3P	
138 B/H	-		IMS-5	
138 T/H	-		IMS-5P	
158 R2H	-	AF-9D	FI-5D	
158 T2H	-	AF-9DP	FI-5I	

MARCA BRAND	MODELO MODEL			
OM VEICO	158.26	-	AF-9I	IMS-3
	158.26	-	AF-9IP	IMS-3P
	198 T3H	-		IMS-5
	198.26	-		IMS-5P
	198.26	-	AF-7I	IMS-3
	198.26	-	AF-7IP	IMS-3P
	198.26 TUR.	-	AF-9D	IMS-5
			AF-9DP	IMS-5P
			AF-9I	
			AF-9IP	
	338.26	-	VO-V8	IMS-3
	338.26	-	VO-V8P	IMS-3P
				IMS-5
				IMS-5P
	DAINO 145	-	BH-4	AF-5D
	LUPETTO	-		AF-5I
				AF-6D
				AF-6I
	GRINTA	-	AF-7I	IMS-3
			AF-7IP	IMS-3P
			FI-9I	IMS-5
			FI-9IP	IMS-5P
			LF-80	
			LF-80P	
	LEONCINO	-	BH-4	AF-6D
			AF-6I	
ORSETTO	-	FEM-10	AF-5D	
		FEM-11	AF-5I	
			AF-6D	
			AF-6I	
OPEL VAUXHALL	ADMIRAL	-1933	OP-6	OP-6
	KADETT	-1933	OP-7	OP-7
	OLIMPIYA	-1933	OP-8	OP-8
	REKORD	-1933	OP-9	OP-9
			OP-8B	OP-8B
			OP-EE	OP-EE
			OP-FF	OP-FF
	ASCONA	-1934	OP-9A	OP-9A
	MANTA	-1934	OP-9B	OP-9B
			OP-9C	OP-9C
			OP-9H	OP-9H
	ASCONA	1975-1981	OP-AB	OP-AB
	KADETT	1973-1983	OP-ABP	OP-ABP
	MANTA	1975-1981	OP-BA	OP-BA
OP-BAP			OP-BAP	
OP-J			OP-J	
OP-JP			OP-JP	
ASCONA	1982-	OP-WHP	OP-WHP	
CALIBRA	1987-1995	OP-WYP	OP-WYP	
CARAVAN	1982-			
COMMODORE	1982-			
MANTA	1982-			
MONZA	1984-			
OMEGA	1987-1995			
REKORD	1984-			
VECTRA	1987-1995			
ASTRA	1991-1995	OP-D	OP-D	
CORSA	1984-1995	OP-DKP	OP-DKP	
CORSA VAN	1984-1995	OP-DP	OP-DP	

AUTOMÓVIL - CAMIONETA

CAR - PICK-UP TRUCKS

MARCA BRAND	MODELO MODEL			
OPEL-Vauxhall	KADETT	1984-	OP-S	OP-S
			OP-SXP	OP-SXP
			OP-SP	OP-SP
	ASTRA VAN COMBO	1991-1995	OP-D	OP-D
			OP-DKP	OP-DKP
	FRONTERA MONTEBEY	1992-1996	GM-4	GM-4
			GM-4P	GM-4P
			GM-4P1	GM-4P1
	MANTA 1.8	1975-1979	OP-J	OP-J
			OP-JP	OP-JP
	MIDI	1992-	MIT-3	MIT-3
			MIT-3P	MIT-3P
	MONZA	1974-1981	OP-R	OP-R
	REKORD	1974-1984	OP-RP	OP-RP
	SENATOR	1984-	OP-T	OP-T
			OP-TP	OP-TP
	MONZA	1981-1984	GM-5	OP-R
	SENATOR	1981-1984	GM-5P	OP-RP
			GM-J	OP-T
GM-JP			OP-TP	
TIGRA	1994-	OP-SP1	OP-SP1	
PEUGEOT	104	1972-	LMP-1	VA-4
			LMP-1P	VA-4P
			NE-4	
			NE-4P	
	104	1976-	NE-4	NE-4
	504	1975-	NE-4P	NE-4P
	604	1975-1980	NE-4P1	NE-4P1
	104	1975-	LMP-2	LAS-V
			LMP-2P	VA-6
			NE-4	VA-6P
			NE-4P	
	104	1980-	CHR-3	CHR-3
	104	1982-	CHR-3P	CHR-3P
	305	1978-1988	NE-22P1	NE-22P1
	305	1983-1987		
	505	1979-1988		
	505 BREAK	1981-1983		
	604	1981-		
	104	1981-	LMP-4	LMP-4
	505 BERLINA	1981-1983	LMP-4P	LMP-4P
			LMP-5	LMP-5
			LMP-5P	LMP-5P
	106	1991-1997	NE-36	NE-36
			NE-36KP1	NE-36KP1
			NE-36P1	NE-36P1
	106 SERVICE	- 1993	NE-18	NE-18
	305 SERVICE	- 1993	NE-28P1	NE-28P1
	305 SERVICE	1985-		
	405 AFFAIRE	1987-1991		
	204	1965-	NE-37	VA-4
	304	1969-1978	NE-37P	VA-4P
	404	1965-	NE-4	
	504 BERLINA	1968-1974	NE-4P	
NE-4P1				
205	1984-	NE-28	NE-28	

MARCA BRAND	MODELO MODEL					
PEUGEOT			NE-28P	NE-28P		
			NE-28	NE-28		
			NE-28P	NE-28P		
	205	1985-1991	NE-28	NE-28		
	505	1985-	NE-28P1	NE-28P1		
			NE-28	NE-28		
	205	1991-1993	NE-28	NE-28		
			405	1991-1993	NE-28P1	NE-28P1
			NE-28	NE-28		
			NE-36	NE-36		
			NE-36KP1	NE-36KP1		
	205	1993-	NE-36P1	NE-36P1		
			405	1993-	NE-36	NE-36
			NE-36KP1	NE-36KP1		
			NE-36P1	NE-36P1		
			305	1981-1982	SIX-1	SIX-1
			SIX-1KP	SIX-1KP		
			SIX-1P1	SIX-1P1		
			305 SERVICE	1982-	CHR-3	CHR-3
	305	1983-1987	NE-22P1	NE-22P1		
			305	1985-	NE-28	NE-28
			405	1982-1991	NE-28P1	NE-28P1
			NE-28	NE-28		
			NE-28P	NE-28P		
	405	1985-1987	NE-51P2	NE-51P2		
	504 BREAK	1968-1974	NE-4	RO-11D		
			NE-4P			
	504 PICK UP	1975-	NE-4	NE-4		
			NE-4P1	NE-4P1		
	505	1984-	NE-28	NE-28		
	505 SERVICE	1979-	NE-28P	NE-28P		
			CHR-3	LAS-R		
	605	1986-	NE-22P1	LAS-V		
605			1988-	NE-34P	NE-34P	
805	1994-	SIX-3P1	SIX-3P1			
J-5	-	FI-12	FI-12			
		FI-12P3	FI-12P3			
		FI-3D	FI-3D			
		FI-3DP3	FI-3DP3			
		FI-6I	FI-6I			
J-7	-	FI-6IP3	FI-6IP3			
		NE-4				
J-9	-	NE-4P1				
		RO-4D	RO-4D			
PARTNER	1997-	RO-4I	RO-4I			
		RO-5D	RO-5D			
RANCH	1997-	SIX-3P1	SIX-3P1			
PEUGEOT (ARGENT.)	-	SIX-3P2	SIX-3P2			
		NE-3	NE-3I			
		NE-3P				
405	-	NE-3P2				
		NE-28	NE-28			
		NE-28P1	NE-28P1			

MARCA BRAND	MODELO MODEL			
PEUGEOT (ARGENTINA)	504	-	NE-3	NE-3
			NE-3P	NE-3P
			NE-3P2	NE-3P2
			NE-4	NE-4
			NE-4P	NE-4P
	504 PICK UP	-	NE-4	NE-4
			NE-4P	NE-4P
	505	-	NE-20	NE-20
			NE-20P1	NE-20P1
			NE-42	NE-42
			NE-42P	NE-42P
			NE-42P1	NE-42P1
PORTER	1993-1994	DAI-1P	DAI-1P	
PORSCHE	911 CARRERA	1970-	PO-NC	PO-NC
	912	1970-	PO-NCP	PO-NCP
	914	1970-	PO-NC	PO-NC
			PO-NCP	PO-NCP
	924	1975-1993	VO-3CP	VO-3CP
	944	1975-1993	VO-IV	VO-IV
			VO-IVP	VO-IVP
			VO-VB	VO-VB
			VO-VBP	VO-VBP
	928	1977-	PO-1P	PO-1P
		PO-2P	PO-2P	
PREMIER	110 NE	-	AF-7I	BMS-3
			AF-7IP	BMS-3P
			AF-9D	BMS-5
			AF-9DP	BMS-5P
			FEM-10	
			FEM-11	
			FEM-20	
			FEM-21	
			FO-FR	
			FO-FRP	
	SIP-2			
	PRADMINI	-	FEM-10	AF-4D
			FEM-11	AF-4I
			FEM-20	AF-10
			FEM-21	AF-11
			AF-4D	
		AF-4I		
MAGNUM 4x4	-	FI-1	FI-1	
		FI-11	FI-11	
		FI-11KP	FI-11KP	
		FI-11P	FI-11P	
		FI-1P	FI-1P	
MAGNUM FOXCA	-	GIOB-3P	GIOB-3P	
RENAULT	R 4	1961-1991	NE-4	NE-4
			NE-4P	NE-4P
			NE-4P1	NE-4P1
			NE-4P2	NE-4P2
	R 5	1972-1979	LMP-2	RO-15
			LMP-2P	VA-7
			NE-15D	
			NE-15DP	
			NE-15I	

MARCA BRAND	MODELO MODEL			
RENAULT	R 5	1979-	NE-15IP	
			NE-15D	NE-16
			NE-15DP	NE-50P
			NE-15I	
			NE-15IP	
	R 5	1980-	CHR-3	NE-16
			CHR-3P	NE-50P
			LMP-4	
			LMP-4P1	
	R 5	1981-	CHR-3	VA-18
	R 5	1982-1984	CHR-3P	
	R 5	1982-	CHR-3	VA-18
			CHR-3P	
			LMP-4	
			LMP-4P1	
			LMP-5	
			LMP-5P1	
	R 5	1985-1986	NE-19	VA-18
			NE-19P1	
	R 5	1986-	NE-19	NE-28
			NE-19P1	
	R 6	1988-	LMP-1	RO-15
			LMP-1P	
			NE-15I	
			NE-15IP	
R 7	-	NE-19	NE-16	
		NE-19P	NE-4	
		NE-4P2	NE-50P	
R 9	1981-	CHR-3	NE-16	
R 11	1981-	CHR-3P	NE-50P	
		LMP-5		
		LMP-5P1		
R 9	1982-1983	CHR-3	BS-5	
R 11	1982-1983	CHR-3P	NE-16	
			NE-50P	
			VA-18	
R 9	1984-	NE-19	NE-16	
R 11	1984-	NE-19P	NE-50P	
			VA-18	
			VA-17P	
R 12	1989-1971	LMP-1	RO-15	
		LMP-1P		
R 12	1972-	LMP-3	VA-7	
		LMP-3P		
R 14	1976-1977	CHR-3	NE-16	
		CHR-3P	NE-50P	
		NE-19		
		NE-19P		
R 14	1978-1979	CHR-3	VA-7	
		CHR-3P		
R 14	1980-	CHR-3	NE-16	
		CHR-3P	NE-50P	
		LMP-4	VA-18	
		LMP-4P1		
		LMP-5		
		LMP-5P1		
R 15	1971-	NE-15I	RO-15	
R 17	1971-	NE-15IP		

AUTOMÓVIL - CAMIONETA

CAR - PICK-UP TRUCKS

MARCA BRAND	MODELO MODEL			
RENAULT	R 16	1965-	NE-3 NE-3P1 NE-3P2	RO-15
	R 18 FUEGO	1970-1980 1970-1980	CHR-3 CHR-3P	NE-16 NE-50P
R 18 FUEGO	1980-1982 1982-	CHR-3 CHR-3P LMP-5 LMP-5P1	VA-18	
R 18	1983-	CHR-3 CHR-3P NE-19 NE-19P1 NE-22P	VA-18	
R 19 ALPINE	1980-1990 1982-	NE-19 NE-19P1	NE-19 NE-19P1	
R 19	1990-	NE-19 NE-19P1 NE-36 NE-36KP1 NE-36P1	NE-19 NE-19P1 NE-36 NE-36KP1 NE-36P1	
R 20 R 20	1975- 1975-	CHR-3 CHR-3P LMP-4 LMP-4P1 NE-22P	VA-17P	
R 21	1985-1989	NE-19 NE-19P1	NE-28 VA-19	
R 21	1990-1991	NE-36 NE-36KP1 NE-36P1	NE-38 NE-36KP1 NE-36P1	
R 21 R 25	1982- 1982-	NE-36 NE-36P1	NE-38 NE-38P1	
COACH MEGANE SAFRANE	1995-1996 1995-1996 1992-1995			
R 25	1983-1988	NE-19 NE-19P1	VA-17P	
R 25	1989-1991	NE-36 NE-36KP1 NE-36P1	VA-17P	
CLIO	1980-1998	NE-36 NE-36KP1 NE-36P1 VA-34 VA-34P	NE-36 NE-36KP1 NE-36P1 VA-34 VA-34P	
ESPACE	1984-1997	NE-19 NE-19P1 NE-36 NE-36KP1 NE-36P1	VA-18	
LAGUNA	1994-	NE-36 NE-36P1 VA-34 VA-34P	NE-38 NE-38P1 VA-34 VA-34P	
LAGUNA	1994-1995	VA-34P1	VA-34P1	
LAGUNA 2ª ed.	1996-	VA-34 VA-34P	NE-50P	
TWINGO	1993-1994	NE-36	NE-36	



MARCA BRAND	MODELO MODEL				
RENAULT			NE-36KP NE-36P NE-36	NE-36KP NE-36P NE-36	
	TWINGO	1995-	NE-36 NE-36KP NE-36P VA-34P1	NE-36 NE-36KP NE-36P VA-34P1	
RENAULT DANGELI	FUEGO	-	CHR-3	NE-16	
	R11	-	NE-22P	NE-50P	
	R18	-			
	NEVADA	-	CHR-3 NE-22P	NE-28	
	R 4	-	NE-3 NE-3P NE-3P2 NE-4 NE-4P NE-4P2	NE-3 NE-3P NE-3P2 NE-4 NE-4P NE-4P2	
	R 6	-	NE-3 NE-3P NE-3P2	NE-3 NE-3P NE-3P2	
	R12	-	CHR-3 NE-22P NE-4 NE-4P NE-4P2	CHR-3 NE-22P NE-4 NE-4P NE-4P2	
	R19	-	NE-36 NE-36KP1 NE-36P1	NE-36 NE-36KP1 NE-36P1	
	R21	-	CHR-3 NE-22P	NE-28 VA-18	
	TRAFFIC	-	CHR-3 NE-22P	NE-16 NE-63 NE-50P	
	RENAULT SAMIEM	B 70.25 B 70.45 B 90.25	1987 1987 1987	CHR-3 CHR-3P LMP-5	VA-7
	MASTER P35 D MASTER T30 D MASTER T35 D	1987 1987 1987	LMP-5P1 NE-22P		
B 70.45 B 90.45 B 90.45 B 90.50	1988-1992 1992- 1988-1992 1988-1992	CHR-3 NE-22P	NE-28		
B 118.150 B 118.25	1992- 1992-				
MASTER T30 D MASTER T35 D MASTER TURBO	1987- 1987- 1987-				
EXPRESS-B-D	1987	NE-19 NE-19P NE-19P1	NE-19 NE-19P NE-19P1		
EXPRESS-B-D SUPERCINCO D	1987-1991 1991	NE-19 NE-19P1	NE-28		
JK 50-68 JK 75-98	- -	BH-1 BH-1P	RO-15 RO-40		
JK 110-115 JP 11 JP 13 JP 13 TU	- - - -	BH-1 BH-1P	RO-41 RO-40 RO-41		



MARCA BRAND	MODELO MODEL			
RENAULT SAVIEM	JP 116	-		
	R 11 CARGO	-1991	NE-10 NE-10P1	VA-10
	R 11 TD	-1992	NE-10 NE-10P1	NE-10 NE-10P1
	RA 14 C. 150	-1994	NE-4	NE-4
	RA 14 C.1100	-1994	NE-4P NE-4P2	NE-4P NE-4P2
	TRAFFIC	-1987	CHR-3 CHR-3P NE-22P	BO-17
	TRAFFIC	1988-	NE-19 NE-19P	NE-20
HOLLIS ROYCE	ALGUNOS-SOME	1991-	YA-200	YA-200
	CLOUD	-1978		
	SHADOW	-1978		
	CLOUD	1981-1997	YA-211	YA-211
	SHADOW	1981-1997		
	MODELOS-MODELS	1976-1977	YA-180 YA-190 YA-201	YA-180 YA-190 YA-201
	SHADOW	1971-1980	YA-211	YA-200
	SPIRIT	1971-1980		YA-201
	SPUR	1971-1980		
	WRAITH	1971-1980		
	SPIRIT	1980-1983	YA-201	YA-201
	SPUR	1980-1983	YA-211	YA-211
	ROVER	2000	1976-1981	LF-RO
2000		1985-	LF-ROP	LF-ROP
2300		1976-1981		
2300		1985-		
2400		1976-1981		
2400		1985-		
2600		1976-1981		
2600		1985-		
3500		1976-1981		
3900		1982-1985	LF-RO	LF-RO
2700		1982-1985	LF-ROP	LF-ROP
2300		1982-1985	NE-11	NE-11
2400		1982-1985	NE-11P	NE-11P
2600		1982-1985		
3500		1982-1985		
2000 SC/TC		1963-1975	LF-9	UN-4
3500		1963-1975		
25		2000-	NE-35P2	NE-35P2
416		1995-1996		
628		1995-1996		
3600 V8 5		1976-	LF-9 LF-RO LF-ROP	UN-11S UN-4
824		1982-1994	NE-52P	NE-52P
825		1982-1994		
ALLEGRO		1973-	LF-RO LF-ROP	UN-11T
ALLEGRO 2		1973-	LF-RO LF-ROP	UN-11T
ALLEGRO 3		1973-	LF-RO	UN-11T

MARCA BRAND	MODELO MODEL				
ROVER			LF-ROF		
			NE-11 NE-11P		
	FX 4S (TAXI)	-	LF-RL LF-RO LF-ROP	IN-4 IN-5	
	MAESTRO	1983-	NE-11	NE-11	
	SERIE 200	1985-1989	NE-11P	NE-11P	
	SERIE 800	1987-1991	NE-11P1 NE-11P2 NE-24 NE-24P NE-24P1	NE-11P1 NE-11P2 NE-24 NE-24P NE-24P1	
	MARINA	-	LF-RL LF-RO LF-ROP NE-1 NE-1P	UN-1T	
	MAXI	1989-	NE-1	UN-FS	
	TRAVELLER	1989-	NE-1P		
	METRO	1989-1993	NE-11	NE-14	
	METRO	1984-1989	NE-11P		
	MINI	1993-1973	UN-FS	UN-FS	
	MINI	1974-1984	LF-RL LF-RO LF-ROP	UN-FS	
	MINI	1985-	NE-11 NE-11P1 NE-11P2	UN-FS	
	MONTIGO	1984-1988	NE-11 NE-11P NE-24 NE-24P	NE-14	
	MONTIGO	1988-1991	NE-11 NE-11P1 NE-11P2 NE-24 NE-24P1	NE-11 NE-11P1 NE-11P2 NE-24 NE-24P1	
	MONTIGO	1992-	NE-25 NE-25P	NE-25 NE-25P	
	PRINCESS	-	NE-11 NE-11P	LF-RO LF-ROP	
	SERIE 100	1991-1993	NE-11 NE-11P1 NE-11P2	NE-11 NE-11P1 NE-11P2	
	SERIE 200	1984-	HOND-10 HOND-10P	HOND-10 HOND-10P	
	SERIE 200	1989-1993	NE-25	NE-25	
	SERIE 400	1989-1993	NE-25P2	NE-25P2	
	SHERPA 185	-	LF-RL	UN-1FS	
	SHERPA 230	-	LF-RO	UN-1T	
	SHERPA 255	-	LF-ROP		
	SAAB	93	1988-	SAA-1P1	SAA-1P1
		900	1993-		
		9000	1986-		
95		-	SA-10	SAA-AC	
96		-	SAA-AC SAA-ACP	SAA-ACP	
90		1974-1977	SAA-2P	SAA-2P	



AUTOMÓVIL - CAMIONETA

CAR - PICK-UP TRUCKS

MARCA BRAND	MODELO MODEL			
DAEW	900	1974-1977		
	900	1978-1993	SAA-AC SAA-ACP	SAA-AC SAA-ACP
SEAT	124	1976-	FI-9I	IMS-3
			FI-9IP	IMS-3P IMS-5 IMS-5P
	127	1977-	FI-9I	IMS-3
	131	1977-1978	FI-9IP	IMS-3P
			IMS-7	IMS-5
			IMS-7P	IMS-5P
	131	1978-	CL-7P	CL-7P
			FI-20	FI-30
			FI-20P3	FI-30P
			FI-20	FI-30P
	132	1973-	AF-7I	IMS-3
			AF-7IP	IMS-3P
			FI-8I	IMS-5
			FI-8IP	IMS-5P
FO-7B				
FO-7BP				
CORDOBA	1993-1995	AU-AH	AU-AH	
EMELBA	1993-	AU-AHP	AU-AHP	
IBIZA	1993-1995	SE-AHP	SE-AHP	
POKER	1993-	VO-2	VO-2	
TOLEDO	1991-1995	VO-2KP	VO-2KP	
		VO-2P	VO-2P	
EMELBA	1984-1987	CL-6	CL-6	
GREDOS (GRE)	-	CL-6P	CL-6P	
IBIZA	1984-1987			
MALAGA	1985-1990			
POKER	1984-1987			
RONDA	1985-			
EMELBA	1988-1992	AU-HV	AU-HV	
IBIZA	1988-1992	CL-6P	CL-6P	
POKER	1988-1992	VO-2KP	VO-2KP	
		VO-HV	VO-HV	
FURA	1972-1982	CL-7P	IMS-3	
		FI-30	IMS-3P	
		FI-30P	IMS-5	
		FI-8I	IMS-5P	
		IMS-7		
		IMS-7P		
MARBELLA	1987-1992	CL-6	IMS-3	
TERRA	-	CL-6P	IMS-3P IMS-5 IMS-5P	
MARBELLA	1993-1997	AU-AH	AU-AH	
		AU-AHP	AU-AHP	
		CL-6	CL-6	
		CL-6P	CL-6P	
		SE-AHP	SE-AHP	
		VO-2	VO-2	
	VO-2KP	VO-2KP		
	VO-2P	VO-2P		
PANDA	1980-1986	FI-8I	IMS-3	



MARCA BRAND	MODELO MODEL			
SEAT			FI-9IP	IMS-3P
			FI-9I	IMS-5
			FI-9IP	IMS-5P
	RITMO	-	CL-7P	CL-7P
	RONDA	1982-1984	FI-30	FI-30
			FI-30P	FI-30P
TRANS	-	CL-6	IMS-3	
		CL-6P	IMS-3P	
		FI-9I	IMS-5 IMS-5P	
SKODA	100	1982-1984	SKO-1	
	105	1982-1984	SKO-1P	
	110	1982-1984	SKO-2	
	120	1982-1984		
	110	1985-	SKO-1	
	120	1985-	SKO-1P	
	130	1985-		
	135	1985-		
	ESTELLE	1985-		
	GARD LUXE	1985-		
	RAPIDE	1985-		
	FAVORIT	1987-	SKO-3I	SKO-3I
	FORMAN	1987-	SKO-3IP	SKO-3IP
	SILVER	1982-		
FELICIA	1985-	SKO-5P	SKO-5P	
PICK-UP	1985-			
MOXLOS - MOXLS	1984-1981	SKO-8	SKO-4	
SANGYONG	KORANDO	2000-	HY-5	HY-5
			HY-5P	HY-5P
MUSSO	1985-	HY-3P2	HY-3P2	
STERLING	SERIE 800	-	NE-11	
			NE-11P	
			NE-24	
			NE-24P	
STEYR PUCH	10 S21	-1984	NE-14D	
	10 S27	-1984		
	26 S21	-1984		
	32 S21	-1984		
	238	-1979	ME-H2	ME-H2
	248	-1979	ME-H2P	ME-H2P
	268	-1979		
	308	1979-		
	238	1979-	ME-HF	ME-HF
	248	1979-	ME-HFP	ME-HFP
	288	1979-	ME-HM	ME-HM
			ME-HMP	ME-HMP
PANDA 4x4	1983-1985	AF-7I	IMS-3	
		AF-7IP	IMS-3P	
		FI-9I	IMS-5	
		FI-9IP	IMS-5P	
PANDA 4x4	1986-1988	FI-1	IMS-3	
		FI-11	IMS-3P	
		FI-11KP	IMS-5	
		FI-11P	IMS-5P	
		FI-1P		
PANDA 4x4	1989-	FI-1	FI-1	
		FI-11	FI-11	
		FI-11KP	FI-11KP	
		FI-11P	FI-11P	

MARCA BRAND	MODELO MODEL			
STEYR-PUCH			FI-1P	FI-1P
SUBARU	ALCYONE	1980-	DAT-4	DAT-4
	E11 VAN	1980-	DAT-6D	DAT-6D
	E12 VAN	1980-	DAT-6DP	DAT-6DP
	ES VAN	1980-	DAT-6DP1	DAT-6DP1
	EJ VAN	1980-	DAT-6P	DAT-6P
	HUNTER	1980-	DAT-6P1	DAT-6P1
	JUSTY (EU)	1980-1990		
	L 1.3	1980-		
	L 1.6	1980-		
	L 1.8	1980-		
	LEGACY 4WD	1980-1990		
	LEONE	1980-		
	M 70	1980-		
	M 90	1980-		
	SAMBAI VAN	1980-		
	XT	1980-		
	E18 DOMINGO	1984-1985	DAT-11D	DAT-8I
	JUSTY	1984-1985	DAT-11DP	DAT-8IP
	L 1.3	1984-1985	WAS-2P	DAT-8P1
	L 1.6	1984-1985		
	L 1.8	1984-1985		
	M 70	1984-1985		
	M 90	1984-1985		
	RX	1984-1985		
	HATCHBACK	1985-	DAT-4	DAT-4
	JUSTY XT	1985-1990	DAT-6P	DAT-6P
	LEGACY	1985-1990	DAT-6P1	DAT-6P1
	LOYALE	1985-	DAT-7	DAT-7
		DAT-7P	DAT-7P	
IMPREZA	1985-	DAT-4	DAT-4	
		DAT-6P1	DAT-6P1	
JUSTY	1991-1996	DAT-4	DAT-7	
		DAT-6P1		
LEONE	1973-1982	DAT-11D	DAT-1D	
RX	1973-1982	DAT-11DP	DAT-1DP	
SEDAN	1973-1982	WAS-2P	DAT-1I	
TIGRE	1973-1982		DAT-1IP	
			DAT-2D	
			DAT-2DP	
			DAT-2I	
			DAT-2IP	
LEONE	1983-1984	DAT-11D	DAT-2I	
RX	1983-1984	DAT-11DP	DAT-2IP	
SEDAN	1983-1984	WAS-2P		
TIGRE	1983-1984			
MODELOS - MODELS	1970-1972	DAT-1I	DAT-1I	
		DAT-1IP	DAT-1IP	
MODELOS - MODELS	2000-	DAT-15	DAT-15	
SOLARIS	54	-1991	54-4	ZA-1
	125	-1991		ZA-1P
SUBARU	1.8	-	LF-SL	LF-SL
	1.3	-	LF-SLP	LF-SLP
	1.6	-		
SUZUKI	ALTO	1976-1984	TOYO-14	TOYO-14
	CERVO	1976-1984	TOYO-14P	TOYO-14P
	CULTUS	1976-1984		
	ESTEEM	1976-1984		
	FRONTE	1976-1984		



MARCA BRAND	MODELO MODEL			
SUZUKI	GOLD FINGER	1976-1984		
	JIMMY	1976-1984		
	S-CARRY	1980-		
	SAMURAI	1976-1984		
	SAMURAI	1980-		
	SJ 30	1976-1984		
	SJ 310	1976-1984		
	SJ 410	1976-1984		
	SJ 413	1976-1984		
	VITARA	1980-		
	ACTO	1980-1995	SUZU-7	SUZU-7
	CERVO	1980-	SUZU-7P	SUZU-7P
	CULTUS	1980-		
	ALTO	1980-	SUZU-8	SUZU-8
	CARRY VAN	1980-1991	SUZU-8P	SUZU-8P
	EVERY VAN	1980-1991		
	SWIFT	1980-1991		
	VITARA	1980-1991		
	VITARA	1991-		
	BALENO	1995-	SUZU-10	SUZU-10
	ESCUDO	1980-1991	SUZU-10P	SUZU-10P
	SIDEKICK	1980-1991		
	SWIFT	1991-1996		
	CULTUS	1984-1991	MIT-2I	MIT-2I
	SAMURAI	1984-1991	TOYO-14	TOYO-14
			TOYO-14P	TOYO-14P
	LJ 50	1976-	TOYO-14	TOYO-14
	LJ 80	1976-	TOYO-14P	TOYO-14P
		TOYO-K1	TOYO-K1	
		TOYO-K1P	TOYO-K1P	
SJ 410	1985-1988	IMS-7	IMS-10	
SJ 413	1985-1988	IMS-7P		
SJ 410	1989-1991	IMS-7	IMS-11P	
SJ 413	1989-1991	IMS-7P	SUZU-9P	
VALIOT SMC	154	1975-	LMP-3	LMP-3
	1518	1975-	LMP-3P	LMP-3P
	ALPINE	1975-		
	HORIZON	1980-1983		
	MINX	1980-1983		
	OMNI	1980-1983		
	RAPHER	1975-		
	104 GT	1975-	CHR-3	CHR-3
	100	1975-	NE-22P2	NE-22P2
	1307	1975-		
	1300	1975-		
	1300	1975-		
	HORIZON	1984-		
	MINX	1984-		
	MURENA	1980-		
	OMNI	1984-		
	1000	1984-1973	NE-3	RO-3
	1005	1984-1973	NE-3P1	
1006	1984-1973	NE-3P2		
1007	1984-1973			
1100	1984-1973			
1301	1974-1973			
1541	1974-			
1100	1974-	CHR-3	RO-3	
		NE-22P2		



AUTOMÓVIL - CAMIONETA

CAR - PICK-UP TRUCKS

MARCA BRAND	MODELO MODEL				
DAEWOO SIMCA	BAGHEERA	1975-	NE-3 NE-3P1 NE-3P2		
	HORIZON	1977-1979	CHR-3	CHR-3	
	HORIZON GL	1977-1979	NE-22P2	LMP-3	
	MINI	1977-1979		LMP-3P	
	OMNI	1977-1979		NE-22P2	
	RANCH	1977-	CHR-3 NE-22P2		
	RAPIER	1988-	CHR-3	CHR-3	
	SAMBA	1981-1983	NE-22P2	NE-22P2	
	SOLARA	1988-	NE-33P1	NE-33P1	
	TAGORA	1988-			
	SAMBA	1988-	CHR-3 NE-22P2 NE-33P1	CHR-3 NE-22P2 VA-6 VA-6P	
	TATA	INDICA	2000-	TAT-1D TAT-1DP	TAT-1D TAT-1DP
	TOYOTA	3 DR LIFT B.	1988-1989	TOYO-12	TOYO-12
4 RUNNER		1988-1989	TOYO-12P1	TOYO-12P1	
CELICA		1988-1989	TOYO-8	TOYO-8	
COROLLA		1988-1989	TOYO-8P	TOYO-8P	
MR2		1989-1990			
SUPRA EFI SR		1988-1989			
TERCEL		1989-			
4 RUNNER		1979-1986	TOYO-12	TOYO-12	
L-CRUISER		1979-1986	TOYO-12P1 TOYO-2 TOYO-K1 TOYO-K1P	TOYO-12P1 TOYO-2 TOYO-K1 TOYO-K1P	
4 RUNNER		1986-1988	TOYO-16	TOYO-16	
CAMRY		1986-1991	TOYO-16P	TOYO-16P	
DYNA		1988-	TOYO-16P1	TOYO-16P1	
L-CRUISER		1988-1989	TOYO-5	TOYO-5	
LITEACE		1988-	TOYO-5P	TOYO-5P	
RUNNER		1988-1989	TOYO-5P1	TOYO-5P1	
STARLET		1988-1997			
VX TURBO		1988-1989			
4 RUNNER		1989-1991	TOYO-26D	TOYO-26D	
CARINA		1989-1994	TOYO-9	TOYO-9	
CELICA COUPE		1991-1996	TOYO-9P	TOYO-9P	
COROLLA		1989-1991	TOYO-9P1	TOYO-9P1	
CRESSIDA		1988-			
HILUX VAN		1988-			
HILUX 4x4		1995-			
HILUX VAN		1988-			
L-CRUISER		1988-1991			
MR2		1991-1997			
RUNNER		1988-1991			
4 RUNNER		1991-	TOYO-15	TOYO-15	
CAMRY		1991-	TOYO-15P	TOYO-15P	
CARINA S.W.		1995-			
CELICA		1995-			
COROLLA		1991-1996			
SAVI		1995-			
RUNNER		1991-			
ARROW		1978-1972	TOYO-4	TOYO-4	
CELICA SUPRA		1982-1985	TOYO-8P	TOYO-8P	

MARCA BRAND	MODELO MODEL			
TOYOTA	CROWN	1978-1972		
	CAMRY	1984-1989	TOYO-13 TOYO-13P1 TOYO-28P	TOYO-13 TOYO-13P1 TOYO-28P
	CAMRY GL	1984-	TOYO-3	TOYO-3
	CAMRY GLI	1984-	TOYO-3P	TOYO-3P
	CARINA	1983-1985	TOYO-8	TOYO-8
	COROLLA	1975-1982	TOYO-8P	TOYO-8P
	COROLLA 4DR	1986-1986		
	CORONA	1983-1985		
	CORSA	1983-1985		
	CRESSIDA	1983-1985		
	CRESTA	1983-1985		
	CROWN	1983-1985		
	MARK II	1983-1985		
	MR2	1983-1985		
	SPRINTER	1983-1985		
	TERCEL	1983-1985		
	CARINA	1972-1982	TOYO-14	TOYO-14
	CELICA	1972-1982	TOYO-14P	TOYO-14P
	COROLLA	1972-1974	TOYO-K1	TOYO-K1
	CORONA	1972-1974	TOYO-K1P	TOYO-K1P
	CROWN	1972-1982		
	HILUX	1972-1979		
	HILUX	1972-1979		
	MARK II	1972-1982		
	PUBLICA	1972-1974		
	STARLET	1972-1982		
	CARINA	1985-1986	TOYO-3	TOYO-3
	CORONA	1985-1986	TOYO-3P	TOYO-3P
	SPRINTER	1985-1986		
	TERCEL 4WD	1985-1986		
	CARINA	1984-	TOYO-19P	TOYO-19P
	CELICA	1983-1985	TOYO-12 TOYO-12D TOYO-12P1 TOYO-22 TOYO-22D TOYO-3 TOYO-3P TOYO-8 TOYO-8P TOYO-K1 TOYO-K1P	TOYO-12 TOYO-12D TOYO-12P1 TOYO-22 TOYO-22D TOYO-3 TOYO-3P TOYO-8 TOYO-8P TOYO-K1 TOYO-K1P
	CELICA	1986-1988	TOYO-18	TOYO-18
	COROLLA ST	1988-1989	TOYO-18P	TOYO-18P
	TERCEL	1987-1988	TOYO-11 TOYO-11P	TOYO-11 TOYO-11P
	CELICA	1988-1995	TOYO-18 TOYO-18P TOYO-18P1 TOYO-11 TOYO-11P TOYO-11P1 TOYO-28D TOYO-8 TOYO-8P TOYO-9P1 TOYO-9P1	TOYO-18 TOYO-18P TOYO-18P1 TOYO-11 TOYO-11P TOYO-11P1 TOYO-28D TOYO-8 TOYO-8P TOYO-9P1 TOYO-9P1
	CELICA 4WD	1988-1991	TOYO-18	TOYO-18

MARCA BRAND	MODELO MODEL			
TOYOTA	MR2	1988-1991	TOYO-18P	TOYO-18P
	PREVIA	1993-1997	TOYO-18P1	TOYO-18P1
			TOYO-11	TOYO-11
			TOYO-11P	TOYO-11P
			TOYO-11P1	TOYO-11P1
	CELICA LIFE	1991-1996	TOYO-18	TOYO-18
			TOYO-18P1	TOYO-18P1
	COROLLA	1983-1987	TOYO-12	TOYO-12
	TERCEL	1985-1987	TOYO-12P1	TOYO-12P1
			TOYO-22	TOYO-22
			TOYO-22S	TOYO-22S
			TOYO-K1	TOYO-K1
			TOYO-K1P	TOYO-K1P
	COROLLA S	1972-1976	TOYO-2	TOYO-2
			TOYO-4	TOYO-4
			TOYO-4P	TOYO-4P
	COROLLA DX	1985-1986	TOYO-23	TOYO-23
	CRESSIDA	1977-1978	TOYO-23P	TOYO-23P
	CRESTA	1977-1978		
	COROLLA GT	1985-1986	TOYO-4	TOYO-4
			TOYO-4P	TOYO-4P
			TOYO-14	TOYO-14
			TOYO-14P	TOYO-14P
	COROLLA SM	1973-1978	TOYO-4	TOYO-4
			TOYO-4P	TOYO-4P
			TOYO-K1	TOYO-K1
			TOYO-K1P	TOYO-K1P
	COROLLA SW	1993-1996	TOYO-17	TOYO-17
			TOYO-17P	TOYO-17P
	CRESSIDA	1984-1987	TOYO-28P	TOYO-28P
CRESSIDA	1985-1987	TOYO-13	TOYO-13	
		TOYO-13P1	TOYO-13P1	
FX 16	1987-1988	TOYO-K1	TOYO-K1	
STARLET	1984-1990	TOYO-K1P	TOYO-K1P	
HDJ 80	1991-	TOYO-18P	TOYO-18P	
L-CRUISER	1991-			
PASO	1991-1997	TOYO-18	TOYO-18	
		TOYO-18P	TOYO-18P	
		TOYO-18P1	TOYO-18P1	
VARIOS - SEVERAL	1989	TOYO-25	TOYO-25	
VARIOS - SEVERAL	1976-	TOYO-29	TOYO-29	
TRABANT	TODOS - ALL	-	D08-1	D08-1
			D08-10	D08-10
			D08-2	D08-3
			D08-20	D08-20
			D08-3	D08-3
			D08-30	D08-30
TRIUMPH	ACCLAIM	1981-	HOND-1	HOND-1
			HOND-1P	HOND-1P
			HOND-2	HOND-2
			HOND-3P	HOND-3P
	DOLOMITE	1973-	UN-NH	UN-FS
	TOLEDO	1973-	UN-NHP	
	GTX MK3	-	FO-FB	UN-NH
			FO-FBP	UN-NHP
			UN-NH	
			UN-NHP	
		WAS-3P		
GTX MK3	1972-	FO-FB	UN-NH	



MARCA BRAND	MODELO MODEL			
TRIUMPH	SPITFIRE	1972-1974	FO-FBP	UN-NHP
	SPITFIRE MK4	1972-	WAS-3P	
	MODELOS - MODELS	1968	UN-FS	UN-44
				UN-FF
	SPITFIRE	1974-1978	LF-WB	UN-NH
			LF-WBP	UN-NHP
	SPITFIRE	1979-	UN-NH	
			UN-NHP	
	TR6 PJ SPID.	1969-1977	FO-FB	UN-FT
			FO-FBP	UN-NH
WAS-3P			UN-NHP	
TR7 COUPE	1975-1981	UN-NH	UN-FT	
TR7 SPIDER	1975-1981	UN-NHP	UN-NH	
			UN-NHP	
VAZ	452	-	BH-1	IMS-3
	460	-	BH-1P	IMS-3P
	469 DIESEL	-	VOL-2	IMS-5
			VOL-3	IMS-5P
				VOL-2
				VOL-3
	FURGON 48LM	-	VOL-2	IMS-3
				IMS-3P
				IMS-5
				IMS-5P
ROAD MASTER	-	BS-4		
WEDGELL	ASTRA	1975-1979	OP-J	OP-J
	CHEVRETTE	1975-1979	OP-JP	OP-JP
	ASTRA	1984-1985	OP-D	OP-D
	ASTRAMAX	1984-	OP-DKP	OP-DKP
	BELMONT	1984-	OP-OP	OP-OP
	NOVA	1984-	OP-S	OP-S
	ROYALE	1984-	OP-SKP	OP-SKP
			OP-SP	OP-SP
	CARLTON	1979-1981	OP-B	OP-B
	VICEROY	1979-1989	OP-8P	OP-8P
OP-T			OP-T	
OP-TP			OP-TP	
CARLTON	1982-	OP-WHP	OP-WHP	
CAVALIER	1982-	OP-WYP	OP-WYP	
SENATOR	1982-			
CAVALIER	1975-1981	OP-AB	OP-AB	
		OP-ABP	OP-ABP	
		OP-SA	OP-SA	
		OP-BAP	OP-BAP	
		OP-J	OP-J	
		OP-JP	OP-JP	
FIRENZA	-	LF-RO	LF-6	
		LF-ROP		
VOLCA	GAZ 124	-	VOL-1	VOL-1
			VOL-1P	VOL-1P
	GAZ 129	-	NE-3	VOL-1
			NE-3P	VOL-1P
			NE-3P2	VOL-2
				VOL-20
				VOL-3
	GAZ 3118	-	NE-3	VOL-1
			NE-3P	VOL-1P
			NE-3P2	VOL-4
			VOL-5P	



AUTOMÓVIL - CAMIONETA

CAR - PICK-UP TRUCKS

MARCA BRAND	MODELO MODEL			
VOLKSWAGEN	411	1976-1977	VO-K	
	412	1976-1977		
	1100	1976-1977		
	1000	1976-1977		
	BRASILIA	1976-1977		
	411	1973-1974	VO-VB	VO-VB
	412	1973-1974	VO-VBP	VO-VBP
	BRASILIA	1973-1974		
	CABRIOLET	1975-1981		
	DERBY AMAZON	1977-1980		
FAMILIAR	1977-1980			
GOLF	1977-1980			
IGALA	1973-1974			
PASSAT	1973-			
PASSAT	1977-1980			
POLO	1975-1976			
POLO	1977-1980			
SCIROCCO	1975-1981			
1300 CABRIO	1976-	HU-SU	VO-M	
			VO-MP	
ALL STAR	1991-	VO-Z	VO-Z	
CALIFORNIA	1991-	VO-ZKP	VO-ZKP	
CLUB VAN	1991-	VO-ZP	VO-ZP	
POLO	1991-1995			
SINCR0	1991-			
TRANSPORTER	1991-1995			
BEETLE	1976-1978	VO-M	VO-M	
EL VOLKSWAGE	1976-1978	VO-MP	VO-MP	
ESCARABAJO	1976-1978			
FUSCA	1976-1978			
CADDDY	-	AU-1	AU-1	
POLO	1981-1982	AU-IV	AU-IV	
		AU-HVP	AU-HVP	
		VO-ZKP	VO-ZKP	
		VO-IV	VO-IV	
		VO-HVP	VO-HVP	
CORRADO	1988-	AU-AN	AU-AN	
GOLF	1988-1990	AU-ANP	AU-ANP	
GOLF	1991-1995	HU-AN	HU-AN	
JETTA ATLAN.	1988-	VO-Z	VO-Z	
PASSAT	1988-1995	VO-ZKP	VO-ZKP	
VENTO	1992-1995	VO-ZP	VO-ZP	
DERBY AMAZON	1981-1982	AU-1	AU-1	
DERBY AMAZON	1985-1987	AU-IV	AU-IV	
GOLF	1981-1982	AU-HVP	AU-HVP	
GOLF	1985-1987	VO-ZKP	VO-ZKP	
GOLF CABRIO	1981-1984	VO-IV	VO-IV	
JETTA ATLAN.	1981-1984	VO-HVP	VO-HVP	
JETTA ATLAN.	1985-1987	VO-VB	VO-VB	
PASSAT	1981-1984	VO-VBP	VO-VBP	
PASSAT	1985-1987			
POLO	1985-1991			
SANTANA	1981-1982			
SCIROCCO	1981-1982			
SCIROCCO	1985-1987			
GOLF	1975-1977	VO-VB	HU-SU	
		VO-VBP	VO-VB	
			VO-VBP	
GOLF	1987-1988	VO-Z	VO-Z	

MARCA BRAND	MODELO MODEL			
VOLKSWAGEN			VO-ZKP	VO-ZKP
			VO-ZP	VO-ZP
			VO-ANP	VO-ANP
	K 30	1976-1977	FO-PN	FO-PN
	K 30 LS	1976-1977	VO-VB	VO-VB
			VO-VBP	VO-VBP
	LT 200	1976-1979	VO-B	VO-B
	LT 21	1976-1979	VO-EP	VO-EP
	PASSAT FAM.	1973-1976		
	TL 21	1976-1979		
TL 45	1976-1979			
TL 50	1976-1979			
MODELOS - MODELS	1966-1969	FO-D	VO-L	
		VO-L		
TARO NISSAN	1989-	TOYO-280	TOYO-280	
		TOYO-9	TOYO-9	
		TOYO-9P	TOYO-9P	
		TOYO-9P1	TOYO-9P1	
TL 21	1989-	VO-N	VO-N	
TL 25	1989-	VO-NP	VO-NP	
TL 45	1989-			
TL 50	1989-			
TRANSPORTER	1989-1991			
VAGON	1989-			
VOLKSWAGEN (ARGEN.)	1500	-		CHR-8
				CHR-8P
	GACEL	-	VO-8KP	VO-8KP
			VO-FHP1	VO-FHP1
	GOL	-1995	VO-8KP	VO-8KP
			VO-FHP1	VO-FHP1
			VO-VB	VO-VB
			VO-VBP	VO-VBP
	GOL	1996-	VO-ZDP	VO-ZDP
	GOL	1997-	VO-EP	VO-EP
KOMBI	-	VO-B	VO-B	
		VO-EP	VO-EP	
POINTER	-	VO-SP	VO-SP	
SAVERIO	-	VO-ZKP	VO-ZKP	
		VO-IV	VO-IV	
		VO-HVP	VO-HVP	
		VO-VB	VO-VB	
		VO-VBP	VO-VBP	
SENDA	-	VO-ZKP	VO-ZKP	
		VO-IV	VO-IV	
		VO-HVP	VO-HVP	
VOLKSWAGEN (BRASIL)	FOX	1975-1976	VO-VB	VO-VB
	FOX	1977-1980	VO-VBP	VO-VBP
	GOL	1975-1976		
	GOL	1977-1980		
	PARATI	1973-		
	PARATI	1977-1980		
	QUANTUM	1973-		
	QUANTUM	1977-1980		
	FOX	1981-1982	AU-1	AS-1
	GOL	1981-1982	AU-IV	AU-IV
		AU-HVP	AU-HVP	
		VO-ZKP	VO-ZKP	
		VO-IV	VO-IV	
		VO-HVP	VO-HVP	

MARCA BRAND	MODELO MODEL			
VOLKSWAGEN (BRASIL)	FOX	1985-1991	AU-1	AU-1
	GOL	1985-1991	AU-HV	AU-HV
	PARATI	1981-1984	AU-HVP	AU-HVP
	PARATI	1985-1987	VO-3CP	VO-3CP
	QUANTUM	1981-1984	VO-HV	VO-HV
	QUANTUM	1985-1987	VO-HVP	VO-HVP
	SANTANA	1981-1982	VO-VB	VO-VB
			VO-VBP	VO-VBP
	FOX	1991-	VO-2	VO-2
	GOL	1991-	VO-2CP	VO-2CP
			VO-2P	VO-2P
	PARATI	1988-	AU-AN	AU-AN
	QUANTUM	1988-	AU-ANP	AU-ANP
			HU-AN	HU-AN
			VO-2	VO-2
		VO-2CP	VO-2CP	
		VO-2P	VO-2P	
VARIOS - SEVERAL	1990-	VO-2DP1	VO-2DP1	
		VO-3P1	VO-3P1	
		VO-8P1	VO-8P1	
VOLKSWAGEN (CHINA)	SHANGHAI	1973-	VO-VB	VO-VB
	SHANGHAI	1977-1988	VO-VBP	VO-VBP
	SHANGHAI	1981-1984	AU-1	AU-1
	SHANGHAI	1985-1987	AU-HV	AU-HV
			AU-HVP	AU-HVP
			VO-3CP	VO-3CP
			VO-HV	VO-HV
			VO-HVP	VO-HVP
			VO-VB	VO-VB
			VO-VBP	VO-VBP
	SHANGHAI	1988-	AU-AN	AU-AN
			AU-ANP	AU-ANP
			HU-AN	HU-AN
			VO-2	VO-2
			VO-2CP	VO-2CP
		VO-2P	VO-2P	
VOLKSWAGEN (MEXICO)	ESCARABAJO	-	VO-M	VO-M
			VO-MP	VO-MP
VOLVO	66 GL	1972-1976		FO-5
	66 GL	1972-1976		
	66 L	1972-1976		
	66 MARATHON	1972-1976		
	66 SL	1972-1976		
	142	1968-1972	NE-13	UN-FR
	144	1968-1972		
	145	1968-1972		
	164	1968-1972		
	142	1973-1976	NE-18	NE-8
	144	1973-1976	NE-18P	NE-8P
	145	1973-1976		WAS-1
	164	1973-1976		
	240	1973-1976		
	242	1973-1976		
	244	1973-1976		
	264	1973-1976		
	240	1977-1978	NE-12	NE-8
	242	1977-1978	NE-12P	NE-8P
	244	1977-1978		
245	1977-1978			

MARCA BRAND	MODELO MODEL			
VOLVO	240	1977-1978		
	242	1977-1978		
	244	1977-1978		
	265	1977-1978		
	240	1978-1984	NE-12	NE-12
	242	1978-1983	NE-12P	NE-12P
	244	1978-1983		
	245	1978-1983		
	262	1978-1983		
	264	1978-1983		
	265	1978-1983		
	240	1984-1985	NE-12	NE-12
	240	1986-1991	NE-12P	NE-12P
	260	1984-1987	NE-18	NE-18
	280	1986-1991	NE-18P	NE-18P
	340	1926-1984	HU-DF	AKS-1
	342	1926-1984	HU-DFP	
	345	1926-1984	HU-DFP1	
	364	1926-1984		
	340	1985-1986	HU-DF	HU-DF
	360	1985-1986	HU-DFP	HU-DFP
			HU-DFP1	HU-DFP1
	440	1987-	HU-DHP	HU-DHP
	460	1987-	HU-DNP	HU-DNP
	480	1987-		
	260	1991-	NE-40	NE-40
	262	1991-	NE-40P	NE-40P
	264	1991-	NE-41P	NE-41P
	265	1991-		
	960	1991-1996		
850	1991-1996	NE-40	NE-40	
		NE-40P	NE-40P	
AMAZON 140	-1973	NE-13	UN-4	
		NE-16	UN-1P	
			UN-FS	
FR 12	1997-	HU-DHP	HU-DHP	
PV AMAZON	-	AS-11	HU-1	
		AS-24		
WAIBUHO	MOXLOS - MOXLS	-	DOB-1	DOB-1
			DOB-10	DOB-10
			DOB-2	DOB-2
			DOB-20	DOB-20
			DOB-3	DOB-3
			DOB-30	DOB-30
YUGO-ZASTAVA	101	1971-1982	FO-FR	IMS-3
	311	1971-1982	FO-FRP	IMS-3P
	411	1971-1982		IMS-5
	413	1971-1982		IMS-5P
	511	1971-1982		
	513	1971-1982		
	KORAL	1987-	FI-61	FI-30
	YUGO 45	1987-	FI-61P3	FI-30P
	YUGO 55	1987-		FI-30P5
	YUGO 65	1987-		
YUGO 45	1982-1984	FI-61	FI-61	
YUGO 55	1982-1984	FI-61P3	FI-61P3	
		FO-E/TC	IMS-3	
		FO-L/TCP	IMS-3P	

AUTOMÓVIL - CAMIONETA

CAR - PICK-UP TRUCKS

MARCA BRAND	MODELO MODEL			
YUGO-ZASTAVA			FD-1B FD-1BP	BMS-1 BMS-1P S3P-1
	YUGO 45	1985-1986	FD-61	YU-1D
	YUGO 55	1985-1986	FD-61P3	
	YUGO 65	1985-1986		
	YUGO 45	1986-1987	FD-61	BMS-3
	YUGO 55	1986-1987	FD-61P3	BMS-3P
	YUGO 65	1986-1987		BMS-5 BMS-5P
JAZ	966	-	NE-3	VOL-3
	968 A	-	NE-3P	
	968 M	-	NE-3P1	
			NE-3P2	
	TAVRIA	-	NE-3	AF-15
			NE-3P	AF-15P
			NE-3P1	
NE-3P2				

CAMIÓN



KAMIONA
TRUCKS
CAMION
LKW









THE KEY TO EXCELLENCE
GLOBALLY UNLOCKING MILLIONS OF DOORS DAILY



CAMIÓN

KAMIOIA • TRUCKS • CAMION • LKW

MARCA BRAND	MODELO MODEL			
ASTRA	BM 64.26	-	AF-7I	IMS-3
	BM 64.38	-	AF-7P	IMS-3P
	BM 64.36	-	AF-8D	IMS-3
	BM 66.38	-	AF-8DP	IMS-3P
	BM 66.36	-	AF-8I	
	BM 281	-	AF-8P	
	BM 386	-	AF-9D	
				AF-9DP
			AF-9I	
			AF-9P	
BEDFORD	CF	-1988	LF-8	UM-1FS
			LF-8D	
			LF-8DP	
			NE-10	
			NE-11P	
	CF	1988	NE-10	UM-1T
	CF 2.258 D	1988	NE-11P	WAS-4
	CF 2.268 D	1988		WAS-4P
	TL 500	-	NE-1	LF-6
	TL 800	-	NE-10	
TL 1268	-	NE-11P		
TM	-	NE-1P		
BROCKWAY	VARIOS - SEVERAL	1966	BS-4D	BS-4D
			YA-8D	YA-8D
			YA-8I	YA-8I
DAF	2800	-	CHR-3	FO-0A
	3000	-	CHR-3P	
	FA 2100 DT	-		
	FA 2105	-		
	FA 2505	-		
	FA 2805	-		
	FA 3005	-		
	FAS 3005	-		
	FAT 3026	-		
	FAT 3026	-		
	FT 2505	-		
	FT 2805	-		
	FT 3005	-		
	FTT 2026	-		
	FTT 3026	-		
	2800 T. INL	-1984	NE-3	FO-0A
	FA 1300	1988-1992	NE-3P	
	FA 1300 T	1988-1992	NE-3P1	
	FA 2100	1988-1992	NE-3P2	
	FA 2500	1988-1992		
	F 1100	1985-1991	CHR-3	FO-0A
	F 1300	1985-1991	NE-22P2	
	F 1700	1985-1991		
	F 1000	1985-1991		
	F 2100	1985-1991		
	F 2500	1985-1991		
	F 3026	1985-1991		
	FA 1100 DT	-	DAY-1	RO-4D

MARCA BRAND	MODELO MODEL			
DAF	FA 1300 DNT	-	DAY-1P	RO-4I
	FA 1300 DT	-		
	FA 2100	1982-1994		
	FA 2500	1982-1994		
	FA 2500	-	CHR-3	FO-0A
			CHR-3P	
			NE-3	
			NE-3P	
			NE-3P1	
			NE-3P2	
	F-FA-V-600	1985-1991	NE-11	FO-0A
	F-FA-V-800	1985-1991	NE-11P	
	F-FA-V-1000	1985-1991		
	FT 25.220R	-	CHR-3	VO-VB
	FT 85.261W	-	NE-22P	VO-VRP
FT 3300	-			
SERIE FT	1991	CHR-3	VO-VB	
		CHR-3P	VO-VRP	
V 400	1991	NE-11	NE-11	
V 600	1991	NE-11P	NE-11P	
DIAMOND REG				
VARIOS - SEVERAL 1968				
FAT IVECO				
	38.8	-1991	FI-11	FI-11
	35.10	-1991	FI-11KP	FI-11KP
	35.8	-1991	FI-11P	FI-11P
	40.10	-1991	FI-1P	FI-1P
	45.10	-1991		
	38.8	1992	FI-12	FI-11
	35.10	1992	FI-12P1	FI-11KP
	35.12	1992		FI-11P
	35.8	1992		
	40.10	1992		
	40 NC 25	-	AF-8D	AF-8D
	40.8 F 8	-	AF-9DP	AF-8I
			AF-9I	AF-4D
			AF-9P	AF-6I
	58 NC	-	AF-9D	IMS-3
	55	-	AF-9DP	IMS-3P
	55 NC	-	AF-9I	IMS-5
	88 NC	1979	AF-9P	IMS-5P
			FEM-1D	
			FEM-1I	
	58.10 F 10	1979	LF-8D	IMS-3
	55.8 F 8	1979	LF-8DP	IMS-3P
	68.10 F 10	1979	SIP-1	IMS-5
	65.10 F 10	1979		IMS-5P
	70.10 F 10	1979		
	70.10 F 10	1979		
	70.12 F 12	1979		
	70.14 F 14	1979		
	88.12 F 12	1979		
	95.14 F 14	1979		
	100	1979		
	58.9	-1994	FI-6I	IMS-3

MARCA BRAND	MODELO MODEL			
FIAT VEICO	68.11	-1994	FI-60P1	BMS-3P
	65.12	-1994	FI-61	BMS-5
	75.14	-1994	FI-60P	BMS-5P
	88.14	-1994		
	95.14	-1994		
	109.14	-1994		
	118.17	-1994		
	100	1981-	AF-60	BMS-3
	110	1981-	AF-60P	BMS-3P
	110 NC	1981-	AF-61	BMS-5
	110 P	1981-	AF-60P	BMS-5P
	130	1981-	AF-90	
	154.20	1981-	AF-90P	
	160 NC	1981-	AF-91	
	170 NC 26	1981-	AF-90P	
			FEM-10	
			FEM-11	
	115.17 D.T.	-1989	FI-61	FI-61
	115.17 H	-1989	FI-60P	FI-60P
	136	-1989		
	145.17 H.T.	-1989		
	175.24	-1989		
	150 R.20	-	AF-90	FI-50
	150 T.20	-	AF-90P	FI-51
	150.20	-	AF-91	BMS-3
	190	-1989	AF-90P	BMS-3P
	190 T.30	-1989		BMS-5
	190.26	-1989		BMS-5P
	190	-1989	AF-71	BMS-3
	190.26	-1989	AF-70P	BMS-3P
	190.26 T	-1989	AF-90	BMS-5
	190.30	-1989	AF-90P	BMS-5P
	190.30 T	-1989	AF-91	
	190.F.26	-1989	AF-90P	
	190.H.26	-1989		
	190 PC.26	-	BN-2	PBE-11
	200	-		
	190 TURBOS.	1989-1991	A0-1	FI-11
			A0-1W	FI-11KP
			A0-1WP	FI-11P
	190.26	-1991	FI-11	NE-1
	190.30	-1991	FI-11KP	NE-1P
	190.32	-1991	FI-11P	
	190.36	-1991		
	190.42	-1991		
190.48	-1991			
240.26	-1991			
240.32	-1991			
240.36	-1991			
280.36	-1991			
330.38	-1991			
330.35	-1991			
330.36	-1991			
190.26	1992-	FI-11	FI-11	
190.30	1992-	FI-11KP	FI-11KP	
190.32	1992-	FI-11P	FI-11P	
190.36	1992-			
190.42	1992-			
190.48	1992-			



MARCA BRAND	MODELO MODEL				
FIAT VEICO	240.26	1992-			
	240.32	1992-			
	240.36	1992-			
	280.36	1992-			
	330.38	1992-			
	330.35	1992-			
	330.36	1992-			
	190.30	-1989	AF-71	FI-50	
			AF-70P	FI-51	
			AF-90	BMS-3	
			AF-90P	BMS-3P	
			AF-91	BMS-5	
			AF-90P	BMS-5P	
	190.32 T.S.	-1988	VO-V8	FI-11	
	190.30 T.S.	-1988	VO-V8P	FI-11KP	
	190.42 T.S.	-1988		FI-11P	
	242 E-15	1985-	R-30	BMS-3	
	242 E-18	1985-	R-30P3	BMS-3P	
				BMS-5	
				BMS-5P	
	242.15	-1984	CT-1	BMS-3	
	242.18	-1984	CT-1P	BMS-3P	
			CT-3	BMS-5	
			CT-3P	BMS-5P	
	264.26	1992-	R-11	VO-V8	
	264.48	1992-	R-11KP	VO-V8P	
			R-11P		
	330 F.26	-1988	VO-V8	BMS-3	
	330.26	-1988	VO-V8P	BMS-3P	
	330.30	-1988		BMS-5	
	330.35	-1988		BMS-5P	
	330.36	-1988			
	671.3A	-	AF-90	AF-90	
	671.N	-	AF-90P	AF-90P	
	642	-	AF-91	AF-91	
			AF-90P	AF-90P	
	643	-	AF-90	AF-50	
	672	-	AF-90P	AF-51	
			FEM-10	AF-60	
			FEM-11	AF-61	
	FORD	A 900	-	FO-LTC	UN-IT
		A 900 R	-	FO-LTCP	
		A 900	-	FO-TX	
		A 900 P	-	FO-TXCP	
		A 900	-	FO-TXP	
D 710 CUSTOM		-	UN-FT		
CARGO		1986-1991	NE-11P3		
TRANSCONTIN.		-	LF-6	LAS-R	
				LAS-V	
FORD (USA)		CARGO	1986-	NE-11P3	NE-11P3
	MODELOS - MODELS	-1973	MAZ-140	MAZ-140	
	MODELOS - MODELS	1974-1984	MAZ-10	MAZ-10	
			MAZ-11	MAZ-11	
	MODELOS - MODELS	1986-1987	NE-11	LF-W8	
			NE-11P		
	MODELOS - MODELS	1987-1988	FO-110	FO-110	
			FO-200	FO-200	
MODELOS - MODELS	1988-1995	NE-11	NE-11		



CAMIÓN

TRUCKS

MARCA BRAND	MODELO MODEL			
FORD (USA)			NE-11P	NE-11P
	MODELOS - MODELS 1996-1997		FO-15D FO-15DP	FO-15D FO-15DP
FREIGHTLINER	VARIOS - SEVERAL -		BS-4D	BS-4D
			HUD-1	HUD-1
			YA-4D	YA-4D
GM (CHEVROLET)	MODELOS - MODELS 1977-1988		TOYO-2	TOYO-2
	MODELOS - MODELS 1981-1982		MIT-11	MIT-11
			MIT-11P	MIT-11P
			MIT-21	MIT-21
GM (GMC)	MEDIUM TRUCK WA 1984-1986		DAT-6D	DAT-6D
	MEDIUM TRUCK WA 1984-1986		DAT-6DP1	DAT-6DP1
	MEDIUM TILTMASTER TRUCK WA 1980-		ISU-2	ISU-2
HINO	MODELOS - MODELS 1976-		TOYO-K1 TOYO-K1P	TOYO-K1 TOYO-K1P
ISUZU	NR	-	MIT-15P	MIT-15P
	NPS	-		
	NOR	-		
	TILTMASTER WA WS (S.N) 1986-1988		DAT-6D	DAT-6D
			DAT-6DP1	DAT-6DP1
ISUZU			ISU-1	ISU-1
			ISU-2	ISU-2
KENWORTH	MIDRANGER 1988-		NE-11 NE-11P	NE-11 NE-11P
MACK	MIDLINER 1982-		BH-1	BO-41
			BH-1P	
			DAV-1 DAV-1P	
	MODELOS - MODELS 1964-1986		BS-11 YA-11D	BS-11 YA-11D
MAGIREU-DEUTZ	90 M 6.3	-	BH-1	BO-4D
	90 M 6.8	-	BH-1P	BO-41
	90 M 6.6	-		
	90 M 7	-		
	90 M 9	-		
	130 M 11	-		
	130 M 13	-		
	130 M 16	-		
	130 M 9	-		
	160 M 13	-		
	208	-	BH-2	PRE-11
	308 D 18	-		
	MAN	G.180 F	-	VO-8
G.90 F		-	VO-8P	VO-8P
K.136 F		-		
K.90 F		-		
Q.136		-		
Q.136 F		-		
Q.136 FAZ		-		
Q.158 F		-		
T0.136		-		
T0.158 F		-		
T2.128		-	BH-1	HU-MN
T2.192 F-FT		-	BH-1P	HU-MNP
T2.192 FKT		-		



MARCA BRAND	MODELO MODEL			
MAN	12.232 FT	-		
	14.192 F	-		
	14.232 FKT	-		
	14.232 FT	-		
	17.232 F	-		
	18.272 FT1	-		
	19.248 F	-		
	19.262 F	-		
	19.321 F-F2	-		
	19.322 F-PK	-		
	19.322 FLT	-		
	19.361 F-FT	-		
	19.361-T	-		
	19.363 F	-		
	19.372 FAK	-		
	19.422 F-FT	-		
	19.462 F	-		
	19.582 F-F2	-		
	22.361	-		
	24.362	-		
	25.372 FNL	-		
	25.422 FNL	-		
	32.222 DF	-		
	32.240	-		
	32.281-T	-		
	32.292	-		
	32.362	-		
	32.365	-		
	32.372 DF	-		
	32.372 DFA	-		
	32.422 DF	-		
	32.422 DFA	-		
	48.448	-		
41.372 VTK	-			
41.422 VTK	-			
33.328	-	BH-1 BH-1P	HU-SX	
MERCEDES (ARGENTINA)	MODELOS - MODELS -		ME-8P	ME-9P
	MODELOS - MODELS 1996-		ME-13DP	ME-13DP
			ME-14P	ME-14P
MITSUBISHI	FUSO -1996-		MIT-21	MIT-21
			MIT-21P	MIT-21P
MITSUBISHI	FUSO 1996-		MIT-18	MIT-18
			MIT-11D	MIT-11D
			MIT-9	MIT-9
NISSAN	L.25 -1993		DAT-6	DAT-6
	M.115.17 -1993		DAT-6P	DAT-6P
	L.25.88 -1993		CHR-3	DAT-6
			NE-22P	DAT-6P
	L.79.89 -1993		CHR-5	DAT-6
	L.89.14 -1993			DAT-6P
NISSAN	MODELOS - MODELS 1988-		DAT-12	DAT-12
			DAT-6	DAT-6
			DAT-6P	DAT-6P
PIGASO	308 -		AU-1	CHR-3
			AU-HV	CHR-3P
			AU-HVP	NE-22P1
			VO-38P	
			VO-HV	

MARCA BRAND	MODELO MODEL			
PEGASO			VO-WVP	
	628	-	CHR-3	VO-VB
			CHR-3P	VO-VBP
	1236	-	CHR-5	BMS-4 BMS-5P
PIAGGIO	APE CAR	-	AF-9D	FAB-1
	APE CAR P3	-	AF-9DP	
	P 601	-	AF-9I	
			AF-9IP	
			FAB-1	
			FEM-1D	
			FEM-1I	
	APE P 50	-	FEM-1D	
	APE TM P 50	-	FEM-1I	
			NE-4	
			NE-4P	
	APE TM 703	-	AF-9D	FAB-1
	NICA 125	-	AF-9DP	
			AF-9I	
		AF-9IP		
		FAB-1		
RENAULT SAVIEM	B 70.35	-1987	CHR-3	VA-7
	B 70.45	-1987	CHR-3P	
	B 90.35	-1987	LMP-5	
	MASTER P35 D	-1987	LMP-5P1	
	MASTER T30 D	-1987	NE-32P	
	MASTER T35 D	-1987		
	B 70.45	1988-1992	CHR-3	NE-29
	B 80.45	1992-	NE-32P	
	B 90.45	1988-1992		
	B 90.50	1988-1992		
	B 110.150	1992-		
	B 110.25	1992-		
	MASTER T30 D	1987-		
	MASTER T35 D	1987-		
	MASTER TURBO	1987-		
	G 300 G	-1994	DAV-1	LAS-R
	G 320 GV	-1994	DAV-1P	LAS-V
	G 340 TI	-1994	NE-3	
	GR 305	-1994	NE-3P	
	GR 305 TURBO	-1994	NE-3P1	
	R 310	1984-	NE-3P2	
	R 360	1984-1985		
	R 360 TURBO	1984-		
	GB 115	1980-	DAV-1	RO-4D
	GB 221 TURBO	1980-	DAV-1P	RO-4I
	GC 231 TURBO	1980-		
	GF 231 TURBO	1980-		
	GR 231 TURBO	1980-		
	JK 50-60	-	BH-1	RO-15
	JK 75-90	-	BH-1P	RO-4D
	JK 110-115	-		RO-4I
	JP 11	-	BH-1	RO-4D
JP 13	-	BH-1P	RO-4I	
JP 13 TU	-			
JP 115	-			
M 100.12	-1994	NE-3	VA-10	
M 200.12	-1994	NE-3P		
M 230.12	-1994	NE-3P2		

MARCA BRAND	MODELO MODEL			
RENAULT SAVIEM	M 230.13T	-1994		
	M 230.16	-1994		
	R 350 TI	-1992		
	R 365	-1992		
	R 380	-1992		
	R 385	-1994		
	R 420	-1992		
	R1 357	-1992		
	R 360	1985-1987	NE-3	LAS-R
	R 370	1985-1987	NE-3P	LAS-V
	R 370 T 08 T	1985-1987	NE-3P2	
	S 100.06	-1994	NE-3	RO-4I
	S 100.07	-1994	NE-3P	
	S 100.08 T	-1994	NE-3P2	
	S 150	-1994		
	S 160.00 T	-1994		
	S 160.09	-1994		
	S 170.13	-1994		
	S 170.145	-1994		
	SC2/35-40	-	BH-1	LAS-R
	SC3/35-40	-	BH-1P	LAS-V
	SC4/35-40	-		
TRAFFIC	-1987	CHR-3	RO-17	
		CHR-3P		
		NE-22P		
TRAFFIC	1988-	NE-19	NE-20	
		NE-19P		
ROVER	LEYLAND ROAD	-	NE-11	LAS-V
			NE-11P	
SCANIA	110	-	BH-2	HU-SX
	111	-	FO-FR	
	140 0V T	-	FO-FRP	
	141	-	WAS-3P	
	411 0V	-		
	112 H	-1987	VO-VB	WT-1
	142 H 0V	-1987	VO-VBP	
	P 82	-1987		
	P 92	-1987		
	P 93 H-HL	1988-		
P 93 ML	1988-			
P 113 EL	1988-			
R 112 H	-1987			
R 113 E-ES	1988-			
R 113 HL-HS	1988-			
R 113 M	1988-			
R 113 MA	1988-			
R 142 E	-1987			
R 142 H	-1987			
R 142 H 0V	-1987			
R 142 M	-1987			
R 143 EL-ES	1988-			
R 143 HL-HS	1988-			
R 143 MA	1988-			
R-140 NA	1990-	HU-2P	HU-2P	
STEYR PUCH	10 S 14	-	VO-VB	AKS-1
	17 S 10	-	VO-VBP	
	19 S 31	-	NE-25	
	19 S 37	-		
	20 S 21	-		

CAMIÓN

TRUCKS

MARCA BRAND	MODELO MODEL			
STEYR PUCH	32 S 31	-		
TRUCK (USA)	MODELOS - MODELS	1995-	GM-14 GM-14P GM-25 GM-25P	GM-14 GM-14P GM-25 GM-25P
VOLKSWAGEN	MODELOS - MODELS	1991-1994	VO-VB VO-VBP	VO-VB VO-VBP
	MODELOS - MODELS	1994-	VO-3KP VO-3KP VO-4V VO-4VP VO-VB VO-VBP	VO-3KP VO-3KP VO-4V VO-4VP VO-VB VO-VBP
VOLVO	F 6	-	NE-12	NE-12
	F 7	-	NE-12P	NE-12P
	F 10	-		
	F 12 T 6	-		
	F 1020 T 6	-	NE-3 NE-3P NE-3P2	NE-12 NE-12P
	FL 6 INTER.	-	NE-12	NO-40
	FL 7 INTER.	-	NE-12P	NO-41
	FL 10 INTER.	-		
	FL 12 INTER.	-		
	FL 611	-	NE-12	
	FL 614	-	NE-12P	
	FL 616	-		
	MODELOS - MODELS	-1987	NE-1 NE-1P	NE-1 NE-1P
WHITE	VARIOS - SEVERAL	-1988	BS-4D HUD-1	BS-4D HUD-1
	VARIOS - SEVERAL	-1989	BS-2 BS-5	BS-2 BS-5

MOTOCICLETA

MOTOZIKLETA
MOTORCYCLE
MOTOCYCLETTE
MOTORRAD



THE KEY TO EXCELLENCE
GLOBALLY UNLOCKING MILLIONS OF DOORS DAILY

MOTOCICLETA



MOTORCYCLE

MOTOCICLETA

MOTOZIKLETA • MOTORCYCLE • MOTOCYCLETTE • MOTORRAD

MARCA BRAND	MODELO MODEL			
APRILIA	AFI 50	1986-1991	ZA-1	ZA-1
	AFI 125	1986-1991	ZA-1P	ZA-1P
	AS 125 R.V.	1986-1991		
	ET 50	1986-1991		
	ETX 125 PV	1986-1991		
	ETX 250	1986-		
	ETX 600	1986-		
	EUROPA 125AE	1992-		
	EXTREMA 125	1992-		
	MX 125 A	1986-1991		
	PEGASO 125	1992-1994		
	RED ROSE 50	1986-1990		
	RED ROSE 125	1986-1990		
	RED ROSE 125	1992-1994		
	RX 125	1992-		
	TUAREG 125	1986-		
	AMICO	1996-	ZA-40P1	ZA-40P1
	CLASSIC 125	1996-		
	GULLIVER	1996-		
	LEONARDO	1996-		
	MOTO 6.5	1996-		
	PEGASO	1996-		
	PEGASO 3-650	1996-		
	RALLY	1996-		
	RX 50	1996-		
SB 50	1996-			
AMICO 50	1992-	ZA-40P	ZA-40P	
CLIMBER 200	1994-			
EUROPA 50	1992-			
EUROPA 125	1994-			
FUTURA 50	1990-1991			
FUTURA 50AE	1992-			
PEGASO 50	1992-			
PEGASO 125	1994-			
PEGASO 600	1998-			
PEGASO 650	1998-			
RED ROSE 50	1992-			
RED ROSE 125	1994-			
RS 50 EXTRE.	1992-			
RX 50	1992-1996			
RX 125 EXT.	1994-			
RX 125 REP.	1994-			
SIX DAYS RX	1990-1991			
SB 50	1992-1996			
TUAREG R. 50	1994-			
ATLANTIC 125	2002-	ZA-9P1	ZA-9P1	
FILO GT 4L	-	AF-8D		
MX 250	-	AF-8DP		
RC 250	-	AF-8I		
		AF-8IP		
		FEM-2D		
		FEM-2I		
FUTURA 50AE	1990-1991	ZA-13P		



MARCA BRAND	MODELO MODEL			
APRILIA	RX 50	1990-1991		
	FUTURA 125	1990-1991	ZA-2P	
	REPLICA 50	1990-1991		
	RALLY 125	1990-1991	ZA-1	NE-8
	RX 125	1990-1991	ZA-1P	
	RED ROSE 50	1990-1991	R-11	ZA-1
			R-11KP	ZA-1P
			R-11P	
			ZA-2P	
	TUAREG 125	1992-	ZA-2P	ZA-2P
TUAREG 250	1996-	ZA-1	NE-8	
TUAREG 250	1996-	ZA-13P		
TUAREG 600	1996-	ZA-1P		
ATALA	BYTE AT10-50	1996-	ZA-40P	ZA-40P
	GREEN	1996-		
	RAKIB	1996-		
BENELLI	124	-	FEM-10	
	125 TURISMO	-	FEM-11	
	125 SPORT	1982-1983		NE-8
	125 SPORT	1982-1984	FEM-20	NE-8
	T 125	-	FEM-21	NE-8P
	125 SPORT	1984-	FEM-20	NE-8
	125 TURISMO	1984-	FEM-21	
	250 2C	-		ZA-1
	250 4C	-		ZA-1P
	354	-		
	604	-		
	750 SEI	-		
	900 SEI	-		
	EXPORT JV	-		
	G2	-		
LASER	-			
MAGNUM JV	-			
MOTOBELLA M	-			
S 50	1985-			
S 125	-			
BETA	50 CC	-1992	AF-50	ZA-1
				ZA-1P
	CHRONO	1995-	ZA-40P	
	CHRONO 502	1995-		
	QUADRA	1995-		
	TIMPO	1995-		
	KR 50	-	FAB-1	FAB-1
	KR 125	-		
	KR 250	-		
	VRS 50	-		
QUADRA	1996-	ZA-60P1	ZA-60P1	
TEMPO	1996-			
BICICLETTA- CYCLES	MOD.DANES DK	-		AS-170
	MOD.SUCCO S	-		AS-21
				AS-210
			AS-20	
			AS-21	

MARCA BRAND	MODELO MODEL				
BICILETTE - CICLOS	RALLIGH	-		LF-2 UN-1P	
BIMOTA	GPI 1	1999-	ZA-1 ZA-1P	ZA-1 ZA-1P	
	HB 2	-	NE-4	NE-6	
	HB 3	-	NE-6P	NE-6P	
	HB 3/S	-			
	KB 1	-	SUZU-13P	NE-6	
	KB 2/TT	-	SUZU-4I SUZU-4IP	NE-6P	
	SB 2	-	SUZU-13P SUZU-4I SUZU-4IP		
	SB 3	-	SUZU-6	NE-6	
	SB 4S	-	SUZU-6P	NE-6P	
	SB 4SP	-			
	BIMA	AMICA 50	-	AF-9D	UN-MBN
		AMICA 125	-	AF-9DP	
AMICA 250		-	AF-9I		
AMICA 300		-	AF-9IP FEM-1D FEM-1I		
BMW	600 RS	1984-1985	NE-6 NE-6P	NE-6 NE-6P	
	750	1984-1986	NE-7	NE-7	
	850	1984-1986			
	K 1	1987-1993			
	K 75	1984-1992			
	K 75 RT	1993-			
	K 75 S	1993-			
	K 100	1984-1992			
	K 100 RS	1993-			
	K 1100 LT	1993-1994			
	K 1100 RS	1993-1994			
	R 45	1984-1986			
	R 65	1984-1992			
	R 80	1984-			
	R 80 GS	1993-			
	R 80 R	1993-			
	R 80 RT	1993-			
	R 100 GS	1993-			
	R 100 R	1993-			
	R 100 RS	1993-			
	R 100 RT	1993-			
	F 650	1994-	ZA-6DP		
	K 1100	1994-1995	BM-HBP1	DM-HBP1	
	K 1100	1995-			
	K 1100 LS	1994-			
	K 1100 LT	1994-			
	R 1090	1995-			
	R 1100	1994-1995			
	R 1100	1995-			
	R 1100 GS	1994-			
	R 1100 R	1994-			
	R 1100 RT	1994-			
	R 640	-	NE-7	NE-6	
	R 647	-		NE-6P	
	R 750	-			
	R 757	-			

MARCA BRAND	MODELO MODEL			
BMW	R 667	-		
	R 66 S	-		
	R 940	-		
	R 100 RS	-		
	R 1007	-		
	R 100 S	-		
CAGIVA	125 ALETA	1986-		ZA-1
	200 ELEFANT	1984-		ZA-1P
	350 ALA	1984-1987		
	ALETA EL 125	-		
	COCOS 50	-1991		
	CRESTA 350	1986-1987		
	DC 350	1984-1987		
	RX 250	1984-		
	SST 250 ALA	1984-		
	SST 250 RL	1984-		
	SST 250 RL	1984-1987		
	SX 250	1984-		
	SX 350	1984-1987		
	SXT 250	1984-		
	WMX 250	1984-		
	WMX 500	1984-		
	650	-	SUZU-13P SUZU-4I SUZU-4IP	SUZU-13P SUZU-4I SUZU-4IP
	100 ELEFANT	1992-	KAW-6P	
	ALETA ORO L	1986-	R-6I R-6IP2 R-6IP3	ZA-1 ZA-1P
	ALETA ROSA	1986-	SUZU-13P	ZA-1
	AR 350	1984-1986	SUZU-4I	ZA-1P
	ELEFA 2 125	-	SUZU-4IP	
	ELEFA 2 200	-1984		
	ELEFA 2 350	1984-1985		
ELEFA 2 600	-			
K 3	1991-1992			
SST 125	1984-			
SXT 125 N	1984-			
W 8	1984-			
BLUES 125	-	R-1	R-1	
FRECCIA 125	-	R-1P	R-1P	
FULL FUN 125	-1990			
MITO 125	-1990			
MMX 125	-1990			
TAMANACO 125	-			
CITY	1993-1994	KAW-6P	KAW-6P	
ELEFA 900	1992-			
MITO	1992-			
MITO 125	1991-1992			
MITO CARENA	1991-1992			
MITO EV	1994-1995			
MITO LAWSON	1993-			
MITO RACING	1991-1994			
MITO RACING	1994-			
PRIMA	1993-			
SUPER CITY	1993-			
CITY	1994-	ZA-8P	ZA-8P	
CITY LUCKY	1994-			
CITY PASSING	1994-			

MOTOCICLETA

MOTORCYCLE

MARCA BRAND	MODELO MODEL			
ORJIVA	SUPERCITY	1994-		
	ELIFA 90	-1999	FI-1	ZA-1
	ELIFA 150	-1999	FI-1P	ZA-1P
	FRECCIA 125	1991-1992		
	LUCKY 350 E	1987-1991		
	LUCKY 350 EX	-1991		
	N 90	1991-1992		
	PARIS DAKAR	-1991		
	T 350 E	1987-1991		
	T4 350	-1991		
	T4 350 B	1987-1991		
	T4 500 E	-1991		
	HD 175	-	FEM-10	
	HD 250	-	FEM-11	
	RIVER 600 C	1995-	ZA-4DP	
	ROADSTER 125	1994-	ZA-1	
			ZA-1P	
	S.CITY 125	1992-	ZA-4DP	ZA-4DP
	SST-SX 125	-1994	FEM-10	ZA-1
	SST-SX 250	-1994	FEM-11	ZA-1P
	SST-SX 350	-1994		
	SXT 125	1994-	SUZU-13P	
			SUZU-4I	
			SUZU-4IP	
	TRIAL 125	-		CL-2I
	TRIAL 350	-		CL-3I
	W 12 350	1994-	ZA-1	ZA-1
	W 16	1992-	ZA-1P	ZA-1P
CINQATTI	GRINGO G1-4M	-		ZA-1
	GRINGO LUX	-		ZA-1P
EIMM	SMILY	-		NE-6
				NE-6P
DEBBY	ATLANTIS 100	2003-	ZA-9P1	ZA-9P1
	MULHACEN	2000-		
	PREDATOR	1999-		ZA-9P1
ORM-HERCULES	125 G SPEC.	-		NE-6
	175 GS	-		NE-6P
	250 GS	-		
	505 P	-		
	521	-		
525 S	-			
DUCATI	125 REG. 3T	-		NE-6
				NE-6P
	250 SCRAMBL.	1982-	FEM-10	NE-6
	350 GTV	1982-	FEM-11	NE-6P
	350 SCRAMBL.	1982-	FEM-20	
	450 SCRAMBL.	1982-	FEM-21	
	500 2 CIL.	1982-		
	500 GTL	1982-		
	500 SL PANT.	1982-		
	700 GT-SS	1982-		
	750 SPORT	1982-		
	800 GT-GTS	1982-		
	900 2 CIL.	1982-		
	900 REPLICA	1982-		
	900 SD-SS	1982-		
	750 FI DESMO	1984-	FEM-10	NE-8
	750 GTL-XL	1984-	FEM-11	
	750 SL-TL	1984-	FEM-20	



MARCA BRAND	MODELO MODEL			
DUCATI	500 GTV-SL	1984-	FEM-21	
	500 SPORT B.	1984-		
	600 SL-TL	1984-		
	900 DARMAR	1984-		
	350 SPORT	1993-	KAW-6P	KAW-6P
	400 SPORT	1993-		
	600 MONSTER	1994-1995		
	600 S.SPORT	1994-		
	750 SS	1991-1992		
	851 S	1991-1992		
	851 SPORT	1991-1992		
	888 RACING	1993-		
	888 S.P4	1991-1992		
	888 S.P5	1993-		
	900 M	1993-		
	900 MONSTER	1994-		
	900 S.L.	1991-		
	900 S.S.	1991-1992		
	900 SS	1991-		
	907 La.	1991-1992		
	CARENATA	1991-		
	CUPOLENO	1991-		
	750 FI DESMO	1990-1991	FEM-10	NE-8
			FEM-11	
			FEM-20	
			FEM-21	
			FI-6I	
			FI-6IP3	
	750 FI DESMO	1987-	ZA-13P	ZA-13P
	851 SPORT	1989-		
	907 La.	1989-		
	DESMO 900 SS	1989-		
PASO 900	1989-			
750 INDIANA	1990-1991	FI-6I	FI-6I	
750 SPORT B.	1990-1991	FI-6IP3	FI-6IP3	
PASO 750 LTD	1990-1991			
851 S	1990-1991	FI-6I	ZA-1	
900 S.S.	1990-1991	FI-6IP3	ZA-1P	
907 La.	1992-	ZA-4DP	ZA-4DP	
INDIANA 350	1987-		ZA-1	
INDIANA 650	1987-		ZA-1P	
INDIANA 750	1987-			
PASO 350	1987-	ZA-13P	ZA-1	
PASO 750	1987-		ZA-13P	
			ZA-1P	
ST 2	1992-	KAW-6P		
TANTIC MOTOR	50.1 OASIS	1984-1991		ZA-1
	CABALLERO	1992-		ZA-1P
	CABALLERO M	1984-1991		
	CLAN M	1982-		
	CLUBMAN	1993-		
	ISSIMO	1982-		
	JOY JV	1984-1991		
	JOY MK	1984-1991		
	JOY VK	1984-1991		
	KOALA	1993-		
K-ROO	1992-			
RAIDER 50.1	1984-1991			
RAIDER 125LC	-			

MARCA BRAND	MODELO MODEL			
PANTIC MOTOR	BALLY 200	-		
	TENTER TD	1984-1991		
	TRIAL 50	1982-		
	TRIAL 201	-1991		
	TRIAL 240	-1991		
	TRIAL 241	-1991		
	TRIAL 242	-1991		
	TRIAL 245	-1991		
	TRIAL 300	-1991		
	TRIAL 301	-1991		
	TRIAL 303	-1991		
	TRIAL 305	-1991		
	TRIAL KID	1984-1991		
	TRIAL S.3	1984-1991		
	TRIAL S.7	1984-1991		
	125	1984-	ZA-1	ZA-1
	125 SPORT	1984-	ZA-1P	ZA-1P
	ISSIMO 50	1984-		
	RAIDER 50	1984-		
	RAIDER GT 50	1984-		
	SPRINTER JV	1984-		
	SPRINTER 50	1984-		
	SPRINTER MUL	1984-		
	STRADA 50	1984-		
	STRADA 125	1983-		
	ENDURO 50	1985-		NE-B
	RAIDER 125	-		
	TRIAL 50	1985-		
	TRIALMATIC	1985-		
	GR.TUR.50 CC	-		NE-B NE-6P
	HP1 125	-	FI-61 FI-61P3	FI-61 FI-61P3
	LEI 50 CC	-		IMS-1 IMS-1P
	TRIAL 125	-		NE-B
	TRIAL 200	-		ZA-1 ZA-1P
	GARILLI	BASIC 50	1985-	
BASIC2 50		1985-		ZA-1P
FORMUNO		1988-1991		
GARY		1992-		
GARY DUE 50		1988-1991		
GARY UNO 50		1988-1991		
SAHEL 50 ES		-1991		
TEAM JV 50		-1991		
TEAM BIMATIC		-1991		
TEAM Matic		-1991		
URKA AC-LCSH		-1991		
VIP NOV 50		-1991		
CICLONE 50		-1980		AF-19
CICLONE SV 5		-1980		AF-19P
EUREKA FLEX		-		IMS-1
JUNIOR T 50		1982-1986		IMS-1P
JUNIOR GT 50		1982-1986		ZA-1
JUNIOR K100S		-1986		ZA-1P
NOI 50		-1986		
VIP 1-NSH		-		
VIP 2-NSH		-		

MARCA BRAND	MODELO MODEL			
GARILLI	VIP 3-NSH	-		
	VIP 4-NSH	-		
	CICLONE WM	1986-1988	ZA-1	ZA-1
	CICLONE LC	1986-1988	ZA-1P	ZA-1P
	NOI BIMATIC	1987-1991		
	NOI Matic	1987-1991		
	NOI TL 50	1987-1991		
	GRAN TURISMO	-		NE-B NE-6P
	GTA 125	-	FI-61 FI-61P3	FI-61 FI-61P3
	SUPER VIP	1985-1989	AF-6D	ZA-1
	TIGER 125XLE	-		ZA-1P
	TR5 125 S.M.	-		
	XR 125 TIGER	-		
	TIGER XR0	-	ZA-1 ZA-1P	
	GILERA	50 GSA LUS	-	AF-6D
50 TS-GSA		-		
50 R1		-		ZA-2P
50 BALLY		-		
50 RC TR0.		-		
50 TREND		-		
50 SIOUX A		-	ZA-40P	ZA-40P
125 APACHE		1991-		
125 CROMO		1991-		
125 FREE ST		-		
125 GR S.P		-		
125 SIOUX		-		
300 NORDWES		1993-		
600 NORD WE		-		
600 R		1993-		
600 RC		1991-		
RC 750 R		-		
TYPHOON		-1995		
125 CX AE		-	ZA-1	ZA-1
125 GRF		1993-	ZA-1P	ZA-1P
125 R		1993-		
500 AE	1993-			
ARIZONA 125	-			
ARIZONA 250	-			
BULLIT AE	1992-			
BULLIT KICK	1992-			
BULLIT MIX	1993-			
RC 600 R	1991-			
RTX 125-200	-			
RV 125-200	-			
RX 125-200	-			
SIOUX AE	1993-			
125 GR1-TG1	-		NE-B NE-6P	
150	-		NE-6P	
ECO 50	-			
125 MIX	-1991	FI-1	FI-1	
125 RC	-1991	FI-1P	FI-1P	
125 SPO1	-1991			
125 SPO2	-1991			
125 XR2 R.	-1991			
125 TG2	-	AF-6D	ZA-1 ZA-1P	



MOTOCICLETA

MOTORCYCLE

MARCA BRAND	MODELO MODEL			
GILERA	200 T 4	-	AF-5D	
	200 T45	-	AF-9DP	
	CUSTOM 125	-	AF-9I	
	CUSTOM 200	-	AF-9IP	
			FEM-1D	
			FEM-1I	
	250 NGR	-	FI-6I	FI-6I
			FI-6IP3	FI-6IP3
				ZA-1
				ZA-1P
	350 DAKOTA	-1998	FI-6I	FI-6I
	500 DAKOTA	-1998	FI-6IP3	FI-6IP3
	500 SATURNO	-1998	ZA-2P	ZA-2P
	600 RC	-1998		
	CBA 50	-1991		ZA-1
			ZA-1P	
NCR 50	2000-	ZA-9P1	ZA-9P1	
NEXUS	2000-			
RUNNER	2000-			
STORM 50	1995-	ZA-7DP		
TYPHOON	1995-			
HARLEY DAVIDSON	FLH 1340 EL	-	HS-1	NE-6
	FLHC 1340 EL	-	HS-1D	NE-6P
	FLHC 1340 S.	-	HS-2	NE-8
	FLT 1340 TO	-	HS-2D	
	FLTC 1340 TO	-	HS-3	
	FXB 1340 ST.	-	HS-3D	
	FXE 1340 SL	-		
	FXPS 1340 SU	-		
	FXR 1340 SL	-		
	FXS 1340 LOW	-		
	FXWG 1340 WI	-		
	ZLH 1000 SP	-		
	ZLS 1000 BO	-		
	VARIOS - SEVERAL	-1998	DS-6	
	VARIOS - SEVERAL	1990-	CHI-1T	CHI-1T
HERCULES	K 125	-	YAMA-21I	
			YAMA-21IP	
HONDA	125	1980-	SUZU-13P	NE-6
	125 E	1980-1982	SUZU-6I	NE-6P
	125 S	1980-	SUZU-6IP	
	125 SILHO.	1980-		
	CB 125 T2	1982-		
	125 E	1982-	SUZU-13P	NE-6
			SUZU-6I	
			SUZU-6IP	
	125 LEAD	1991-	HOND-4I	HOND-4I
	600 VTR.	1990-	HOND-6IP1	HOND-6IP1
	CBR 600 F	1987-		
	CBR 1000	1991-1992		
	VF 750 C	1990-		
	VFR 750 FX	1990-1991		
	VFR 750 FL	1990-1991		
VFR 750 P.	1990-1991			
VFR 750 R	1990-1991			
XRV 750 A.	1992-			
125 VISION	-	SUZU-13DP	SUZU-13DP	
		SUZU-4D	SUZU-4D	
		SUZU-6DP	SUZU-6DP	

MARCA BRAND	MODELO MODEL			
HONDA	200 R	-1989	HOND-10	HOND-10
	CB 450	1986-	HOND-10D	HOND-10D
	CB 650	1984-	HOND-10DP	HOND-10DP
	CB 750	1986-1991	HOND-10P	HOND-10P
	CB 900	1984-	HOND-4D	HOND-4D
	CB 1100	-1991	HOND-6DP	HOND-6DP
	CBX 500	1984-1987	HOND-6DP2	HOND-6DP2
	CBX 550	1984-	HOND-6I	HOND-6I
	CBX 650	1984-	HOND-6P	HOND-6P
	CBX 750	1986-1991		
	CR 500	1984-1987		
	CX 650	1986-		
	FT 500	1984-1987		
	GL 650	1984-		
	GL 1100	-1991		
NS 400	1986-			
VF 500	1984-1987			
VF 750	1986-1991			
VF 1000	-1991			
VF 1100	-1991			
VFR 750	1986-1991			
VT 500	1986-1987			
XLV 750	1986-1991			
YT 1100	-1991			
350 FOUR	1979-1981	HOND-7I	NE-6	
500 FOUR	1979-		NE-6P	
350 FOUR	1981-	HOND-6D	NE-6	
400 FOUR	1981-1982	HOND-6DP	NE-6P	
CB 400 N	1979-1981	HOND-6DP2		
CB 400 N	1981-1982			
CB 750 K	1980-			
CM 400 T	1981-1982			
CX 500	1981-1982			
400 CBT	1979-	HOND-3I	NE-6	
500 CBT	-		NE-6P	
500 FOUR	1976-1979	HOND-2I	NE-6	
			NE-6P	
500 FOUR K	1979-	HOND-6D		
1100 GOLD W.	-	HOND-6DP		
CB 650	-	HOND-6DP2		
CB 750 F.	1980-			
CB 750 FI	1981-			
CX 500	1979-1981			
600 R	1983-	VO-V8P1	VO-V8P1	
600 R	1983-			
1200 G.W.	-1991			
GL 1200	-1991			
GL 1500	-1991			
GX 1200 DL	-1991			
VF 750 C	1982-1990			
VF 750 CU.	1982-			
VF 750 S.	1982-			
XL 350 R	1986-1991			
XL 350 RF	1986-1991			
500 R CROSS	1982-	HOND-4D	NE-6	
CB 250 N	1986-	HOND-4DP		
CB 250 RS	1986-	HOND-4DP2		
CB 750 C	1979-			
CB 750 K	1979-1980			

MARCA BRAND	MODELO MODEL			
HONDA				
	CB 900 B.	1982-		
	CB 900 F	1982-		
	CB 900 FI	1982-		
	CB 1100 B	-		
	CBR 250 F	1980-		
	CBX 400 F	1982-		
	CBX 400 FC	1984-		
	CBX 400 FI	1984-		
	CDI 125 G	1984-1986		
	FT 500	1983-1984		
	RAVEL 250	1980-		
	REBEL 250	1980-		
	XL 500 B	1982-1984		
	XL 500 S	1982-		
	XR 500 B	1982-1984		
	600 PROA.	1985-1991	HOND-4D	HOND-4D
	600 VTR.	1985-1991	HOND-4DP	HOND-4DP
	CBX 1000 S.S	-	HOND-4DP2	HOND-4DP2
	CX 500	1984-	HOND-4I	HOND-4I
	MTX 200 B	-1980	HOND-4IP	HOND-4IP
	NTV 650	1984-1992		
	ST 1100	-1991		
	TRX 200 SX	-1980		
	VF 400 F	1980-		
	VFR 400 B	1980-		
	XL 200	-1980		
	XL 200 PD	-1980		
	XL 500 B	1984-		
	XL 600	-1984		
	XL 600	1985-1991		
	XL 600 LM	1985-1991		
	XL 600 B	1985-1991		
	XL 600 RM	1985-1991		
	XL 600 RX	1985-1991		
	XR 500 B	1984-		
	600 V T.	1992-	HOND-4D	HOND-4D
	CB 750	1992-	HOND-4DP1	HOND-4DP1
	NTV 650	1992-1996	HOND-4DP2	HOND-4DP2
	NX 650 D	1983-		
	VFR 750	1980-		
	VT 600	1980-		
	650 G.W.	1983-1991	HOND-4D	HOND-4D
	ASPENCADE	-1991	HOND-4DP	HOND-4DP
	CB 250 N	1982-1985	HOND-4DP2	HOND-4DP2
	CB 250 RS	1982-1985		
	CB 400 L	1980-		
	CB 400 N	1982-		
	CB 500	1982-		
	CBR 1000	-1991		
	CBX 125	1984-		
	CBX 1100 GC.	-		
	CL 250 N	1982-1985		
	CL 250 S	1982-1985		
	CM 250 C	1982-1985		
	CX 500	1982-1984		
	ENTERSTAT	-1991		
	G.WING 1.2	-1991		
	GL 500	1982-		
	ST 1100 FE.	1991-		



MARCA BRAND	MODELO MODEL			
HONDA				
	VT 500	1980-1984		
	X 400 B	1980-		
	XL 125 PD	1984-1986		
	XL 125 PJ	1980-		
	XL 125 PD	1984-1986		
	XL 125 R	1984-1986		
	XL 125 R2	1980-		
	XL 125 SD	1984-1986		
	XL 200 P2	1980-1991		
	XL 200 PD	1980-1991		
	XL 200 B	1980-1991		
	XL 200 R2	1980-1991		
	750 AFRICA	1991-	HOND-10	HOND-10
			HOND-100	HOND-100
			HOND-100P	HOND-100P
			HOND-10P	HOND-10P
			HOND-4D	HOND-4D
			HOND-4DP1	HOND-4DP1
			HOND-4DP2	HOND-4DP2
	750 FOUR	1975-	HOND-4D	
			HOND-4DP	
			HOND-4DP2	
			HOND-4I	
			HOND-4IP	
	750 RXLV	1985-	HOND-4I	HOND-4I
	750 XLV	1985-	HOND-4IP	HOND-4IP
	CB 125 T	1980-		
	CN 250	-1991		
	MTX 125 B	1980-		
	NX 125	1984-		
	NXR 650 A.	1984-1990		
	PC 800	1985-1991		
	SPACY SCOOT.	-		
	XL 250 B	-1991		
	BIG RED 125	1980-	HOND-10	HOND-10
	CBR 1000	-1992	HOND-100	HOND-100
	CN 250	1991-1994	HOND-100P	HOND-100P
	CRM 125	1980-1992	HOND-10P	HOND-10P
	CX 500	1984-1987		
	MTX 200	-1980		
	NH 125 PEAD	1980-		
	NTV 650	1984-1994		
	NX 650	1991-1994		
	PK 50 DX WA.	1992-		
	SA 50 M.VIS.	1992-		
	SPACY	-		
	ST 1100	-1992		
	TRX 200	-1980		
	VF 400	1980-		
	VFR 400	1980-		
	VFR 750	1991-		
	XL 125	1984-1986		
	XL 125	1980-		
	XL 200	-1991		
	XL 250	-1991		
	XL 500	1984-		
	XL 600	1984-		
	XR 500	1984-		
	CAMINO S 50	-		NL-8

MOTOCICLETA

MOTORCYCLE

MARCA BRAND	MODELO MODEL			
HONDA	CBX 900 RH	-		
	CB 125 S	1979-	HOND-4D	NE-8
			HOND-4DP	NE-6P
			HOND-4DP2	
			HOND-4I	
			HOND-4IP	
	CB 125 SL	1982-	HOND-4I	NE-6
	XL 125	1982-1983	HOND-4IP	NE-6P
				NE-8
	CB 125 X	1982-	HOND-4I	NE-6
	CBX 125	1982-1983	HOND-4IP	NE-6P
	CS 125	1982-		
	CB 500	1994-1997	HOND-4D	HOND-4D
	CB 1000	1993-	HOND-4DP1	HOND-4DP1
	CBR 900 RR	1994-	HOND-4DP2	HOND-4DP2
	CBR 1000	1992-	HOND-4I	HOND-4I
	CRM 125	1998-	HOND-4IP1	HOND-4IP1
	NSR 125 F	1998-		
	NSR 125 B	1998-		
	NSR 125 B SP	1998-		
	CB 600S	1997-	HOND-24P	HOND-24P
	CBF 500	2004-		
	CBF 600	2004-		
	CBR 900 RR	1997-		
	CBR 1000 F	1997-		
	FORZA	2005-		
	NTV 650	1997-1998		
	NX 650	1997-		
	SFX 50	1997-		
	SH 50	1997-		
	SH 100	1997-		
	SJ 100 BALI	1997-		
	ST 1100	1987-		
	CB 650 F	1979-1982		NE-6
				NE-6P
	CB 650 CUST	-	HOND-4D	NE-8
	CB 650 SC	-	HOND-4DP1	
			HOND-4DP2	
	CB 750 F	1979-	HOND-7D	NE-6
			HOND-7I	NE-6P
	CB 750 FO.	1979-	HOND-7I	
	CBX 125	1983-1984	SUZU-13P	NE-6
	MH 125	1983-	SUZU-4I	NE-6P
	XL 125	1983-	SUZU-4IP	NE-8
	CBX 900	1984-	HOND-19	
		HOND-19D		
		HOND-19DP		
CG 125	1993-	HOND-26DP1	HOND-26DP1	
ECONO POW'ER	1993-	HOND-26P1	HOND-26P1	
CMX 400 SC.	-1991	SUZU-13P	SUZU-13P	
		SUZU-4I	SUZU-4I	
		SUZU-4IP	SUZU-4IP	
CB 250	-1991	HOND-19	HOND-19	
		HOND-19D	HOND-19D	
		HOND-19DP	HOND-19DP	
		HOND-19P	HOND-19P	
		HOND-4I	HOND-4I	
		HOND-4IP	HOND-4IP	

MARCA BRAND	MODELO MODEL			
HONDA	DYLAN 125	2004-	ZA-1P1	ZA-9P1
	PHANTOM 150	2003-		
	PS 125I	2000-		
	PS 150I	2000-		
	SH 125I	2000-		
	SH 150I	2000-		
	LEAD 100	2003-	HOND-28P	
	MTX 125	1994-1992	HOND-19	HOND-19
	MX 125	1994-1992	HOND-19D	HOND-19D
			HOND-19DP	HOND-19DP
			HOND-19P	HOND-19P
			HOND-4D	HOND-4D
			HOND-4DP1	HOND-4DP1
			HOND-4DP2	HOND-4DP2
			HOND-4I	HOND-4I
			HOND-4IP1	HOND-4IP1
	NH 50	-1991	AF-6D	NE-8
	PA 50 DLX	-1991		
	PK 50 DX	-1991		
	PX 50 S	-1991		
	SA 50	-1991		
	PK 50	1993-	HOND-25P2	HOND-25P2
	SA 50 P	1993-	HOND-4I	HOND-4I
	SH 50	1993-1996	HOND-4IP1	HOND-4IP1
	SFX 50	1994-1995	HOND-28	
	SJ 50 BALI	1994-1995	HOND-28D	
			HOND-28DP	
	SH 50	1991-1993	VO-V8P1	HOND-38DP2
				HOND-38P2
				VO-V8P1
	VFB 750	1989-1991	HOND-28	HOND-28
			HOND-28D	HOND-28D
			HOND-28DP	HOND-28DP
			HOND-28P	HOND-28P
	VFB 750	1989-1991	HOND-28DP	HOND-28DP
		HOND-28P	HOND-28P	
ITALJET	ASCOT	1992-	YAMA-27	YAMA-27
	BAZOOKA	1992-	YAMA-27D	YAMA-27D
	TIFFANY	1992-	YAMA-27DP	YAMA-27DP
			YAMA-27P	YAMA-27P
	DRAGSTER	1998-	ZA-9P	ZA-9P
	FORMULA 50	1996-	ZA-4DP	
PISTA	1994-	YAMA-27DP	YAMA-27DP	
SCOOP	1994-	YAMA-27P	YAMA-27P	
KAWASAKI	400 CUSTOM	1991-	KAW-6P	KAW-6P
	750 CUSTOM	1991-		
	EN 500	1993-		
	KLX 650	-		
	TWIN CAM	1992-		
	VN 1500 SUMO	-		
	VN 1500	2003-		
	ZXR 400	1991-		
	ZXR 1100	1991-		
	ZZR 250	-		
ZZR 600	-			
ZZR 1100	1991-			
400 GT	1988-1985	KAW-8	KAW-8	
400 KZ	1988-1985			



MARCA BRAND	MODELO MODEL			
KAWASAKI	400 Z	1985-1985		
	400 ZR	1985-1985		
	500 LTD	1982-	KAW-3	KAW-3
	GPZ 250	-		
	GPZ 300	-		
	GPZ 450	-		
	GPZ 500	1982-1984		
	GPZ 600 R	-		
	GPZ 750	-		
	GPZ 750 R	-		
	GPZ 900 R	-		
	GPZ 1000	-		
	GPZ 1100	-		
	GPZ 1300	-		
	KL 250	-		
	KLX 250	-		
	VOYAGER	-		
	Z 250 C	-		
	Z 250 GP	-		
	Z 250 LTD	-		
	Z 300	-		
	Z 450	-		
	Z 550	1982-1984		
	Z 600	-		
	Z 750	-		
	Z 750 LTD	-		
	Z 750 TURBO	-		
	Z 900	-		
	Z 1000	-		
	Z 1100	-		
	Z 1300	-		
	900 ZI	-	KAW-4	KAW-4
	1000 GTR	1984-1991	KAW-3	KAW-5
	1300 Z	1985-1991	KAW-5	KAW-5P
	CS 250	1984-1988	KAW-5P	
	FX 400 R	1984-		
	GPZ 300	1984-		
	GPZ 500	1984-1990		
	GPZ 750	1984-1991		
	GPZ 900 R	-1985		
	GPZ 1000	1984-1991		
	GPZ 1100	1984-		
	GT 250	1984-1991		
	GTR 1000	1984-1991		
	KL 250	1984-1988		
	KLX 170	1984-1990		
	KLX 650	1980-1991		
	LTD 450	1984-		
	SR 650	1980-1991		
	TENGAJ 650	1980-1991		
VN 750 T	1984-1991			
Z 250	1984-			
Z 300 B	1984-			
Z 400	1984-			
Z 440	1984-			
Z 550	1984-1990			
Z 750	1985-1992			
Z 1000 RZ	1984-1991			
Z 1100	1984-			

MARCA BRAND	MODELO MODEL			
KAWASAKI	Z 1300	1986-1991		
	ZN 1300 V	1986-1991		
	ZR 500	1984-1990		
	ZX 550	1984-1990		
	ZX 1000	1984-1991		
	ZXR 750	1985-1992		
	AR 125	-1986		NE-6
	KDX 175	-		NE-6P
	KE 125	-1986		
	KE 175	-		
	KMX 125	-1986		
	KX 125	-1986		
	EN 500	-1991	KAW-2I	KAW-2I
	KLX 250	1986-1986		
	ER 5	2002-	KAW-9P	KAW-9P
	NINJA ZX-6R	2002-		
	NINJA ZX-7R	2002-		
	NINJA ZX-9R	2002-		
	NINJA ZX-12R	2002-		
	Z 750	2004-		
	ZR 7	1999-		
	ZZR 1200	2002-		
	GLX 1100	1992-	KAW-5	KAW-5
	GPX 600	1990-1990	KAW-5P	KAW-5P
	GPZ 500	1987-		
	GPZ 500 S	1994-		
	GPZ 600	1986-1990		
	KDX 250 D	-		
	KL 250	1986-		
	KLX 500	1994-		
	KLX 250	1986-		
	KX 250	1986-		
	LTD 450 C	1986-		
	SJ 50 BALI	1994-		
	Z 650	1982-		
	ZL 600	1990-1992		
	ZZR 600	1990-1992		
	GPZ 400	-	KAW-3	KAW-3
	GPZ 550	-	KAW-4	KAW-4
	LTD 450	-	SUZU-13P	
	Z 400	-	SUZU-4I	
	Z 400 TW	-	SUZU-4IP	
	Z 440 LTD	-		
	Z 550 LTD	-		
	GPZ 750	-1984	KAW-3	
	Z 400 F	1981-1982		
	Z 400 J	1981-1982		
	Z 500	1981-		
	Z 750	1984-1985		
	KH 400	1979-	KAW-4	
OH 400	1979-	SUZU-130P		
Z 400	1979-1981	SUZU-13P		
		SUZU-4D		
		SUZU-4DP		
		SUZU-4I		
		SUZU-4IP		
KL 600 S	1986-1991	KAW-2D	KAW-2D	
KLX 600	1986-1991	KAW-2I	KAW-2I	
KLX 600	-	KAW-1D	KAW-1D	

MOTOCICLETA

MOTORCYCLE

MARCA BRAND	MODELO MODEL				
KAWASAKI	Z 400	-	KAW-11	KAW-11	
	Z 650 F	1984-1991			
	Z 650 S	1984-1991			
	Z 650 SR	1984-1991			
	KLR 600 S	1994-1995	KAW-7P	KAW-7P	
	KLR 650	1994-1995			
	NINJA ZX-9R	1994-1995			
	ZXR 750	1993-1994			
	ZZR 600	1994-1995			
	ZZR 1100	1993-1994			
	KLV 1000	2004-	SUZU-120P	SUZU-120P	
	LDT 600	1995-	KAW-60P	KAW-60P	
	VN 800	1995-			
	Z 250 A	1982-	KAW-21		
	Z 250 C	1982-	KAW-8		
	Z 250 J	1982-	KAW-40		
	Z 400	1979-1988	KAW-8		
	Z 400	1981-			
	Z 400	1981-1984	KAW-21		
	Z 440 H	1982-	KAW-20		
	Z 440 J	1982-	KAW-21		
	Z 460 LTD	1982-			
	ZL 600 ELL	1997-	KAW-5	KAW-5P	
	ZXR 400	1990-1991	KAW-20	KAW-20	
	ZXR 1100	1990-1991			
	ZZR 1100	1990-1991			
	KTM	ER 5	2003-	ZA-9P1	ZA-9P1
		MOOKI20 - MOOKLS	1998-	VO-VBP1	VO-VBP1
KYMCO	CX 50	1997-	HOND-4I	HOND-4I	
	K 125B	1997-	HOND-41P	HOND-41P	
	KB 50	1997-			
	SNIPER 50 GP	1997-			
HEROISM	HEROISM	1997-	KYM-10P	KYM-10P	
			KYM-1P	KYM-1P	
LAMBRETTA	LUI 50	-		IMS-3 IMS-3P NE-56	
LAVIEGA	50 ATLAS	1980-1990	ZA-1	ZA-1	
	50 GASCHO	1980-	ZA-1P	ZA-1P	
	125 CU RIDE	1980-1990			
	125 FORMULA	1980-1990			
	125 GS LES.	1984-			
	125 L ELEG.	1984-			
	125 LB CUS.	1984-			
	125 LB SAB.	1984-			
	125 LB UND	1984-			
	125 LESMO G	1980-1990			
	125 LZ CUS.	1984-			
	350 LESMO	1984-			
	600 ATLAS O	-			
	1000 SFC	1980-			
	VO 1000 B	-			
	50 LZ	-	NE-8	NE-8	
	125 LZ	1978-	NE-6	NE-6	
	125 LZ C.	1978-	NE-6P	NE-6P	
	125 LZ S.	1978-	NE-8		
	500 4T	-	SUZU-13P	NE-6	
	500 SFC	-	SUZU-8I	NE-6P	



MARCA BRAND	MODELO MODEL				
LAVIEGA	750	1978-	SUZU-41P		
	1000	1978-			
	1000 JOTA	-			
	1000 JOTA120	-			
	1000 NGS	-			
	1200	1978-			
	1200 TS	1978-			
	PHOENIX	2003-	ZA-8P	ZA-8P	
	LINCE	125 SERVETTE	-		CL-31
		150 SERVETTE	-		CL-31
		300 SERVETTE	-		
	MAICO	GM STAR 250E	-		CL-21
GM STAR 500E		-		CL-31	
GM STAR 510		-		NE-6 NE-6P NE-8	
MALAGUTI	50 MDX	1986-1991	ZA-1	ZA-1	
	50 MEX	1986-1991	ZA-1P	ZA-1P	
	50 MFX	1986-1991			
	50 MUX	1986-1991			
	CUSTOM	1986-1991			
	FIFTY FULL	1986-			
	FIFTY HF 50	1986-1991			
	FIFTY TOP 50	1986-			
	RUNNER YLC	1986-1991			
	TOP 50	1986-1991			
	125	1986-		ZA-1	
	125 RUNNER	1986-		ZA-1P	
	CAVALCONE 80	-			
	CHOPPER 25	-			
	CHOPPER 40	-			
	CHOPPER 80	-			
	DRIBBLING	1986-			
	DROP	-			
	DUNE ES	1986-			
	DUNE KS	1986-			
	FIFTY	-			
	FIRE BIRD	-			
GRIZLY UNO	-				
MAX ENDURO	1986-				
NEW DRIBLING	-				
PULL CR	-				
CENTRO SL	1994-	ZA-40P	ZA-40P		
CROSSER 50	1994-				
F 10	1994-				
PHANTOM	1994-				
RS	1991-				
F 10 JET	1992-	YAMA-77	YAMA-77		
		YAMA-77D	YAMA-77D		
		YAMA-770P	YAMA-770P		
		YAMA-77P	YAMA-77P		
		YAMA-36P	YAMA-36P		
FIREFOX F15	1986-1993	ZA-9P	ZA-9P		
MADISON	2003-				
RST 50	1991-1992	ZA-13P	ZA-40P		
		ZA-40P			
MALANCA	125 MARKET	-	ZA-1	ZA-1	
			ZA-1P	ZA-1P	
	BIG	-		ZA-1	

MARCA BRAND	MODELO MODEL				
MALANCA	GTS 4 4M	-		ZA-1P	
	GTS 5	-			
	LP	-			
	LPBL	-			
MOR	BOOSTER	1995-1997	ZA-4DP	ZA-4DP	
	EVOLIS	1995-			
	FORTE	1995-			
	NEW SORRISO	1995-			
	BOOSTER	1998-	ZA-9P1	ZA-9P1	
	KILIBRE	2003-			
	OVETTO	1998-			
	BOOSTER M	-	YAMA-27	YAMA-27	
	EVOLIS	-	YAMA-27D	YAMA-27D	
	SCOOTER	-	YAMA-27DP	YAMA-27DP	
MORR	SORRISO	-	YAMA-27P	YAMA-27P	
	TARGET	-	ZA-4DP	ZA-4DP	
	BREEZE LUSSO	-		ZA-1	
	BULL	-		ZA-1P	
	CRAZY	-			
	PONY	-			
	SONO	-			
MONTISA	250 ENDURO	-1991		CL-2I	
	250 KING SC.	-1991		CL-3I	
	240 TRIAL	-1991			
	300 ENDURO	-1991			
	CAPPRA 250	-1991			
	COTA 50	-1991			
	COTA 50 AIR	-1994			
	COTA 50 H2O	-1994			
	COTA 123 C	-1991			
	COTA 125	-1991			
	COTA 200	-1991			
	COTA 242 T	-1991			
	COTA 247	-1991			
	COTA 250	-1991			
	COTA 304	-1991			
	COTA 307	-1991			
	COTA 330	-1991			
	COTA 335	-1991			
	COTA 340	-1991			
	COTA 349	-1991			
	COTA 350	-1991			
	MORINI FRANCO	GIULIETTA 0.	-		ZA-1
		LIM	-		ZA-1P
MOTO GUZZI	65 GT	1984-	IMS-S	NE-B	
	650 NTX	1984-	IMS-SP	NE-6P	
	850 LE MANS	1981-		NE-B	
	850 T3 C.	1981-			
	850 T3-T4	1981-			
	V 35	1982-1984			
	V 35 II	1982-1984			
	V 35 IMOLA	1982-1984			
	V 50	1980-			
	V 50 C	1982-1984			
	V 50 C	1984-			
	V 50 CH.	1982-			
	V 50 II	1982-1990			
	V 50 III	1990-			
	V 50 MONZA	1982-1984			



MARCA BRAND	MODELO MODEL			
MOTO GUZZI	V 50 MONZA	1984-		
	V 50 TS	1982-		
	V 65	-		
	V 65	1984-		
	V 65 C	1984-		
	V 65 FL	1984-		
	V 65 II	1984-		
	V 65 LA	1984-		
	V 65 SP	1984-		
	V 65 TT	1984-		
	V 75	-		
	V 75	1984-		
	125 SX	1980-		NE-B
	125 CUSTOM	1980-		
	125 TT	1980-		
	125 TURISMO	-		NE-B
	150 T3	1980-		NE-6P
	DINGO	-		
	STORNELLO	-		
	125 TURISMO	1981-	IMS-S	NE-B
	254	-	IMS-SP	
	V 35	1984-		
	V 35 C	1984-1986		
	V 35 F.	1984-		
	V 35 II	1984-		
	V 35 III	1984-		
	V 35 IMOLA	1984-		
	V 1000 I LE	1984-		
	V 1000 1000.	1984-		
	V 1000 II L	1984-		
	250 ELECTR.	-	FEM-2D	NE-B
			FEM-2I	
	250 TS	-	FEM-2D	NE-B
250 GTS	-	FEM-2I	NE-6P	
250	1979-	IMS-S	NE-B	
250	-	IMS-SP	NE-6P	
850 TS	1980-			
SP 1000 II	1984-			
V 1000 CALL	1984-			
V 1000 CONV.	1984-			
V 1000 GT	1984-			
V 1000 SP	1984-			
V 1000 SP II	1984-			
250 NEVADA	1984-	ZA-1	ZA-1	
250 NEVADA	1984-	ZA-1P	ZA-1P	
250	1979-	FEM-1D	NE-B	
850 LE MANS	1979-1981	FEM-1I	NE-6P	
850 T3	1979-1980	SIP-3		
850 T3 C.	1979-1981			
V 1000 C.	1979-			
250 NTX	1984-	ZA-1	NE-B	
V 75 NTX	1984-	ZA-1P		
850 GT	1980-	FEM-1D	NE-B	
		FEM-1I	NE-6P	
1000 GT RL	1980-	IMS-S	ZA-1	
1000 GT RH	1980-	IMS-SP	ZA-1P	
1000 LE MANS	1980-			
1000 S	1980-			
1000 ST II	-			



MOTOCICLETA

MOTORCYCLE

MARCA BRAND	MODELO MODEL				
MOTO GUZZI	1988 ST III	-			
	V 35 C	1980-			
	V 35 GT	1980-			
	V 35 NTX	1980-			
	V 35 TT	1980-			
	BREVA	2003-	ZA-9P1	ZA-9P1	
	CALIFOR. EV	2003-			
	V 11	2003-			
	FALSAHARA	-	FEM-10		
	V 7 SPORT	-	SIP-3	NE-6 NE-6P	
	V 1988 GS	1979-	BMS-5 BMS-5P	BMS-4 BMS-5P	
	MOTO MORINI	3 1/2 SPD.	1981-	FEM-10	NE-6
3 1/2 V		1981-	FEM-11	NE-6P	
125 T		1981-			
254		1981-			
254 BFC		1981-			
500 GV		-			
500 KANGEROO		-			
500 T/S		-			
50 CORSARIO		-		NE-6	
125 CORSARIO		-		NE-6P	
254 KANGURO		1979-			
254 STRADA		1979-			
504		1979-			
125 H		1984-	FEM-20	ZA-1	
125 KJ		1984-	FEM-21	ZA-1P	
354 COGUARO		1980-	AF-6D	ZA-1	
354 EXCALIB.		1980-		ZA-1P	
354 KANGURO		1980-			
354 NEW YORK		1980-			
354 XE		1980-			
501 COGUARO		1980-			
501 EXCALIB.		1980-			
501 KANGURO		1980-			
501 NEW YORK		1980-			
500 CAMEL		-	AF-6D	NE-8	
MOTOS (CAN)		125 LT	-	LAS-X	NE-6
		SUPERMOBY 53	-		NE-6P
MOTOSI		254	-	BMS-5 BMS-5P	NE-8
MOTRON		3/TRE-RCV	-		ZA-1
		MST	-		ZA-1P
	8A PL 4P	-			
	SU 2R 10	-			
	TAXI AP	-			
	TAXI ES 10	-			
	COMPACT	1990-1991	ZA-1	ZA-1	
	GL 4	1990-1991	ZA-1P	ZA-1P	
	GTO	1990-1991			
	INVADER	1990-1991			
	SHOPPING	1990-1991			
	TAXI ES 10	1990-1991			
	TAXI KS-SL	1990-1991			
MV AUGUSTA	125 S	-	FEM-11		
	125 SPORT	-		FEM-11	
	350 SPORT	-		FEM-21	
	368 S	-	AF-71	AF-71	

MARCA BRAND	MODELO MODEL			
MV AUGUSTA			AF-71P	AF-71P
	254 S	-	SUZU-13P	NE-6
			SUZU-41 SUZU-41P	NE-6P
MC	TOUR	1994-	ZA-40P	
NORTON	890 COMMANDO	-	UN-3	
OMC	CITY	-		ZA-1
	ELITE	-		ZA-1P
	ELITE SL	-		
	ELS-SL	-		
	EXCLAIM	-		
	HI TECH	-		
	MARINER-SL	-		
	MUDDY	-		
	MUDDY JUNIOR	-		
	WILD ELITE	-		
	WILD MS	-		
WILD TIGRE	-			
OSCA	125	-	CAS-10	NE-6
	254 ENDURO	-		NE-6P
	354 ENDURO	-		
	254 DESERT	-		CL-21
	254 EXPLORER	-		CL-31
	254 FUGO	-		
	254 ORANGE	-		
	254 SUPER	-		
	254 TRIAL	-		
	254 TU	-		
	254 TURISMO	-		
	254 YO	-		
	354 EXPLORER	-		
	354 ORANGE	-		
	354 TRIAL	-		
TRIAL 303	-			
TRIAL JELLOW	-			
PENINSULA	COLORADO	-		ZA-1
	DAY LCRSA	-		ZA-1P
	DAY S SX	-		
	GIULIETTA	-		
	MINI L SAMTK	-		
	OXFORD	-		
	OXFORD ROAD	-		
	TIR	-		
	VAI M03	-		
	VAI R	-		
WILD	-			
PEUGEOT	BUXY	1995-	ZA-1	ZA-1
	FOR LUX	1994-		
	SPEEDAKE	1995-		
	SQUAB	1995-1996		
	SC 50 L SCO.	-	SUZU-13P	SUZU-13P
	SC 80 L SCO.	-	SUZU-41	SUZU-41
	ST 50 L SCO.	-	SUZU-41P	SUZU-41P
	SV 125 SCO.	-		
SQUAB	1997-	NE-65P		
SV 50 GEO	1992-	NE-45	NE-45	
SV 80 GEO	1993-	NE-65P	NE-65P	
SV 125 GEO	1993-			

MARCA BRAND	MODELO MODEL			
PGO	COMET	2000-	PGO-1P	
	PMS	2000-		
	PMX	2000-		
	RODOSHOW	2000-		
	TREX	2000-		
	SCOOTER	-	PGO-1	
PIAGGIO	APE 600 MP	1979-1981	AF-60	
	APE CAR	-	AF-60	FAB-1
	APE CAR P3	-	AF-60P	
	APE CARP 601	-	AF-61	
			AF-61P	
			FEM-10	
			FEM-11	
	APE P 50	-	FEM-10	NE-6
	APE TM P 50	-	FEM-11	NE-6P
	VESPA 50	1979-1980		
	VESPA 50 ES	1981-1983		
	APE TM 703	-	AF-60	FAB-1
	NICA 125	-	AF-60P	
			AF-61	
			AF-61P	
	BOSS 50	1980-	ZA-1	
	BRAVO	1992-	ZA-1P	
	BRAVO 50	1980-		
	CIAO	1992-		
	CIAO 50	1980-		
	GRILLO	1992-		
	GRILLO 50	1980-		
	SI	1992-		
	SI 50	1980-		
	BOXER 50	1982-1986	NE-6	
	BRAVO 50	1982-1986	ZA-1	
	CIAO 50	1982-1986	ZA-1P	
	SI 50	1982-1986		
	COSA 125	1988-	ZA-2P	ZA-2P
	COSA 150	1988-		
	COSA 200	1988-		
	VESPA 50 PK	1980-		
	VESPA FL 2	1980-		
	VESPA FLURL	1980-		
	VESPA RUSH	1980-		
	COSA 125 MA	1992-	FI-1	FI-1
	COSA 150 MA	1992-	FI-1P	FI-1P
	COSA 2 125	1993-	ZA-2P	ZA-2P
	COSA 2 150	1993-		
	COSA 2 200	1993-		
	COSA 200 MA	1992-		
	VESPA 125 E	1984-		
	VESPA P 125	-		
	VESPA P 125	1984-1991		
	VESPA PK 125	-		
VESPA PX 125	1984-1991			
VESPA PX 150	1984-1991			
VESPA PX 200	1984-			
FREE BL	1990-	ZA-7DP		
HEXAGON 125	1990-	ZA-4DP	ZA-4DP	
QUARTZ	1992-	ZA-2P	ZA-2P	
SFERA	1992-	ZA-7DP	ZA-7DP	
VESPA 50	1992-			



MARCA BRAND	MODELO MODEL			
PIAGGIO	ZIP	1992-		
	SCATTO	-1991	ZA-13P	ZA-13P
	TOLEDO-SC	-	CL-21	
			CL-31	
	VESPA 125 E	1980-1984	NE-6	
	VESPA 150	1979-	NE-6P	
	VESPA 150 RA	1979-		
	VESPA 150 SV	1979-		
	VESPA P 80X	-		
	VESPA P 125X	1981-		
	VESPA P 150X	1981-		
	VESPA P 200X	1980-		
	VESPA PX 200	1980-		
	VESPA PX125E	1981-		
	VESPA 125 ET	1979-	FEM-10	ZA-1
VESPA 200 PX	1979-	FEM-11	ZA-1P	
VESPA P 150X	1979-1981			
VESPA 125ET3	-1979	FEM-11	NE-6	
			NE-6P	
VESPA PK 50	1984-1986	FI-1	FI-1	
VESPA PK 105	1984-1986	FI-1P	FI-1P	
MALIBU	CICLI	-	LF-2	
	CYCLES	-	UN-1P	
RICCATO	ATALA	1995-	ZA-40P	
	HACKET AT12	1995-		
	HACKET RACL	1995-		
SUZUKI	50	-1992	BH-4	BH-4
	125	1992-		
SUZUKI	400 ENDURO	1979-	SUZU-13P	
	400 S	1979-	SUZU-41	
	GS 400 T	-	SUZU-41P	
	GT 350	1979-		
	GT 500	1979-		
	GS4 DJEBEL	-1991	SUZU-13P	SUZU-13P
	DR 125 S	-	SUZU-41	SUZU-41
	DR 250 S	1984-	SUZU-41P	SUZU-41P
	DR 400	1980-1985		
	DR 500	1984-1986		
	DR 600	1985-		
	DR 650	1980-1991		
	DR 750 BIG	1980-1991		
	DR 800 SL	1980-		
	GS 125 ES	1984-		
	GS 150	1984-1985		
	GS 850	1980-1982		
	NET 125	-		
	TS 125 S	-		
	TS 125 X	-		
ADDRESS	1992-	SUZU-110	SUZU-110	
ADDRESS 100	1994-	SUZU-110P	SUZU-110P	
DR 350 SE	1984-			
DR 650	1992-			
GS 400	1993-			
GS 500	1989-			
GS 750	1991-			
GSF 400	1993-			
GSF 500 EP	1993-			
GSF 600	1995-			
GSX 600	1989-			



MOTOCICLETA

MOTORCYCLE

MARCA BRAND	MODELO MODEL			
SUZUKI	GSX 750	1989-		
	GSX 1100 S2	1993-		
	GSXR 750	1989-1990		
	GSXR 1100	1990-		
	RF 600 R	1993-		
	RF 900 R	1994-		
	RG 125	1995-		
	RS 650	1991-		
	VS 750	1989-		
	VS 800	1992-		
	VS 1400	1998-		
	VZ 800	1998-		
	AH 50	1991-	YAMA-201	YAMA-201
	CP 50	1991-	YAMA-24P	YAMA-24P
			YAMA-28P	YAMA-28P
	AJ 50 ZZ	1995-	ZA-40P	ZA-40P
	AP 50	1995-		
	AN 125	1995-	YAMA-230P	NE-8
	VS 600 GL	1995-	YAMA-230P	
	VS 800 GL	1995-		
	CC 1	-	SUZU-13P	NE-8
	BV 90	-	SUZU-41	
			SUZU-41P	
	DL 1000	2003-	SUZU-120P	SUZU-120P
	DH 600 RSE	1995-		
	GS 500 F	2004-		
	GS 500 E	1995-		
	GSF 600	1995-		
	GSF BANDIT	2004-		
	GSX 61300	2004-		
	GSXR 750 SP	1995-		
	GSXR 750 W	1995-		
	GSXR 1000	2003-		
	GSXR 1100	1995-		
	GZ 250	2004-		
	LR GSX 600	2004-		
	SV 650 S	2003-		
	SV 1000 S	2003-		
	SV 650	2004-		
	SV 750	2004-		
	VL 800	2004-		
	V-STROM 650	2004-		
	V-STROM 1000	2004-		
	VZ 1000	2004-		
	DH 125 SE	1995-	YAMA-200	NE-8
	LS 650	1995-	YAMA-201	
	VS 1400 GLP	1995-	YAMA-200P	
	DH 250	1997-	YAMA-201	
	DH 250 S	1993-	YAMA-200	NE-8
	DH 250 SM	1992-	YAMA-201	
	DH 250 SN	1992-	YAMA-240P	
	VS 750 J	-	YAMA-240P	
			YAMA-28P	
	G 450 L	1989-	SUZU-5	SUZU-5
	GN 400	1985-	SUZU-5P	SUZU-5P
	GNX 250	1985-1991		
	GR 650	1982-		
	GS 450	1989-		
	GS 500	1984-1990		



MARCA BRAND	MODELO MODEL				
SUZUKI	GS 500	1982-1984			
	GS 750	1982-1987			
	GS 800	1982-1985			
	GSX 250 S	1985-1991			
	GSX 400	1985-			
	GSX 500	1985-			
	GSX 550	1985-			
	GSXR 1100	1991-			
	LS 650	1982-			
	LT 250 A	1985-1991			
	RG 250 R	1985-1991			
	RDV 250	1985-1991			
	GS 1000	1982-1985	SUZU-13P	SUZU-13P	
	GSX 1100	1981-1985	SUZU-41	SUZU-41	
	RG 500	1985-	SUZU-41P	SUZU-41P	
			SUZU-5	SUZU-5	
			SUZU-5P	SUZU-5P	
	GSX 750	1981-1989	SUZU-13P	NE-8	
			SUZU-41	SUZU-13P	
			SUZU-41P	SUZU-41	
			SUZU-5	SUZU-40P	
			SUZU-5P	SUZU-5	
				SUZU-5P	
	GSXR 600	1997-	SUZU-120P		
	GSXR 750	1997-			
	GT 500	1979-	SUZU-31		
	GT 750	1979-			
	INTRADOL 1400	1992-	YAMA-180	NE-8	
	VS 800 GL	1993-1995	YAMA-190P		
			YAMA-191		
			YAMA-191P		
			YAMA-230P		
			YAMA-231P		
			YAMA-29P		
	KATANA	1997-	ZA-40P		
	KATANA R	2004-	ZA-9P1	ZA-9P1	
	VS 750 INT.	1986-	YAMA-180	YAMA-180	
			YAMA-180P	YAMA-180P	
			YAMA-181	YAMA-181	
			YAMA-181P	YAMA-181P	
			YAMA-190	YAMA-190	
			YAMA-190P	YAMA-190P	
			YAMA-191	YAMA-191	
			YAMA-191P	YAMA-191P	
			YAMA-200	YAMA-200	
			YAMA-201	YAMA-201	
			YAMA-201P	YAMA-201P	
			YAMA-220P	YAMA-220P	
			YAMA-221P	YAMA-221P	
			YAMA-230P	YAMA-230P	
			YAMA-231P	YAMA-231P	
			YAMA-240P	YAMA-240P	
			YAMA-241P	YAMA-241P	
			YAMA-26P	YAMA-26P	
			YAMA-29P	YAMA-29P	
	YAMA	124 RZ	-	AF-60	NE-8
		280 GS	-		NE-6P
		EXPLORER 125	-		
		EXPLORER 250	-		

MARCA BRAND	MODELO MODEL			
DWM	GS 125	-		
	GT 125	-		
	GTS 125	-		
	RS 125	-		
	RS 250	-		
	TL 329	-		
	268 XN	-	ZA-1	ZA-1
		ZA-1P	ZA-1P	
	WPM 1	-		NE-6
				NE-6P
TESTI	CRICKET PULL	-		NE-6
				NE-6P
TRIUMPH	AMERICA	2000-	ZA-9P1	
	BONNEVILLE	2000-		
	DAYTONA	2000-		
	ROCKET III	2000-		
	SCRAMBLER	2000-		
	SPEEDMASTER	2000-		
	SPRINT ST	2000-		
	THRUXTON	2000-		
	TIGER	2000-		
	TRIDENT	-	DN-3	NE-6
			NE-6P	
YAMAHA	250 COMPETL	-	YAMA-31	YAMA-31
	400	-	YAMA-141	YAMA-141
	RD 400	-	YAMA-150	YAMA-150
			YAMA-151	YAMA-151
	400 BICLON	-	YAMA-170	YAMA-170
			YAMA-171	YAMA-171
	500	1979-	YAMA-91	YAMA-91
	500 ENDURO	1979-	YAMA-141	YAMA-141
	RD 500	1979-		
	TT 350	1995-		
	600 ACERBIS	1980-	YAMA-140	YAMA-140
	OHV 650	1980-	YAMA-141	YAMA-141
	RD 50 M	-		
	XT 50	-		
	AEROX	1990-	ZA-9P1	ZA-9P1
	BT 1100 BU	2003-		
	MAJESTY 250	2005-		
	NEOS	1998-		
	VERSITY 300	2003-		
	AXIS	1995-	ZA-40P	ZA-40P
	BREEZE	1994-		
	BREEZE	1995-		
	SPY	1990-		
	BL 125 BE	1984-1991	YAMA-180	NE-8
	DT 125 BA	1984-1991	YAMA-180P	
	DT 125 BB	1984-1991	YAMA-181	
	DT 125 CE	1984-1991	YAMA-181P	
	DT 125 R	1984-1990	YAMA-190	
	FZ 400	1984-	YAMA-190P	
	FZR 400	1984-	YAMA-191	
	FZR 600	1984-1992	YAMA-190P	
	RD 350	1984-1991	YAMA-200	
	RD 350 LC	1984-1991	YAMA-201	
RD 500	1984-	YAMA-200P		
RT 125 LL	1984-1991	YAMA-220P		
SCROW 225	1984-1991	YAMA-220P		

MARCA BRAND	MODELO MODEL			
YAMAHA	SR 250	1984-1991	YAMA-230P	
	SR 250 SE	1984-	YAMA-231P	
	SR 250 SP	1984-	YAMA-240P	
	SR 500 G-3	1984-	YAMA-241P	
	SR 600	1984-	YAMA-28P	
	TDR 125	1984-1991	YAMA-29P	
	TDR 250	1984-1991		
	TR 1	1984-		
	TZR 125	1984-1991		
	TZR 250	1984-1991		
	XD 250 LC	1984-		
	XJ 600	1984-		
	XJ 600 SP	1984-		
	XJ 600 TT	1984-		
	XJ 750 NS	1984-		
	XJ 750 SE	1984-		
	XJ 900 F	1984-		
	XJ 900 S	1984-		
	XS 350	1984-1991		
	XS 650	1984-		
	XT 400 SP	1984-		
	XT 500	1984-		
	XT 550	1984-		
	XT 600	1984-1991		
	XT 600 4V	1984-1991		
	XT 600 N	1984-		
	XT 600 TE	1984-1991		
	XT 600 YD	1984-		
	XT 600 Z-ZA	1984-1991		
	XU 500 SE	1984-		
	XV 535	1984-		
	XV 1000 SE	1984-		
	XZ 550 LC-S	1984-		
	YZ 125 LC	1984-1991		
	YZ 250 LC	1984-1991		
	YZ 400	1984-		
BL 125 BE	1991-	YAMA-180	NE-8	
DT 125 BA	1991-	YAMA-180P		
DT 125 BB	1991-	YAMA-181		
DT 125 CE	1991-	YAMA-181P		
DT 125 R	1991-1992	YAMA-190		
RD 350	1991-	YAMA-190P		
RD 350 LC	1991-	YAMA-191		
RT 125 LL	1991-	YAMA-191P		
SCROW 225	1991-	YAMA-200		
SR 250	1991-	YAMA-201		
TDR 125	1991-1992	YAMA-280P		
TDR 250	1991-			
TT 350	1991-1995			
TZR 125 R	1991-1992			
TZR 250	1991-			
XT 600	1991-			
XT 600 4V	1991-			
XT 600 TE	1991-			
XT 600 Z-ZA	1991-			
YZ 125 LC	1991-			
YZ 250 LC	1991-			
CR 50 Z	1992-	YAMA-27	YAMA-27	
CT 50 S	1992-	YAMA-27P	YAMA-27P	

MOTOCICLETA

MOTORCYCLE









MARCA BRAND	MODELO MODEL			
YAMAHA	SCOOTER MIX	1991-		
	CT 50 SS	1995-	YAMA-270P	YAMA-270P
			YAMA-27P	YAMA-27P
	DT 125	-1986	YAMA-30	YAMA-30
	DT 125 LC.	-1986	YAMA-31	YAMA-31
	TX 650	1979-		
	TX 750	1979-		
	DT 125	1992-	YAMA-180	YAMA-180
	DT 125 B	1992-	YAMA-181	YAMA-181
	DT 125 B	1992-	YAMA-190	YAMA-190
	DT 125 Z	1992-	YAMA-191	YAMA-191
	TT 600	1992-	YAMA-200	YAMA-200
	TT 600 S	1991-	YAMA-201	YAMA-201
	TZR 125 B	1992-	YAMA-220P	YAMA-220P
	TZR 125 RS/P	1992-	YAMA-220P	YAMA-220P
	XT 600 A	1992-	YAMA-230P	YAMA-230P
	XT 600 E	1991-	YAMA-230P	YAMA-230P
	XT 600 ZA	1991-1992	YAMA-240P	YAMA-240P
			YAMA-240P	YAMA-240P
			YAMA-250P	YAMA-250P
			YAMA-250P	YAMA-250P
	DT 125 CO.	1986-1992	ZA-1	ZA-1
	DT 125 LC.	1986-1992	ZA-1P	ZA-1P
	DT 125 B	1986-1991		
	DT 250	-	YAMA-140	YAMA-140
	DT 250 MX	-	YAMA-141	YAMA-141
	RD 250	-	YAMA-150	YAMA-150
			YAMA-151	YAMA-151
			YAMA-30	YAMA-30
			YAMA-31	YAMA-31
	FJ 1100	1984-	YAMA-211	YAMA-211
	FJ 1200	1984-	YAMA-210P	YAMA-210P
	FS 1200	1984-		
	FZ 600	1984-		
	FZ 600 GE.	1984-		
	FZ 750 A-B	1984-		
	FZR 600	1992-		
	FZR 1000	1984-		
	FZR 1000 L.	1984-		
	FZX 750	1984-		
	GENESIS FZR	1992-		
	RD 500 YP.	1984-		
	SUPER T. 750	1992-		
	TDM 850	1991-		
	TT 350	1984-1991		
TT 600 S	1984-1991			
V MAX 80	1984-			
VMX 12 N	1984-			
XJ 400	1984-			
XJ 600 N	1984-			
XJ 650 T	1984-			
XJ 650 TL.	1984-			
XJ 750 N	1984-			
XJ 750 S.	1984-			
XTZ 750	1984-			
XTZ 750 T.	1984-			
XV 600 SE	1984-			
XV 750 SE	1984-			

MARCA BRAND	MODELO MODEL			
YAMAHA	XV 1000 V.	1984-		
	XV 1100	1984-		
	XZV 12 T	1984-		
	XZV 12 TD	1984-		
	XZV 13 TD	1984-		
	FRZ 600	1995-	YAMA-26	YAMA-26
	FRZ 600 B	1994-	YAMA-26D	YAMA-26D
	GTS 1000	1992-	YAMA-260P	YAMA-260P
	GTS 1000 ABS	1992-	YAMA-26P	YAMA-26P
	TDM	1990-		
	TDM 850	1995-		
	TRX 850	1995-		
	XJ 600 E	1995-		
	XJ 600 S D.	1995-		
	XJ 900 S D.	1995-		
	XT 500	1979-1984		
	XT 600 E	1995-		
	XTZ 600	1994-		
	XVS 110 D.S.	1998-		
	XVS 650	1998-		
	XVZ 1300	1998-		
	YP 250 MAJES	1998-		
	YZF 600	1998-		
	YZF 750 B	1992-		
	YZF 750 SP	1992-		
	YZF 1000	1998-		
	FS 1	-1986	YAMA-160	YAMA-160
	RD 125	-1986	YAMA-161	YAMA-161
			YAMA-30	YAMA-30
			YAMA-31	YAMA-31
	FZX 600 B	1994-	YAMA-190	YAMA-190
	TW 200	1994-	YAMA-190P	YAMA-190P
	FZX 600 B	1995-	YAMA-191	NE-B
			YAMA-231P	YAMA-26
			YAMA-26	YAMA-26D
			YAMA-26D	YAMA-260P
			YAMA-260P	YAMA-26P
			YAMA-26P	
			YAMA-29P	
	FZX 750	1995-	YAMA-180	NE-B
			YAMA-220P	
	RD 350	-	YAMA-3D	YAMA-3D
	XS 500 B	1979-	YAMA-31	YAMA-31
			YAMA-9D	YAMA-9D
			YAMA-91	YAMA-91
RD 500 LC	1984-	YAMA-18D	NE-B	
XJ 500	1984-	YAMA-180P	YAMA-211	
XS 400	1984-	YAMA-181	YAMA-210P	
		YAMA-181P		
		YAMA-190		
		YAMA-190P		
		YAMA-191		
		YAMA-200P		
		YAMA-200		
		YAMA-201		
		YAMA-201P		
		YAMA-211		

MARCA BRAND	MODELO MODEL			
YAMAHA			YAMA-21P	
			YAMA-220P	
			YAMA-220P	
			YAMA-230P	
			YAMA-230P	
			YAMA-240P	
			YAMA-240P	
			YAMA-240P	
			YAMA-240P	
			YAMA-250P	
			YAMA-250P	
	RS 125 C.	-1980	YAMA-50	YAMA-10
			YAMA-51	YAMA-11
	SR 500 G	1979-1984	YAMA-140	NE-8
	SR 500 S	1979-1984		
	XT 500	1979-1984		
	TDR 125	1992-	YAMA-180	ZA-1
	TDR 125 B	1992-	YAMA-180P	ZA-1P
	TDR 125 B	1990-1991	YAMA-190	ZA-1
			YAMA-190P	ZA-1P
	TT 600	1994-	YAMA-200	YAMA-210
	TT 600 E	1994-		
	XT 600 A	1994-		
	XT 600 E	1994-		
	TT 600	1995-	YAMA-200	YAMA-200
	XT 600 A	1995-	YAMA-240P	YAMA-240P
	XT 600 E	1995-	YAMA-280P	YAMA-280P
	TW 200	1995-	YAMA-190	NE-8
			YAMA-230P	
			YAMA-290P	
	XC 125 CYGN.	1995-	YAMA-180	YAMA-180
			YAMA-220P	YAMA-220P
	XS 500	1979-	YAMA-130	YAMA-130
	XS 500 EW	1985-	YAMA-130	YAMA-130
	XS 250	1979-	YAMA-130	YAMA-130
	XS 1100	1984-	YAMA-130	NE-8
	XS 1100 S	1984-	YAMA-130	
	XT 250	1990-	YAMA-170	NE-8
	YPUS 125	1990-		
	XT 400	-	YAMA-140	NE-8
YSR 50	1990-	YAMA-180	NE-8	
		YAMA-180		
		YAMA-220P		
		YAMA-220P		



THE KEY TO EXCELLENCE
GLOBALLY UNLOCKING MILLIONS OF USERS DAILY

REFERENCIA REFERENCE	TIPO TYPE	REFERENCIA REFERENCE	TIPO TYPE	REFERENCIA REFERENCE	TIPO TYPE
YA-111 YA-27 YA-27D	CARAVANA CARAVANS	BH-1 BH-1P BH-2 BH-3 BH-4 BH-5 BH-6 CAT-1P CAT-2 CAT-3 DAE-5P DAY-1 DAY-1P FA-1 MERI-1D MERI-1DP PRE-11 TEU-1 TOYO-27	ESCAVADORA EARTH MOVING MACHINE 	WST-2D YA-11D YA-111 YA-27 YA-27D YA-37 YA-37D YA-4D YA-8	MOTOR MARINO BOAT ENGINES 
AF-8D AF-8DP AF-81 AF-81P AF-9D AF-9DP AF-91 AF-91P BH-1 BH-1P BH-2 BH-3 BH-4 BH-5 BH-6 DAE-5P DAY-1 DAY-1P FA-1 MERI-1D MERI-1DP PRE-11 TEU-1 TOYO-27	CARRIOLA ELEVADORA FORKLIFT 	BH-1 BH-1P BH-2 BH-3 BH-4 BH-5 BH-6 CAT-1P CAT-2 CAT-3 DAE-5P DAY-1 DAY-1P FA-1 MERI-1D MERI-1DP PRE-11 TEU-1 TOYO-27	MOTOR MARINO BOAT ENGINES 	AF-19 AF-19P AF-21 AF-21P AF-5D AF-51 AF-6D AF-61 BL-2 BL-3 BL-4 BL-4D ECB-1 FAB-1 FAB-1D FAB-11 FAB-2D FAB-21 GU-1 GU-1D GU-2 GU-2D IMS-13 IMS-13P IMS-3 IMS-3P IMS-5 IMS-5P RO-51 SI-1D SI-2D SI-3 SI-3D SI-4D VO-1 ZA-4DP	PORTA ESCOPIA SKI HOLDER 
AF-8D AF-8DP AF-81 AF-81P AF-9D AF-9DP AF-91 AF-91P BH-1 BH-1P BH-2 BH-3 BH-4 BH-5 BH-6 DAE-5P DAY-1 DAY-1P FA-1 MERI-1D MERI-1DP PRE-11 TEU-1 TOYO-27	CORTA CÉSPED LAWN MOWER 	BH-1 BH-1P BH-2 BH-3 BH-4 BH-5 BH-6 CAT-1P CAT-2 CAT-3 DAE-5P DAY-1 DAY-1P FA-1 MERI-1D MERI-1DP PRE-11 TEU-1 TOYO-27	ESCAVADORA EARTH MOVING MACHINE 	AB-61 AB-71 AB-81 AF-19 AF-19P AF-21 AF-21P AF-5D AF-51 AF-6D AF-61 BL-5 BL-5D CAM-1D	TAPON DE GASOLINA PETROL CAP 

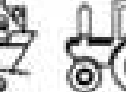

REFERENCIA REFERENCE	TIPO TYPE
-------------------------	--------------

CLI-10	TAPÓN DE GASOLINA PETROL CAP
DAB-1	
FAB-1	
FAB-2	
FAB-10	
FAB-11	
FAB-20	
FAB-21	
FAB-3	
FAB-30	
FAB-40	
FA-2	
GAS-1	
GAS-10	
GGB-10	
GGB-10P	
GGB-21	
GGB-21P	
HA-10	
HA-11	
HU-P	
IMS-13	
IMS-13P	
IMS-3	
IMS-3P	
IMS-5	
IMS-5P	
LAS-1H	
LAS-8	
LAS-Y	
LAS-X	
LAS-Y	
NE-21P	
FJ-1	
FJ-2	
FJ-2P	
FJ-3	
FJ-K	
FJ-KP	
SI-10	
SI-20	
SI-3	
SI-30	
SI-4	
SI-40	
SI-50	
YO-1	
YO-60	
WAS-1	
WAS-3	
WAS-3P	
WAS-4	
WAS-4P	
WAS-5	
WAS-5P	
WAS-6	
WAS-6P	
WAS-8	
WAS-80	



REFERENCIA REFERENCE	TIPO TYPE
-------------------------	--------------

AF-80	TRACTOR TRACTOR
AF-80P	
AF-81	
AF-81P	
AF-90	
AF-90P	
AF-91	
AF-91P	
BH-1	
BH-1P	
BH-2	
BH-3	
BH-4	
BH-5	
BH-6	
CAT-1P	
DAE-5P	
DAV-1	
DAV-1P	
FA-1	
MER-10	
MER-10P	
PRE-11	
TIU-1	
TOYO-27	



JMA HEADQUARTERS
ALEJANDRO ALTUNA, S.A.
Tel +34 943 79 30 00
Fax +34 943 79 72 43
Bidekurtzeta, 6
P.O.Box - Apdo. 70
20500 Arrasate - Mondragón
Gipuzkoa - SPAIN

www.jma.es
ventas@jma.es

JMA POLSKA
JMA POLSKA Sp. z o.o.
Tel +48 42 635 12 80
Fax +48 42 635 12 85
91-342 Kódz ul. Zbąszyńska 3

www.jmapolska.pl
biuro@jmapolska.pl

JMA FRANCE
JMA FRANCE
Tel +33 01 39 22 42 10
Fax +33 01 39 22 42 11
Technoparc
13, rue Edouard Jeanneret
F-78306 Poissy Cedex

www.jmafrance.fr
service.commercial@jmafrance.fr

JMA PORTUGAL
ALTUNA PORTUGAL
COMERCIO DE CHAVES UNIPessoal, LDA.
Tel +35 121 994 7470
Fax +35 121 994 7471
Urbanização dos Areiros, Lote 67 C/v
2895-733 São João da Talha

www.jmaportugal.com
altuna.portugal@mail.telepac.pt

JMA UK
SKS LTD
Tel +44 144 229 1400
Fax +44 144 286 3683
Unit 2, Canalside
Northbridge Road
Berkhamsted
Herts HP4 1EG

www.skskeys.co.uk
sales@skskeys.co.uk

JMA INDIA
JMA KEYS INDIA PVT. LTD
Tel: +91 124 427 5482
H-239 & H240 Sushant Shopping Arcade
Sunshant Lok-I, Block B
122002 Gurgaon
Haryana

www.jmakeys.in
info@jmakeys.in

JMA USA
ALTUNA GROUP USA INC.
Tel +1 817.385.0515
Fax +1 817.385.4850
1513 Greenview Drive
75050 Grand Prairie, Texas

www.jmausa.com
info@jmausa.com

JMA MEXICO
LLAVES ALTUNA DE MEXICO S.A de C.V
Tel +52-33-3777-1600
Fax +52-33-3777-1690
Av. Aviación No. 5520
Col. San Juan de Ocotán
C.P. 45019 Zapopan, Jalisco

www.jma.com.mx
ventas@jma.com.mx

JMA ARGENTINA
JMA ARGENTINA S.A.
Tel +54-3461 462 422
Fax +54-3461 462 422
Av. Central Acero Argentino Oeste 678
Parque industrial COMIRSA
2900 San Nicolas (Prov. Buenos Aires)

www.jma-argentina.com.ar
info@jma-argentina.com.ar

JMA MAROC
JMA MAROC S.A.R.L.
83,85 Bd Oued Ziz
El Oulfa
Casablanca
Marruecos
Tel. 00212 656 195 195

www.jma.ma

EL LIDER EN TECNOLOGÍA
THE LEADER IN TECHNOLOGY

EL LIDER EN CALIDAD
THE LEADER IN QUALITY

**EL LIDER EN COMPROMISO
MEDIOAMBIENTAL**
THE LEADER IN THE
COMMITMENT TO THE
ENVIRONMENT

EL LIDER EN SERVICIO
THE LEADER IN SERVICE

**ABRIENDO MILLONES DE PUERTAS
EN TODO EL MUNDO CADA DÍA**

*GLOBALLY UNLOCKING
MILLIONS OF DOORS DAILY*

A4-A5 **Aviso Legal**

Mezu Legala
Legal Warning
Informations Légales
Rechtliche Hinweise

A6-A7 **JMA es Compromiso**

JMA Konpromisoa da
JMA is Commitment
JMA, l'engagement
JMA bedeutet Verpflichtung

A8-A9 **JMA, el Lider**

JMA, Liderra
JMA, the Leader
JMA, le Leader
JMA der Markführer

A10-A11 **JMA, en el Mundo**

JMA, Munduan
JMA Worldwide
JMA dans le Monde
JMA in der Welt

A12-A13 **Descripción y Terminología**

Deskribapen eta Terminologia
Description and Terminology
Description et Terminologie
Begriffserklärung und Terminologie

A14-A15 **Símbolos y Nacionalidades**

Ikur eta Nazionalitateak
Symbols and Nationalities
Symboles et Nationalités
Symbole und Nationalitäten

A16-26 **LLAVES**

GILTZAK
KEYS
CLÉS
SCHLÜSSEL

A17- A20 **Indice General**

Aurkibidea
General Index
Index Generale
Gesamtverzeichnis

A21-A22 **Indice de Marcas**

Marken Aurkibidea
Brand Index
Index Marque
Hauptmarke

1 - 26 **Imágenes de Llaves**

Giltzen Irudiak
Keys Images
Images Clés
Schlüssel Bilder

27 - 70 **CAT. ESPECIALISTA DE MÁQUINAS DUPLICADORAS**

KOPIATZEKO MAKINEN GIDA ESPEZIALISTA
KEY CUTTING SPECIALIST'S GUIDE
SPÉCIALISTE CATALOGUE DE MACHINES DUPLICATRICES
SPEZIALISTKATALOG

29 - 33 **Fresas**

Fresak
Miling Cutters
Fraises
Fräse

35 - 70 **Imágenes de Llaves**

Giltzen Irudiak
Keys Images
Images Clés
Schlüssel Bilder

ESPAÑOL

SUPLEMENTO 2011.C10

Las llaves que aparecen en este catálogo son piezas JMA fabricadas por Alejandro ALTUNA S.A. o un subcontratista de éste. Están diseñadas para cilindros y cerraduras de los fabricantes cuyas marcas se indican en este catálogo.

Conforme a las disposiciones legales vigentes relativas a la propiedad industrial, las marcas o nombres comerciales indicados en este catálogo son propiedad exclusiva de los fabricantes de cilindros y cerraduras, así como de los fabricantes de automóviles, otros constructores, distribuidores y usuarios.

Dichas marcas o nombres comerciales se indican en calidad simplemente informativa con el fin de reco-

nocer con rapidez la cerradura a la que corresponden nuestras piezas.

Este catálogo está reservado exclusivamente a profesionales de la reproducción de llaves que utilizan piezas JMA.

Los datos referentes a los productos de este catálogo tienen carácter indicativo. Manteniendo siempre las características básicas, nos reservamos el derecho de realizar, sin previo aviso, modificaciones técnicas, estéticas o de otro tipo, por razones de evolución de los productos en cuestión.

Algunos modelos que están en este nuevo catálogo podrán recibirlos tanto con la marca y la referencia JMA como con otra marca del grupo ALTUNA.

EUSKERA

SUPL. 2011.C10

Katalogo honetan ageri diren giltzak Alejandro ALTUNA SA enpresak edo honek kontratatutako beste enpresa batek egindako JMA piezak dira. Katalogoan zehazten diren marken fabrikatzaileen zilindro eta sarrailetarako diseinatuta daude.

Jabetza industrialari buruz indarrean dauden legezadapenekin bat etorri, katalogo honetan zehaztutako merkataritza-markak edo izenak zilindro eta sarrailen fabrikatzaileen nahiz ibilgailuen fabrikatzaileen eta beste eraikitzaile, banatzaile eta erabiltzaile batzuen jabetza eskusibokoak dira.

Merkataritza-marka edo izen horiek zehaztasun gehiago emateko adierazten dira, gure piezak zein sarrailari dagozkion berehala ikusi ahal izateko.

Katalogo hau giltzen kopiak egiteko JMA piezak erabiltzen dituzten profesionalentzako da soilik. Katalogo honetako produktuei buruzko datuek izaera adierazgarria dute. Oinarritzko ezaugarriak gordez, produktuen bilakaeraren ondoriozko aldaketa teknikoak, estetikoak edo bestelakoak egiteko eskubidea dugu, aurretik horren berri eman beharrik gabe.

Katalogo berri honetan dauden eredueta batzuk JMA marka eta erreferentziarekin nahiz ALTUNA taldeko beste marka batekin jaso ahal izango dira.

ENGLISH

SUPL. 2011.C10

The keys that appear in this catalogue are JMA parts manufactured by Alejandro ALTUNA S.A. or one of its subcontractors. They are designed for cylinders and locks made by the manufacturers whose trademarks are indicated in this catalogue.

In accordance with legal requirements relating to industrial property rights, the trademarks or trade names indicated in this catalogue are the exclusive property of the manufacturers of the cylinders and locks, as well as automobile manufacturers, other constructors, distributors and users.

The aforementioned trademarks or trade names are indicated simply for information purposes so that the lock to which our parts correspond can be recognised quickly and easily.

This catalogue is for the exclusive use of professional key copiers who use JMA parts.

Data referring to the products in this catalogue are indicative in nature. Although the basic characteristics are maintained at all times, we reserve the right to make, without previous notice, any technical, aesthetic or other types of changes involved in the development of the products in question.

Some of the keys in this new catalogue could be received either with the JMA reference and trademark or with another trademark from the ALTUNA group.

FRANÇAIS

SUPL. 2011.C10

Les ébauches de clés reportées sur ce catalogue sont des ébauches JMA fabriquées par Alejandro ALTUNA S.A. ou un de ses sous-traitants Elles sont destinées aux cylindres et serrures des fabricants dont les marques sont indiquées dans ce catalogue.

Conformément aux dispositions légales en vigueur relatives à la propriété industrielle, les marques ou les dénominations commerciales citées dans ce catalogue sont la propriété exclusive des fabricants de cylindres et de serrures ainsi que des constructeurs de voitures, autres constructeurs, distributeurs et utilisateurs.

Ces marques ou dénominations commerciales sont indiquées à titre de simple information afin de connaître rapidement à quelle serrure nos ébauches sont destinées.

Ce catalogue est exclusivement réservé aux professionnels de la reproduction de clés, utilisant des ébauches JMA. Les renseignements sur les produits de ce catalogue sont donnés à titre indicatif. Tout en gardant les caractéristiques de base, nous nous réservons le droit d'apporter, sans préavis, des modifications techniques, esthétiques ou autres, dues à l'évolution des produits en question.

Des ébauches de, cet catalogue pourront être livrées soit avec la marque et référence JMA soit avec une autre marque du groupe ALTUNA.

DEUTSCH

SUPL. 2011.C10

Die in dem vorliegenden Katalog aufgeführten Schlüssel sind JMA-Teile, die von der Firma Alejandro ALTUNA, S.A., einem Zulieferanten von JMA, hergestellt werden. Sie sind für Zylinder und Schlösser derjenigen Hersteller entwickelt worden, deren Marken in diesem Katalog aufgeführt sind.

In Übereinstimmung mit den geltenden gesetzlichen Vorschriften bezüglich des gewerblichen Eigentums sind die im vorliegenden Katalog aufgeführten Marken und Firmennamen ausschließliches Eigentum der Zylinder- und Schloßhersteller, sowie der Automobilhersteller und anderer Konstrukteure, Vertreiber und Benutzer.

Diese Marken und Firmennamen werden nur zu Informationszwecken aufgeführt, mit dem Ziel, auf schnelle Weise zu erkennen, zu welchem Schloß unsere Teile gehören.

Dieser Katalog ist ausschließlich für Fachleute des Bereichs der Schlüsselreproduktion gedacht, die JMA-Teile verwenden.

Die Daten bezüglich der Produkte des vorliegenden Katalogs haben informativen Charakter. Bei Aufrechterhaltung der grundlegenden Eigenschaften behalten wir uns das Recht

vor, aus Gründen der Entwicklung der entsprechenden Produkte und ohne Vorankündigung technische, ästhetische oder andere Änderungen vorzunehmen.

Einige Modelle des neuen Katalogs können Sie sowohl mit der Marke und der Bezeichnung JMA erhalten, als auch mit jeder anderen Marke der Gruppe ALTUNA.

THE KEY TO EXCELLENCE
GLOBALLY UNLOCKING MILLIONS OF DOORS DAILY



ESPAÑOL

NUESTRO ÉXITO ESTÁ BASADO EN EL COMPROMISO DE LAS PERSONAS

Alejandro Altuna S.A. es la sociedad matriz e impulsora de Altuna Group. Fabrica todo tipo de **llaves para cerradura** así como **máquinas duplicadoras**. Sus productos van destinados al mercado **OEM** y a la reposición, en este caso con la marca **JMA**.

Fundada por el Sr. Alejandro Altuna en 1942 arrancó su actividad en Mondragón. En poco tiempo, una nueva generación familiar que apostó por el desarrollo y la inversión impulsó a la empresa a un importante crecimiento que consolidó a la marca **JMA** hacia los 60 como líder indiscutible del país.

Posteriormente, la estrategia de apertura de mercados exteriores apoyada en la internacionalización y siempre basada en un enfoque innovador de los procesos industriales, ha convertido a **ALTUNA GROUP** en el **primer productor de llaves europeo y referente mundial** en este campo.

Actualmente, 13 compañías en 4 continentes trabajan conjuntamente para el desarrollo y potenciación de la fuerza de nuestra marca JMA, conocida en más de 100 países en todo el mundo.

JMA integra equipos de **personas comprometidas** y motivadas por un proyecto común que nos ha permitido ser el mayor fabricante de llaves de Europa.

EUSKERA

GURE ARRAKASTA PERTSONEN KONPROMISOAN DATZA

Alejandro Altuna S.A. Altuna Groupen sozietate matrizea eta sustatzailea da. **Sarrailarako era guztietako giltzak** eta **kopiak egiteko makinak** ekoizten ditu. Bere produktuek **OEM** merkaturak eta birjarpena dute helburu, eta, kasu horretan, **JMA** markaz merkaturatzen dira.

Enpresa Alejandro Altuna jaunak sortu zuen 1942an, eta Arrasaten hasi zen lanean. Handik gutxira, familiako belaunaldi berriak garapenaren zein inbertsioaren alde egin zuen, eta enpresa bera ikaragarri hazi zen. Hori dela eta, 60ko hamarkadan, **JMA** marka herrialdeko lider eztaba da.

Ondoren, kanpoko merkaturak irekitzeko estrategia nazioarteko bihurtzeko prozesuan oinarritu da, eta, beti-beti, industria-prozesuen ikuspegi berritzailea hartu du kontuan. Horren ondorioz, **ALTUNA GROUP** **lehen giltzagilea da Europan**, baita arlo horretako **munduko erreferentea** ere.

Gaur egun, 13 konpainiak 4 kontinentetan lan egiten dute elkarrekin, mundu zabaleko 100etik gora herrialdetan ezaguna den **JMA** markaren indarra garatzeko eta sustatzeko.

JMAko taldeetan **persona konprometituak** eta motibatuak daude, eta proiektu bateratua dute. Horri esker, Europako enpresa giltzagile handiena da.

ENGLISH

OUR SUCCESS IS BASED ON OUR PEOPLE'S COMMITMENT

Alejandro Altuna S.A. is the parent company and driving force behind the Altuna Group. It manufactures all types of **lock-keys and key-cutting machines**. Its products are for the **OEM** and replacement markets, in the latter case with the **JMA** brand.

Set up by Alejandro Altuna in 1942, it started the production in Mondragón (Spain). In a short time, a new generation of the family committed to development and investment saw the company through significant growth which consolidated the **JMA** brand in the 60's as the indisputable leader in Spain.

Later, the strategy of opening up to foreign markets backed by globalisation and always based on an innovative attitude towards industrial processes, turned the **ALTUNA GROUP** into the **largest producer of keys in Europe and a benchmark worldwide** in the field.

Currently 13 companies in four continents work together to develop the strength of our **JMA** brand, well known in more than 100 countries all over the world.

This successful trail has led us to become the biggest key producer in Europe based on **our people's commitment**.

JMA ES COMPROMISO

JMA IS COMMITMENT



FRANÇAIS

NOTRE SUCCÈS EST FONDÉ SUR L'ENGAGEMENT DES PERSONNES

*Alejandro Altuna S.A. est la société-mère qui a donné lieu au Groupe Altuna. Elle fabrique toutes sortes de **clés de serrure et de machines à copier**. Ses produits sont destinés au marché **OEM** et au remplacement, dans ce cas sous la marque **JMA**.*

*Alejandro Altuna en 1942, elle s'est établie à Mondragón. Très vite, une nouvelle génération familiale a misé sur le développement et grâce aux investissements engagés, l'entreprise a connu une forte croissance qui, dans les années 60, a imposé la marque **JMA** à la tête du secteur.*

*Par la suite, la stratégie d'ouverture sur les marchés extérieurs et une volonté d'internationalisation toujours sous-tendue par le recours aux procédés industriels les plus novateurs, a fait du **GROUPE ALTUNA** le **premier producteur de clés européen** et un **réfèrent mondial** dans ce domaine.*

Actuellement, 13 firmes sur 4 continents unissent leurs forces pour dynamiser et faire progresser notre marque JMA, connue dans plus de 100 pays du monde entier.

*Les équipes JMA sont formées de **personnes motivées et pleinement investies** dans un projet commun qui nous a permis de devenir le plus important fabricant de clés d'Europe.*

DEUTSCH

UNSER ERFOLG BASIERT AUF DAS ENGAGEMENT VON MENSCHEN

*Alejandro Altuna S.A. ist die Muttergesellschaft, aus der später die Altuna Group hervorging. Sie stellt **Schlüssel** aller Art sowie **Schlüsselkopiermaschinen** her. Ihre Produkte wenden sich an dem OEM- und den Ersatzschlüsselmarkt, in diesem Fall mit der Markenbezeichnung **JMA**.*

*Das Unternehmen wurde 1942 von Alejandro Altuna gegründet und begann seinen Werdegang in Mondragón. Innerhalb eines nur kurzen Zeitraums sorgte eine neue, auf Entwicklung und Investition setzende Familiengeneration für ein bedeutendes Wachstum und sicherte der Marke **JMA** damit Anfang der 60er Jahre die unbestreitbare Führungsposition im Land.*

*Später dann hat die auf das Konzept der Internationalisierung und der Innovation der industriellen Prozesse gestützte Strategie der Öffnung gegenüber ausländischen Märkten die **ALTUNA GROUP** zum **führenden europäischen Hersteller von Schlüsseln und einem weltweiten Bezugspunkt** für diesen Sektor werden lassen.*

Derzeit arbeiten 13 Unternehmen in 4 Kontinenten gemeinsam, um die Stärke der in über 100 Ländern der ganzen Welt bekannten Marke JMA zu potenzieren und weiterzuentwickeln.

*JMA arbeitet mit Teams **engagierter und motivierter Menschen**, die sich für ein gemeinsames Projekt einsetzen, das es uns möglich gemacht hat, der größte Hersteller von Schlüsseln in Europa zu werden.*

ESPAÑOL:

LIDER EN TECNOLOGÍA:

Una apuesta sólida por la calidad y la innovación basada en la automatización y garantía de procesos y soportada por una vocación inversora a largo plazo.

LIDER EN CALIDAD:

En el ámbito de la Calidad Alejandro Altuna S.A. siempre ha sido una empresa líder y pionera en su sector. Nuestra política de calidad se basa en la prevención y planificación, mejora continua, satisfacción del cliente y participación de las personas

Estos valores están impregnados en nuestra empresa desde sus orígenes y han sido, junto con una adecuada política de inversión en instalaciones y maquinaria, el motivo principal de nuestro éxito, que además nos permite asegurar la competitividad de la empresa y con ello el futuro a largo plazo.

Además de la Certificación en Calidad de acuerdo a la ISO 9001, Alejandro Altuna S.A. acoge Sistemas de Gestión de la Calidad homologados por las empresas líderes del sector de automoción y residencial. Actualmente nuestra empresa es reconocida en el mercado como líder en este campo.

LIDER EN EL COMPROMISO POR EL MEDIO AMBIENTE:

En Alejandro Altuna S.A. las buenas prácticas medioambientales son la norma y no la excepción. Nuestro equipo forma parte de un proyecto de empresa respetuoso con el medioambiente y que colabora con el desarrollo sostenible de nuestro entorno.

Alejandro Altuna S.A. fue el primer fabricante mundial de llaves en conseguir en 2000 el certificado ISO 14001 para su Sistema de Gestión. Este Sistema incorpora la política medioambiental, donde se recogen los valores y compromisos de la empresa, así como procedimientos que desarrollan los sistemas de trabajo y garantizan las correctas prácticas medioambientales en todos los ámbitos de la empresa.

LIDER EN SERVICIO:

La realidad de una empresa se demuestra en su capacidad por responder con la máxima celeridad y eficacia a las necesidades y exigencias de los clientes. Se encuentran donde se encuentren. JMA pone a su disposición 5 plantas productivas en localizaciones estratégicas. Además, gracias a su amplia red de filiales y empresas distribuidoras repartidas por todo el mundo, le permite llegar a cualquier cliente, se cual sea su ubicación.



EUSKERA:

LIDERRA TEKNOLOGIAN:

Kalitatearen eta berrikuntzaren aldeko apustua sendoa da, prozesuen automatizazioan nahiz bermean oinarrituta eta epe luzearako inbertsioa eginda.

LIDERRA KALITATEAN:

Kalitatearen arloan, Alejandro Altuna S.A. sektoreko enpresa liderra eta aitzindaria izan da beti. Hona hemen gure kalitate-politikaren oinarriak: prebentzioa, plangintza, etengabeko hobekuntza, bezeroaren poztasuna eta pertsonen partaidetza.

Balio horiek hasiera-hasieratik ezarri dira gure enpresan, eta, instalazio zein makinetan inbertitzeko politika egokiarekin batera, gure arrakastaren arazo nagusia izan dira. Horrez gain, enpresaren lehiakortasuna eta epe luzearako etorkizuna bermatzeko aukera ere eskaini digute.

ISO 9001en arabera kalitate-ziurtagiria ez ezik, Alejandro Altuna S.A. enpresak ibilgailu-industriako eta bizileku-sektoreko enpresa liderrek homologatutako kalitate-kudeaketarako sistemak ere baditu. Gaur egun, merkatuaren arabera, gure enpresa liderra da arlo horretan.

LIDERRA INGURUMENAREKIKO KONPROMISOAN:

Alejandro Altuna S.A. enpresan, ingurumen-arloko jardura egokiak ez dira salbuespena, araua baizik. Gure taldea ingurumena errespetatu eta ingurunearen garapen iraunkorra sustatzen duen enpresa-proiektuaren barruan dago.

2000. urtean, Alejandro Altuna S.A. bere kudeaketa-sistemarako ISO 14001 ziurtagiria lortu zuen lehen giltzagilea izan zen munduan. Ingurumen-politika sistema horren barruan dago kokatuta, eta, bertan, enpresaren balioak zein konpromisoak azaltzen dira, baita lan-sistemak garatu eta enpresako arlo guztietan ingurumen-jardura egokiak bermatzeko prozedurak ere.

LIDERRA ZERBITZUAN:

Edonon daudela ere, bezeroen premiei eta eskakizunei ahalik eta azkarren eta era eraginkorrean erantzuteko daukan gaitasuna da enpresaren errealitatea-ren adierazgarri.

JMAk 5 ekoizpen-lantegi ditu leku estrategikoetan. Gainera, bere filialen sarea zabala denez eta banaketa-enpresak mundu zabalean barreiatuta daudenez, edozein bezeroarengana heldu daiteke, edonon dagoela ere.

JMA, EL LIDER

JMA, THE LEADER

ENGLISH:

THE LEADER IN TECHNOLOGY:

Looking for the latest developments to improve the production processes together with a strong investment policy in all our plants to ensure the company's competitiveness and long-term future.

THE LEADER IN QUALITY:

As far as Quality is concerned, Alejandro Altuna S.A. has always been a leading, pioneering company in its sector. Our quality policy is based on prevention and planning, continuous improvement, customer satisfaction and people participation.

These values have been impregnated in our company from the start and have been, together with a good investment policy in terms of equipment and machinery, the main reason behind our success, which moreover enables us to ensure the company's competitiveness and long-term future.

In addition to Quality Certification to ISO 9001, Alejandro Altuna S.A. operates Quality Management Systems approved by the leading companies in the automotive and residential sectors. Our company is currently recognised in the market as a leader in this field.

THE LEADER IN THE COMMITMENT TO THE ENVIRONMENT:

At Alejandro Altuna S.A. best environmental practice is the norm and not the exception. Our team is part of a business project that respects the environment and contributes to the sustainable development of our community.

Alejandro Altuna S.A. was the first key manufacturer in the world to achieve ISO 14001 certification for its management system in 2000. This system incorporates the environmental policy, which includes the company's values and commitments, as well as procedures to set out the work systems and ensure good environmental practice throughout the company.

THE LEADER IN SERVICE:

The efficiency of a company is shown in its capacity to respond with the maximum speed and effectiveness to the needs and requirements of its customers, wherever they are based.

JMA places at your disposal 5 production plants based in strategic locations. Moreover, with its extensive network of associate and distribution companies located throughout the world, the company can reach any customer, wherever based.

FRANÇAIS:

LEADER EN TECHNOLOGIE:

Un pari résolu sur la qualité et l'innovation basé sur l'automatisation et la garantie des procédés, soutenu par une vocation d'investissement à long terme.

LEADER EN QUALITÉ:

Dans le domaine de la Qualité, Alejandro Altuna S.A. a toujours été une entreprise pionnière et leader de son secteur. Notre politique de qualité est assise sur la prévention et la planification, l'amélioration continue, la satisfaction du client et la participation des personnes. Ces valeurs irriguent notre entreprise depuis sa création. Soutenues par une politique constante d'investissement en installations et machines, elles expliquent notre succès et, de plus, nous permettent d'assurer la compétitivité de l'entreprise et donc notre futur à long terme.

Bénéficiant de la Certification de Qualité selon la norme ISO 9001, Alejandro Altuna S.A. s'appuie sur des systèmes de gestion de la qualité homologués par les principaux constructeurs, aussi bien automobiles que du bâtiment. Aujourd'hui, notre entreprise est reconnue par le marché comme le leader du secteur.

LEADER EN ENGAGEMENT ENVIRONNEMENTAL:

Pour Alejandro Altuna S.A., les bonnes pratiques environnementales sont la règle et non l'exception. Notre équipe fait partie d'un projet entrepreneurial respectueux de l'environnement qui collabore au développement durable de notre milieu.

Alejandro Altuna S.A. a été le premier fabricant mondial de clés à obtenir, dès 2000, le certificat ISO 14001 pour son système de gestion. Ce système comporte deux piliers: la politique environnementale, où sont définis les valeurs et les engagements de l'entreprise, et les procédures qui développent les systèmes de travail et qui garantissent les bonnes pratiques environnementales dans tous les domaines d'activité.

LEADER EN SERVICE:

La réalité d'une entreprise se démontre par sa capacité à répondre le plus promptement et le plus efficacement possible aux besoins et aux exigences des clients, où qu'ils se trouvent.

JMA place à leur disposition 5 sites de production situés dans des lieux stratégiquement choisis. De plus, grâce à notre vaste réseau de filiales et de distributeurs répartis dans le monde entier, nous pouvons toucher tous nos clients, où qu'ils soient.

DEUTSCH:

FÜHREND IN TECHNOLOGIE:

Ein solider Einsatz für die Qualität und die Innovation, der sich auf Automatisierung und Prozesssicherheit sowie eine langfristige Investitionsgrundlage stützt.

FÜHREND IN QUALITÄT:

Auf dem Gebiet der Qualität war Alejandro Altuna S.A. stets ein führendes und bahnbrechendes Unternehmen des Sektors. Unsere Qualitätspolitik basiert auf Prävention und Planung, ständiger Verbesserung, Kundenzufriedenheit und Einbeziehung der Mitarbeiter.

Diese Werte sind schon seit den Anfängen fester Bestandteile unseres Unternehmens. Gemeinsam mit einer angemessenen Politik der Investition in Anlagen und Maschinenpark waren sie der wichtigste Grund für unseren Erfolg und sichern darüber hinaus die Wettbewerbsfähigkeit des Unternehmens und damit seine langfristige Zukunft.

Neben der Qualitätszertifizierung nach ISO 9001 verfügt Alejandro Altuna S.A. über Qualitätsmanagementsysteme, die von den führenden Automobil- und Wohnungsbauunternehmen zugelassen sind. Derzeit ist unser Unternehmen auf dem Markt für seine führende Position im Bereich Qualität bekannt.

FÜHREND IM UMWELTSCHUTZ:

Bei Alejandro Altuna S.A. sind gute Umweltschutzpraktiken die Regel, nicht die Ausnahme. Unsere Mitarbeiter sind Teil des Projekts des umweltfreundlichen Unternehmens, das sich für die nachhaltige Entwicklung unserer Umwelt einsetzt.

Alejandro Altuna S.A. erhielt im Jahr 2000 als weltweit erster Hersteller von Schlüsseln das Zertifikat ISO 14001 für sein Managementsystem. Dieses System umfasst die Umweltpolitik, die die Werte und Verpflichtungen des Unternehmens sowie die Verfahren für die Herstellungssysteme festlegt, und die korrekten Umweltschutzpraktiken in allen Unternehmensbereichen garantiert.

FÜHREND IM SERVICE:

Die Realität eines Unternehmens zeigt sich in seiner Fähigkeit, in optimalem Zeitrahmen und mit maximaler Effizienz auf die Bedürfnisse und Anforderungen der Kunden zu reagieren, unabhängig davon, wo diese sich befinden.

JMA verfügt über 5 Fertigungsstätten an strategischen Standorten. Dank eines über die ganze Welt ausgedehnten Netzes von Filialen und Vertriebspartnern ist das Unternehmen immer in der Nähe seiner Kunden, egal wo.

**14 COMPAÑÍAS EN 14 PAÍSES
400 PERSONAS Y
MÁS DE 450 MILLONES DE LLAVES AL AÑO
EN MÁS DE 100 PAÍSES EN TODO EL MUNDO.**

**El potencial de JMA en el mundo está cimentado a través de sus plantas productivas y filiales comerciales en Europa, América del Norte y del Sur, Asia y África.
La internacionalización es una estrategia prioritaria en JMA.**

JMA MUNDUAN

14 konpainia 14 herrialdean; 400 pertsona eta 450 milioitik gora giltza urtean, mundu zabaleko 100etik gora herrialdean.

JMA enpresak ahalmena du munduan, ekoizpen-lantegiak eta filial komertzialak dituelako Europan, Ipar Amerikan, Hego Amerikan, Asian eta Afrikan.
Izan ere, nazioarteko bihurtzea lehentasunezko estrategia da JMArentzat.

JMA WORLDWIDE

14 companies in 14 countries; 400 people and over 450 million keys sold in more than 100 countries all over the 5 continents

JMA's potential worldwide is based on its production plants and commercial subsidiaries in Europe, North and South America, Asia and Africa.
Globalisation is a priority strategy for JMA.

JMA DANS LE MONDE

14 sociétés dans 14 pays ; 400 personnes et plus de 450 millions de clés vendues chaque année dans plus de 100 pays de quatre continents

Le potentiel de JMA dans le monde est solidement ancré dans un réseau de production et de distribution qui couvre l'Europe, les deux Amériques, l'Asie et l'Afrique.
L'internationalisation est une stratégie prioritaire pour JMA.

JMA IN DER WELT

14 Unternehmen in 14 Ländern; 400 Personen und über 450 Millionen Schlüssel pro Jahr in über 100 Ländern der ganzen Welt.

Das Leistungspotenzial von JMA in der ganzen Welt wird durch seine Produktionsstätten und Handelsfilialen in Europa, Nord- und Südamerika, Asien und Afrika konsolidiert. Internationalisierung ist eine vorrangige Strategie von JMA.



● **PLANTAS PRODUCTIVAS**
MANUFACTURING PLANTS

● **CENTROS DE DISTRIBUCIÓN**
DISTRIBUTION CENTERS

JMA EN EL MUNDO

JMA WORLDWIDE

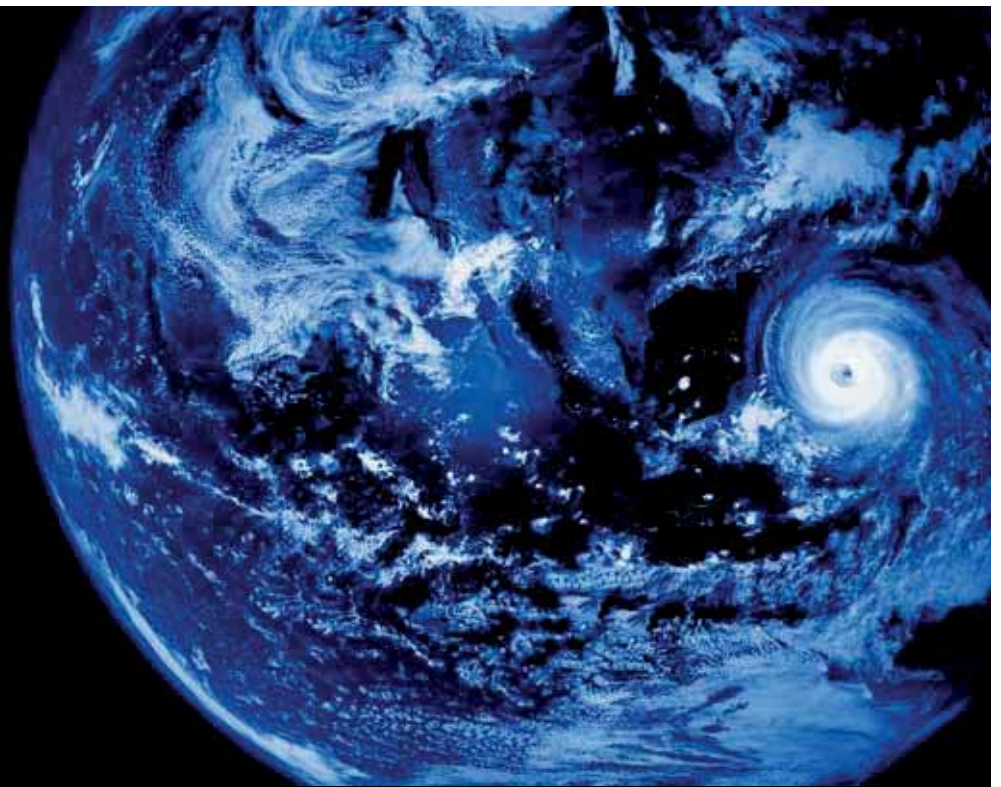

THE KEY TO EXCELLENCE
GLOBALLY UNLOCKING MILLIONS OF DOORS DAILY

ESPAÑOL

- 1 MARCA PRINCIPAL
- 2 CABEZA
- 3 CUELLO
- 4 TOPE
- 5 PALETÓN
- 6 PUNTA
- 7 UTILIZACIÓN
- 8 NOMENCLATURA DE PERFIL ORIGINAL
- 9 PERFIL IZQUIERDO
- 10 PERFIL DERECHO
- 11 REFERENCIA
- 12 MARCAS SECUNDARIAS
- 13 SERIES

1 ABSA

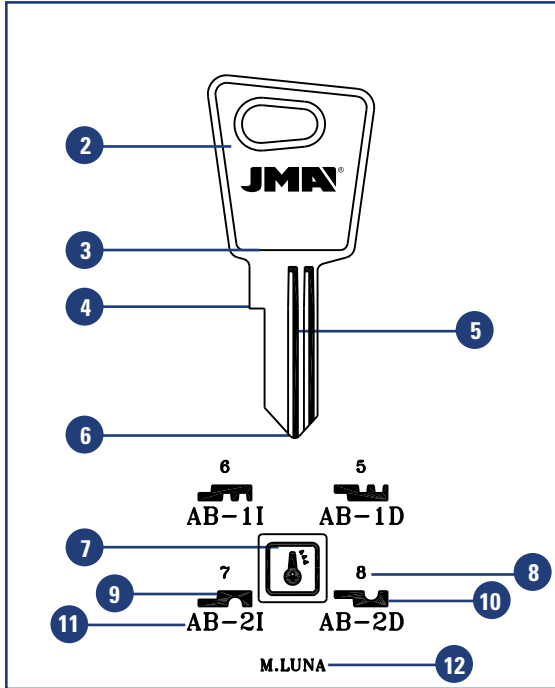

1 VACHETTE

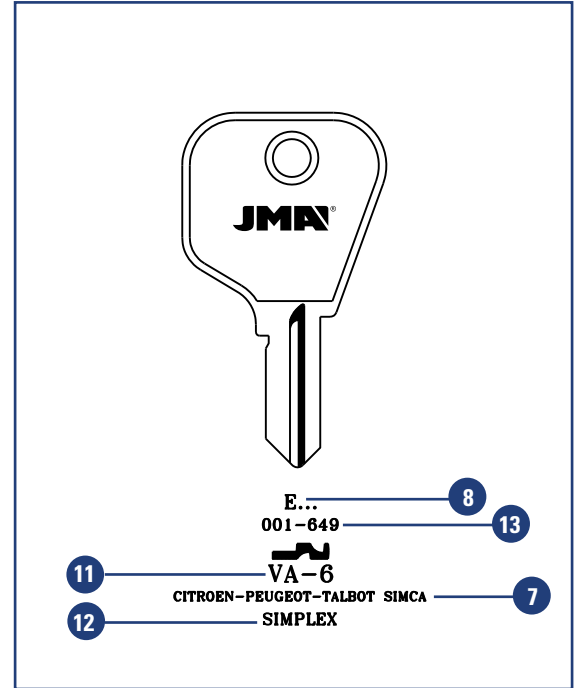

EUSKERA	ENGLISH	FRANÇAIS	DEUTSCH
1 MARKA NAGUSIA	1 MAIN BRAND	1 MARQUE PRINCIPALE	1 HAUPTPRÄGUNG
2 BURUA	2 HEAD	2 TÊTE	2 KOPF
3 LEPOA	3 NECK	3 COU	3 HALS
4 TOPEA	4 SHOULDER	4 ARRÊT	4 ANSCHLAG
5 BELARRIA	5 BLADE	5 CANON	5 SCHAFT
6 PUNTA	6 TIP	6 POINTE	6 SPITZE
7 ERABILERA	7 USE	7 UTILISATION	7 VERWENDUNG
8 JATORRIZKO PROFILAREN IZENDEGIA	8 ORIGINAL PROFILE	8 PROFIL ORIGINAL	8 ORIGINALPROFIL
9 EZKERREKO PROFILA	9 LEFT PROFILE	9 PROFIL GAUCHE	9 LINKSPROFIL
10 ESKUINEKO PROFILA	10 RIGHT PROFILE	10 PROFIL DROIT	10 RECHTSPROFIL
11 ERREFERENTZIA	11 REFERENCE	11 RÉFÉRENCE	11 BEZEICHNUNG
12 BIGARREN MAILAKO MARKAK	12 SECONDARY BRAND	12 MARQUE SECONDAIRE	12 2. PRÄGUNG
13 SERIEAK	13 SERIES	13 CODE	13 SERIE

DESCRIPCIÓN Y TERMINOLOGÍA

KEY DESCRIPTION AND TERMINOLOGY

ESPA-

- 1 CABEZA
- 2 CUELLO
- 3 DIÁMETRO DE LA CAÑA
- 4 CAÑA
- 5 LONGITUD A
- 6 PALETON
- 7 PERFIL MACHO
- 8 REFERENCIA
- 9 MARCA ORIGINAL
- 10 PERFIL HEMBRA

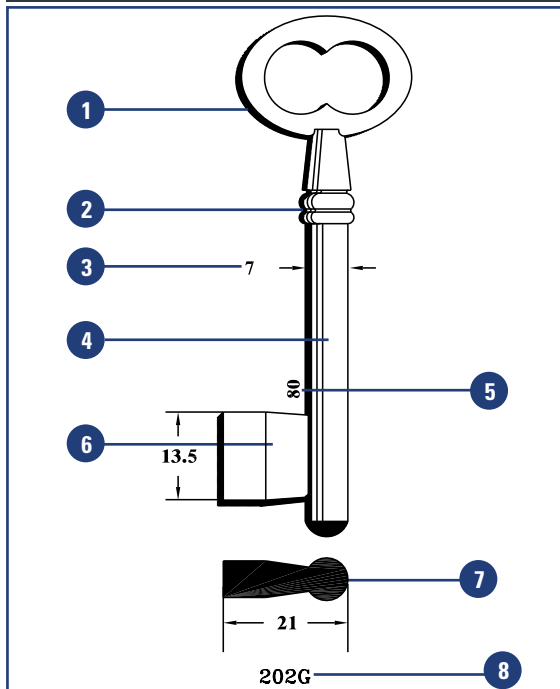

9 — ORENGO

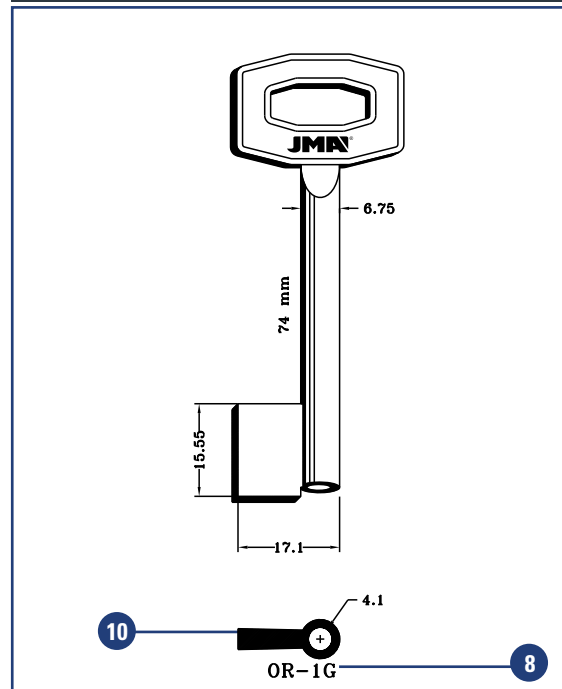

EUSKERA	ENGLISH	FRANÇAIS	DEUTSCH
1 BURUA	1 HEAD	1 TÊTE	1 KOPF
2 LEPOA	2 NECK	2 COU	2 HALS
3 ZIRIAREN DIAMETROA	3 SHANK DIAMETER	3 DIAMETRE DU CANON	3 HALM- DURCHMESSER
4 ZIRIA	4 SHANK	4 CANON	4 HALM
5 A LUZERA	5 LENGTH A	5 LONGUEUR A	5 LÄNGE A
6 BELARRIA	6 BIT	6 PANNETON	6 BART
7 PROFIL ARRA	7 PIN BIT PROFILE	7 PROFIL MALE	7 SCHWEIFUNG
8 ERREFERENTZIA	8 REFERENCE	8 RÉFÉRENCE	8 BEZEICHNUNG
9 JATORRIZKO MARKA	9 ORIGINAL BRAND	9 MARQUE ORIGINALE	9 ORIGINAL- PRÄGUNG
10 PROFIL EMEA	10 PIPE BIT PROFILE	10 PROFIL FEMELLE	10 GEBOHRT

ALP.

Llave fabricada en alpaca

Alpakaz egindako giltza
Key available in nickel silver
Clé fabriquée en maillechort
Schlüssel auch in Neusilber lieferbar

LAT.

Llave disponible también en latón

Giltza, letoizkoa ere eskuragarria
Key also available in brass
Clé aussi disponible en laiton
Schlüssel auch in Messing lieferbar

COL.

Llave disponible también con cabeza de plástico en colores

Giltza hau koloretako plastikozko buruarekin ere eskuragarria

Key also available with coloured plastic head

Clé aussi disponible avec tête plastifiée en couleurs

Schlüssel auch mit farbigem Plastikkopf lieferbar

ALU.

Llave disponible también en aluminio

Giltza, aluminioan ere eskuragarria
Key also available in aluminium
Clé aussi disponible en aluminium
Schlüssel auch in Aluminium lieferbar

ZAM.

Llave fabricada solamente en zamak

Zamakez soilik egindako giltza
Key only available in zamak
Clé aussi disponible en zamak
Schlüssel nur aus Zamak lieferbar



Llave de utilizacion en candados

Giltzarrapoetan erabiltzeko giltzak
Key for padlocks
Clé pour cadenas
Schlüssel für Hangschlösser



Llave de utilización en cerraduras auxiliar

Sarraila osagarrietan erabiltzeko giltzak
Key for cam locks
Clé pour petite serrurie
Schlüssel für Hebelschlösser



Llaves para motocicletas

Motozikleta giltzak
Key for motorcycles
Clé pour motocyclettes
Schlüssel für Motorräder



Llave para tapón de gasolina

Gasolina-tapoietarako giltza
Key for fuel cap
Clé pour bouchon d'essence
Schlüssel für Tankdeckel



Llave para camión

Kamioiko giltza
Key for lorries
Clé pour camion
Schlüssel für Lastkraftwagen



Alarma

Alarma
Alarm
Alarme
Alarm



Llaves gorja con acabado en color natural

Gorja giltzak berezko kolorezko akaberarekin
Bit key blank with natural colour finishing
Clé à gorges avec finition en couleur naturel
Chubbschlüssel in naturfarben Ausführung



Llaves gorja con acabado en negro antiguo

Gorja giltza, beltz zaharkitu akaberarekin
Bit key blank with old black finishing
Clé à gorges avec finition en vieux noir
Chubbschlüssel in altschwarzer Ausführung

NACIONALIDAD - NAZIONALITATEA - NATIONALITY - NACIONALITÉ - NATIONALITÄT

AUSTRIA
AUSTRALIA
BELGIUM
BRAZIL
CANADA
SWITZERLAND
GERMANY
DENMARK

A
AUS
B
BR
CDN
CH
D
DK

ALGERIA
SPAIN
ESLOVAKIA
EGYPT
FRANCE
GREAT BRITAIN
GREECE
HUNGARY

DZ
E
ES
ET
F
GB
GR
H

HONG KONG
CROATIA
ITALY
ISRAEL
INDIA
EIRE
JAPAN
KOREA

HK
HR
I
IL
IND
IRL
J
K

SÍMBOLOS

SYMBOLS

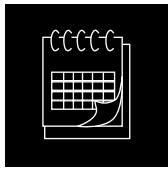

Calendario

Egutegia
Calendar
Calendrier
Kalender

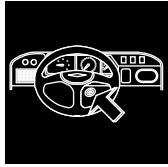

Contacto auto

Autoko kontaktua
Engine ignition
Contact auto
Zündschloss Pkw

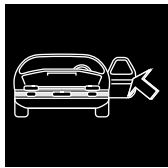

Puerta

Atea
Door lock
Portière
Türe

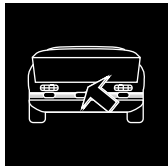

Maletero/Puerta trasera

Maletategia/Atzeko atea
Boot/Hatchback
Coffre/Portière postérieure
Kofferraum/Hecktür



Tapón de gasolina

Gasolina-tapoia
Petrol cap
Bouchon réservoir
Benzintankverschluss

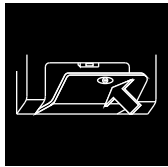

Guantera

Eskularru-kutxa
Drawer
Tiroir
Schublade

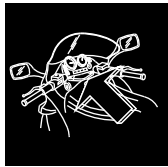

Contacto moto

Moto-kontaktua
Motorbike ignition
Contact moto
Zündschloss Motorrad

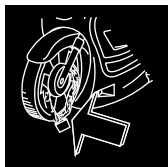

Bloqueo moto

Moto-blokeoa
Motorbike disc lock
Bloquage moto
Bremsenschloss Motorrad

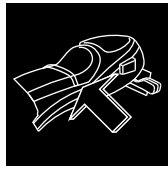

Sillin

Zela
Cycle seat
Selle
Sattel

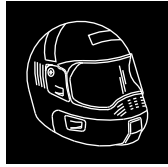

Casco

Kaskoa
Helmet
Casque
Helm

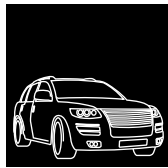

Automovil / camioneta

Automobila / kamioneta
Car / Pick-up trucks
Voiture / Camionnette
Auto / Kleintransporter

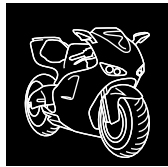

Motocicleta

Motozikleta
Motorcycle
Motocyclette
Motorrad



Camión

Kamioia
Trucks
Camion
Lkw

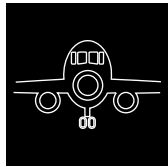

Avión

Hegazkina
Aeroplane
Avion
Flugzeuge

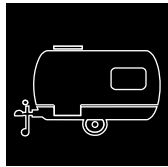

Caravana

Karabana
Caravans
Caravane
Wohnwagen

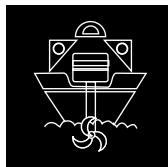

Motor marino

Itsas motorra
Boat engines
Moteur de bateau
Schiffsmotoren

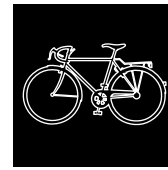

Bicicleta

Bizikleta
Bicycle
Bicyclette
Fahrräder

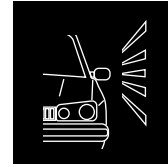

Alarma

Alarma
Alarm
Alarme
Alarm

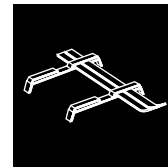

Portaesquis

Eski-euskarria
Ski holder
Porte ski
Skiträger

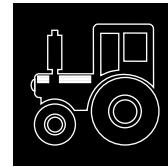

Tractor

Traktorea
Tractor
Traktor
Landmaschinen

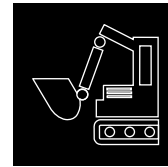

Escavadora

Hondeatzailea
Earth moving machine
Machine déplacement de terre
Baumaschinen



Carretilla elevadora

Orga jasotzailea
Forklift
Clark
Gabelstapler

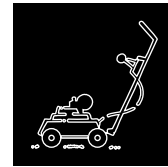

Corta cesped

Belarra mozteko makina
Lawn-mower
Tondeuse
Rasenmäher



Alarma - llave

Alarma - giltza
Alarm - key
Alarme - clef
Alarm - Schlüssel

KUWAIT
MEXICO
NORWAY
THE NETHERLANDS
PORTUGAL
PERU
POLAND
ARGENTINA

KW
MEX
N
NL
P
PE
PL
RA

TAIWAN
CHILE
CHEKIA
RUMANIA
SWEDEN
FINLAND
SLOVENIA
RUSIA

RC
RCH
RCZ
RU
S
SF
SLO
RUS

CHINA
TUNISIA
UNITED STATES OF AMERICA
YUGOSLAVIA
VENEZUELA
ZAMBIA

TJ
TN
USA
YU
YV
Z

LLAVES

GILTZAK

KEYS

CLES

SCHLÜSSEL



SUPLEMENTO-SUPPLEMENT 2011.C10

THE KEY TO EXCELLENCE
GLOBALLY UNLOCKING MILLIONS OF DOORS DAILY

ÍNDICE GENERAL

AURKIBIDE OROKORRA • GENERAL INDEX • INDEX GENERALE • GESAMTVERZEICHNIS

REF.	PAG.
3M-1D	1
A	
ABU-57	1
ABU-73D	1
ABU-74	1
ABU-74D	1
ABU-75D	1
ABU-76	1
ABU-77	1
ABU-78	1
ABU-79	1
ABU-80	1
ABU-81	1
AGA-48	1
AGA-49	1
AGA-50	2
AGA-51	2
AGA-52	2
AS-28	2
AS-MG5	2
AZ-37	2
AZ-37D	2

B	
BAB-17D	2
BH-8	20
BK-16/ 1	2
BK-16/ 2	2
BK-16/ 3	2
BK-16/ 4	2
BK-16/ 5	2
BK-16/ 7	2
BK-16/ 9	2
BK-16/10	2
BK-16/13	2
BK-16/14	2
BK-16/15	2
BK-16/16	2
BK-16/17	2
BK-16/18	2
BK-16/19	2
BK-16/20	2
BK-16/21	2
BK-16/23	2
BK-17/1PZ	3
BK-17/2PZ	3
BK-17/5PZ	3
BK-17/6PZ	3

REF.	PAG.
BK-17/7PZ	3
BK-17/8PZ	3
BK-17/9PZ	3
BK-17D/1	3
BK-17D/1PZ	3
BK-17D/2	3
BK-17D/2PZ	3
BK-17D/3	3
BK-17D/3PZ	3
BK-17D/4	3o
BK-17D/4PZ	3
BK-17D/5	3
BK-17D/6	3
BK-17D/7	3
BK-17D/8	3
BK-17D/9	3
BK-18/ 1	3
BK-18/ 2	3
BK-18/ 3	3
BK-18/ 4	3
BK-18/ 5	3
BK-18/ 6	3
BK-18/ 7	3
BK-18/ 9	3
BK-18/10	3
BK-18/11	3
BK-18/13	3
BK-18/14	3
BK-18/15	3
BK-18/16	3
BK-18/17	3
BK-18/18	3
BK-18/20	3
BK-18/21	3
BK-18/22	3
BK-18/23	3
BK-18/24	3
BK-18/25	3
BK-18/26	3
BK-18/27	3
BK-18/28	3
BK-18/29	3
BK-18/30	3
BK-18/31	3
BK-18/32	3
BK-18/33	3
BK-18/34	3
BK-19/ 1	3
BK-19/ 2	3
BK-19/ 4	3
BK-19/ 5	3

REF.	PAG.
BK-19/ 6	3
BK-19/ 7	3
BK-19/ 8	3
BK-19/10	3
BK-19/11	3
BK-19/12	3
BK-19/13	3
BK-19/15	3
BK-19/16	3
BK-19/19	3
BK-19/20	3
BK-19/21	3
BK-19/23	3
BK-19/25	3
BK-19/26	3
BK-19/27	3
BK-19/31	3
BK-19/32	3
BK-20	4
BLU-2X	24
BMB-1	4
BMB-2	4
BSS-6D	4
BSS-7D	4
BTV-3	4
BUR-26D	4
BUR-27D	4
BUR-28	4
BUR-29	4
BUR-29D	4
BUR-30D	20
BUR-31D	4
BUR-32D	4
BUR-33	5

C	
CAB-1D	5
CE-130	5
CE-131D	5
CE-132/15	5
CE-132/16	5
CE-132/17	5
CE-132/18	5
CE-132/25	5
CE-132/26	5
CE-132/27	5
CE-132/35	5
CE-132/36	5
CE-132/37	5
CE-132/38	5

REF.	PAG.
CE-132/45	5
CE-132/46	5
CE-134	5
CE-135D	5
CI- 3PG	24
CI-34D	6
CI-62D	5
CI-63	6
CI-63D	6
CI-64D	6
CI-65	6
CI-66D	6
CIN-1	5
CIN-1D	5
CIS-7D	5
COR- 24D	6
COR- 62	6
COR-115D	6
COR-153	6
CR-19G	24
CRO-1G	24

D	
DAE-3D	20
DAE-4D	20
DOM-27/12	6
DOM-27/13	6
DOM-27/16	6
DOM-27/19	6
DOM-27/35	6
DOM-28D	6
DOM-53D	7
DOM-54D	7
DOM-55	7
DOM-55D	7
DOM-56D	7
DOM-57D	7
DOM-58D	7
DOM-59	7
DOM-60D	7
DOM-61	7
DOM-62D	7
DOM-63D	7
DOM-64D	7
DOM-65	7
DOM-66D	7
DOM-67D	7
DOM-68	7
DR-1	6

ÍNDICE GENERAL

GENERAL INDEX

REF.	PAG.
------	------

E

ESS-9D	7
EU-12	7
EU-13D	7
EV-19	8
EV-20D	8
EV-23D	7
EXS-2D	8
EXS-3	8
EXS-3D	8
EXS-4D	8
EXS-5	8
EXS-5D	8
EXS-6	8

F

FAC-24	8
FI-16P1	21
FLO-2D	20
FRI-3	8
FTH-30	8
FTH-31	8

G

GE-21	8
GE-21D	8
GEA-6D	8
GEA-7D	8
GH-2	20
GH-3	20
GTV-10	9
GTV-11	9
GW-1D	20

H

HD-4D	20
HOND-24DP	20
HOND-43	20
HOND-43D	20
HOND-43DP	20
HOND-43P	20
HTE-1D	9
HU-NW	20
HUW-2	9

I

ILS-1	10
IS-18D	11
IS-19D	11
ISU-3D	21

REF.	PAG.
------	------

J

JPM-10D	11
JWL-9	11
JWL-9D	11
JWL-10D	11
JWL-11D	11

K

KE-5	11
KFV-C	11
KFV-D	11
KFV-E	11
KFV-F	11
KFV-L	11
KFV-M	11
KFV-N	11
KFV-O	11

L

LF-43	12
LIN-25	11
LIN-25D	11
LIT-2GD	11
LT-1	12

M

MAG-2DP	12
MCM-27	12
MLM-5D	12
MOD-1DP	21
MPA-1G	24
MT-3P1G	25
MT-5P1G	25
MT-6P1G	25
MT-8P1G	25
MT-9P1G	25
MT-10P1G	25
MT-18G	25
MUL-T 8P1	12
MUL-T 9P1	12
MUL-T11P1	12

N

NE-61D	21
NE-62	21
NE-63D	21

R

RU-19D	12
--------	----

REF.	PAG.
------	------

S

SER-3D	12
STE-13D	13
STE-14D	13
STUV-3	13

T

TC-1	13
TIT-2GD	13
TIT-8GD	13
TOK-21D	14
TOK-37	14
TOK-38	14
TOK-39	14
TOK-40	14
TOK-41	14
TOK-42	14
TOK-43	14
TOK-44	14
TOK-44D	14
TOK-45	14
TOK-45D	14
TOK-46	14
TOK-47	14
TOK-47D	14
TOK-48	14
TOK-48D	14
TOK-49	14
TOK-50	14
TOK-51	14
TOK-52	14
TOK-53	14
TOK-54	14
TOK-55	14
TOK-56D	13
TOK-58	13
TOK-59	13
TOK-60	13
TOK-61	13
TOK-62	14
TOK-62D	14
TOK-63	14
TOK-64	14
TOK-65	14
TOK-66	14
TOK-67	14
TOK-68	14
TOK-69	14
TOK-70	14
TOK-71	14
TOK-72	14
TOK-73	14
TOK-74	14
TOK-75	13
TOK-76	13

REF.	PAG.
------	------

TOK-77	13
TOK-78	13
TOYO-12DP1	21
TOYO-37D	21
TRL-2	14
TX-2	14

U

U-26	14
U-26D	14

V

VI-15	15
VI-16D	15

W

WE-6D	15
WIL-24	15
WIL-25	15
WIL-26	15
WIL-27	15
WIL-28	15
WIL-29	15
WIL-30	15
WIL-31D	15
WIL-32	15
WIL-33D	15
WIL-34D	15
WIL-35D	15
WIL-36D	15
WIL-37D	15
WIL-38D	15
WIL-39D	15
WIL-40D	15
WIL-41D	15
WIL-43D	15
WIL-44	15
WIL-45D	15
WIL-46D	15
WIL-47D	15
WIL-48D	15
WIL-49D	15
WIL-50D	15
WIL-51D	15
WIL-52	15
WIL-53	15
WIL-54	15
WIL-55	15
WIL-56	15
WIL-57D	15
WNC-1	15

REF.	PAG.
------	------

Y

YA- 57	15
YA- 57D	15
YA- 58D	15
YA- 59D	15
YA- 91	15
YA- 91D	15
YA- 92	15
YA- 92D	15
YA- 94	15
YA- 95	15
YA- 97D	16
YA- 98D	16
YA- 99D	16
YA-100D	16
YA-101D	16
YA-102D	16
YA-103D	16
YA-108	16
YA-111	16
YA-112	16
YA-113	16
YA-142D	16
YA-186D	16
YA-206D	16
YA-208D	16
YA-209D	16
YA-210D	16
YA-212D	16
YA-216	17
YA-217	17
YA-219	17
YA-220	17
YA-221	17
YA-225	17
YA-226	17
YA-227	17
YA-228	17
YA-229	17
YA-232	17
YA-272D	16
YA-273D	16
YAR-3	17
YUH-1D	17
YUH-2D	17
YW-1P	17-21

REF.	PAG.
------	------

Z

ZA-5DP	21
ZE- 14D	10
ZE- 15	9
ZE- 16D	9
ZE- 17D	9
ZE- 18D	9
ZE- 19	9
ZE- 20	9
ZE- 21D	9
ZE- 22	9
ZE- 23D	10
ZE- 24D	10
ZE- 25D	10
ZE- 26D	10
ZE- 27D	10
ZE- 28D	10
ZE- 29D	10
ZE- 30D	10
ZE- 31D	10
ZE- 32D	10
ZE- 33D	10
ZE- 34D	10
ZE- 35	10
ZE- 35D	10
ZE- 36D	9
ZE- 37D	9
ZE- 38	9
ZE- 39	9
ZE- 40D	9
ZE- 41	9
ZE- 42	9
ZE- 43	9
ZE- 44D	9
ZE- 45D	9
ZE- 46	9
ZE- 47D	10
ZE- 48D	10
ZE- 49D	10
ZE- 50D	10
ZE- 51D	10
ZE- 52D	10
ZE- 53D	10
ZE- 54D	10
ZE- 55D	10
ZE- 56D	10
ZE- 57D	10
ZE- 58D	10
ZE- 59D	10
ZE- 60D	10
ZE- 61D	10
ZE- 62D	10
ZE- 63D	10
ZE- 64D	10
ZE- 65D	10
ZE- 66D	10

REF.	PAG.
------	------

ZE- 67D	10
ZE- 68D	10
ZE- 69D	10
ZE- 70D	10
ZE- 71D	9
ZE- 72	9
ZE- 73	9
ZE- 74	9
ZE- 75	9
ZE- 76D	9
ZE- 77D	9
ZE- 78D	9
ZE- 79	9
ZE- 80	9
ZE- 81	9
ZE- 82	9
ZE- 83	9
ZE- 84	9
ZE- 85	9
ZE- 86D	9
ZE- 87	9
ZE- 88	9
ZE- 89	9
ZE- 90	9
ZE- 91D	9
ZE- 92D	9
ZE- 93D	9
ZE- 94D	9
ZE- 95D	9
ZE- 96D	9
ZE- 97D	9
ZE- 98	9
ZE- 99	9
ZE-100	9
ZE-101	9
ZE-102	9
ZE-103	9
ZE-104D	9
ZE-105D	10
ZE-106D	10
ZE-107D	10
ZE-108D	10
ZE-109D	10
ZE-110D	10
ZE-111D	10
ZE-112D	10
ZE-113D	10
ZE-114D	10
ZE-115D	10
ZE-116D	10
ZE-117D	10
ZE-118	9
ZE-119D	9
ZE-120	9
ZE-121D	9
ZE-122D	9
ZE-123D	9

REF.	PAG.
------	------

ZE-124	9
ZE-125D	10
ZE-126D	10
ZE-127D	10
ZE-128	9
ZE-129D	9
ZE-130	9
ZE-131	9
ZE-132D	9
ZE-133D	9
ZE-134	9
ZE-135D	9
ZE-136D	10
ZE-137	9
ZE-138	9
ZE-139D	9
ZE-140	9
ZE-141D	10
ZE-142	9
ZE-143	9
ZE-144D	9
ZE-145D	10
ZE-146D	10
ZE-147D	10
ZE-148D	10

ÍNDICE DE MARCAS

BRAND INDEX

ÍNDICE DE MARCAS

MARKEN AURKIBIDEA • BRAND INDEX • INDEX MARQUE • HAUPTMARKE

MARCA - MARKA - MAIN MARQUE - MARKE	PÁG. - ORRIA - PAGE - PAGE - SEITE
--	---------------------------------------

3M	1
----	---

A

ABUS	1 6 17 21
AGA	1 2
ALA	6
ASSA	2
ATRA	6
AZBE	2

B

BAB	2 7
BANE SEKULIC	4
BKS	2 3 4 16 17
BLACK & DECKER	6
BLUMA	24
BMB	4
BOSCH	20
BSS	4
BTV	4
BURG	4 5 20

C

CAB	5
CAS CISMA	5
CES	5
CHANGE-O-MATIC	6
CINA	5
CISA	1 5 6 24
COMBA	11
CORBIN	6
CR	24
CRONOS	24

D

DAEWOO	20
DIERRE	6
DOM	6 7 12 13

E

ESS	7
EURO LOCKS	7
EVVA	7 8
EXPRES	8

F

FAC	8
-----	---

MARCA - MARKA - MAIN MARQUE - MARKE	PÁG. - ORRIA - PAGE - PAGE - SEITE
--	---------------------------------------

FAI	15
FCV	11
FEDERAL	8
FLIETHER	11
FLORA	20
FRIPA	8
FTH	8

G

GAMMA	12
GE GE	4 8 13
GERA	8
GEWIRU	7
GEWU	20
GHE	20
GIESCHE	11
GIOBERT	21
GOTZ	11
GRAF	11
GTV	9 11

H

HAMPTON	14
HARLEY DAV.	20
HONDA	20
HSA	11
HTEC	9
HUF	20
HUWIL	9

I

IKON	9 10
ILS	10
ISEO	11 14
ISUZU	21

J

JOWIL	11
JPM	1 11

K

KASSBOHRER	20
KESO	11
KFV	11
KOLB	20

MARCA - MARKA - MAIN MARQUE - MARKE	PÁG. - ORRIA - PAGE - PAGE - SEITE
--	---------------------------------------

L	
LAPORTE	20
LINCE	11
LITTO	11
LOWE & FLETCHER	12
LT	12

M

MAGNUM	7
MOFA	12
MOTTURA	14
MP	14

N

NEIMAN	21
NICO	11

P

PEROHAUS	20
POS	20
PZ	3

R

RUKO	12
RUNO	20

S

SCHUCO	1 11
SEN	11
SERRALLER	12
SISO	8
STEM	13
STUV	7 12 13

T

TECON	13
THIRARD	8
TIEFENTHAL	9
TITAN	13
TOK WINKHAUS	13 14
TOYOTA	21
TRELOCK	13 14
TRW-SIPEA	21

MARCA - MARKA - MAIN MARQUE - MARKE	PÁG. - ORRIA - PAGE - PAGE - SEITE
--	---------------------------------------

U

UNIVERSAL	14
-----------	----

V

VIRO	15
------	----

W

WECO	20
------	----

WELKA	15
-------	----

WILKA	15
-------	----

WINLOCK	15
---------	----

MARCA - MARKA - MAIN MARQUE - MARKE	PÁG. - ORRIA - PAGE - PAGE - SEITE
--	---------------------------------------

Y

YALE	3 15 16 17
------	------------

YARDENI	17
---------	----

YUN HUAN	17
----------	----

YWS	17 21
-----	-------

Z

ZADI	21
------	----

ZUNDAPP	20
---------	----

LLAVES PLANAS PARA CERRADURAS DE CILINDRO

SARRAILA ZILINDRIKOTARAKO GILTZA ZAPALAK

CYLINDER KEYS

CLÉS POUR CYLINDRES

ZYLINDERSCHIÜSSEL



THE KEY TO EXCELLENCE

GLOBALLY UNLOCKING MILLIONS OF DOORS DAILY

3M

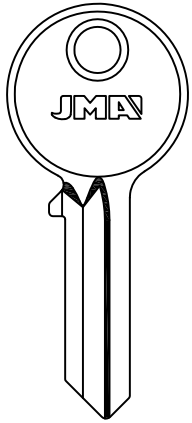

3M-1D

ABUS

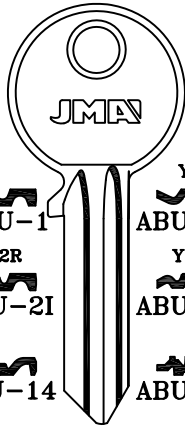

ABU-1

Y2R
ABU-2I

ABU-14

ABU-44

ABU-46

Y1
ABU-1D

Y2L
ABU-2D

ABU-7D

ABU-43D

ABU-46D

ABU-49

ABU-53

X4S
ABU-55

ABU-67

ABU-69

NEW
ABU-74

X2S
NEW
ABU-76

ABU-52D

ABU-55D

ABU-67D

ABU-71D

NEW
ABU-74D

NEW
ABU-77

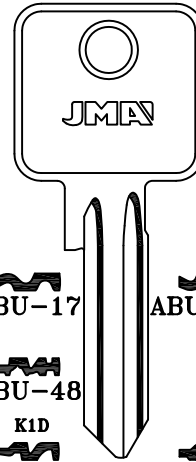

ABU-17

ABU-48

K1D
ABU-70

NEW
ABU-77

ABU-17D

ABU-58D

NEW
ABU-80

CISA-JPM-SCHUCO

CISA

PARA-FOR:

3M (PRC)
ABUS (D)
AGA (E)

ABUS

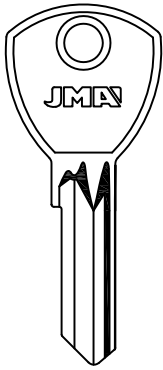

8.25
2.85
ABU-61

ABU-63

ABU-66

NEW
ABU-81

LAT.

LAT.

NEW
ABU-57 ABU-57D

ABU-73D

ABU-75D

ABUS

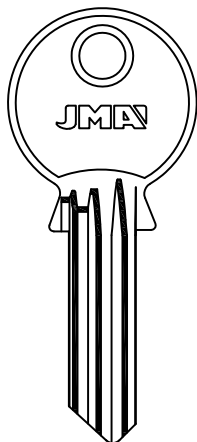

LAT.

004
ABU-78

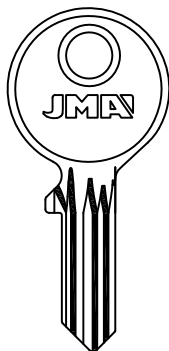

AL
ABU-79

AGA

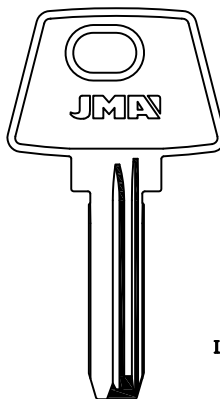

LAT.

7
2.35
AGA-38

NEW
AGA-42 AGA-48

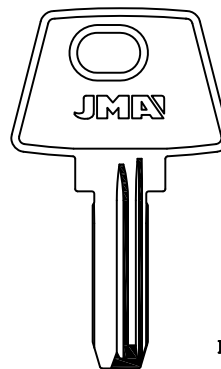

LAT.

7
2.35
AGA-39

NEW
AGA-43 AGA-49

JMA

Copyright by Alejandro Altuna S.A. 2012



ATENCIÓN: Concerniente a las marcas y denominaciones comerciales ver nota en índice.
ATTENTION: Concerning the marks and commercial denominations see note in index.
ATTENTION: Concernant les marques et dénominations commerciales voir la note dans l'index.
ACHTUNG: Beziehen auf die Marke und Handelsname sehen sie die Notiz im Index.

PARA-FOR: AGA

AGA (E)
ASSA (S)
AZBE (E)
BAB (D)
BKS (D)

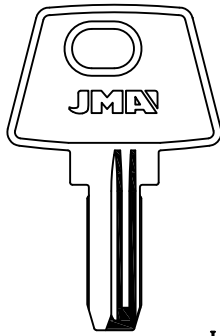

LAT.

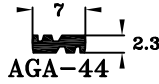

NEW
AGA-50

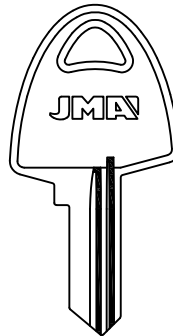

11I
AGA-51

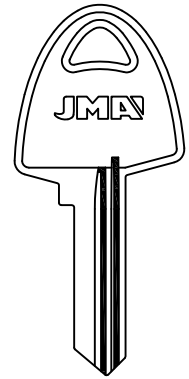

12I
AGA-52

ASSA

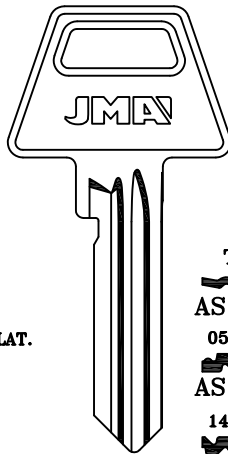

* LAT.

TL
AS-4D
05-04
AS-5D
14-01
AS-6D
05-13
AS-7D

14-09
AS-8D
14-25
AS-9D
05-05
AS-10D
AS-11D
11-14
AS-12D

11-01
AS-13D
11-12
AS-14D
11-32
AS-15D
11-08
AS-16D
05-14
AS-18D
TM
AS-25D
NEW
* AS-28

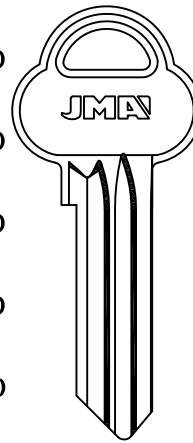

31 mm.

NEW
560MG
AS-MG5
560KE
AS-KE5
560ME
AS-ME5

AZBE

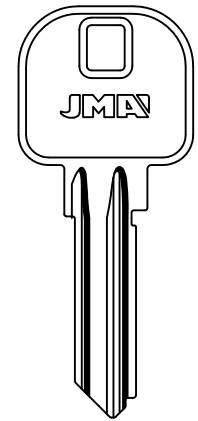

AZ-37 AZ-37D

BAB

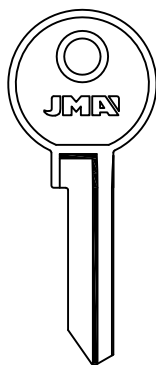

LAT.

BAB-17D

BKS

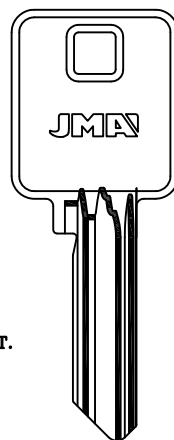

* LAT.







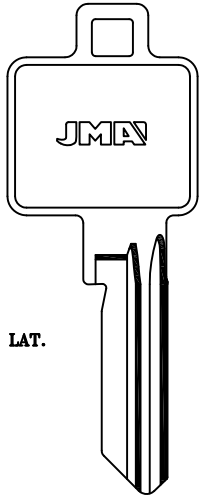













* BK-16/9 * BK-16/18
* BK-16/7 * BK-16/17
* BK-16/5 * BK-16/16 BK-16/30
* BK-16/4 * BK-16/15 * BK-16/23
* BK-16/3 * BK-16/14 * BK-16/21
* BK-16/2 * BK-16/13 * BK-16/20
* BK-16/1 * BK-16/10 * BK-16/19

SERIE 2000





LAT.







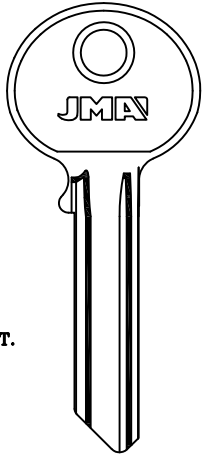























 BK-17/9PZ	 BK-17D/7		
 BK-17/8PZ	 BK-17D/6		
 BK-17/7PZ	 BK-17D/5		
 BK-17/6PZ	 BK-17D/4PZ	 BK-17D/4	
 BK-17/5PZ	 BK-17D/3PZ	 BK-17D/3	
 BK-17/2PZ	 BK-17D/2PZ	 BK-17D/2	 BK-17D/9
 BK-17/1PZ	 BK-17D/1PZ	 BK-17D/1	 BK-17D/8

PZ-YALE

SERIE 0









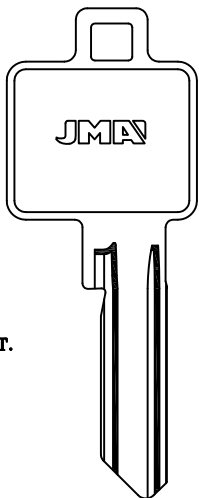















LAT.

 BK-18/7	 BK-18/16	 BK-18/24	 BK-18/31	
 BK-18/6	 BK-18/15	 BK-18/23	 BK-18/30	
 BK-18/5	 BK-18/14	 BK-18/22	 BK-18/29	
 BK-18/4	 BK-18/13	 BK-18/21	 BK-18/28	
 BK-18/3	 BK-18/11	 BK-18/20	 BK-18/27	 BK-18/34
 BK-18/2	 BK-18/10	 BK-18/18	 BK-18/26	 BK-18/33
 BK-18/1	 BK-18/9	 BK-18/17	 BK-18/25	 BK-18/32

SERIE 1000



LAT.

 BK-19/8	 BK-19/19	 BK-19/31	
 BK-19/7	 BK-19/16	 BK-19/27	
 BK-19/6	 BK-19/15	 BK-19/26	
 BK-19/5	 BK-19/13	 BK-19/25	
 BK-19/4	 BK-19/12	 BK-19/23	
 BK-19/2	 BK-19/11	 BK-19/21	
 BK-19/1	 BK-19/10	 BK-19/20	 BK-19/32



PARA-FOR:

BKS

BKS (D)
 BMB (D)
 BSS (SCG)
 BTV (E)
 BURG (D)

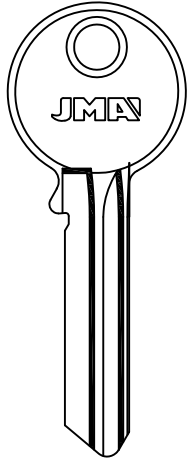

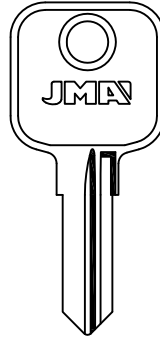

 BK-20

BMB

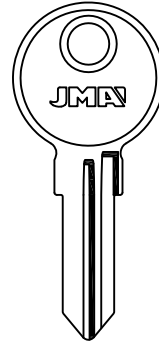

A
 BMB-1



A...401-600
 BMB-2

LAT.

BSS

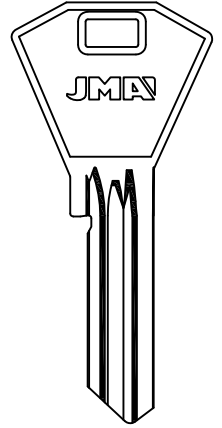

 BSS-5D
NEW
 BSS-7D

BANE SEKULIĆ-GE GE

BSS

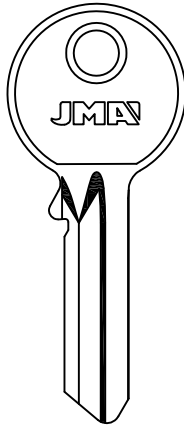

 BSS-6D

BANE SEKULIĆ

LAT.

BTV

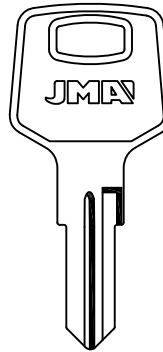

 BTV-3

BURG

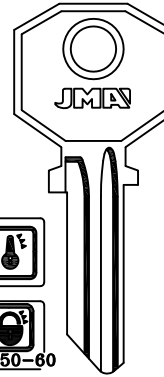

40-50-60
 1/91/9...
 0 AL 6
 BUR-1I BUR-1D
NEW
 *BUR-27D

*LAT.

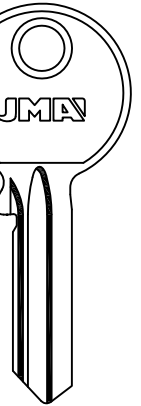

 BUR-26D

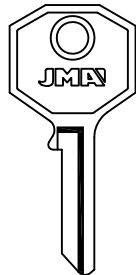

LAT.

BURG

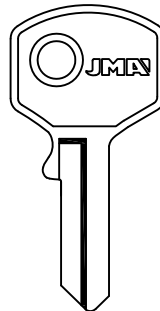

 BUR-28



 BUR-29  BUR-29D

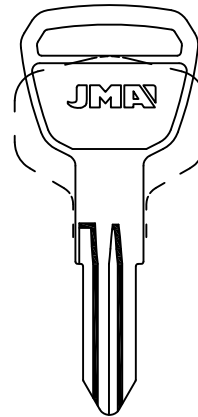

ZBK 70/74
 ZS 85/86
 BUR-31D

LAT.

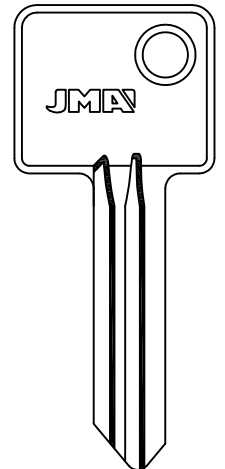

 BUR-32D

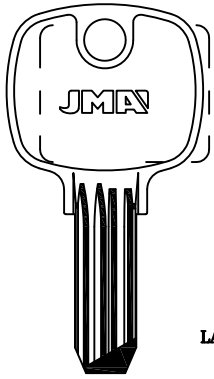

BURG

LAT.

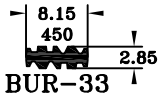

BUR-33

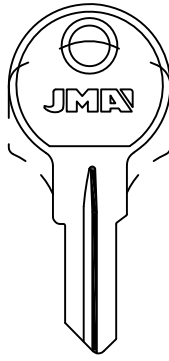
CAB

LAT.

CAB-1D

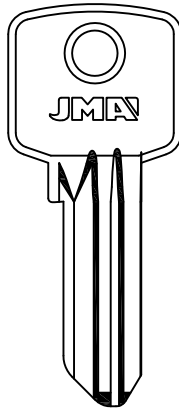
CAS-CISMA

LAT.

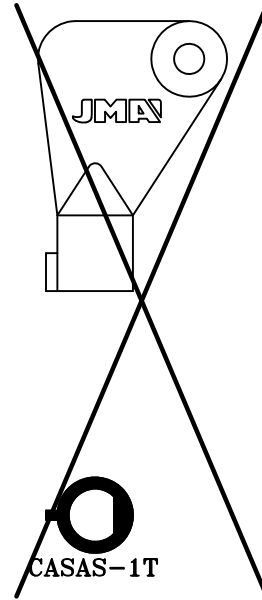
 KP2
 CIS-6D
 NEW
 CIS-7D
CASAS

CASAS-1T

PARA-FOR:

BURG (D)
 CAB (I)
 CAS-CISMA (I)
 CES (D)
 CINA (RC)
 CISA (I)

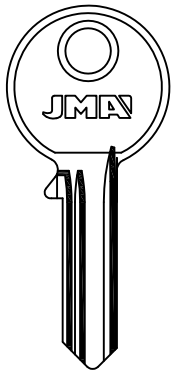
CES

LAT.

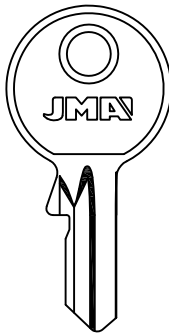
 WS 401-410
 CE-130

LAT.



CE-131D

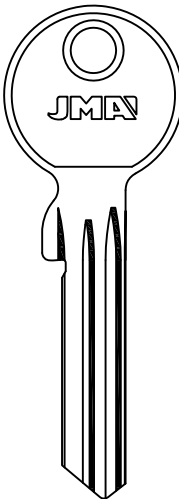

LAT.

27	CE-132/27	
26	CE-132/26	46
25	CE-132/25	45
18	CE-132/18	38
17	CE-132/17	37
16	CE-132/16	36
15	CE-132/15	35
		46
		45
		38
		37
		36
		35

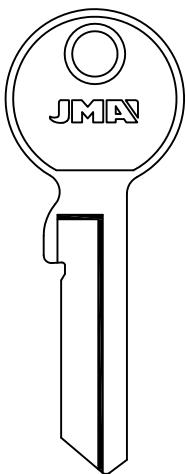
CES

CE-134

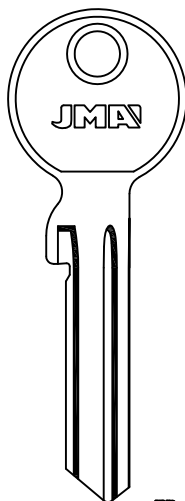

ALP.

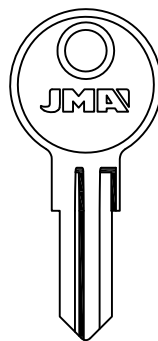
 TB
 CE-135D
CINA

CIN-1 CIN-1D

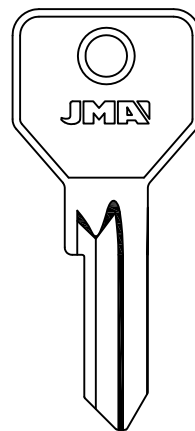
CISA

CI-62D



PARA-FOR: CISA

CISA (I)
CORBIN (I)
DIERRE (I)
DOM (D)

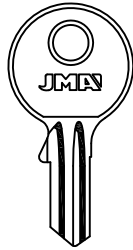

CI-65

ABUS-ALA

LAT.

ALU.
COL.
** FSH.
* LAT.
ABUS
ESCO
ESSENDIA
GEFI
GETE
GTV
NB
SCHUCO
STANDARD

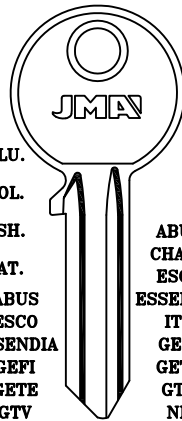

CI-11D

ABUS
CHAVO
ESCO
ESSENDIA
ITO
GEFI
GETE
GTV
NB
SCHUCO
STANDARD
TREE

CI-2I	A CI-2	CI-34	NEW CI-34D
20 CI-9D	02 CI-8D	CI-36	
04-05-07 CI-11D	08 CI-10D	CI-38D	
33 CI-13	11 CI-12	CI-42	
CI-15	CI-15D	CI-53	NEW * CI-66D
CI-18	CI-16D		NEW CI-64D
19 CI-29	CI-27		NEW CI-63
** CI-DL			NEW CI-63D

CORBIN

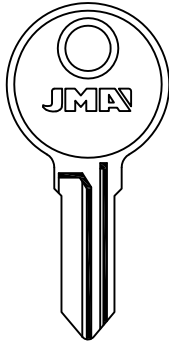

NEW
COR-24 COR-24D

CHANGE-O-MATIC

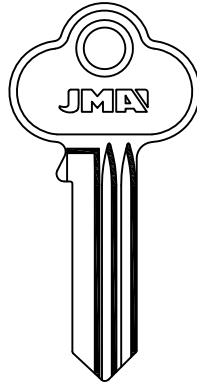

COR-62

LAT.

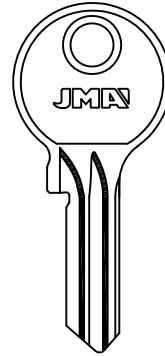

COR-115D

LAT.

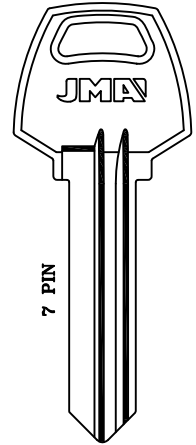

GRM
COR-153

7 PIN

BLACK & DECKER

DIERRE

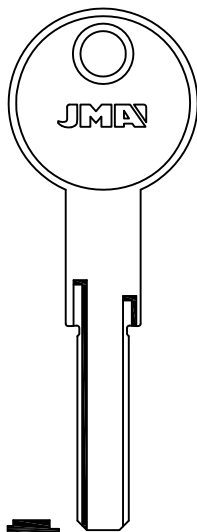

DR-1

ATRA

LAT.

DOM

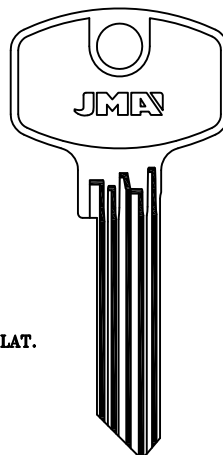

LAT.

DOM-27/35

DOM-27/19

DOM-27/16

DOM-27/13

DOM-27/12

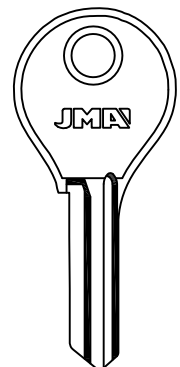

NEW
DOM-28 DOM-28D



DOM

PARA-FOR:

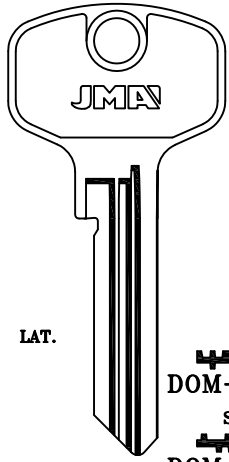

LAT.

DOM-58D

S

DOM-54D

C

DOM-53D

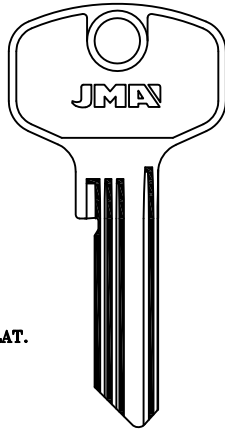

LAT.

DOM-65 DOM-67D

DOM-61 DOM-60D

DOM-59 DOM-57D

DOM-55 DOM-55D

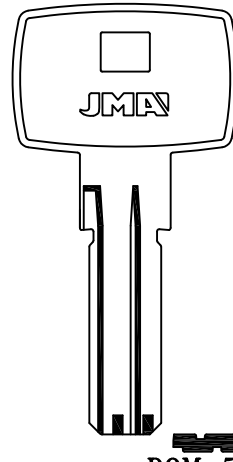

ALP.

DOM-56D

DOM-63D

DOM (D)
ESS (D)
EUROLOCKS (B)
EVVA (A)

DOM

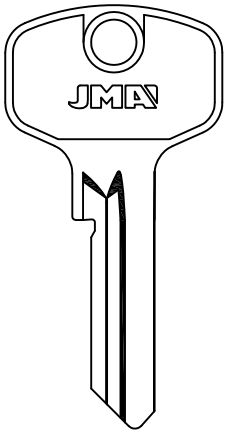

DOM-62D

STUV

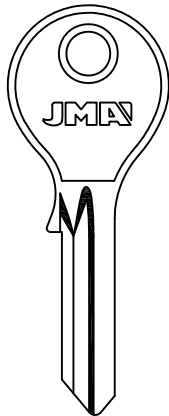

DOM-64D

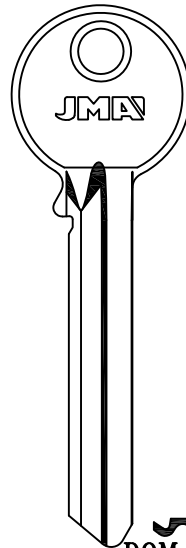

DOM-66D

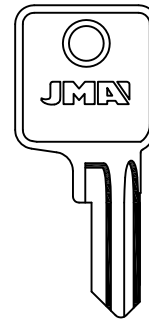

CL...1-250
GP...1-250
C...1001-1200
C...1301-1500

DOM-68

GEWIRU

ESS

EUROLOCKS

EVVA

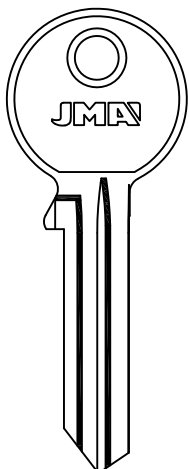

LAT.

ESS-9D

BAB

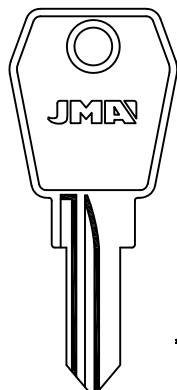

*ALU.

NEW
EU-13D

25001-27000

*EU-2

FASMA-L.&F.

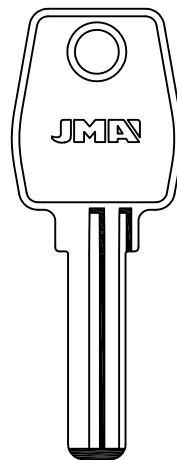

LAT.

7,6
2,9
EU-12

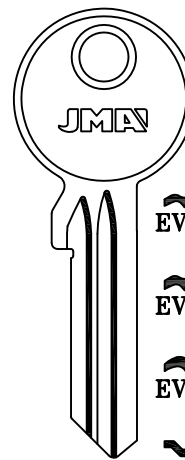

A
EV-6D

C
EV-7D

F
EV-8D

S
EV-9D

NEW
EV-23D

ELCA-TRYBA



PARA-FOR:

EVVA

EVVA (B)
 EXPRES (PL)
 FAC (E)
 FRIPA (D)
 FTH (F)
 GE GE (A)
 GERA (D)

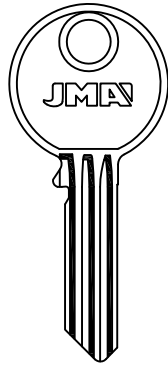

LAT.

NM...
 50000-54999

 EV-19

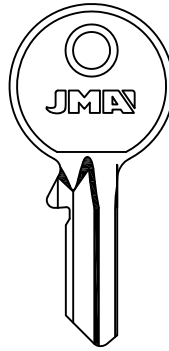

LAT.

...(K1) 4001-4250

 EV-20D

EXPRES

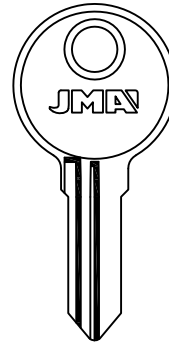

WTR

 EXS-3

RST

 EXS-2D

WT

 EXS-3D

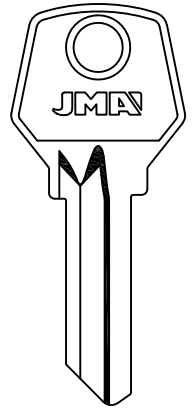

EXS-4D

SISO

EXPRES

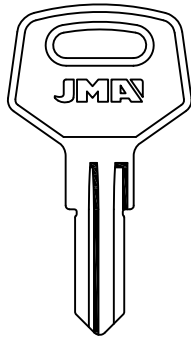

EXS-5

EXS-5D

EXS-6

SISO

FAC

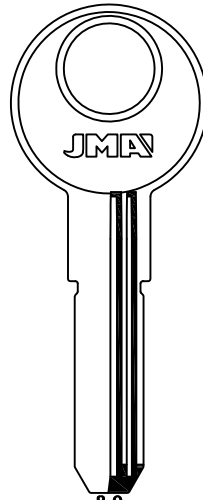

LAT.

FAC-24

FRIPA

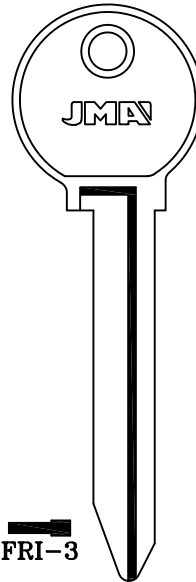

FRI-3

FTH

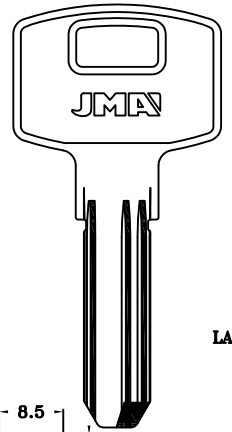

LAT.

FTH-25

NEW

 FTH-30

THIRARD

FTH

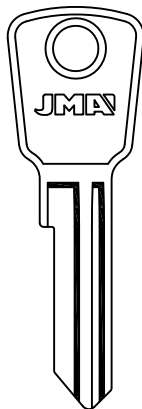

FTH-31

FEDERAL

GE GE

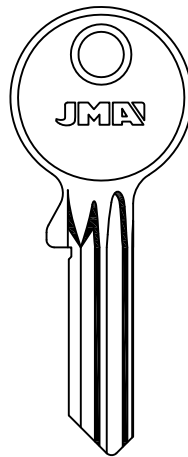

GE-21

GE-21D

GERA

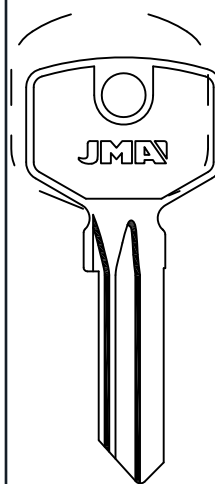

PZ6900

 GEA-6D

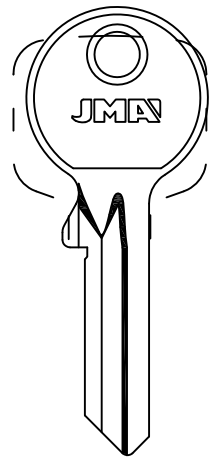

GEA-7D

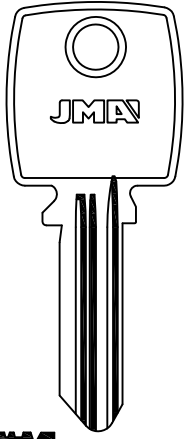

GTV

GTV-11

GTV-10

TIEFENTHAL

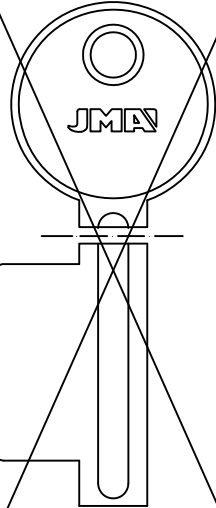
HECTOR

HEC-1

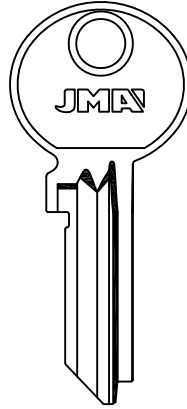
HTEC

HTE-1D

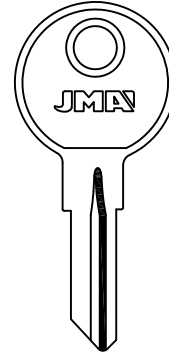
HUWIL

HUW-2

PARA-FOR:

GTV (D)
 HTEC (E)
 HUWIL (D)
 IKON (D)

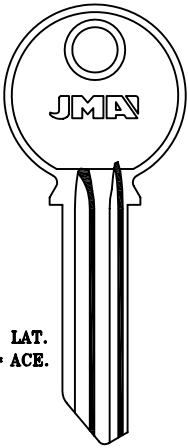
IKONLAT.
* ACE.

ZE-40D	ZE-41	ZE-78D	ZE-79	ZE-86D	ZE-93D	ZE-100	ZE-120
ZE-38	ZE-39	ZE-76D	ZE-77D	ZE-85	ZE-92D	ZE-99	ZE-119D
ZE-36D	ZE-37D	ZE-74	ZE-75	ZE-84	ZE-91D	ZE-98	ZE-118
ZE-21D	ZE-22	ZE-72	ZE-73	ZE-83	ZE-90	ZE-97D	ZE-104D
ZE-19	ZE-20	ZE-46	ZE-71D	ZE-82	ZE-89	ZE-96D	ZE-103
ZE-17D	ZE-18D	ZE-44D	ZE-45D	ZE-81	ZE-88	ZE-95D	ZE-102
* ZE-8	ZE-15	ZE-16D	ZE-42	ZE-43	ZE-80	ZE-87	ZE-94D

ZE-131 ZE-140

ZE-130 ZE-139D

ZE-129D ZE-138

ZE-128 ZE-137

ZE-124 ZE-135D

LAT.

ZE-123D ZE-134 ZE-144D

ZE-122D ZE-133D ZE-143

ZE-121D ZE-132D ZE-142

JMA[®]

Copyright by Alejandro Altuna S.A. 2012



ATENCIÓN: Concerniente a las marcas y denominaciones comerciales ver nota en índice.
 ATTENTION: Concerning the marks and commercial denominations see note in index.
 ATTENTION: Concernant les marques et dénominations commerciales voir la note dans l'index.
 ACHTUNG: Beziehen auf die marke und handelsname sehen sie die notiz im index.

PARA-FOR: IKON

IKON (D)
ILS (I)

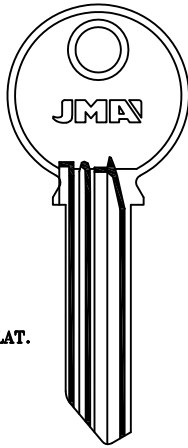

ZE-65D	ZE-66D	ZE-67D	ZE-68D	ZE-69D	ZE-110D	ZE-117D
ZE-60D	ZE-61D	ZE-62D	ZE-63D	ZE-64D	ZE-109D	ZE-116D
ZE-55D	ZE-56D	ZE-57D	ZE-58D	ZE-59D	ZE-108D	ZE-115D
ZE-50D	ZE-51D	ZE-52D	ZE-53D	ZE-54D	ZE-107D	ZE-114D
ZE-33D	ZE-34D	ZE-47D	ZE-48D	ZE-49D	ZE-106D	ZE-113D
ZE-28D	ZE-29D	ZE-30D	ZE-31D	ZE-32D	ZE-105D	ZE-112D
ZE-23D	ZE-24D	ZE-25D	ZE-26D	ZE-27D	ZE-70D	ZE-111D

ZE-147D

ZE-146D

ZE-145D

ZE-141D

ZE-136D

LAT.

ZE-127D

ZE-126D

ZE-125D ZE-148D

PERFIL Z SERIE 400

IKON

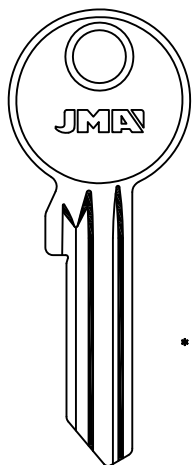

SN4 ZE-1	SN3 ZE-1D
SN2 ZE-2	SN1 ZE-2D
N2 ZE-6	N1 ZE-6D
	M ZE-9D

NEW SN5
* ZE-14D

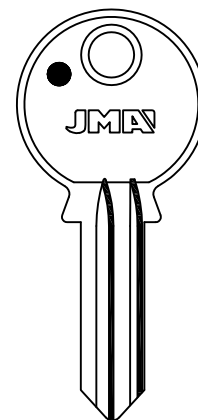

DS1
ZE-35

DS2
ZE-35D

BRUMME-OTIS

ILS

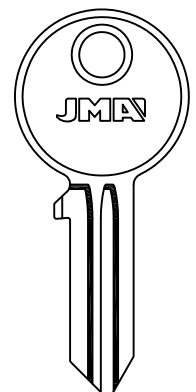

ILS-1



ISEO

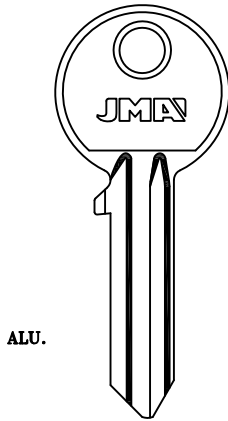

ALU.



IS-4

....1-2000
Y....1-2000
0 AL 8



IS-8



IS-5D



IS-7D



IS-8D



IS-18D



IS-19D



IS-3I



IS-3D

JARDI

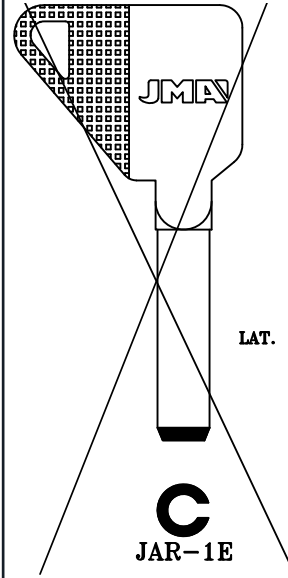

LAT.



JAR-1E

PARA-FOR:

- ISEO (I)
- JOWIL (D)
- JPM (F)
- KESO (CH)
- KFV (D)
- LINCE (E)
- LITTO (B)

JOWIL

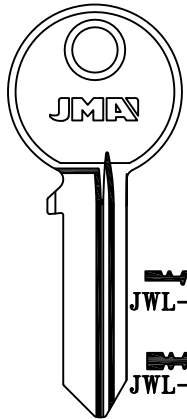

GTV



JWL-1D



JWL-3D



JWL-4D



JWL-9



JWL-9D

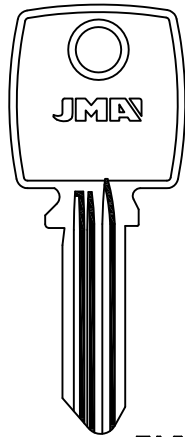

LAT.



JWL-10D



JWL-11D

JPM

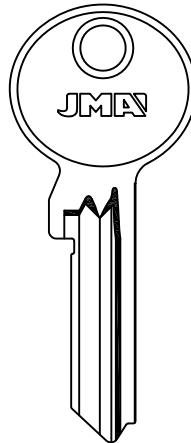

JPM-10D

KESO

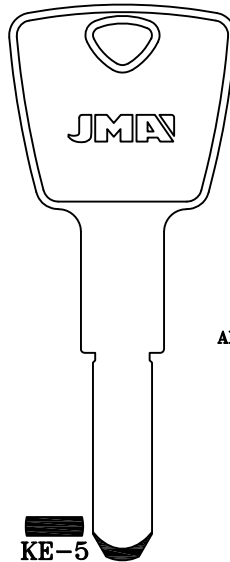

ALP.



KE-5

KFV

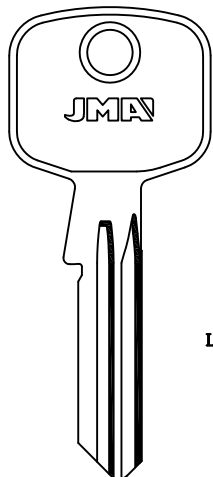

LAT.



KFV-0



KFV-N



KFV-M



KFV-L



KFV-F



KFV-E



KFV-D



KFV-C

COMBA-FCV-FLIETHER-GIESCHE
GOTZ-GRAF-HSA-NICO-SCHUCCO-SEN

LINCE

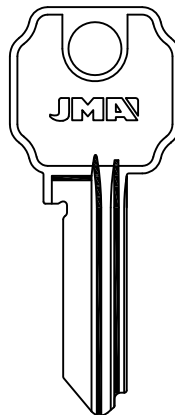

LIN-25



LIN-25D

LITTO

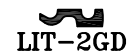
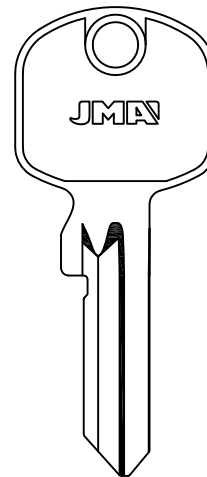

LIT-2GD



PARA-FOR:

L&F

L&F (GB)
 LT (PRC)
 MAGNUM
 MCM (E)
 MLM (F)
 MUL.T.LOCK (IL)
 RUKO (DK)
 SERRALLER (E)

.....35000-35499
78000-78999
79000-79999



LF-21

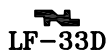

LF-33D



NEW
 LF-43

LT

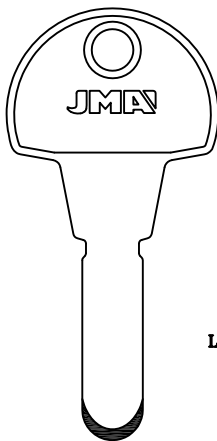

LAT.

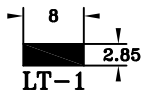

LT-1

MAGNUM

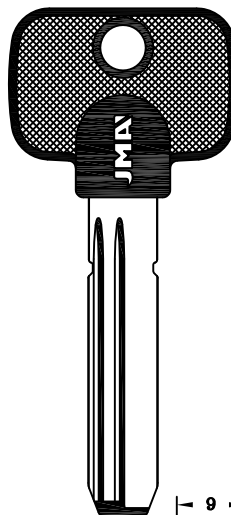

ALP.

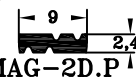

MAG-2D.P1

MCM

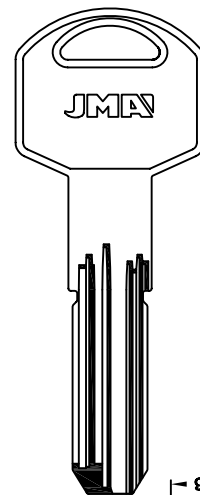

LAT.

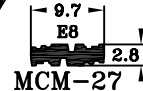

MCM-27

MLM

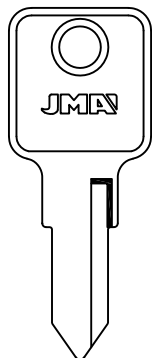

MLM-2

NEW
 MLM-5 MLM-5D

DOM-STUV

MUL.T.LOCK

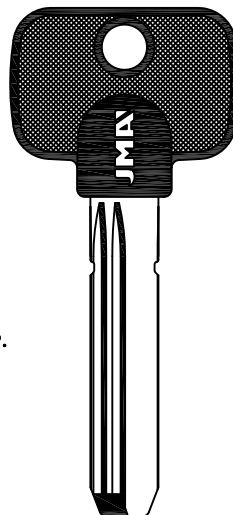

ALP.

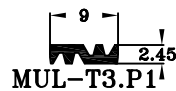

MUL-T3.P1

64
NEW
 MUL-T8.P1

NEW
 MUL-T9.P1

JUNIOR
NEW
 MUL-T11.P1

GAMMA

RUKO

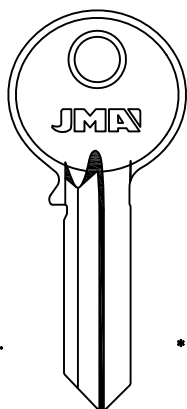

ALU.

* LAT.

.....1 AL 8
1 AL 9
1 AL 9 AL 0 A-B
0 AL 9 A AL M
 S.....1 AL 9



RU-1D

DIFA



RU-2I



RU-2D



RU-3D



RU-4D



RU-10D



NEW
 * RU-19D



RU-TL

SERRALLER

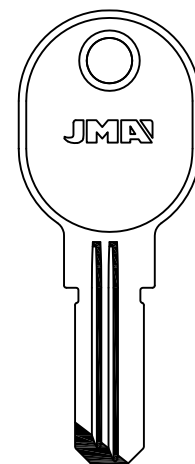

LAT.



SER-3D



STEM

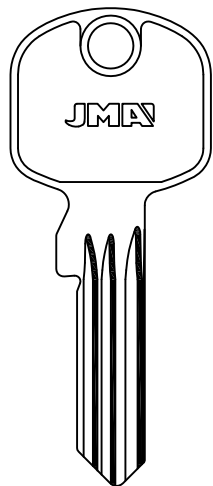

 STE-8D

 STE-7

 STE-6

 STE-5D

 STE-4

 STE-3

 STE-1

 STE-2D

NEW
 STE-14D

NEW
 STE-13D

 STE-12

 STE-11

 STE-10

 STE-9D

GE GE

STUV

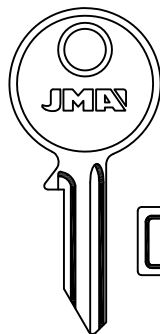

1F...201-278

1F...Z201-278

1F...X201-278

2F...

201-278

 STUV-1I  STUV-1D

9F

NEW
 STUV-3

DOM-MLM

TECON

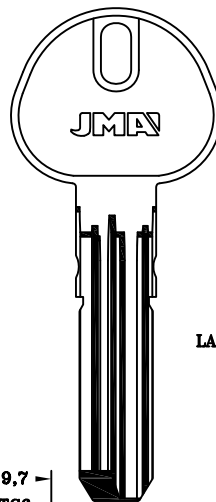

LAT.

9,7
TC6
2,8
TC-1

PARA-FOR:

STEM (D)
STUV (D)
TECON (E)
TITAN (SLO)
TOK WINKHAUS (D)

TITAN

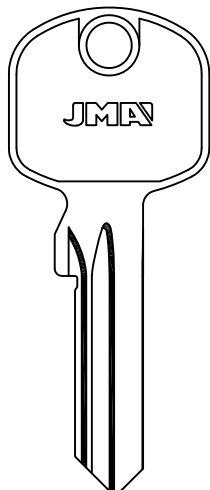

 TIT-2GD

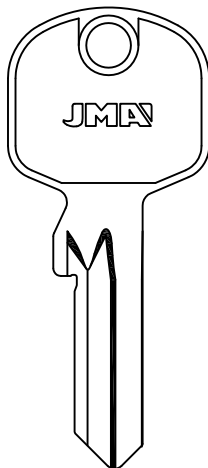

 TIT-8GD

TOK WINKHAUS

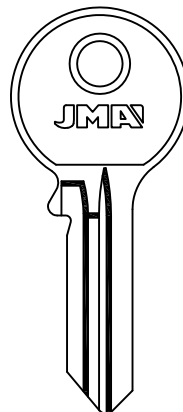

LAT.

 TOK-56D

TRELOCK

TOK WINKHAUS

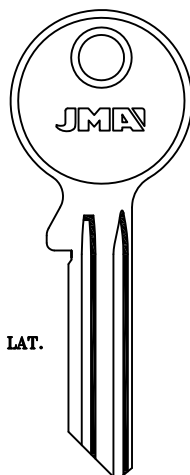

LAT.

 TOK-75

 TOK-61

 TOK-60

 TOK-59

 TOK-78

 TOK-58

 TOK-77

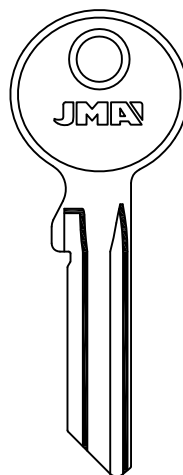

LAT.

 TOK-76

SERIE AZ 01 N

JMA[®]

Copyright by Alejandro Altuna S.A. 2012



ATENCIÓN: Concerniente a las marcas y denominaciones comerciales ver nota en índice.
ATTENTION: Concerning the marks and commercial denominations see note in index.
ATTENTION: Concernant les marques et dénominations commerciales voir la note dans l'index.
ACHTUNG: Beziehen auf die Marke und Handelsname sehen sie die Notiz im Index.

PARA-FOR: TOK WINKHAUS

TOK WINKHAUS
(D)
TRELOCK (D)
TSAG (E)
UNIVERSAL

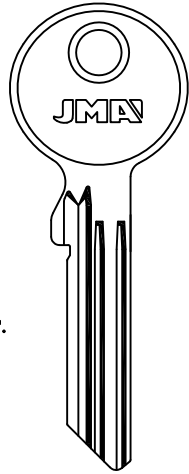

LAT.

- | | | | | | | | |
|-------------------------|--------------------------|--------------------------|--------------------------|--------------------------|---------------------------|--------------------------|--------------------------|
| NEW X7
TOK-37 | NEW X6
TOK-62 | NEW X6
TOK-62D | NEW X14
TOK-40 | X13
TOK-8 | X12
TOK-39 | X11
TOK-38 | X18
NEW TOK-69 |
| NEW X5
TOK-47 | NEW X5
TOK-47D | NEW X4
TOK-21 | NEW X4
TOK-21D | NEW X10
TOK-48 | NEW X10
TOK-48D | NEW X17
TOK-68 | NEW X16
TOK-41 |
| NEW X3
TOK-46 | NEW X2
TOK-45 | NEW X2
TOK-45D | NEW X9
TOK-67 | NEW X8
TOK-63 | NEW X15
TOK-49 | | |
| NEW X1
TOK-44 | NEW X1
TOK-44D | | | | | | |

SERIE X

TOK WINKHAUS

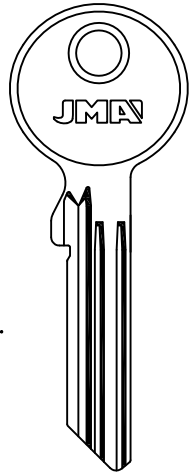

LAT.

- | | | | | | | | | | | | | | | | | | |
|-------------------------|-------------------------|-------------------------|-------------------------|-------------------------|-------------------------|-------------------------|---------------|--------------------------|--------------------------|--------------------------|--------------------------|-------------------------|-------------------------|--------------------------|--------------------------|--------------------------|--------------------------|
| NEW Y7
TOK-52 | NEW Y6
TOK-43 | NEW Y5
TOK-51 | NEW Y4
TOK-70 | NEW Y3
TOK-22 | NEW Y2
TOK-42 | NEW Y1
TOK-50 | Y14
TOK-24 | Y13
NEW TOK-72 | Y12
NEW TOK-66 | Y11
NEW TOK-64 | Y10
NEW TOK-54 | Y9
NEW TOK-53 | Y8
NEW TOK-71 | Y18
NEW TOK-74 | Y17
NEW TOK-65 | Y16
NEW TOK-55 | Y15
NEW TOK-73 |
|-------------------------|-------------------------|-------------------------|-------------------------|-------------------------|-------------------------|-------------------------|---------------|--------------------------|--------------------------|--------------------------|--------------------------|-------------------------|-------------------------|--------------------------|--------------------------|--------------------------|--------------------------|

SERIE Y

TRELOCK

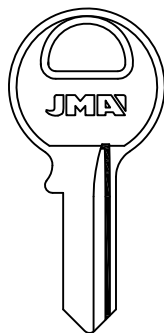

TRL-2
HAMPTON

TSAG

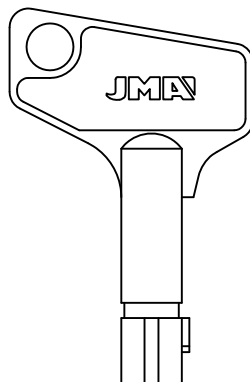

J
SAG-1T
NEW DESIGN
NUEVO DISEÑO

UNIVERSAL

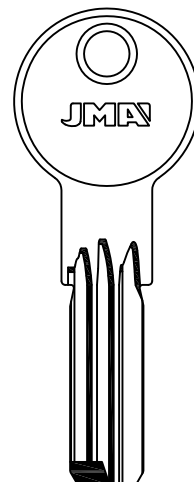

TX-2
ISEO

LAT.

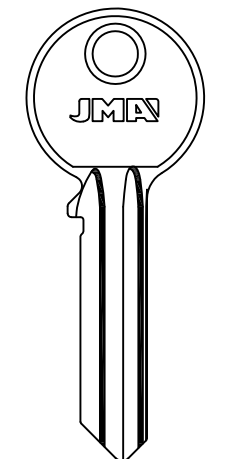

U-26 U-26D



VIRO

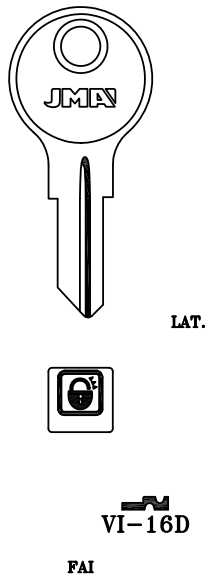
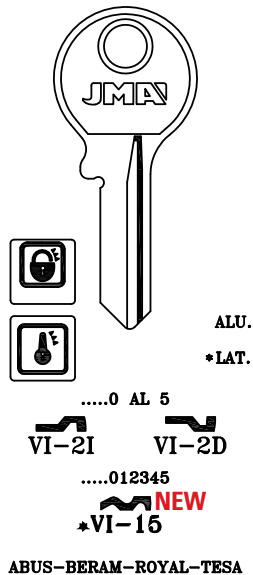

WELKA

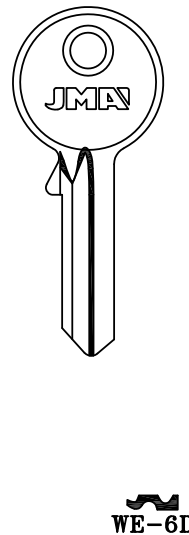

PARA-FOR:

VIRO (I)
WELKA (I)
WILKA (D)
WINLOCK (GB)
YALE (D-GB-USA)

WILKA

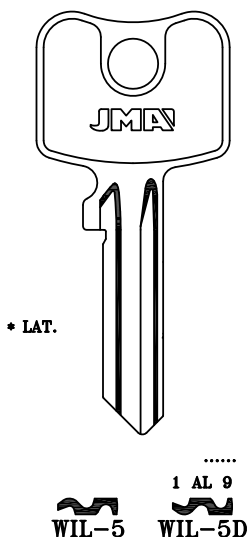

* WIL-26	* WIL-33D	* WIL-40D	* WIL-48D	* WIL-55	NEW
* WIL-25	* WIL-32	* WIL-39D	* WIL-47D	* WIL-54	
W101 * WIL-24	* WIL-31D	* WIL-38D	* WIL-46D	* WIL-53	
* WIL-19D	* WIL-30	* WIL-37D	* WIL-45D	* WIL-52	
* WIL-18	* WIL-29	* WIL-36D	* WIL-44	* WIL-51D	
* WIL-9	* WIL-28	* WIL-35D	* WIL-43D	* WIL-50D	
* WIL-8	* WIL-27	* WIL-34D	* WIL-41D	* WIL-49D	* WIL-56

WINLOCK

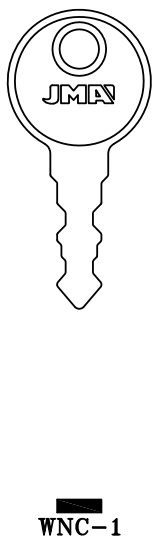

YALE

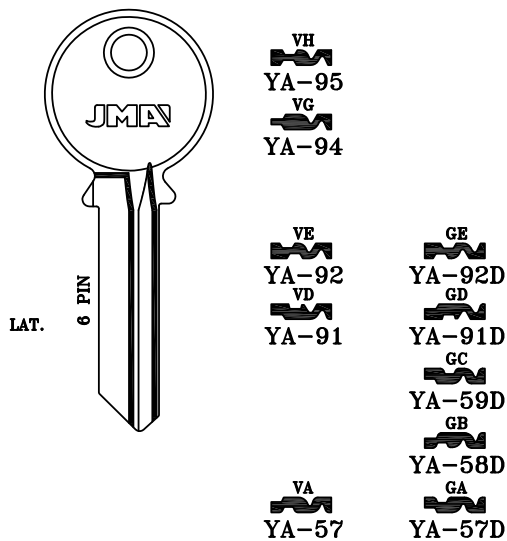

PARA-FOR: YALE

YALE
(D-GB-USA)

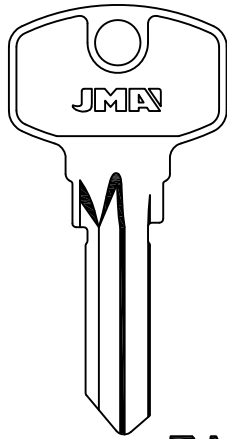

YA-79D

NEW

YA-272D

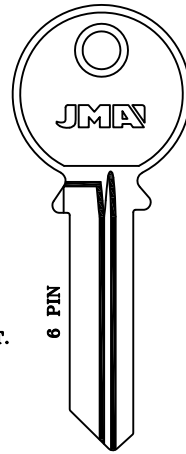

LAT.

6 PIN

LG
YA-103D

LF
YA-102D

LE
YA-101D

LD
YA-100D

LC
YA-99D

LB
YA-98D

LA
YA-97D

YALE

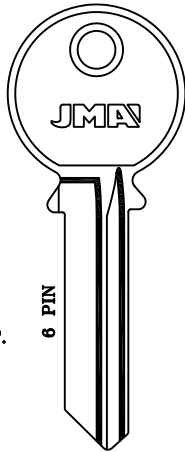

LAT.

6 PIN

YG
YA-113

YF
YA-112

YE
YA-111

YB
YA-108

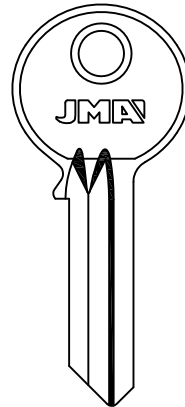

LAT.

YA-142D

BKS

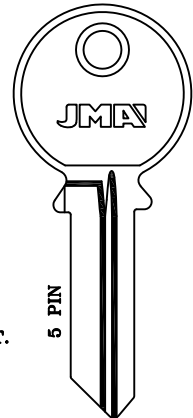

LAT.

5 PIN

GA
YA-186D

YALE

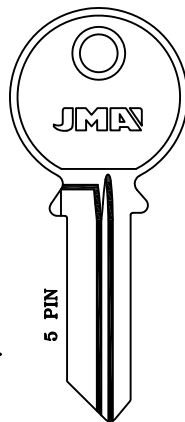

LAT.

5 PIN

LG
YA-212D

LE
YA-210D

LD
YA-209D

LC
YA-208D

LA
YA-206D

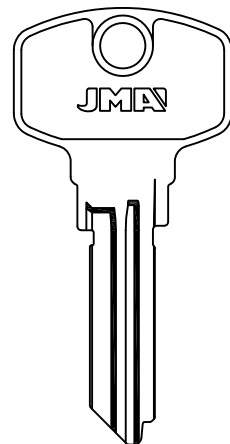

KTM
YA-273D



YALE (D-GB-USA)
 YARDENI (IL)
 YUN HUAN (PRC)
 YWS (TW)

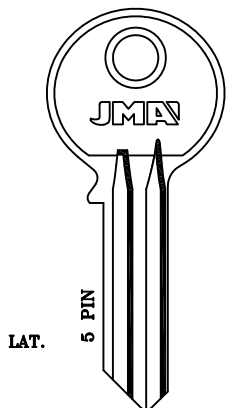

- VF
YA-221
- VE
YA-220
- VD
YA-219
- VB
YA-217
- VA
YA-216

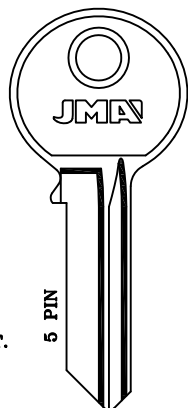

- YH
YA-232
- YE
YA-229
- YD
YA-228
- YC
YA-227
- YB
YA-226
- YA
YA-225

BKS

BKS

YADERNI

YUN HUAN

YWS

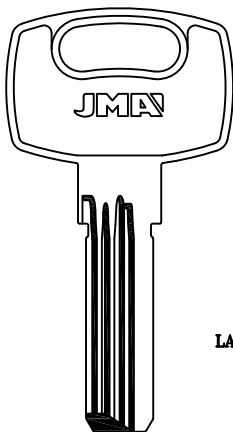

YAR-3

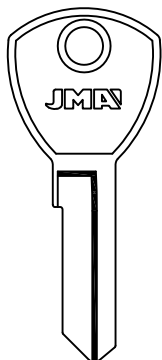

YUH-1D

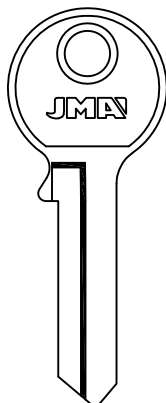

YUH-2D

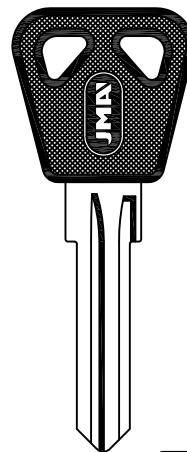

YW-1.P

ABUS



LLAVES PARA VEHÍCULOS

IBILGAILUENTZAKO GILTZAK

KEYS FOR VEHICLES

CLÉS POUR VÉHICULES

FAHRZAUGESCHLÜSSEL



THE KEY TO EXCELLENCE
GLOBALLY UNLOCKING MILLIONS OF DOORS DAILY

PARA-FOR:

B&S

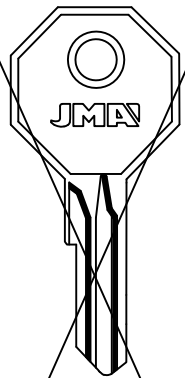

BS-3D

BOSCH

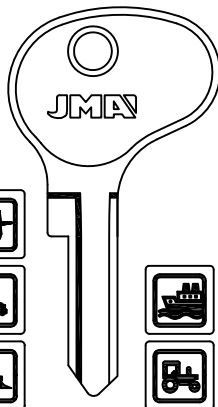

MS-S
1-50
BH-8

KOLB-LAPORTE

BURG

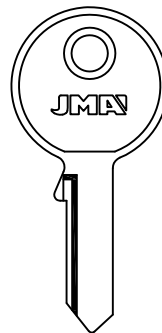

BUR-30D

MOFA

DAEWOO

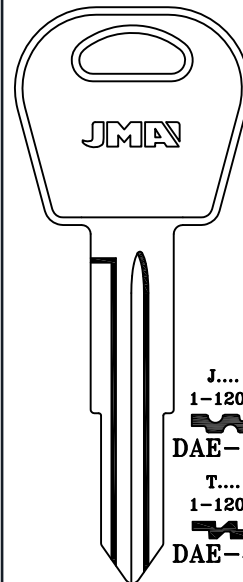

J...
1-1200
DAE-3D
T...
1-1200
DAE-4D

- BOSCH (D)
- BURG (D)
- DAEWOO (K)
- FLORA (D)
- GEWU
- GHE (D)
- HARLEY DAV.
(USA)
- HONDA (J)
- HUF (D)

FLORA

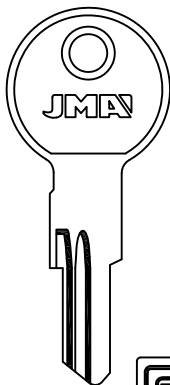

903-979
1-9 00-80
FLO-2D

RUNO

GEWU

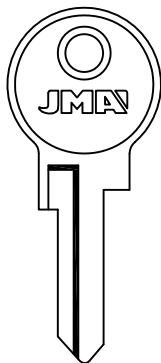

GW-1D

ZUNDAPP

GHE

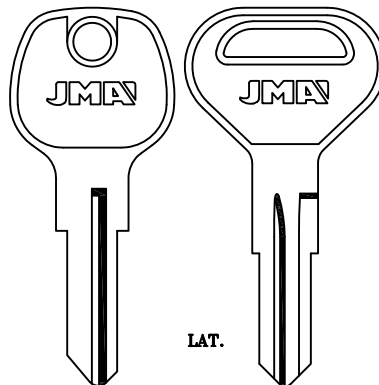

LAT.



GY
25-90
GH-2

LS 378-816
GH-3

PEROHAUS-POS-WECO

KASSBOHRER

HARLEY DAV.

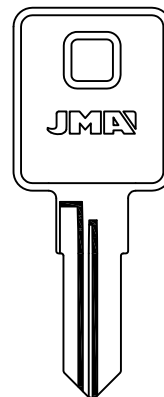

HD-4D

HONDA

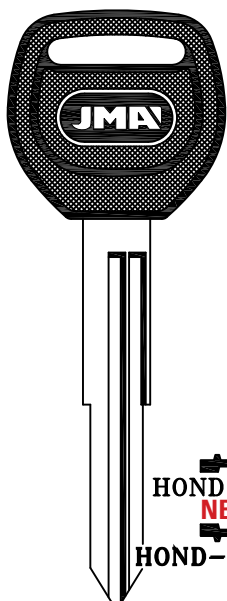

HOND-24.P
NEW
HOND-24D.P

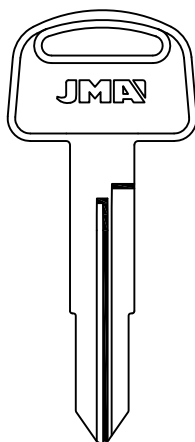

A..00-99
HOND-43 HOND-43D

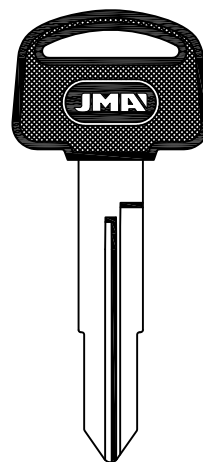

A..00-99
HOND-43.P HOND-43D.P

HUF

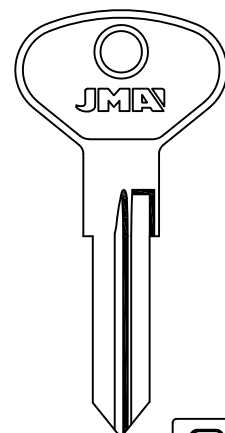

NW...
1-51
HU-NW

BOSCH

JMA®

Copyright by Alejandro Altuna S.A. 2012

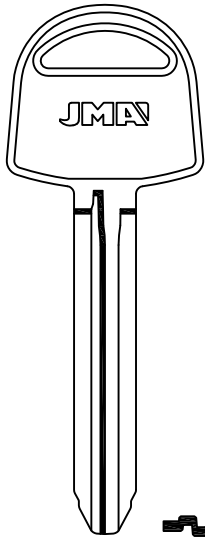

ATENCIÓN: Concerniente a las marcas y denominaciones comerciales ver nota en índice.
ATTENTION: Concerning the marks and commercial denominations see note in index.
ATTENTION: Concernant les marques et denominations commerciales voir la note dans l'index.
ACHTUNG: Beziehen auf die marke und handelsname sehen sie die notiz im index.

ISUZU

ISU-3D

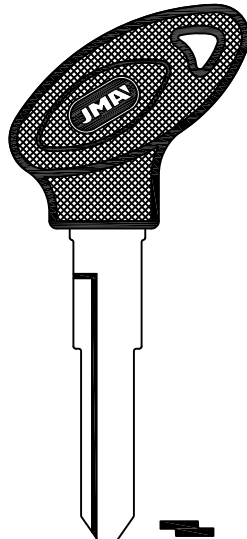
MONDIAL

MOD-1D.P

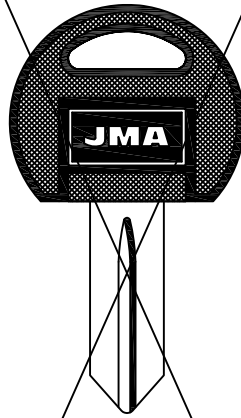
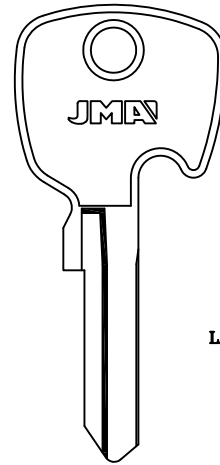
NEIMANNE-21.P
VOLVO
FASTEXD...
1-2-3-4-5
NE-61D**PARA-FOR:**

ISUZU (J)
MONDIAL (F)
NEIMAN (F)
TOYOTA (J)
TRW-SIPEA (I)
YWS (TW)
ZADI (I)

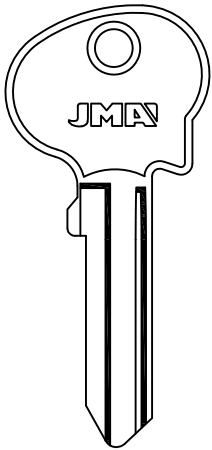
NEIMAN

LAT.

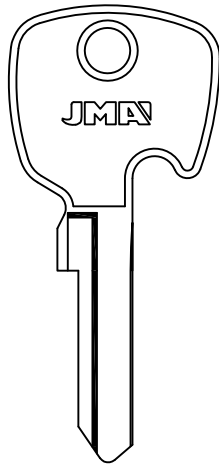
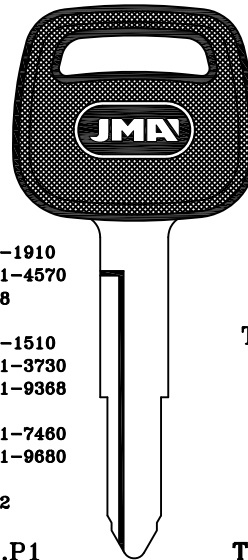
B...
1-2-3-4-5
NE-62M...
1-2-3-4-5
NE-63D**TOYOTA**

K...
001-400/1511-1910
2221-2620/3731-4570
5001-6368
R...
401-800/1112-1510
2621-3020/3331-3730
5001-6924/8001-9368
S...
5951-6350/7061-7460
8171-8570/9281-9680
D...
6001-7042
TOYO-12.P1

F...
5951-6350
7061-7460
8171-8570
9281-9680
P...
7001-8500
TOYO-13.P1

C...
6001-8042
U...
3001-4000
Z...
1-1000
TOYO-12D.P1

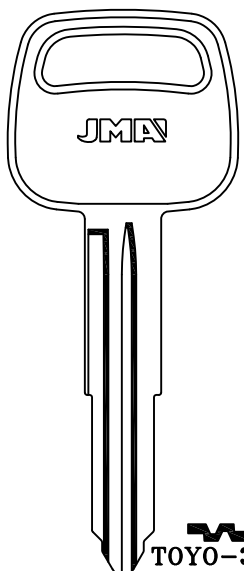
TOYOTA
TOKAJ-RIKA**TOYOTA**

TOYO-37D

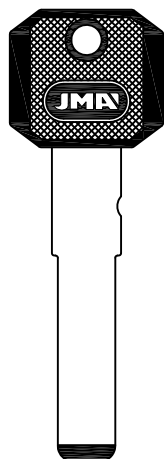
TRW-SIPEA

LAT.

FI-16.P1

GIOBERT

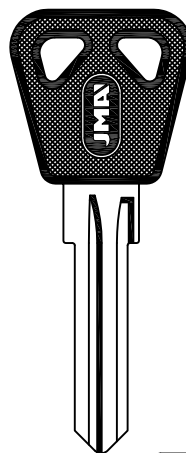
YWS

YW-1.P

ABUS

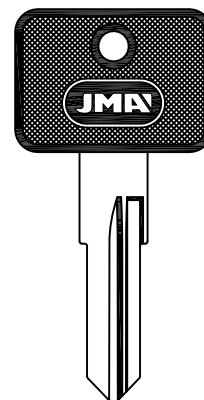
ZADI

ZA-5.P

NEW
ZA-5D.P**JMA**

Copyright by Alejandro Altuna S.A. 2012



ATENCIÓN: Concerniente a las marcas y denominaciones comerciales ver nota en índice.
ATTENTION: Concerning the marks and commercial denominations see note in index.
ATTENTION: Concernant les marques et dénominations commerciales voir la note dans l'index.
ACHTUNG: Beziehen auf die Marke und Handelsname sehen sie die Notiz im Index.

LLAVES DE CRUZ-GORJA-ARMARIO
GURUTZE-GORJA-ARMAIRUETARAKO GILTZA
CRUCIFORM-BIT -FURNITURE KEYS
CLÉS CRUCIFORMES-GORGES- POUR MEUBLES
KREUTZSCHLÜSSEL-CHUBBSCHLÜSSEL-MOBELSCHÜSSEL



THE KEY TO EXCELLENCE
GLOBALLY UNLOCKING MILLIONS OF DOORS DAILY

PARA-FOR:

BLUMA

BLUMA (D)
MP
CISA (I)
CR (I)
CRONOS

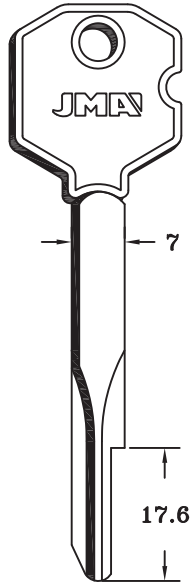

+
BLU-2X

BOINAITI

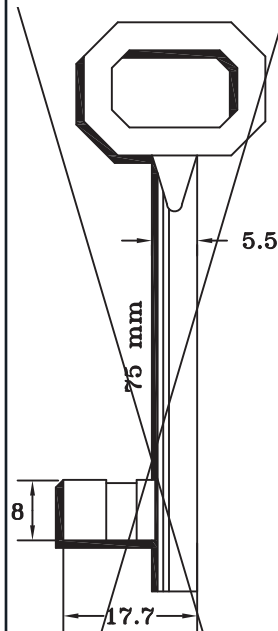

BON-2G

MP

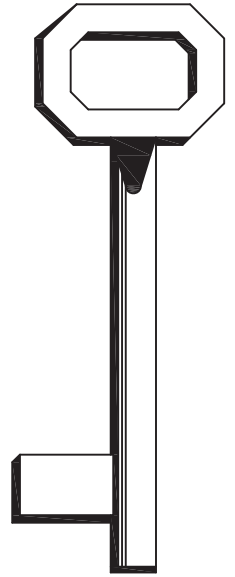

MPA-1G

CISA

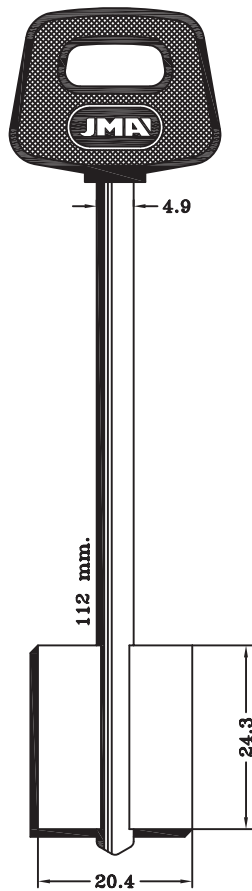

CI-3PG

CR

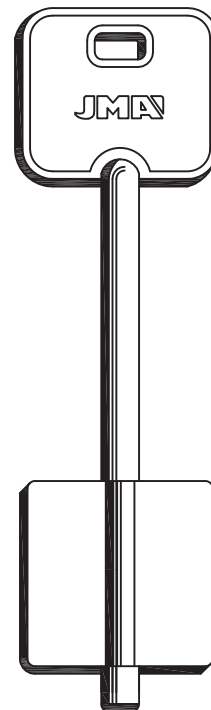

CR-19G

CRONOS

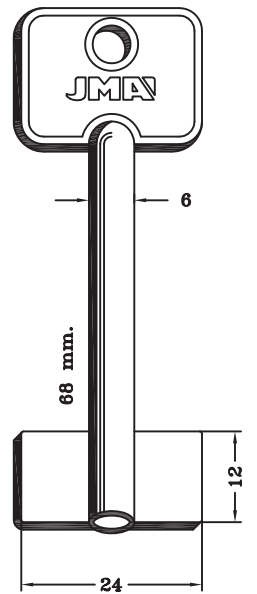

CR0-1G



MOTTURA

PARA-FOR:

MOTTURA (I)

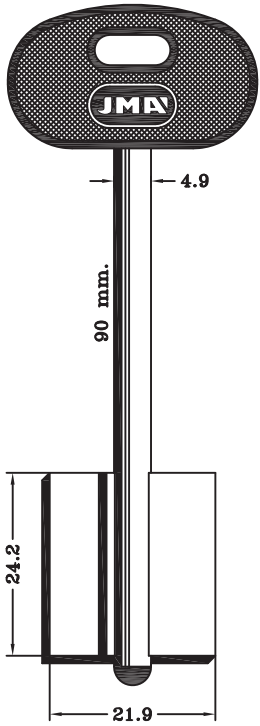

MT-3P1G

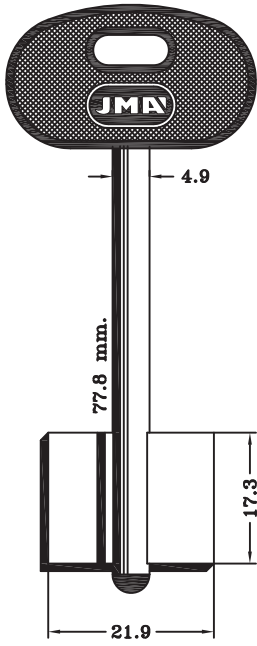

MT-5P1G

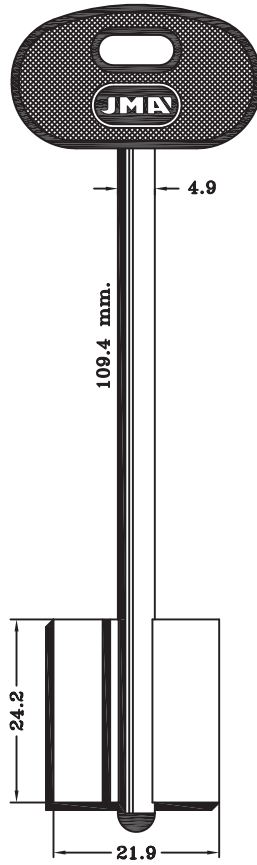

MT-10P1G
MT-6P1G

MOTTURA

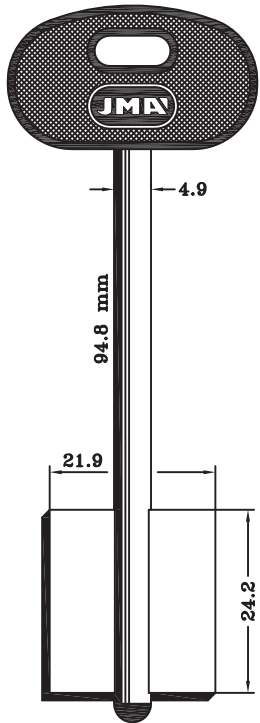

MT-9P1G

MT-8P1G

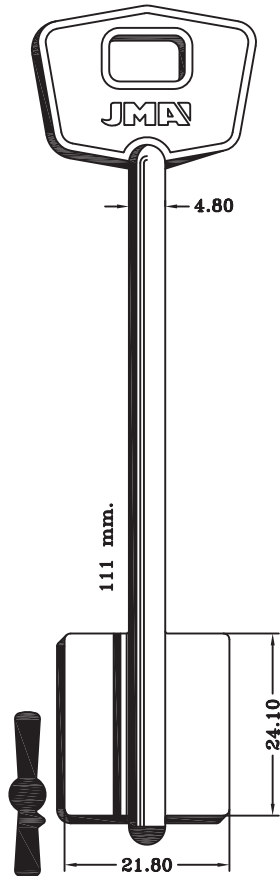

MT-18G



PARA-FOR:

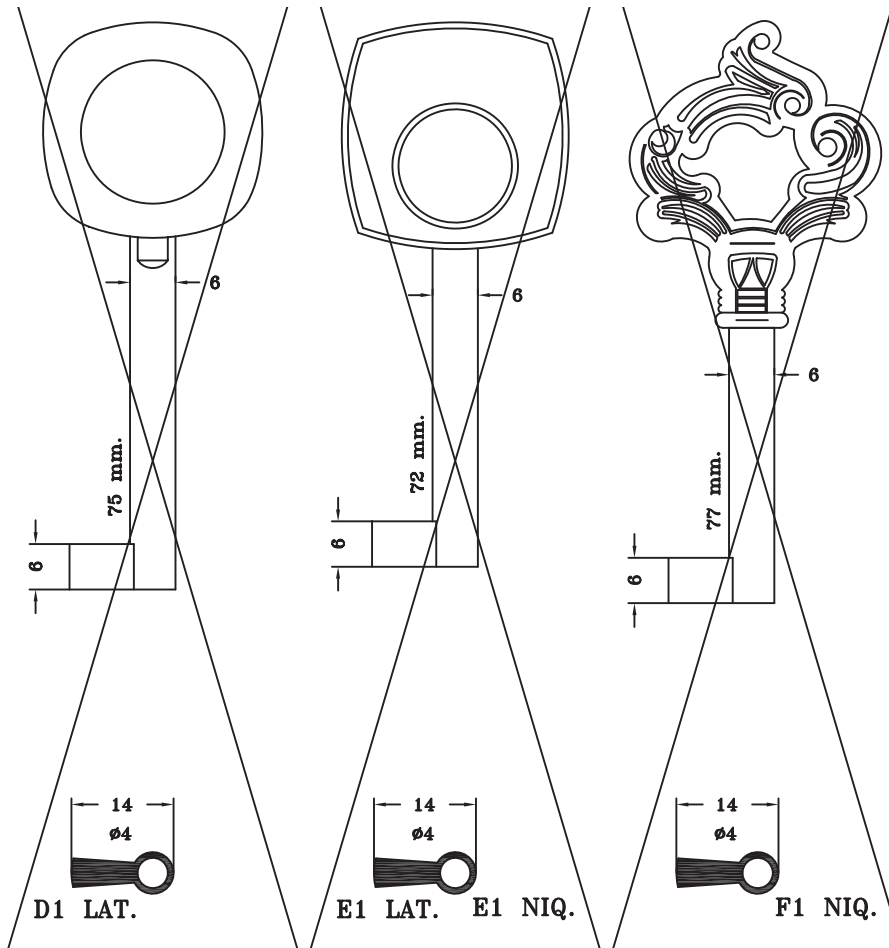

ESPECIALISTA
SPECIALIST

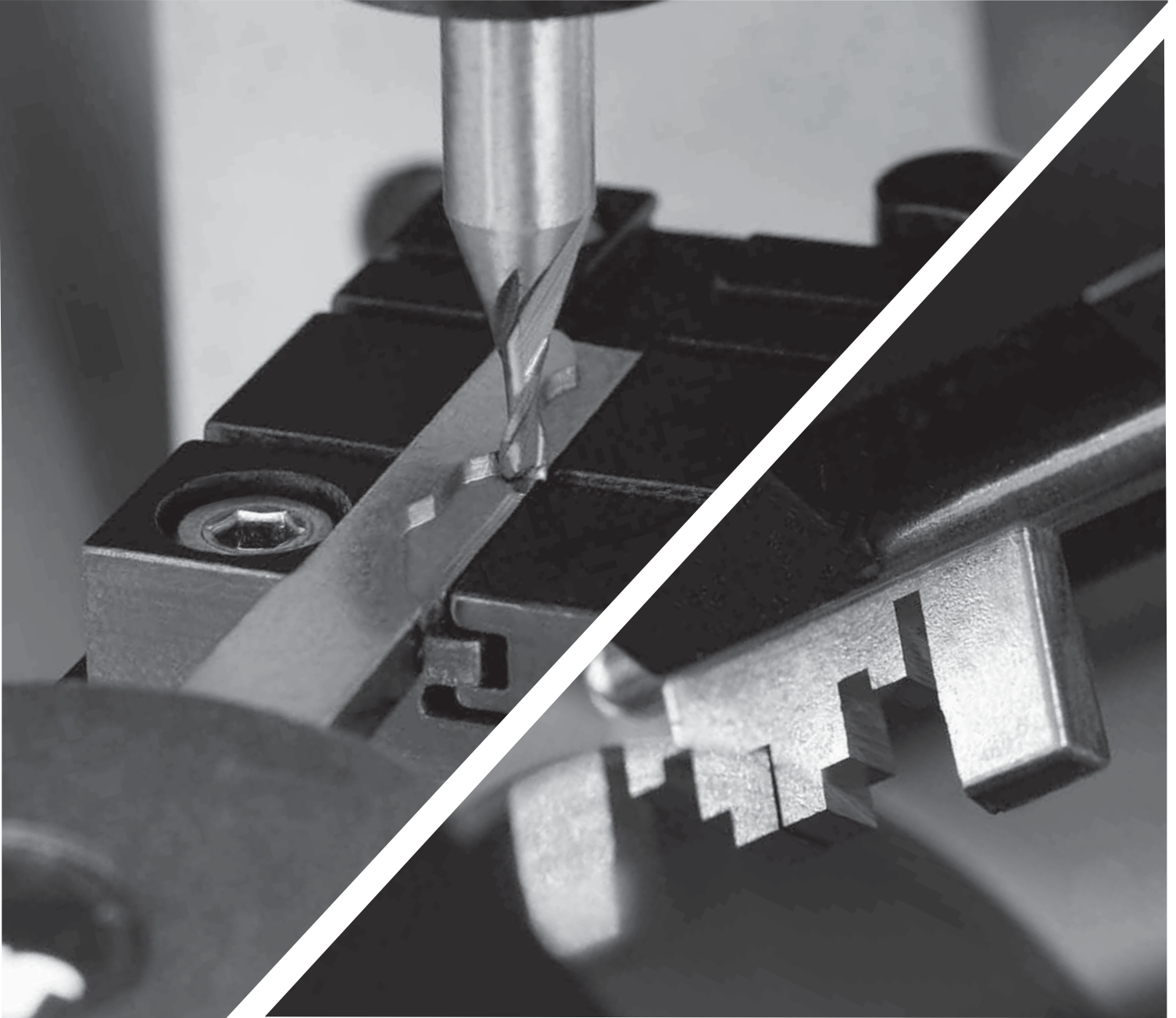

SUPLEMENTO-SUPPLEMENT 2011.C10

THE KEY TO EXCELLENCE
GLOBALLY UNLOCKING MILLIONS OF DOORS DAILY

FRESAS

FRESAK
MILING CUTTERS
FRAISES
FRÄSE

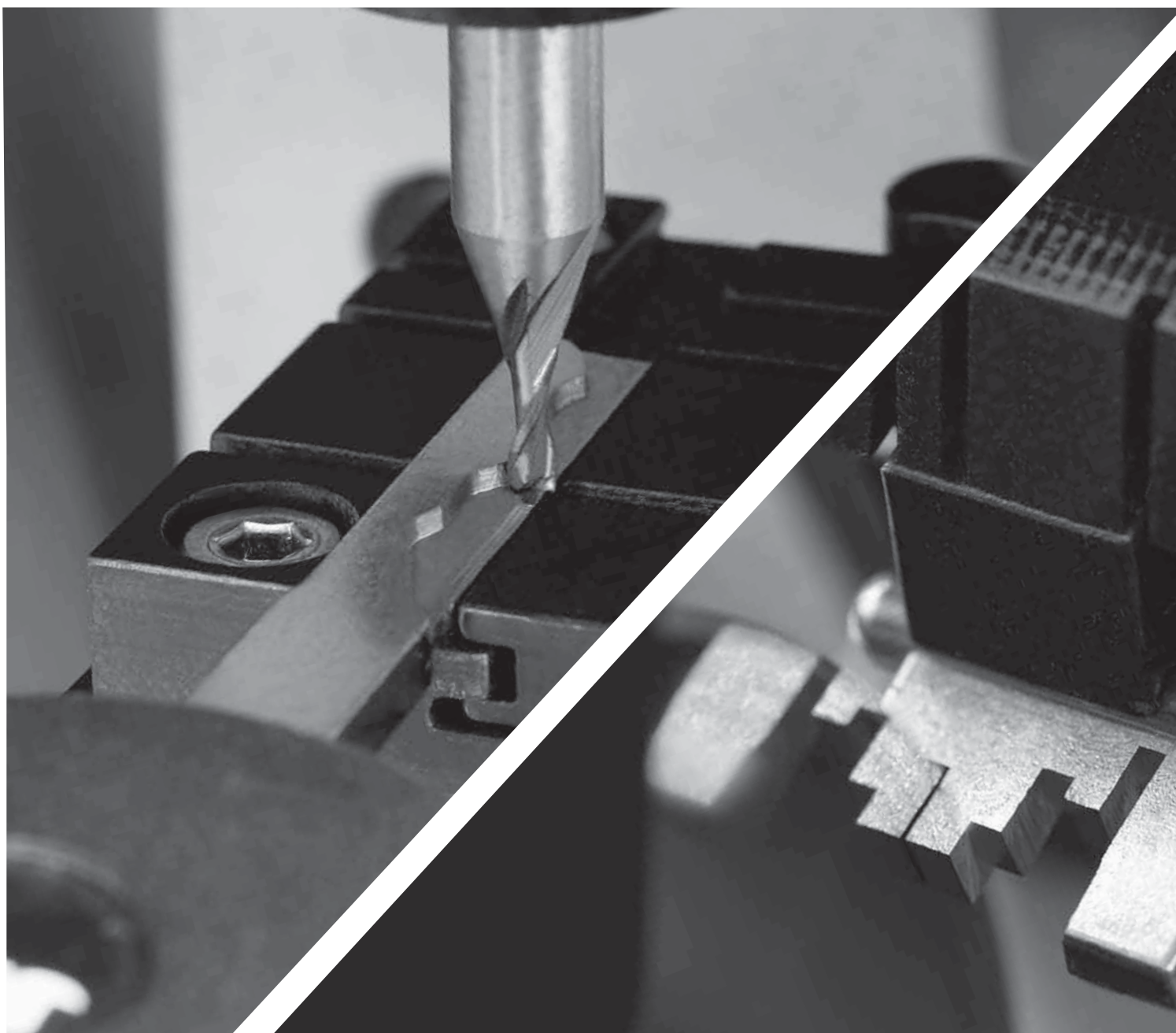

THE KEY TO EXCELLENCE
GLOBALLY UNLOCKING MILLIONS OF DOORS DAILY

CEPILLOS

ESKUILA-BRUSH-BROSSES-BÜRSTE

CODE	AxB	PARA-FOR
C1	60x10	BOSTON
C2	75x10	CE-2
C3	80x13	DAKOTA-DAKOTA-EXTRA-
C4	80x10	DAKOTA ANTIGUA-NEVADA-KANSAS-DENVER
C5	100x13	SARATOGA-YAKARTA
C6	65x13	ECCO-PLUS, ECCO-BIT
C7	75x13 (Nylon)	PROCODE - SENNA - VIENNA

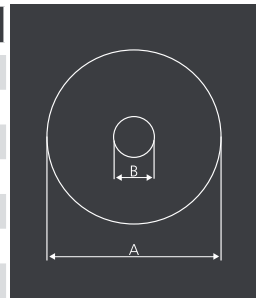

FRESAS

FRESAK-MILING CUTTERS-FRAISES- FRÄSE

CODE	AxB		PARA-FOR	MAT.
FP7	63x1,25x16	lateral	ECCO BIT-DETROIT	HSS
FP8	63x1,4x16	lateral	ECCO BIT-DETROIT	HSS
FP9	63x1x16		ECCO BIT	HSS
FP10	63x2,4x16		ECCO FORD-ECCO ABLOY-PASADENA-NEBRASCA	HSS
FP17	80x1,25x16	lateral	SARATOGA-YAKARTA-TITAN-BIT	HSS
FP18	80x1,25x22	lateral	ATLANTA-TOPEKA	HSS
FP19	80x1,4x16	lateral	SARATOGA-YAKARTA-TITAN-BIT-DAKOTA G	HSS
FP20	80x1,4x22	lateral	ATLANTA-TOPEKA	HSS
FP21	80x1,5x22	lateral	DUPLEX-ATLANTA-TOPEKA-KANSAS	HSS
FP21W	80x1,5x22	lateral	DUPLEX-ATLANTA-TOPEKA-KANSAS	W
FP22	80x1x16		SARATOGA-DAKOTA G-TITAN BIT	HSS
FP23	80x1x22		DUPLEX-ATLANTA-TOPEKA	HSS
FP26	80x1,5x16		SARATOGA-YAKARTA-DAKOTA-G-SENNA	HSS
FP26W	80x1,5x16		SARATOGA-YAKARTA-DAKOTA-G-SENNA	W
FP27W	70x2,4x16			W
FP28W	70x1,7x16			W
FP31	80x1,6x16		SARATOGA-DAKOTA G-TITAN BIT	HSS

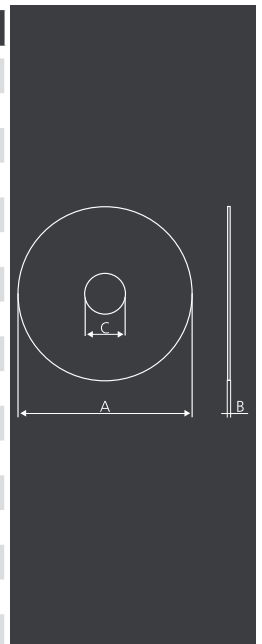

CODE	AxBxC	D	E	PARA-FOR	MAT.
FP1	25x10x10	50	0	OREGON	HSS
FP2W	40x6x10	35	0,1	VIRGINIA	W
FP3	50x6x12	45	0,15	KIS	HSS
FP4	53x6,3x12	45	0,1	KIS	HSS
FP5	57x5x12,7	45	0,15	JMA	HSS
FP6	60x5x12,7	42	0,1	SPRINT	HSS
FP11	63x5x16	42	0,15	ECCO-ECCO PLUS-ECCO AUTOMATIC	HSS
FP12	63x5x16	40	0,1	TUCSON	HSS
FP13	63x5x16-150D	42	0,1	DALLAS	HSS
FP14	70x13x7	45	0	LINCE CE-2	HSS
FP15	70x13x7-110	55	0	LINCE CM-1	HSS
FP16	70x5,25x16	40	0,1	PROCEDURE	HSS
FP16W	70x5,25x16	40	0,1	PROCEDURE	W
FP24	80x5x16	42	0,15	DAKOTA EXTRA-SARATOGA-NEVADA-DENVER-TITAN-TITAN MASTER-VIENNA	HSS
FP25	80x5x16,30	42,3	0,15	LINCE CA-3	HSS
FP41	80x8x16	50	1,2	CODE - ADAPTER DAKOTA EXTRA-SARATOGA-TITAN-TITAN MASTER-VIENNA	HSS
FP42	80x8x16	45	0,85	CODE - ADAPTER DAKOTA EXTRA-SARATOGA-TITAN-TITAN MASTER-VIENNA	HSS
FP43	80x8x16	45	1,55	CODE - ADAPTER DAKOTA EXTRA-SARATOGA-TITAN-TITAN MASTER-VIENNA	HSS
FP44	80x8x16	52,5	0,15	CODE - ADAPTER DAKOTA EXTRA-SARATOGA-TITAN-TITAN MASTER-VIENNA	HSS
FP45	80x8x16	45	1	CODE - ADAPTER DAKOTA EXTRA-SARATOGA-TITAN-TITAN MASTER-VIENNA	HSS
FP49	80x8x16	45	0,4	CODE - ADAPTER DAKOTA EXTRA-SARATOGA-TITAN-TITAN MASTER-VIENNA	HSS
FP50	80x8x16	50	0,4	CODE - ADAPTER DAKOTA EXTRA-SARATOGA-TITAN-TITAN MASTER-VIENNA	HSS

CODE	A	B	C	D	E	PARA-FOR	MAT
F1	90	0,8		45	6	CAPRI-COLUMBIA-DAKAR-DAKKI-DAYTONA-XCODE	
F1A	90	0,8		45	8	CAPRI-COLUMBIA-DAKAR-DAKKI-DAYTONA-XCODE	HSS
F1W	90	0,8		45	6	CAPRI-COLUMBIA-DAKAR-DAKKI-DAYTONA-XCODE	W
F3			1,5	45	6	CAPRI-COLUMBIA-DAKAR-DAKKI-DAYTONA-XCODE	HSS
F3W			1,5	45	6	CAPRI-COLUMBIA-DAKAR-DAKKI-DAYTONA-XCODE	W
F5W	90	0,9		45	6	CAPRI-COLUMBIA-DAKAR-DAKKI-DAYTONA-XCODE	HSS
F5W	90	0,9		45	6	CAPRI-COLUMBIA-DAKAR-DAKKI-DAYTONA-XCODE	W
F6	106	1		45	6	CAPRI-COLUMBIA-DAKAR-DAKKI-DAYTONA-XCODE	HSS
F7	70	0,8		45	6	CAPRI-COLUMBIA-DAKAR-DAKKI-DAYTONA-XCODE	HSS
F8			4	45	6	CAPRI-COLUMBIA-DAKAR-DAKKI-DAYTONA-XCODE	HSS
F8W			4	45	6	CAPRI-COLUMBIA-DAKAR-DAKKI-DAYTONA-XCODE	W
F11			2,5	45	6	CAPRI-COLUMBIA-DAKAR-DAKKI-DAYTONA-XCODE	HSS
F11W			2,5	45	6	CAPRI-COLUMBIA-DAKAR-DAKKI-DAYTONA-XCODE	W
F12A	100	0,6		45	6	CAPRI-COLUMBIA-DAKAR-DAKKI-DAYTONA-XCODE	HSS
F12B	100-90	2,1-2,9		45	6	CAPRI-COLUMBIA-DAKAR-DAKKI-DAYTONA-XCODE	HSS
F14	100	1,45		45	6	CAPRI-COLUMBIA-DAKAR-DAKKI-DAYTONA-XCODE	HSS
F15 plantillas		2	5	45	6	CAPRI-COLUMBIA-DAKAR-DAKKI-DAYTONA-XCODE	HSS
F16	130	0,6		45	6	CAPRI-COLUMBIA-DAKAR-DAKKI-DAYTONA-XCODE	HSS

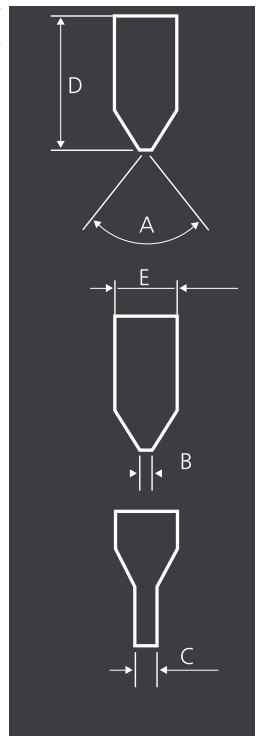
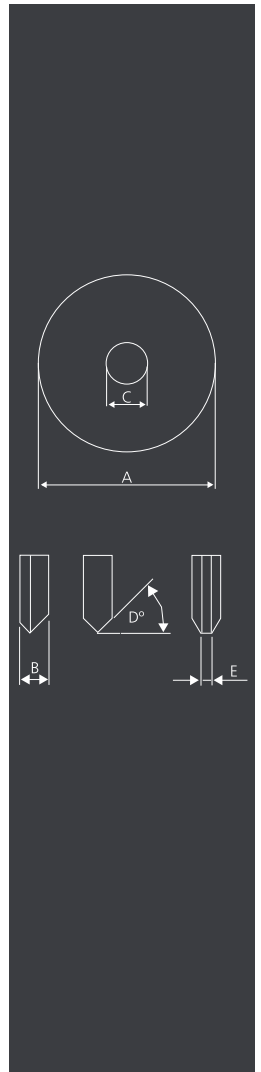

CODE	A	B	C	D	E	PARA-FOR	MAT
F17			3	45	6	CAPRI-COLUMBIA-DAKAR-DAKKI-DAYTONA-XCODE	W
F17W			3	45	6	CAPRI-COLUMBIA-DAKAR-DAKKI-DAYTONA-XCODE	W
F19	90	1,2		45	6	CAPRI-COLUMBIA-DAKAR-DAKKI-DAYTONA-XCODE	HSS
F19W	90	1,2		45	6	CAPRI-COLUMBIA-DAKAR-DAKKI-DAYTONA-XCODE	W
F21	85	0,72		45	6	CAPRI-COLUMBIA-DAKAR-DAKKI-DAYTONA-XCODE	HSS
F22			2,4	45	6	CAPRI-COLUMBIA-DAKAR-DAKKI-DAYTONA-XCODE	HSS
F23	90	0,8	3,3	45	6	CAPRI-COLUMBIA-DAKAR-DAKKI-DAYTONA-XCODE	HSS
F23W	90	0,8	3,3	45	6	CAPRI-COLUMBIA-DAKAR-DAKKI-DAYTONA-XCODE	W
F24	95	1		45	6	CAPRI-COLUMBIA-DAKAR-DAKKI-DAYTONA-XCODE	HSS
F24W	95	1		45	6	CAPRI-COLUMBIA-DAKAR-DAKKI-DAYTONA-XCODE	W
F25	95	1,1		45	6	CAPRI-COLUMBIA-DAKAR-DAKKI-DAYTONA-XCODE	HSS
F25W	95	1,1		45	6	CAPRI-COLUMBIA-DAKAR-DAKKI-DAYTONA-XCODE	W
F26	90	0,6	1,8	45	6	CAPRI-COLUMBIA-DAKAR-DAKKI-DAYTONA-XCODE	HSS
F27	90	0,7		45	6	CAPRI-COLUMBIA-DAKAR-DAKKI-DAYTONA-XCODE	HSS
F27W	90	0,7		45	6	CAPRI-COLUMBIA-DAKAR-DAKKI-DAYTONA-XCODE	W
F29W	100	0,6		45	6	XCODE	W
F30W	100	0,5		45	6	XCODE	W
F31W	90	0,6		45	6	XCODE	W
F32	90	0,6	3	45	6	CAPRI-COLUMBIA-DAKAR-DAKKI-DAYTONA-XCODE	HSS
F32W	90	0,6	3	45	6	CAPRI-COLUMBIA-DAKAR-DAKKI-DAYTONA-XCODE	W
F33			2	45	6	CAPRI-COLUMBIA-DAKAR-DAKKI-DAYTONA-XCODE	HSS
F33W			2	45	6	CAPRI-COLUMBIA-DAKAR-DAKKI-DAYTONA-XCODE	W
F34	90	1,4		45	6	CAPRI-COLUMBIA-DAKAR-DAKKI-DAYTONA-XCODE	HSS
F-35W	90	3	3	45	6	CAPRI-COLUMBIA-DAKAR-DAKKI-DAYTONA-XCODE	W
F43	90	0,7		45	6	CAPRI-COLUMBIA-DAKAR-DAKKI-DAYTONA-XCODE	HSS
FB	90- 90	2,7- 3,3		45	6	CAPRI-COLUMBIA-DAKAR-DAKKI-DAYTONA-XCODE	HSS
FC	80- 80			45	6	CAPRI-COLUMBIA-DAKAR-DAKKI-DAYTONA-XCODE	HSS
FBW	90- 90	2,7- 3,3		45	6	CAPRI-COLUMBIA-DAKAR-DAKKI-DAYTONA-XCODE	W
FCW	80- 80			45	6	CAPRI-COLUMBIA-DAKAR-DAKKI-DAYTONA-XCODE	W
F9			5,95	45	6	CHICAGO	HSS
F9W			5,95	45	6	CHICAGO	W

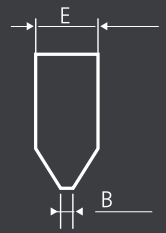
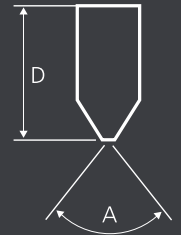

CODE	F	G	C	D	E	PARA-FOR	MAT
F18	10	1		45	6	CAPRI-COLUMBIA-DAKAR-DAKKI-DAYTONA-XCODE	HSS
F20	16	1,25		45	6	CAPRI-COLUMBIA-DAKAR-DAKKI-DAYTONA-XCODE	HSS
F36	12	2		45	6	XCODE	HSS
F37	12	1,3		45	6	XCODE	HSS

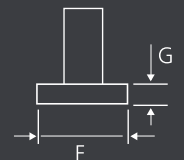

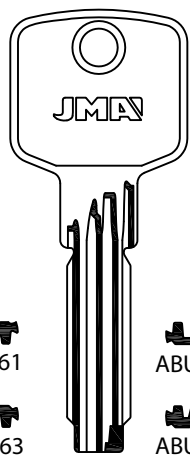

ABU-61



ABU-66



ABU-63



ABU-81

CAPRI-DAKAR- DAKAR EXPRESS

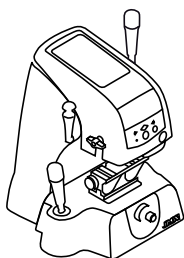

DAKKI

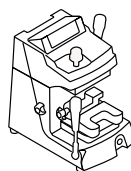

F1

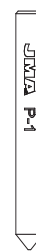

P1

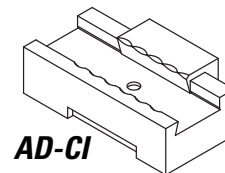

AD-CI

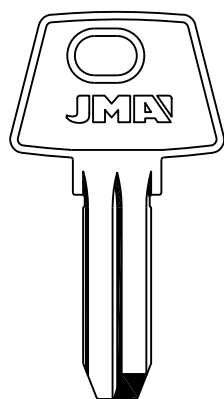

AGA-25

CAPRI-DAKAR- DAKAR EXPRESS

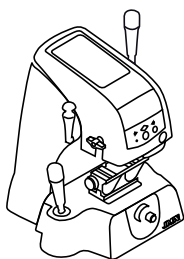

DAKKI

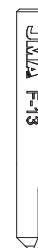
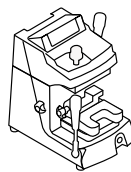

F13

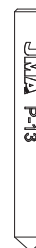

P13

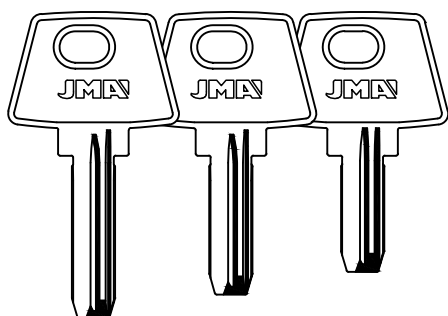

AGA-38

AGA-39

AGA-44

AGA-42

AGA-43

AGA-50

AGA-48

AGA-49

CAPRI-DAKAR- DAKAR EXPRESS

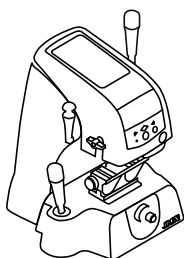

DAKKI

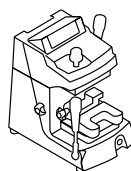

F1



P1

XCODE

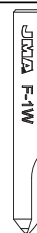
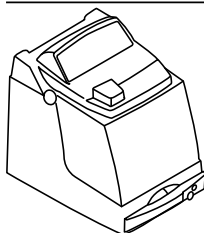

F1W

AGB

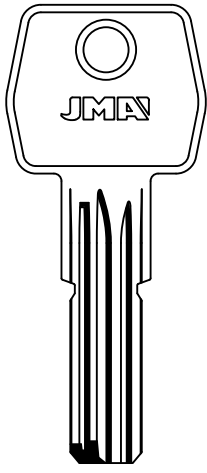

JMA
AGB-4

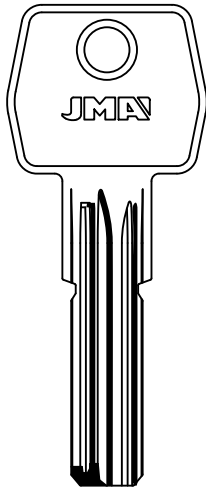

JMA
AGB-5

CAPRI-DAKAR-
DAKAR EXPRESS

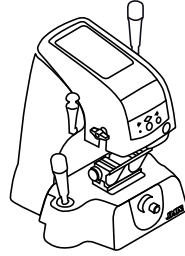

DAKKI

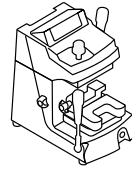

F1

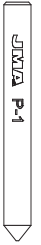

P1

AMIG

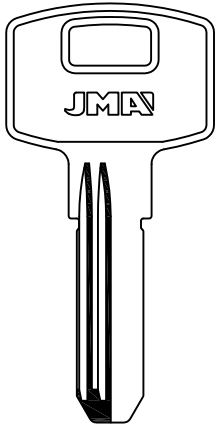

JMA
AMG-10D

CAPRI-DAKAR-
DAKAR EXPRESS

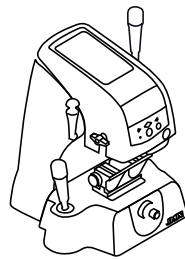

DAKKI

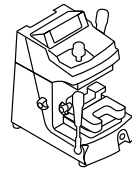

F5

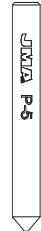

P5

APEX

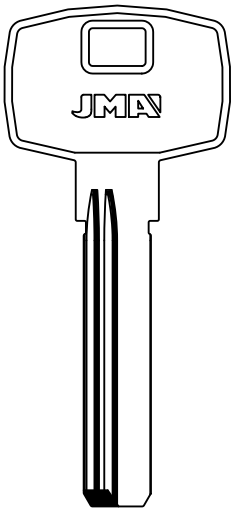

JMA
AP-4D

CAPRI-DAKAR-
DAKAR EXPRESS

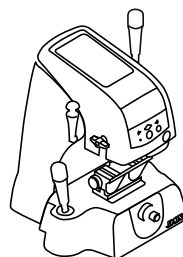

DAKKI

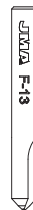
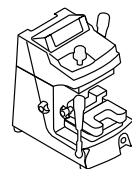

F13



P13

ASSA

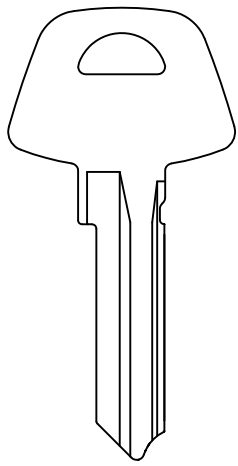

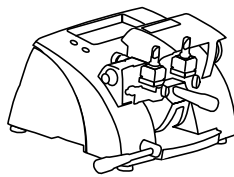

D12

VIENNA-DAKOTA EXTRA- TITAN MASTER-
ECCO/ECCO PLUS-ECCO AUTOMATIC

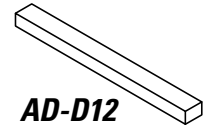
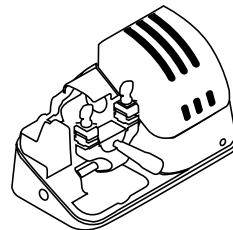
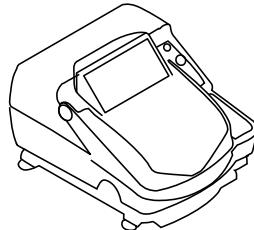

PROOCODE

ECCO-ECCO PLUS
ECCO AUTOMATIC



AD-D12

AXA

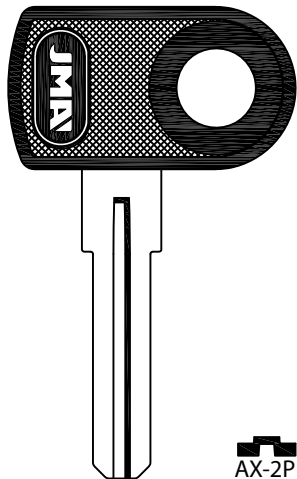

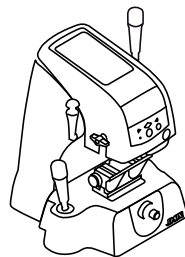

AX-2P

CAPRI-DAKAR-
DAKAR EXPRESS

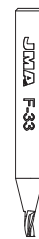
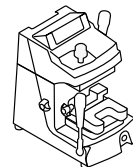

DAKKI



F33



P33

AZBE

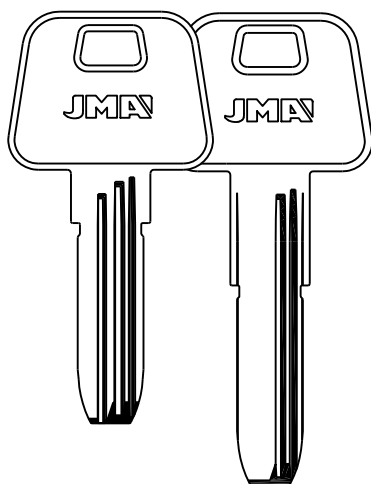



AZ-29

AZ-32

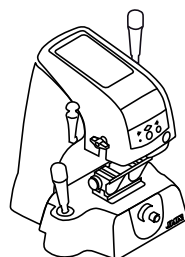
CAPRI-DAKAR-
DAKAR EXPRESS

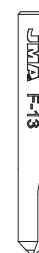
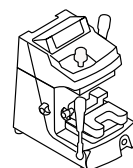

DAKKI



F13



P13

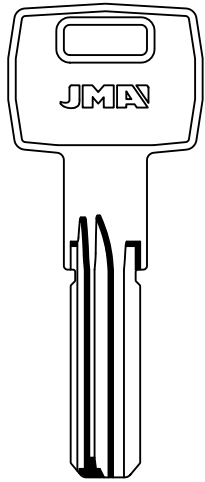

BASI
BAI-8D

CAPRI-DAKAR- DAKAR EXPRESS

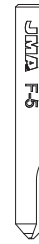
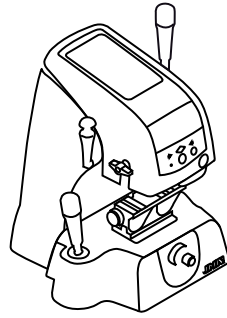

F5



P5

DAKKI

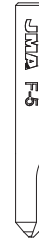
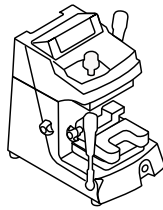

F5



P5

XCODE

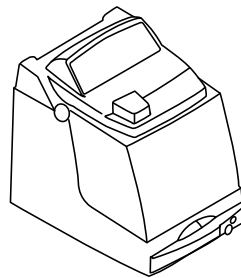

F19

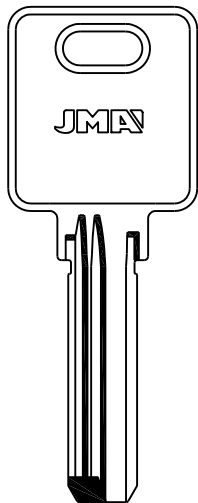

BEY
BEY-2D

CAPRI-DAKAR- DAKAR EXPRESS

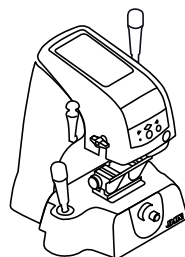

DAKKI

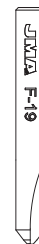
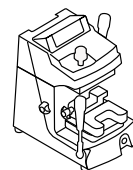

F19



P19

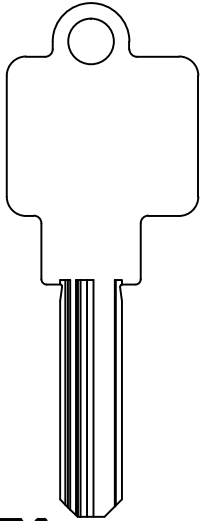

**WS 50 ORIGINAL
PROFILE NW**

*CAPRI-DAKAR-
DAKAR EXPRESS*

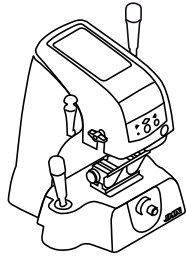

DAKKI

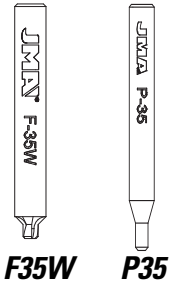
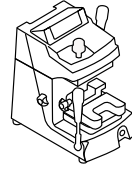

F35W P35

AD-BKS

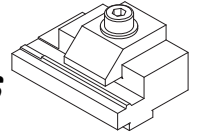

XCODE

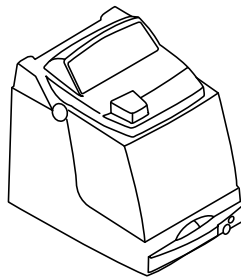

F35W

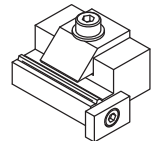

AD-X10

**WS 50 ORIGINAL
PROFILE RA-RK-RZ**

XCODE

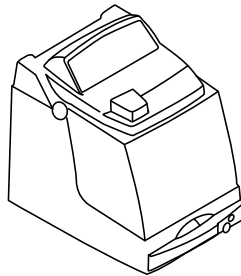

F35W

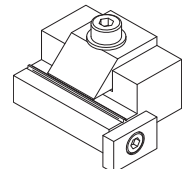

AD-X08

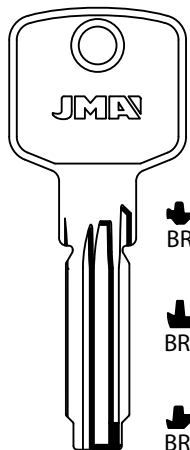

BRI-26

BRI-28

BRI-29

BRI-31

BRI-33

*CAPRI-DAKAR-
DAKAR EXPRESS*

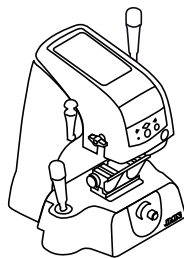

DAKKI

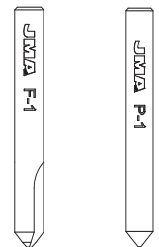
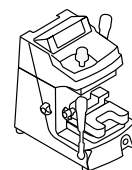

F1 P1

AD-CI

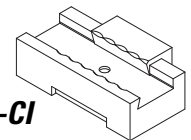

BULAT

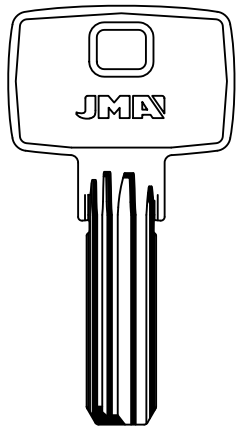

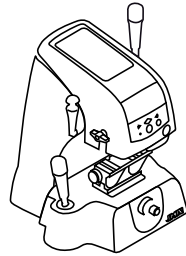

BUL-1

*CAPRI-DAKAR-
DAKAR EXPRESS*

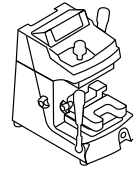

DAKKI



F1



P1

BURG

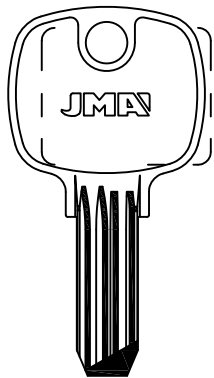

450

BUR-33

*CAPRI-DAKAR-
DAKAR EXPRESS*

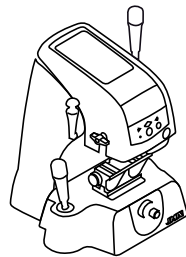

DAKKI

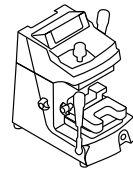

F1



P1

BYP

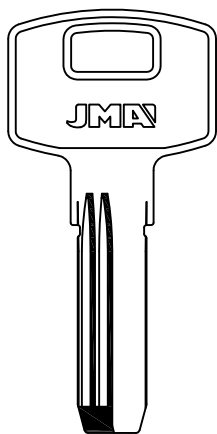

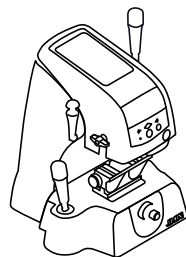

AP-5D

*CAPRI-DAKAR-
DAKAR EXPRESS*

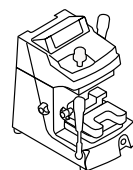

DAKKI



F19



P19

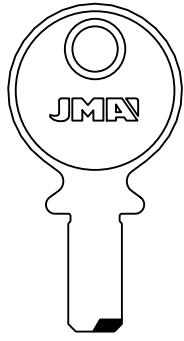

CE-114

**CAPRI-DAKAR-
DAKAR EXPRESS**

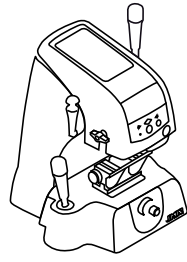

DAKKI

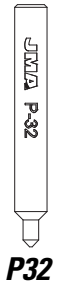
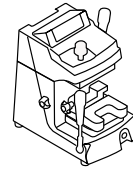

XCODE

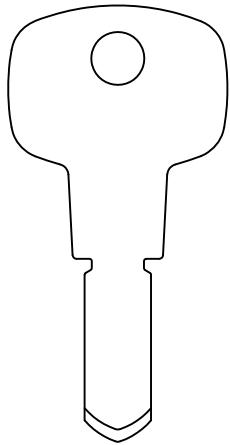
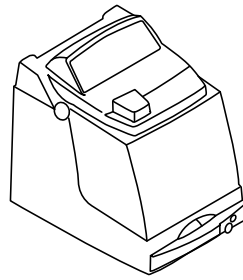

WSM

**CAPRI-DAKAR-
DAKAR EXPRESS**

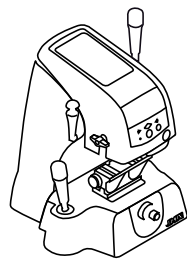

DAKKI

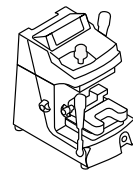

XCODE

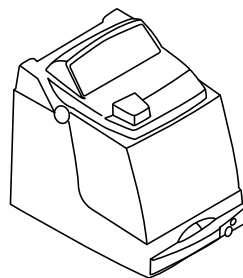

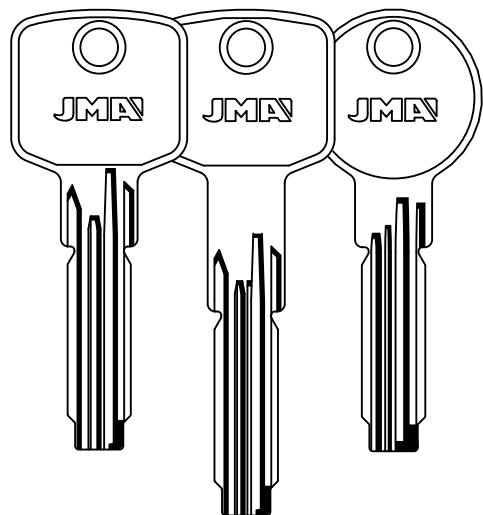

CAPRI-DAKAR-
DAKAR EXPRESS

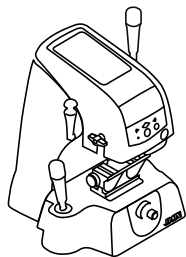

DAKKI

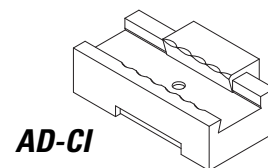
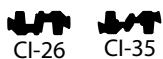
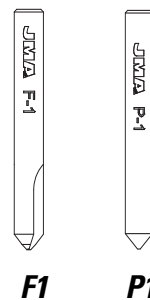
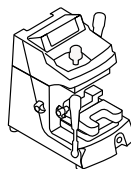

XCODE

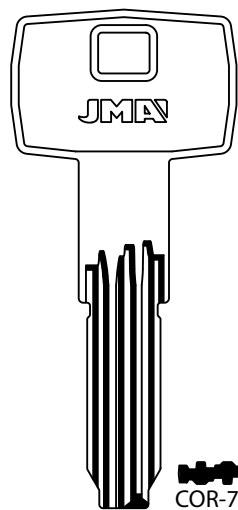
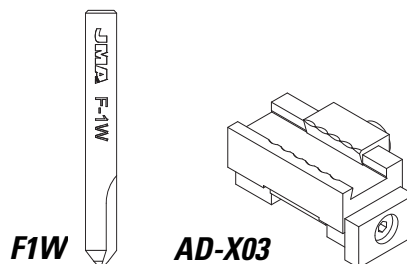
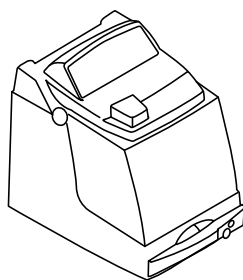

CAPRI-DAKAR-
DAKAR EXPRESS

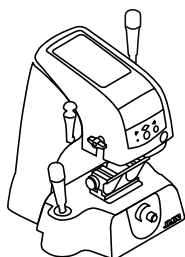

DAKKI

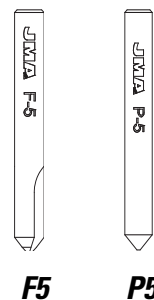
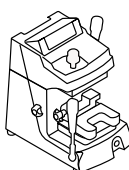

DAF

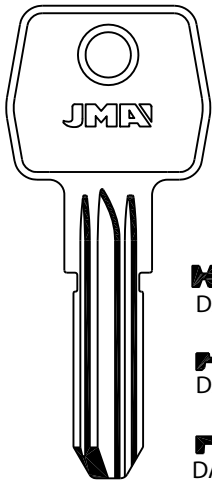

 DAF-2

 DAF-3D

 DAF-4D

CAPRI-DAKAR- DAKAR EXPRESS

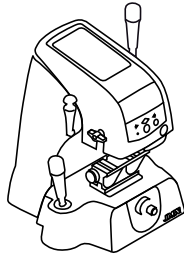

DAKKI

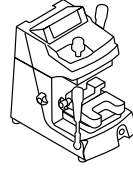

F13



P13

DEKABA

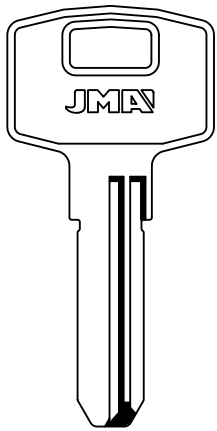

 DEK-3

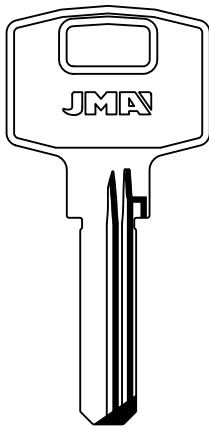

 DEK-4

 DEK-8

CAPRI-DAKAR- DAKAR EXPRESS

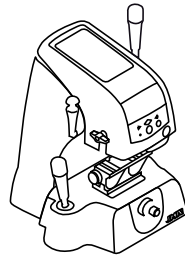

DAKKI

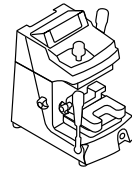

F1

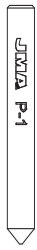

P1

DELCA

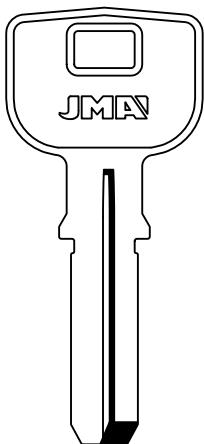

 DLC-3

CAPRI-DAKAR- DAKAR EXPRESS

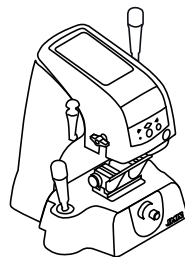

DAKKI

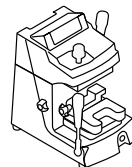

F1

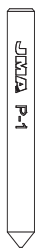

P1

DENNY

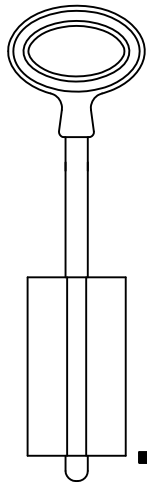

DEN-1

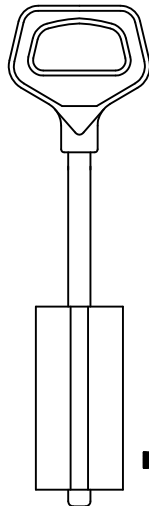

DEN-2

SENA

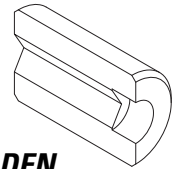
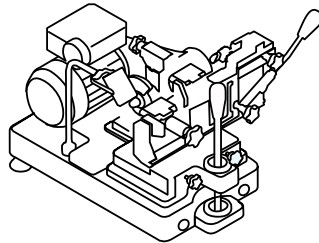

AD-DEN

DIERRE

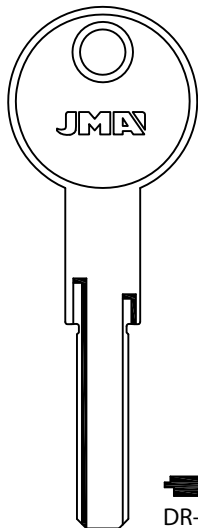

DR-1

CAPRI-DAKAR- DAKAR EXPRESS

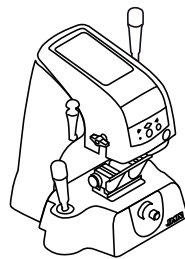

DAKKI

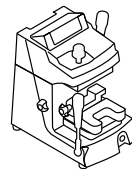

F11



P11

DOM

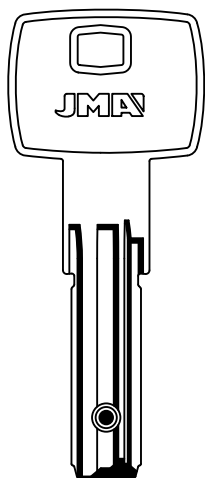

DOM-B1

CAPRI-DAKAR- DAKAR EXPRESS

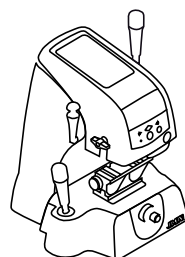

DAKKI

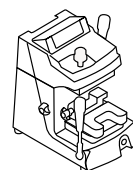

F1



P1

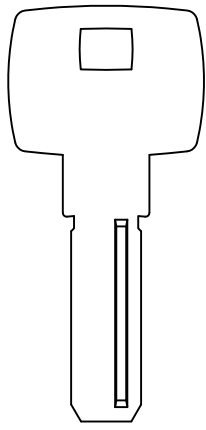

038
IX5 DAS

CAPRI-DAKAR-
DAKAR EXPRESS

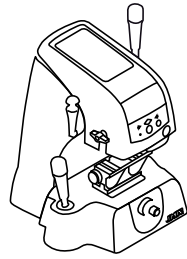

DAKKI

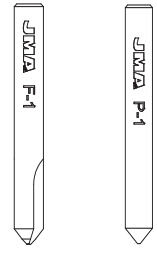
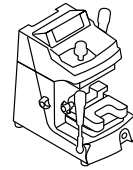

F1 P1

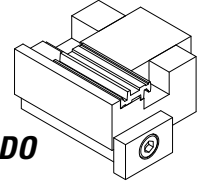

AD-DO

XCODE (Password Protected-DOM authorization)

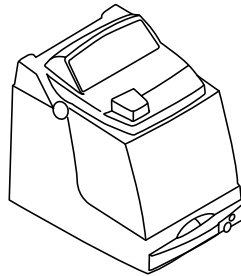

F1W

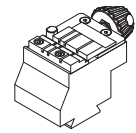

M4

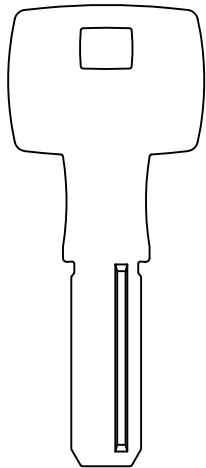

138
IX DAS

CAPRI-DAKAR-
DAKAR EXPRESS

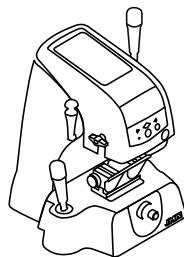

DAKKI

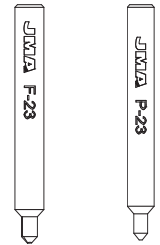
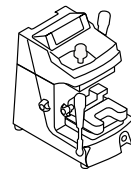

F23 P23

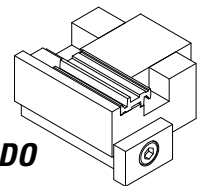

AD-DO

XCODE (Password Protected-DOM authorization)

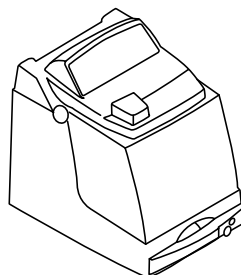

F23W

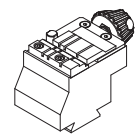

M4

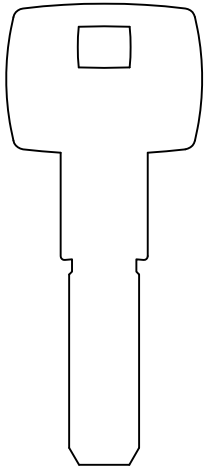

102/121
IX6 KG

*CAPRI-DAKAR-
DAKAR EXPRESS*

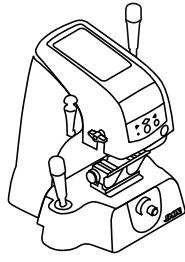

DAKKI

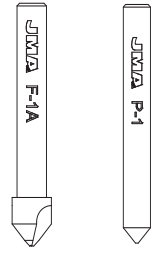
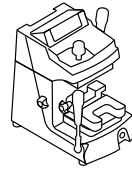

F1A P1

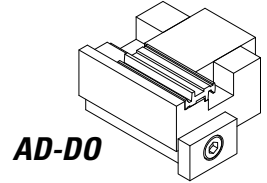

AD-DO

XCODE (Password Protected-DOM authorization)

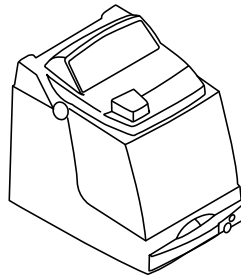

F1A

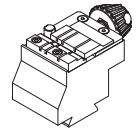

M4

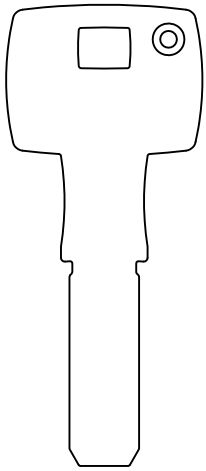

132 / 232
IX6 SR

*CAPRI-DAKAR-
DAKAR EXPRESS*

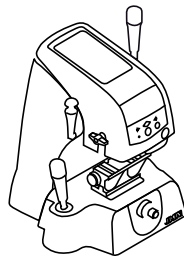

DAKKI

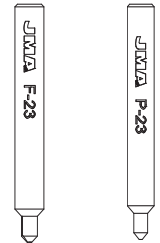
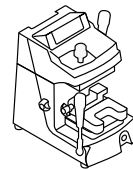

F23 P23

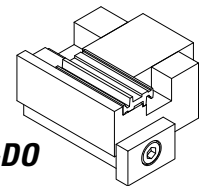

AD-DO

XCODE (Password Protected-DOM authorization)

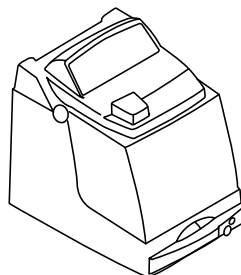

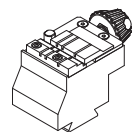

F23W

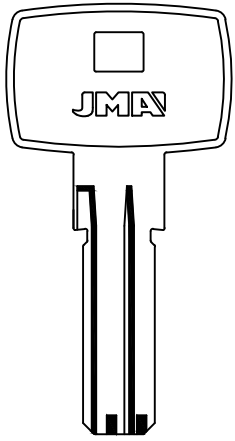

M4

DOM



 DOM-56D

 DOM-63D

CAPRI-DAKAR-
DAKAR EXPRESS

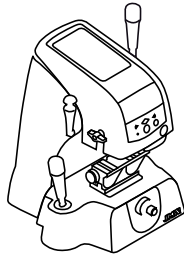

DAKKI

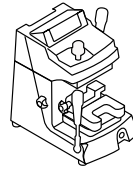

F1

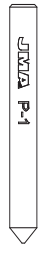

P1

XCODE (Password Protected-DOM authorization)

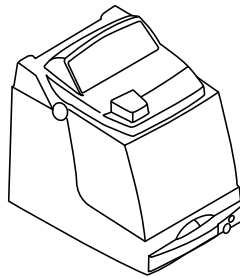

F1W



DOM-DORMA

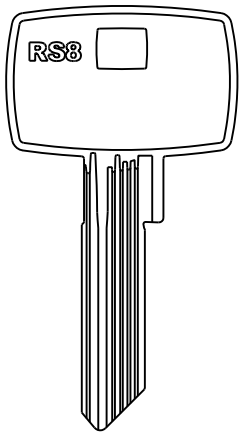

 RS8 ORIGINAL

VIENNA-DAKOTA EXTRA- TITAN MASTER-
ECCO/ECCO PLUS-ECCO AUTOMATIC

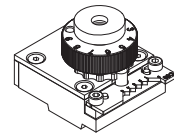
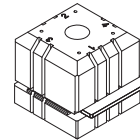
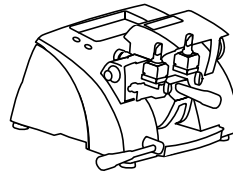

CODE CLAMP DO-716

SARATOGA

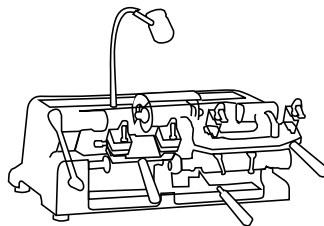

FP49

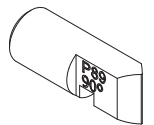

P89

PROCEDURE

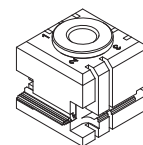
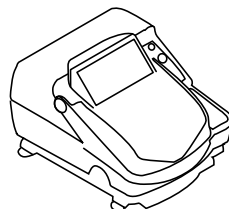

MP2

EUROLOCKS

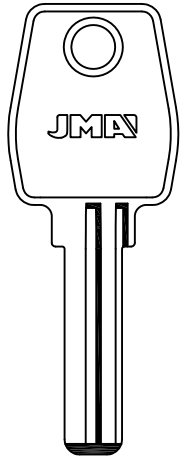

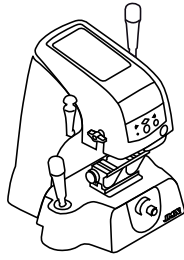

EU-12

*CAPRI-DAKAR-
DAKAR EXPRESS*

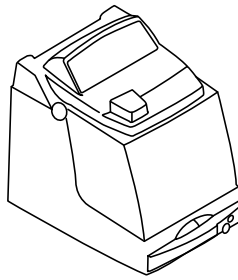

XCODE



DAKKI

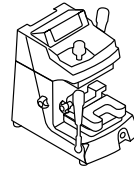

F3



P3

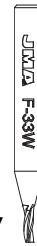

F33W

FAC

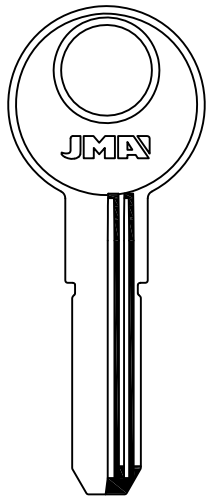

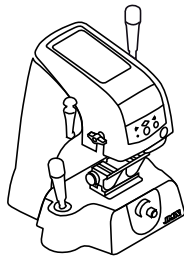

FAC-24

*CAPRI-DAKAR-
DAKAR EXPRESS*

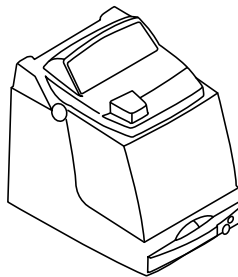

XCODE



DAKKI

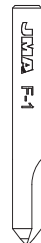
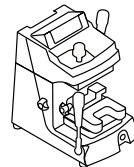

F1



P1



F1W

FAYN

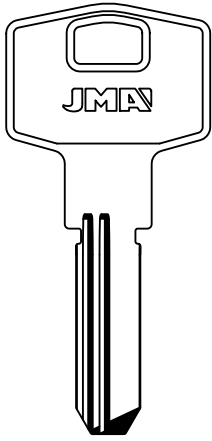

FAY-1D

CAPRI-DAKAR- DAKAR EXPRESS

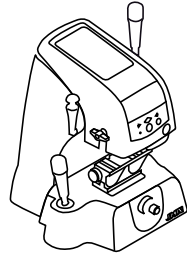

DAKKI

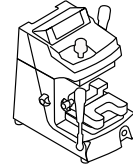

F5

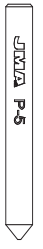

P5

FICHET

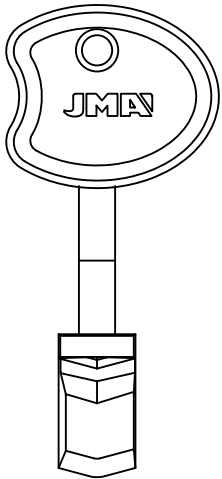

FIC-18

CAPRI-DAKAR- DAKAR EXPRESS

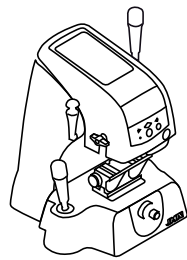

F18



P18

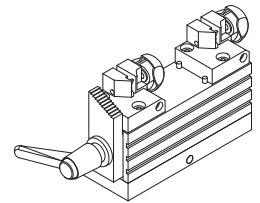

FI 18-DA

FTH

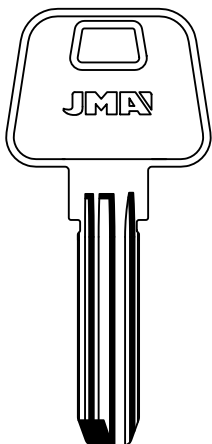

FTH-23

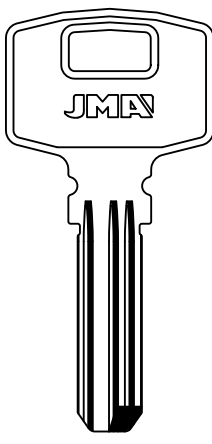

FTH-24

CAPRI-DAKAR- DAKAR EXPRESS

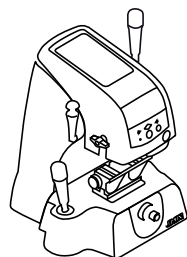

DAKKI

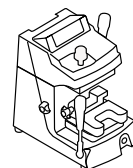

F5



P5

FTH

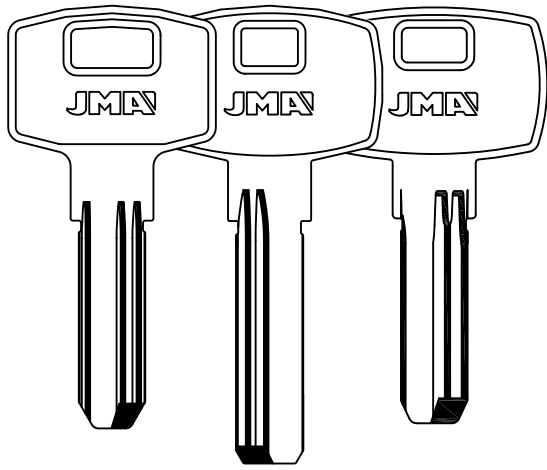

*CAPRI-DAKAR-
DAKAR EXPRESS*

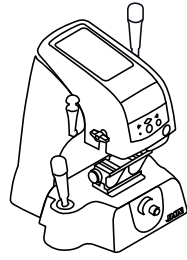

DAKKI

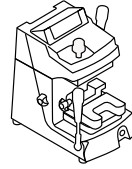

F5



P5



FTH-25



FTH-26D



FTH-29



FTH-30

GERDA

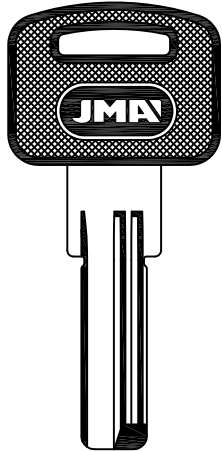

GDA-1P

*CAPRI-DAKAR-
DAKAR EXPRESS*

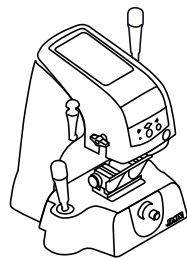

DAKKI

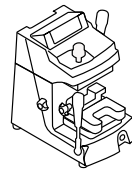

F1

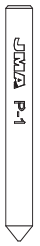

P1

HUF

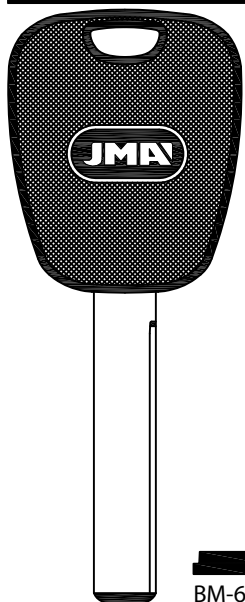

BM-6P

*CAPRI-DAKAR-
DAKAR EXPRESS*

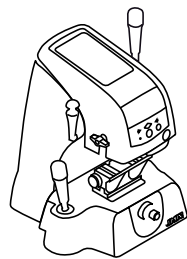

DAKKI

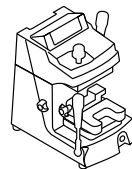

F11

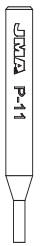

P11

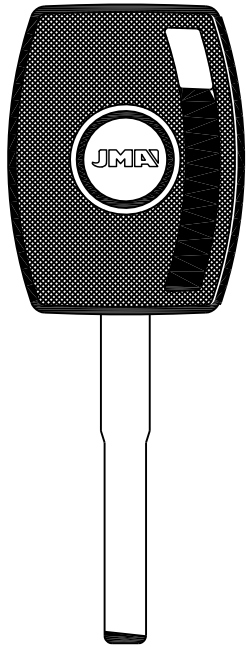

FO-24P

CAPRI-DAKAR- DAKAR EXPRESS

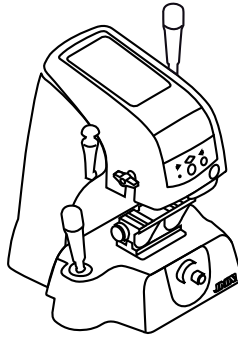

F11



P11

DAKKI

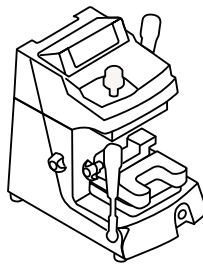

F11

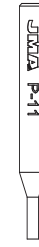

P11

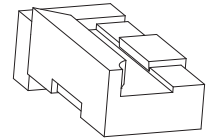

AD-F024

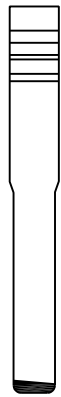

FO-24C1

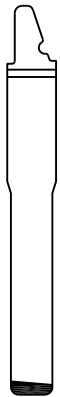

FO-24C2

XCODE

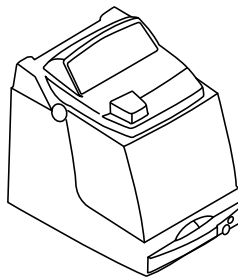

F11W

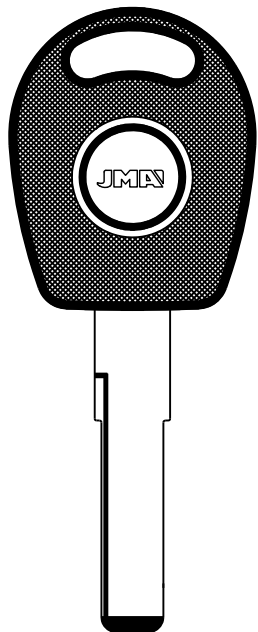

HU-HAAP1

*CAPRI-DAKAR-
DAKAR EXPRESS*

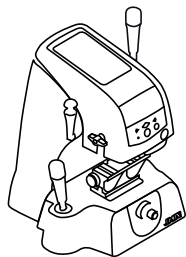

DAKKI

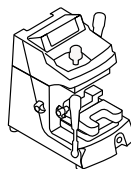

F11

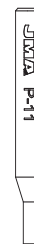

P11

XCODE

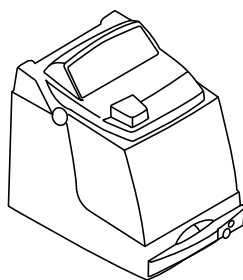

F-17W

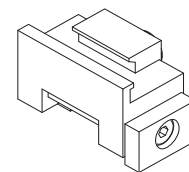

AD-AU

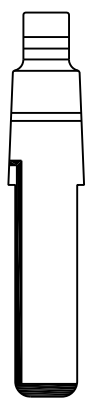

HU-HAAC1

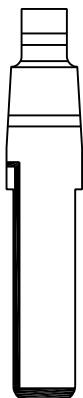

HU-HAAC2



HU-NAAC2

*CAPRI-DAKAR-
DAKAR EXPRESS*

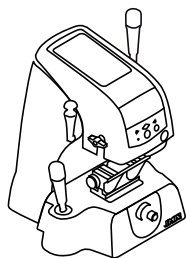

DAKKI

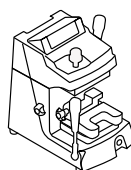

F11



P11

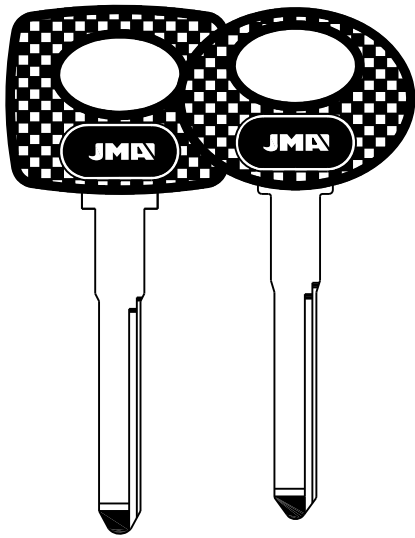

ME-4P

ME-5P

CAPRI-DAKAR- DAKAR EXPRESS

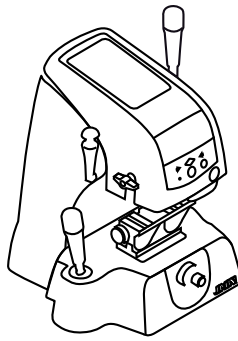

F11



P11

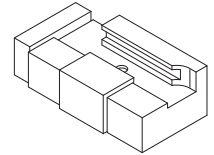

AD-MM

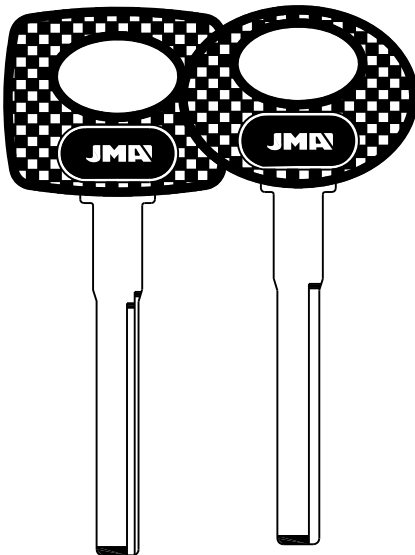

ME-10P

ME-12P

ME-11P

DAKKI

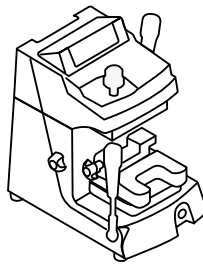

F11

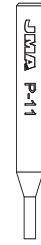

P11

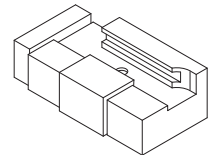

AD-MM

XCODE

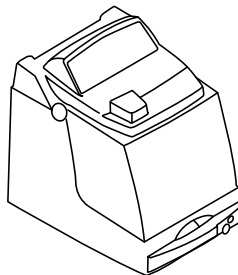

F11W

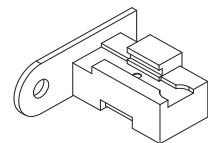

AD-X04

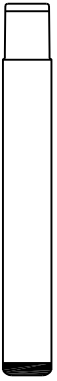

OP-11C1

CAPRI-DAKAR- DAKAR EXPRESS

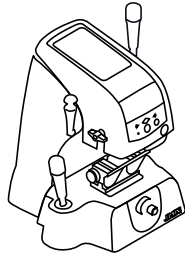

DAKKI

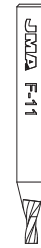
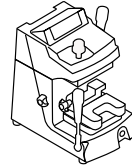

F11

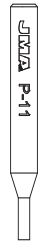

P11

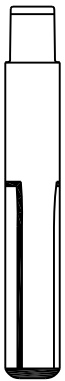

OP-WHC1

CAPRI-DAKAR- DAKAR EXPRESS

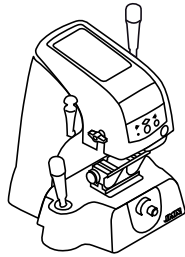

DAKKI

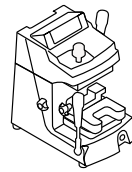

F11

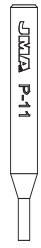

P11

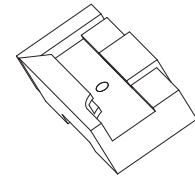

AD-OP

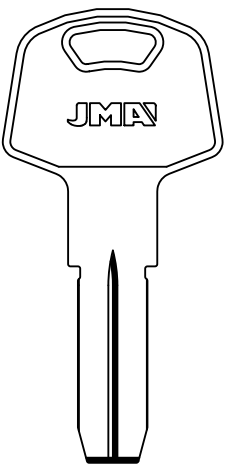

IF-4

CAPRI-DAKAR- DAKAR EXPRESS

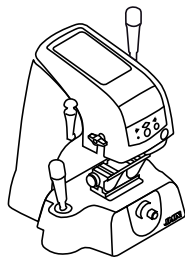

DAKKI

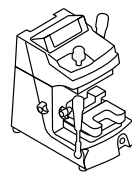

F1

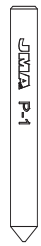

P1

IFAM

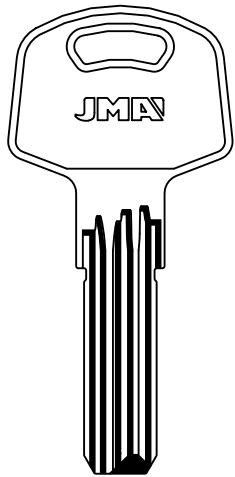

IF-6

CAPRI-DAKAR- DAKAR EXPRESS

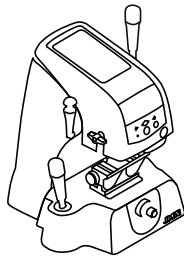

DAKKI

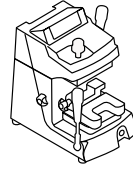

F19

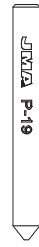

P19

ISEO

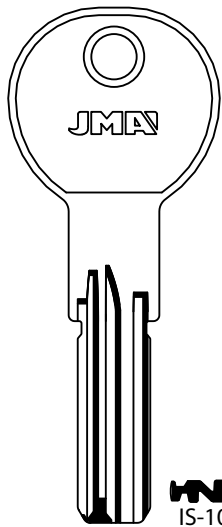

IS-10

CAPRI-DAKAR- DAKAR EXPRESS

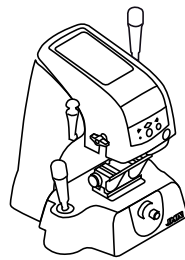

DAKKI

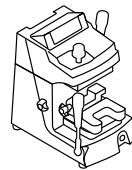

F1

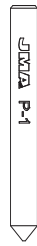

P1

KALE

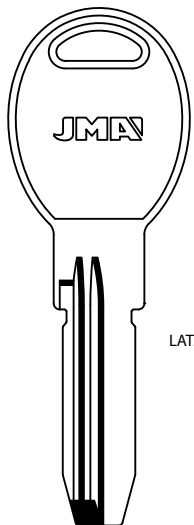

LAT.

CAPRI-DAKAR- DAKAR EXPRESS

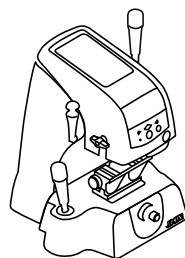

DAKKI

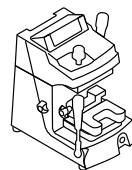

F1

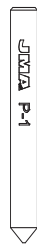

P1

KAE-11D

JMA®

Copyright by Alejandro Altuna S.A. 2012

ATENCIÓN: Concerniente a las marcas y denominaciones comerciales ver nota en índice.
ATTENTION: Concerning the marks and commercial denominations see note in index.
ATTENTION: Concernant les marques et dénominations commerciales voir la note dans l'index.
ACHTUNG: Beziehen auf die marke und handelsname sehen sie die notiz im index.

KESO

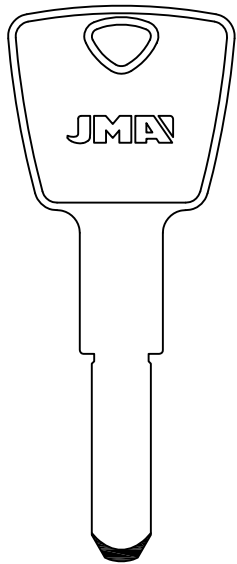

KE-5

CAPRI-DAKAR-
DAKAR EXPRESS

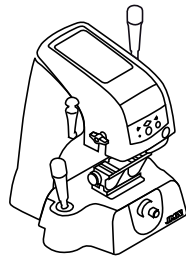

DAKKI

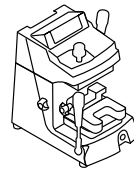

F1



P1

XCODE

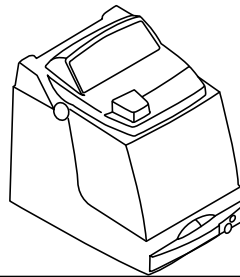

F1W

LINCE

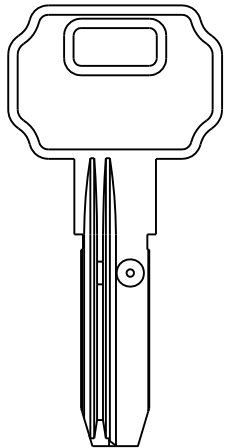

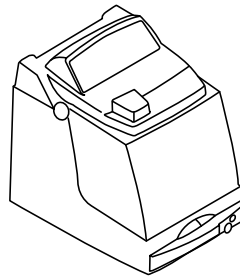

C2/C3/C4
ORIGINAL

XCODE

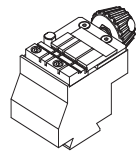

F5W



M7

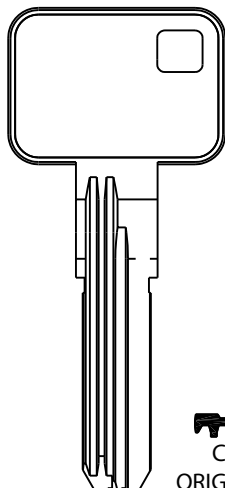

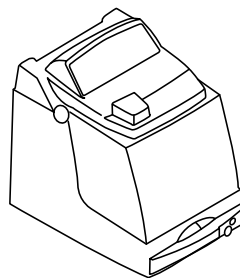

C5
ORIGINAL

XCODE

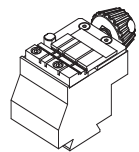

F28W



M7

MASTER LOCK

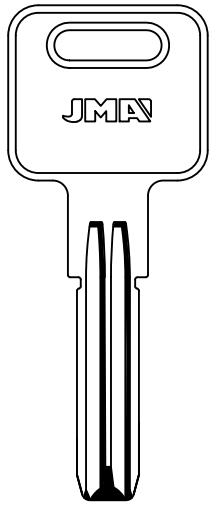

MASL-1

*CAPRI-DAKAR-
DAKAR EXPRESS*

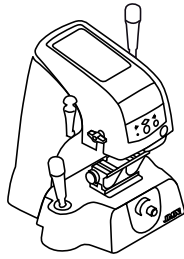

DAKKI

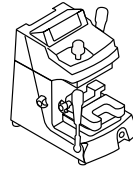

F1

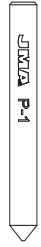

P1

MCM

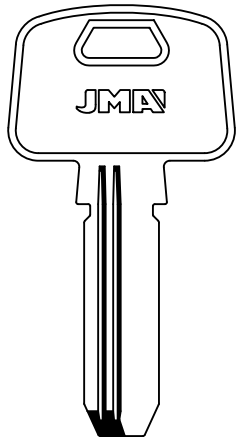

MCM-10

*CAPRI-DAKAR-
DAKAR EXPRESS*

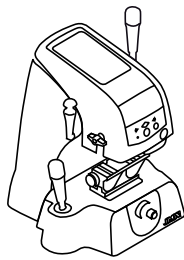

DAKKI



F13



P13

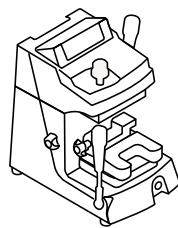

XCODE



F13



P13

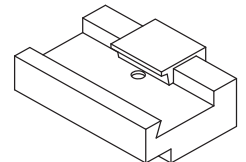

AD-MCM

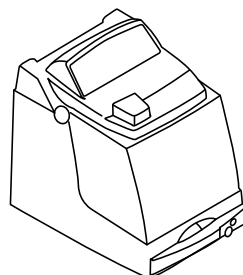

F13W

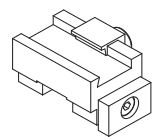

AD-X05

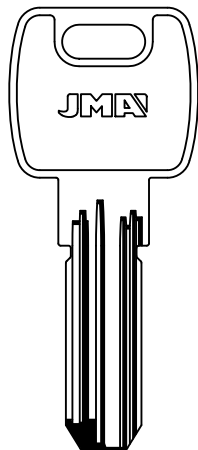

MCM-16
MCM-21D

*CAPRI-DAKAR-
DAKAR EXPRESS*

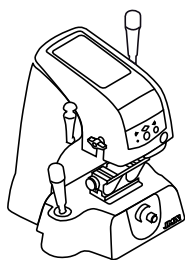

DAKKI

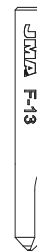
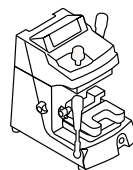

F13

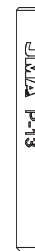

P13

XCODE

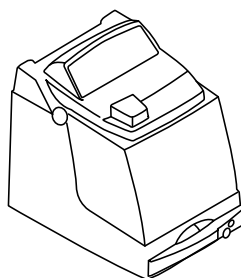

F13W

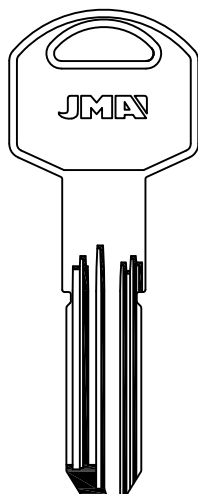

MCM-27

*CAPRI-DAKAR-
DAKAR EXPRESS*

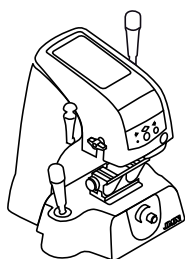

DAKKI

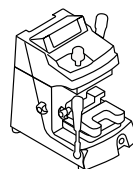

F13

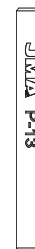

P13

XCODE

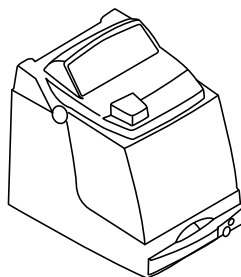

F13W

MSM

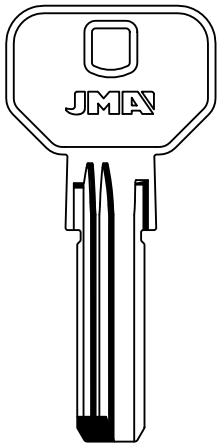

MSM-1

CAPRI-DAKAR- DAKAR EXPRESS

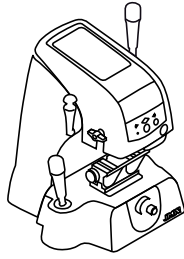

DAKKI

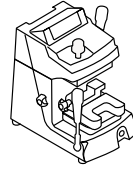

F19



P19

MUL.T.LOCK

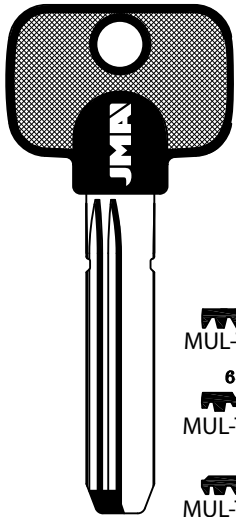

MUL-T3.P1

64
MUL-T8.P1

MUL-T9.P1

JUNIOR
MUL-T11.P1

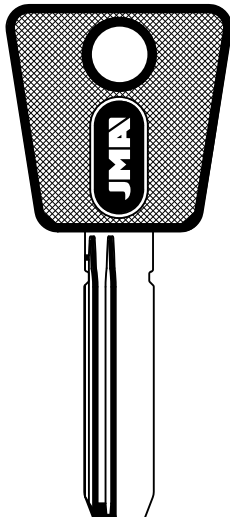

MUL-T10.P

CAPRI-DAKAR- DAKAR EXPRESS

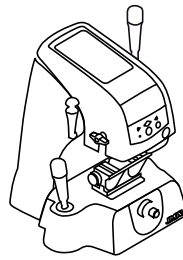

XCODE

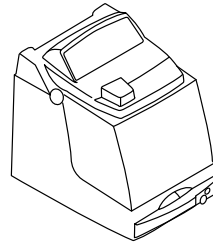

DAKKI

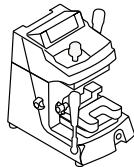

F12A P12A



F12B P12B



PFAFFENHAIN

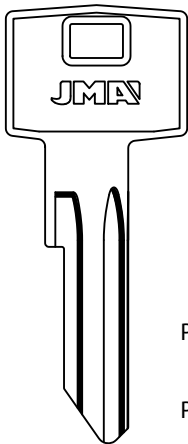

PFA-4

A21
PFA-10D

A22
PFA-11D

A23
PFA-12D

EA
PFA-13D

EB
PFA-14D

EH
PFA-15D

EN
PFA-16D

RF
PFA-17D

RG
PFA-18D

CAPRI-DAKAR- DAKAR EXPRESS

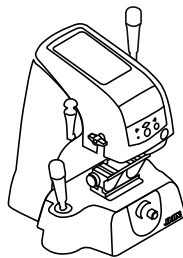

DAKKI

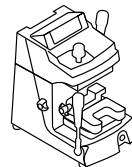

F34



P34

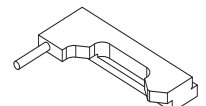

AD-PFA
(Puntos laterales, latera dimples)

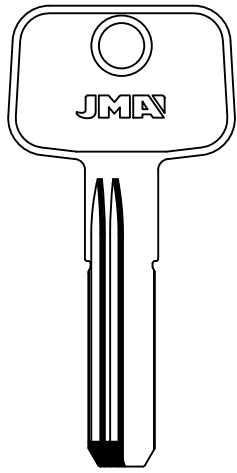

JMA
PTN-1D

CAPRI-DAKAR-
DAKAR EXPRESS

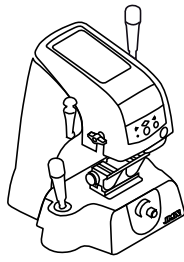

DAKKI

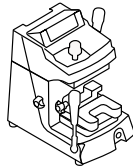

F5



P5



F19



P19

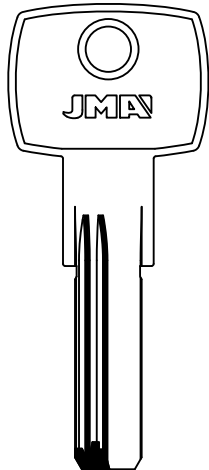

P04.....
1-2-3-4-5-6
JMA
PTN-2D

CAPRI-DAKAR-
DAKAR EXPRESS

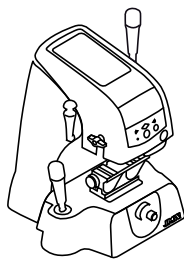

DAKKI

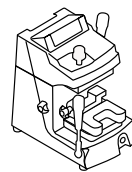

F19

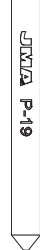

P19

XCODE

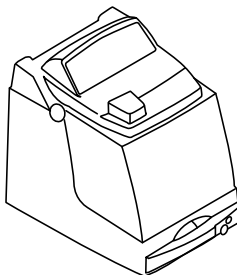

F19

ROSSETTI

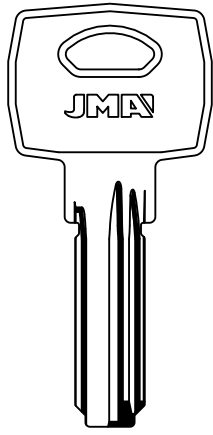

ROSE-1

*CAPRI-DAKAR-
DAKAR EXPRESS*

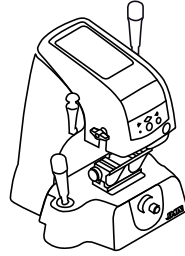

DAKKI

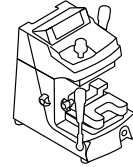

F1

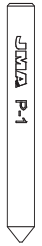

P1

SECUREMME

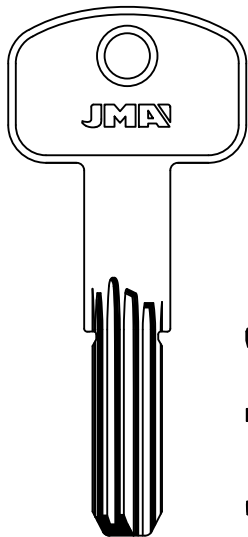

KP2
SEC-1
K1
SEC-2
SEC-3

*CAPRI-DAKAR-
DAKAR EXPRESS*

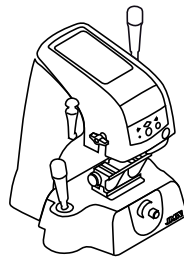

DAKKI

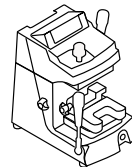

F19



P19

SERRALLER

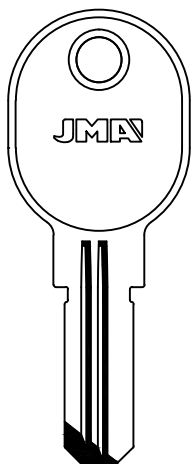

SER-3D

*CAPRI-DAKAR-
DAKAR EXPRESS*

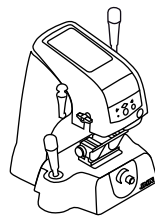

XCODE

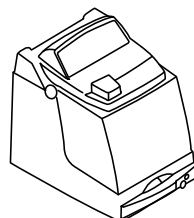

DAKKI

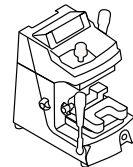

F1



P1



F1W

JMA[®]

Copyright by Alejandro Altuna S.A. 2012

ATENCIÓN: Concerniente a las marcas y denominaciones comerciales ver nota en índice.
ATTENTION: Concerning the marks and commercial denominations see note in index.
ATTENTION: Concernant les marques et dénominations commerciales voir la note dans l'index.
ACHTUNG: Beziehen auf die marke und handelsname sehen sie die notiz im index.

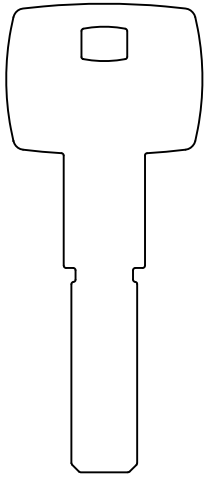

 ST15

XCODE

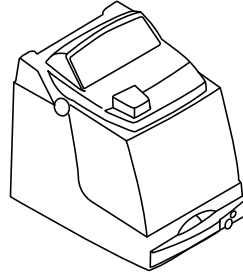

F23W

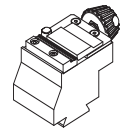

M5

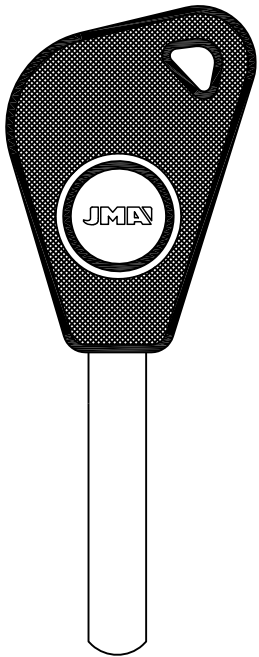

 SUB-2P

CAPRI-DAKAR- DAKAR EXPRESS

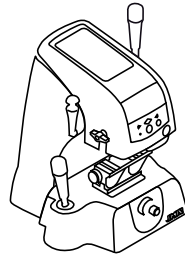

DAKKI

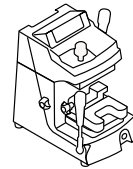

F11

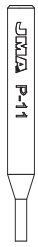

P11

XCODE

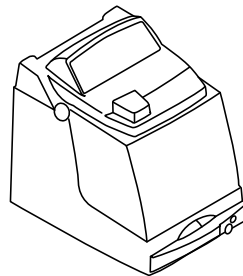

F11W

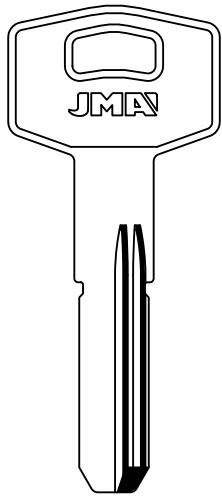

TRO-1 TRO-1D

CAPRI-DAKAR- DAKAR EXPRESS

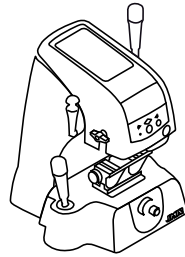

DAKKI

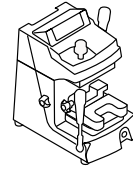

F1

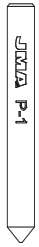

P1

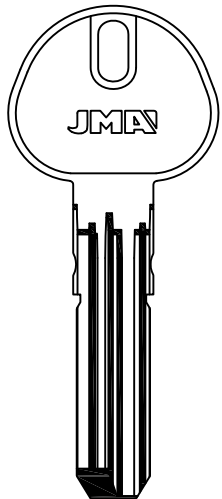

TC6
TC-1

CAPRI-DAKAR- DAKAR EXPRESS

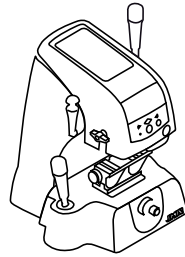

DAKKI

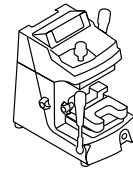

F13

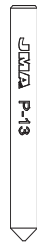

P13

XCODE

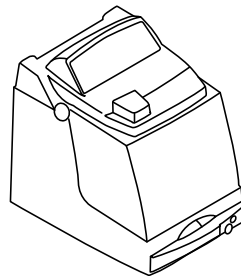

F13W

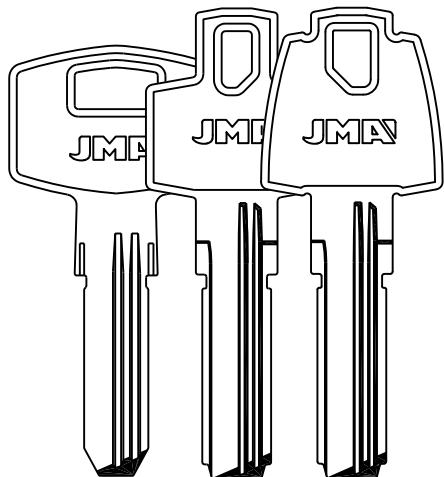

TE-T11

TE-T61

TE-T62

CAPRI-DAKAR-
DAKAR EXPRESS

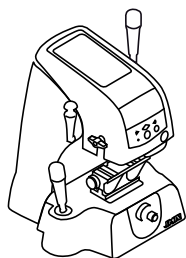

DAKKI

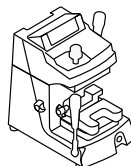

F5

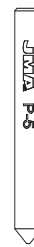

P5

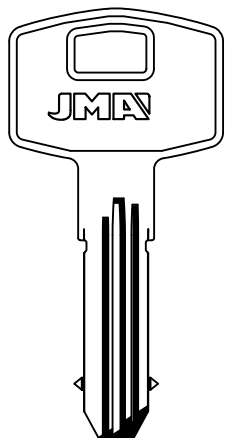

TE-T12PLUS

CAPRI-DAKAR-
DAKAR EXPRESS

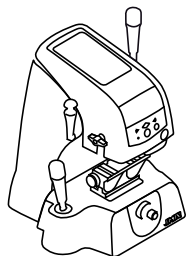

DAKKI

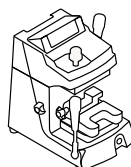

F5



P5

AD-T12P

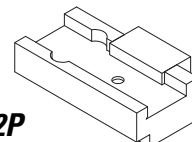

TOYO-30P1

CAPRI-DAKAR-
DAKAR EXPRESS

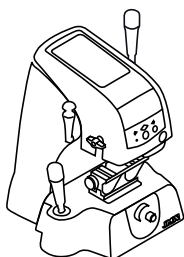

DAKKI

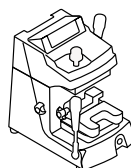

F11

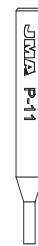

P11

TRW-SIPEA

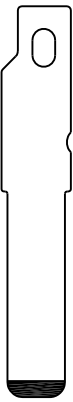

FI-16P
FI-16P1

FI-16C1

*CAPRI-DAKAR-
DAKAR EXPRESS*

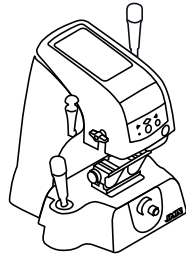

DAKKI

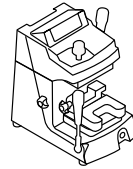

F33



P33

UNIVERSAL

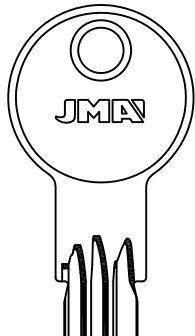

TX-2
ISEO

*CAPRI-DAKAR-
DAKAR EXPRESS*

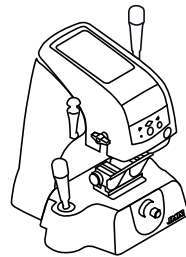

DAKKI

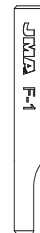
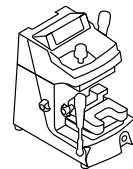

F1

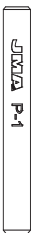

P1

URBIS

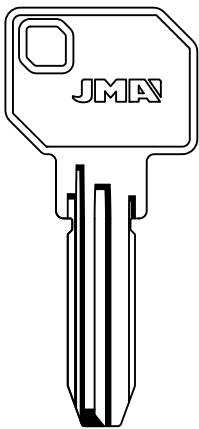

URB-3D
URB-4D

*CAPRI-DAKAR-
DAKAR EXPRESS*

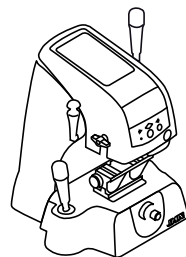

DAKKI

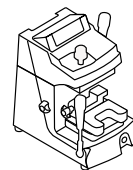

F1



P1

VACHETTE

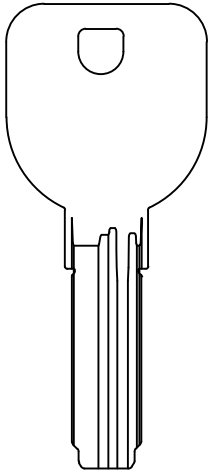

VRX
ORIGINAL

*CAPRI-DAKAR-
DAKAR EXPRESS*

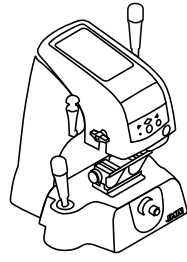

DAKKI

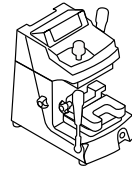

F1



P1

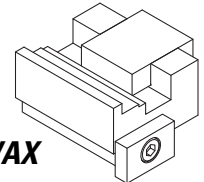

AD-VAX

VALEO

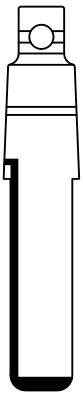

HU-HAAC3

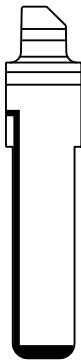

HU-HAAC4

*CAPRI-DAKAR-
DAKAR EXPRESS*

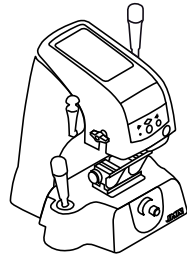

DAKKI

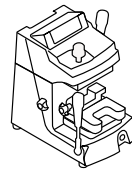

F11

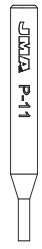

P11

XCODE

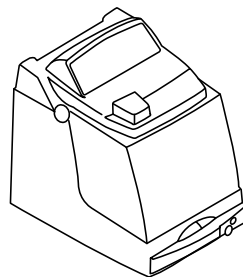

F17W

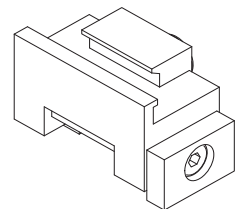

AD-AU



PEU-1C1

*CAPRI-DAKAR-
DAKAR EXPRESS*

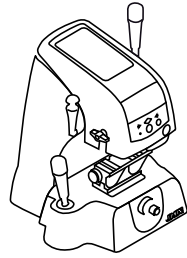

DAKKI

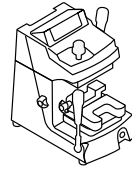

F11



P11

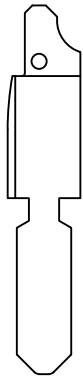

PEU-2C1

*CAPRI-DAKAR-
DAKAR EXPRESS*

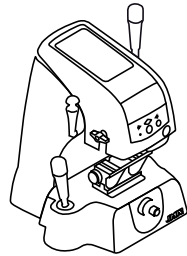

DAKKI

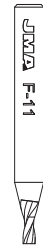
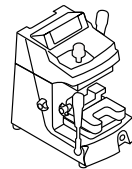

F11



P11

AD-MJ

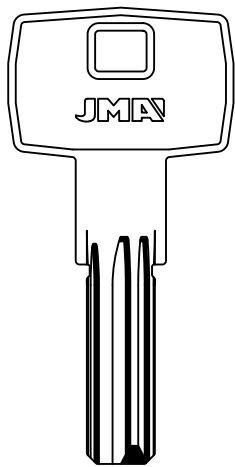
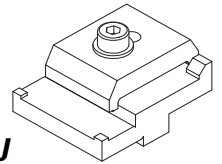

VI-14

*CAPRI-DAKAR-
DAKAR EXPRESS*

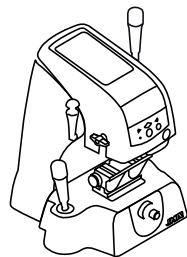

DAKKI

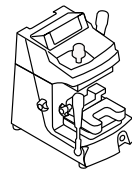

F1

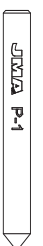

P1

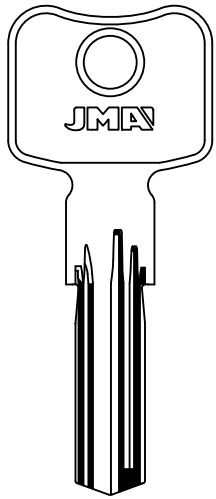

WILKA
WIL-22

CAPRI-DAKAR- DAKAR EXPRESS

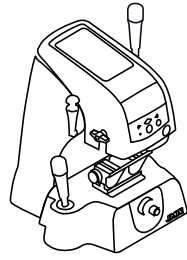

DAKKI

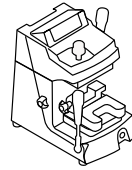

F1



P1

XCODE

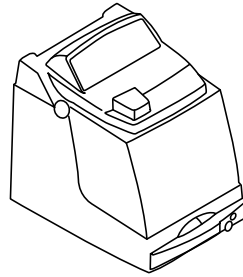

F1W

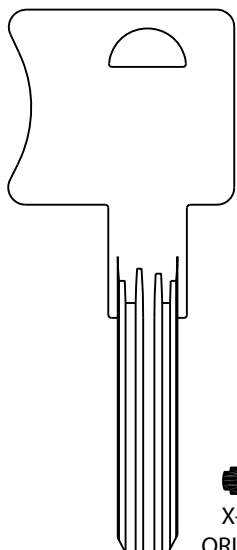

X-TRA
ORIGINAL

XCODE

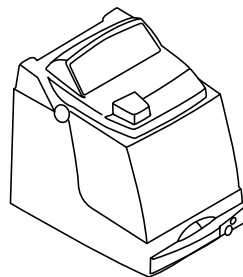

F13W

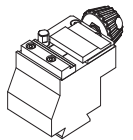

M8

AD-X09
(Puntos Laterales, lateral dimples)

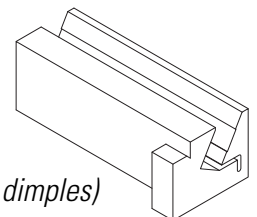

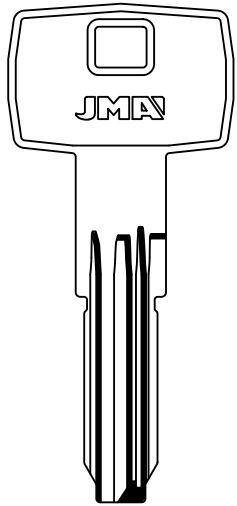

YA-81

CAPRI-DAKAR- DAKAR EXPRESS

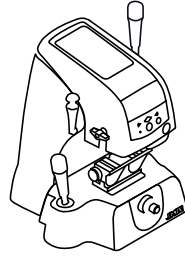

DAKKI

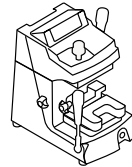

F1

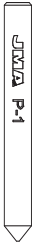

P1

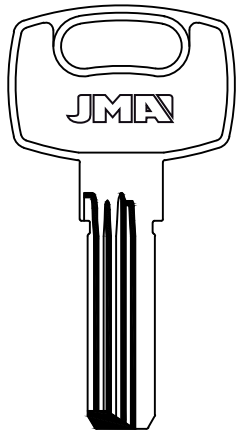

YAR-3

CAPRI-DAKAR- DAKAR EXPRESS

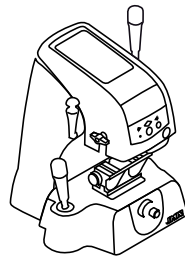

DAKKI

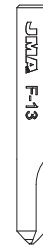
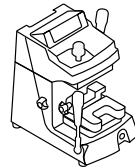

F13

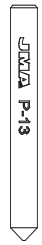

P13

XCODE

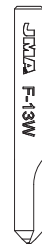
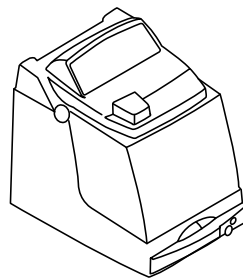

F13W

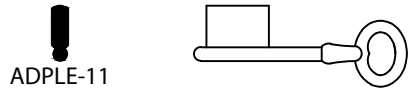

ADPLE-11

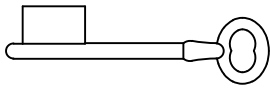

ADPLE-22

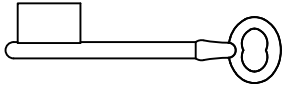

ADPLE-33

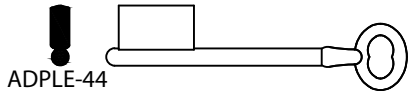

ADPLE-44

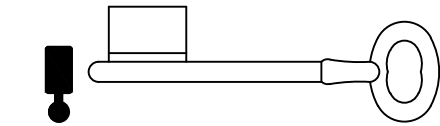

ADPLE-55

SENA

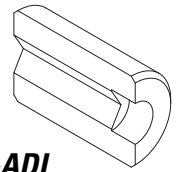
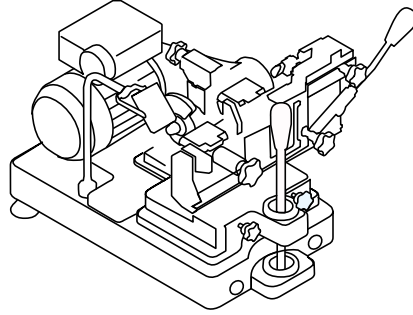

AD-ADL

JMA HEADQUARTERS
ALEJANDRO ALTUNA, S.A.

Tel +34 943 79 30 00
Fax +34 943 79 72 43
Bidekurtzeta, 6
P.O.Box - Apdo. 70
20500 Arrasate - Mondragón
Gipuzkoa - SPAIN

www.jma.es
ventas@jma.es

JMA ARGENTINA

JMA ARGENTINA S.A.
Tel +54 3461 462 422
Fax +54 3461 462 422
Av. Central Acero Argentino Oeste 678
Parque industrial COMIRSA
2900 San Nicolas (Prov. Buenos Aires)

www.jma-argentina.com
info@jma-argentina.com

JMA FRANCE

Tel +33 01 39 22 42 10
Fax +33 01 39 22 42 11
Technoparc
13, rue Edouard Jeanneret
F-78306 Poissy Cedex

www.jmafrance.fr
service.commercial@jmafrance.fr

JMA INDIA

JMA KEYS INDIA PVT. LTD
Tel +91 124 428 5450
Fax +91 124 428 5451
H-239 & H-240, Sushant Shopping Arcade
Sunshant Lok-1, Block B
122002 Gurgaon
Haryana

www.jmakeys.in
info@jmakeys.in

JMA MAROC

JMA MAROC S.A. R.L.
Tel +212 656 195 195
Fax +212 520 150 536
El Oulfa
Casablanca
Marruecos

www.jma.ma
jma@jma.ma

JMA MEXICO

LLAVES ALTUNA DE MEXICO S.A de C.V.
Tel +52 33 3777 1600
Fax +52 33 3777 1609
Av. Aviación No. 5520
Col. San Juan de Ocotlán
C.P. 45019 Zapopan, Jalisco

www.jma.com.mx
ventas@jma.com.mx

JMA POLSKA

JMA POLSKA Sp. z o.o.
Tel +48 42 835 12 80
Fax +48 42 835 12 85
91-342 Lodz ul. Zbąszynska 3

www.jmapolska.pl
biuro@jmapolska.pl

JMA PORTUGAL

ALTUNA PORTUGAL
COMERCIO DE CHAVES UNIPESSOAL, LDA.
Tel +351 219 947 470
Fax +351 219 947 471
Urbanização dos Areiros, Lote 67 C/v
2695-733 São Joao da Talha

www.jmaportugal.com
comercial@jmaportugal.com

JMA UK

SKS LTD
Tel +44 144 229 1400
Fax +44 144 286 3883
Unit 2, Canal Side
Northbridge Road
Berkhamstead
Herts HP4 1EG

www.skskeys.co.uk
sales@skskeys.co.uk

JMA URUGUAY

JMA URUGUAY S.A.
Tel +598 2908 1175
Fax +598 2900 6681
Mercedes 1420
11100 Montevideo
Uruguay

www.jma.com.uy
info@jma.com.uy

JMA USA

ALTUNA GROUP USA INC.
Tel +1 817 385 0515
Fax +1 817 385 4850
1513 Greenview Drive
75050 Grand Prairie, Texas

www.jmausa.com
info@jmausa.com

EL LIDER EN TECNOLOGÍA
THE LEADER IN TECHNOLOGY

EL LIDER EN CALIDAD
THE LEADER IN QUALITY

**EL LIDER EN COMPROMISO
MEDIOAMBIENTAL**
THE LEADER IN THE
COMMITMENT TO THE
ENVIRONMENT

EL LIDER EN SERVICIO
THE LEADER IN SERVICE

**ABRIENDO MILLONES DE PUERTAS
EN TODO EL MUNDO CADA DÍA**

*GLOBALLY UNLOCKING
MILLIONS OF DOORS DAILY*

A4-A5 **Aviso Legal**

Mezu Legala
Legal Warning
Informations Légales
Rechtliche Hinweise

A6-A7 **JMA es Compromiso**

JMA Konpromisoa da
JMA is Commitment
JMA, l'engagement
JMA bedeutet Verpflichtung

A8-A9 **JMA, el Lider**

JMA, Liderra
JMA, the Leader
JMA, le Leader
JMA der Markführer

A10-A11 **JMA, en el Mundo**

JMA, Munduan
JMA Worldwide
JMA dans le Monde
JMA in der Welt

A12-A13 **Descripción y Terminología**

Deskribapen eta Terminologia
Description and Terminology
Description et Terminologie
Begriffserklärung und Terminologie

A14-A15 **Símbolos y Nacionalidades**

Ikur eta Nazionalitateak
Symbols and Nationalities
Symboles et Nationalités
Symbole und Nationalitäten

A16-26 **LLAVES**

GILTZAK
KEYS
CLÉS
SCHLÜSSEL

A17- A20 **Indice General**

Aurkibidea
General Index
Index Generale
Gesamtverzeichnis

A21-A22 **Indice de Marcas**

Marken Aurkibidea
Brand Index
Index Marque
Hauptmarke

1 - 26 **Imágenes de Llaves**

Giltzen Irudiak
Keys Images
Images Clés
Schlüssel Bilder

27 - 70 **CAT. ESPECIALISTA DE MÁQUINAS DUPLICADORAS**

KOPIATZEKO MAKINEN GIDA ESPEZIALISTA
KEY CUTTING SPECIALIST'S GUIDE
SPÉCIALISTE CATALOGUE DE MACHINES DUPLICATRICES
SPEZIALISTKATALOG

29 - 33 **Fresas**

Fresak
Miling Cutters
Fraises
Fräse

35 - 70 **Imágenes de Llaves**

Giltzen Irudiak
Keys Images
Images Clés
Schlüssel Bilder

ESPAÑOL

SUPLEMENTO 2011.C10

Las llaves que aparecen en este catálogo son piezas JMA fabricadas por Alejandro ALTUNA S.A. o un subcontratista de éste. Están diseñadas para cilindros y cerraduras de los fabricantes cuyas marcas se indican en este catálogo.

Conforme a las disposiciones legales vigentes relativas a la propiedad industrial, las marcas o nombres comerciales indicados en este catálogo son propiedad exclusiva de los fabricantes de cilindros y cerraduras, así como de los fabricantes de automóviles, otros constructores, distribuidores y usuarios.

Dichas marcas o nombres comerciales se indican en calidad simplemente informativa con el fin de reco-

nocer con rapidez la cerradura a la que corresponden nuestras piezas.

Este catálogo está reservado exclusivamente a profesionales de la reproducción de llaves que utilizan piezas JMA.

Los datos referentes a los productos de este catálogo tienen carácter indicativo. Manteniendo siempre las características básicas, nos reservamos el derecho de realizar, sin previo aviso, modificaciones técnicas, estéticas o de otro tipo, por razones de evolución de los productos en cuestión.

Algunos modelos que están en este nuevo catálogo podrán recibirlos tanto con la marca y la referencia JMA como con otra marca del grupo ALTUNA.

EUSKERA

SUPL. 2011.C10

Katalogo honetan ageri diren giltzak Alejandro ALTUNA SA enpresak edo honek kontratatutako beste enpresa batek egindako JMA piezak dira. Katalogoan zehazten diren marken fabrikatzaileen zilindro eta sarrailetarako diseinatuta daude.

Jabetza industrialari buruz indarrean dauden legezadapenekin bat etorri, katalogo honetan zehaztutako merkataritza-markak edo izenak zilindro eta sarrailen fabrikatzaileen nahiz ibilgailuen fabrikatzaileen eta beste eraikitzaile, banatzaile eta erabiltzaile batzuen jabetza eskusibokoak dira.

Merkataritza-marka edo izen horiek zehaztasun gehiago emateko adierazten dira, gure piezak zein sarrailari dagozkion berehala ikusi ahal izateko.

Katalogo hau giltzen kopiak egiteko JMA piezak erabiltzen dituzten profesionalentzako da soilik. Katalogo honetako produktuei buruzko datuek izaera adierazgarria dute. Oinarritzko ezaugarriak gordez, produktuen bilakaeraren ondoriozko aldaketa teknikoak, estetikoak edo bestelakoak egiteko eskubidea dugu, aurretik horren berri eman beharrik gabe.

Katalogo berri honetan dauden eredueta batzuk JMA marka eta erreferentziarekin nahiz ALTUNA taldeko beste marka batekin jaso ahal izango dira.

ENGLISH

SUPL. 2011.C10

The keys that appear in this catalogue are JMA parts manufactured by Alejandro ALTUNA S.A. or one of its subcontractors. They are designed for cylinders and locks made by the manufacturers whose trademarks are indicated in this catalogue.

In accordance with legal requirements relating to industrial property rights, the trademarks or trade names indicated in this catalogue are the exclusive property of the manufacturers of the cylinders and locks, as well as automobile manufacturers, other constructors, distributors and users.

The aforementioned trademarks or trade names are indicated simply for information purposes so that the lock to which our parts correspond can be recognised quickly and easily.

This catalogue is for the exclusive use of professional key copiers who use JMA parts.

Data referring to the products in this catalogue are indicative in nature. Although the basic characteristics are maintained at all times, we reserve the right to make, without previous notice, any technical, aesthetic or other types of changes involved in the development of the products in question.

Some of the keys in this new catalogue could be received either with the JMA reference and trademark or with another trademark from the ALTUNA group.

FRANÇAIS

SUPL. 2011.C10

Les ébauches de clés reportées sur ce catalogue sont des ébauches JMA fabriquées par Alejandro ALTUNA S.A. ou un de ses sous-traitants Elles sont destinées aux cylindres et serrures des fabricants dont les marques sont indiquées dans ce catalogue.

Conformément aux dispositions légales en vigueur relatives à la propriété industrielle, les marques ou les dénominations commerciales citées dans ce catalogue sont la propriété exclusive des fabricants de cylindres et de serrures ainsi que des constructeurs de voitures, autres constructeurs, distributeurs et utilisateurs.

Ces marques ou dénominations commerciales sont indiquées à titre de simple information afin de connaître rapidement à quelle serrure nos ébauches sont destinées.

Ce catalogue est exclusivement réservé aux professionnels de la reproduction de clés, utilisant des ébauches JMA. Les renseignements sur les produits de ce catalogue sont donnés à titre indicatif. Tout en gardant les caractéristiques de base, nous nous réservons le droit d'apporter, sans préavis, des modifications techniques, esthétiques ou autres, dues à l'évolution des produits en question.

Des ébauches de, cet catalogue pourront être livrées soit avec la marque et référence JMA soit avec une autre marque du groupe ALTUNA.

DEUTSCH

SUPL. 2011.C10

Die in dem vorliegenden Katalog aufgeführten Schlüssel sind JMA-Teile, die von der Firma Alejandro ALTUNA, S.A., einem Zulieferanten von JMA, hergestellt werden. Sie sind für Zylinder und Schlösser derjenigen Hersteller entwickelt worden, deren Marken in diesem Katalog aufgeführt sind.

In Übereinstimmung mit den geltenden gesetzlichen Vorschriften bezüglich des gewerblichen Eigentums sind die im vorliegenden Katalog aufgeführten Marken und Firmennamen ausschließliches Eigentum der Zylinder- und Schloßhersteller, sowie der Automobilhersteller und anderer Konstrukteure, Vertreiber und Benutzer.

Diese Marken und Firmennamen werden nur zu Informationszwecken aufgeführt, mit dem Ziel, auf schnelle Weise zu erkennen, zu welchem Schloß unsere Teile gehören.

Dieser Katalog ist ausschließlich für Fachleute des Bereichs der Schlüsselreproduktion gedacht, die JMA-Teile verwenden.

Die Daten bezüglich der Produkte des vorliegenden Katalogs haben informativen Charakter. Bei Aufrechterhaltung der grundlegenden Eigenschaften behalten wir uns das Recht

vor, aus Gründen der Entwicklung der entsprechenden Produkte und ohne Vorankündigung technische, ästhetische oder andere Änderungen vorzunehmen.

Einige Modelle des neuen Katalogs können Sie sowohl mit der Marke und der Bezeichnung JMA erhalten, als auch mit jeder anderen Marke der Gruppe ALTUNA.

THE KEY TO EXCELLENCE
GLOBALLY UNLOCKING MILLIONS OF DOORS DAILY



ESPAÑOL

NUESTRO ÉXITO ESTÁ BASADO EN EL COMPROMISO DE LAS PERSONAS

Alejandro Altuna S.A. es la sociedad matriz e impulsora de Altuna Group. Fabrica todo tipo de **llaves para cerradura** así como **máquinas duplicadoras**. Sus productos van destinados al mercado **OEM** y a la reposición, en este caso con la marca **JMA**.

Fundada por el Sr. Alejandro Altuna en 1942 arrancó su actividad en Mondragón. En poco tiempo, una nueva generación familiar que apostó por el desarrollo y la inversión impulsó a la empresa a un importante crecimiento que consolidó a la marca **JMA** hacia los 60 como líder indiscutible del país.

Posteriormente, la estrategia de apertura de mercados exteriores apoyada en la internacionalización y siempre basada en un enfoque innovador de los procesos industriales, ha convertido a **ALTUNA GROUP** en el **primer productor de llaves europeo y referente mundial** en este campo.

Actualmente, 13 compañías en 4 continentes trabajan conjuntamente para el desarrollo y potenciación de la fuerza de nuestra marca JMA, conocida en más de 100 países en todo el mundo.

JMA integra equipos de **personas comprometidas** y motivadas por un proyecto común que nos ha permitido ser el mayor fabricante de llaves de Europa.

EUSKERA

GURE ARRAKASTA PERTSONEN KONPROMISOAN DATZA

Alejandro Altuna S.A. Altuna Groupen sozietate matrizea eta sustatzailea da. **Sarrailarako era guztietako giltzak** eta **kopiak egiteko makinak** ekoizten ditu. Bere produktuek **OEM** merkaturak eta birjarpena dute helburu, eta, kasu horretan, **JMA** markaz merkaturatzen dira.

Enpresa Alejandro Altuna jaunak sortu zuen 1942an, eta Arrasaten hasi zen lanean. Handik gutxira, familiako belaunaldi berriak garapenaren zein inbertsioaren alde egin zuen, eta enpresa bera ikaragarri hazi zen. Hori dela eta, 60ko hamarkadan, **JMA** marka herrialdeko lider eztabaia da.

Ondoren, kanpoko merkaturak irekitzeko estrategia nazioarteko bihurtzeko prozesuan oinarritu da, eta, beti-beti, industria-prozesuen ikuspegi berritzailea hartu du kontuan. Horren ondorioz, **ALTUNA GROUP** **lehen giltzagilea da Europan**, baita arlo horretako **munduko erreferentea** ere.

Gaur egun, 13 konpainiak 4 kontinentetan lan egiten dute elkarrekin, mundu zabaleko 100etik gora herrialdetan ezaguna den **JMA** markaren indarra garatzeko eta sustatzeko.

JMAko taldeetan **persona konprometituak** eta motibatuak daude, eta proiektu bateratua dute. Horri esker, Europako enpresa giltzagile handiena da.

ENGLISH

OUR SUCCESS IS BASED ON OUR PEOPLE'S COMMITMENT

Alejandro Altuna S.A. is the parent company and driving force behind the Altuna Group. It manufactures all types of **lock-keys and key-cutting machines**. Its products are for the **OEM** and replacement markets, in the latter case with the **JMA** brand.

Set up by Alejandro Altuna in 1942, it started the production in Mondragón (Spain). In a short time, a new generation of the family committed to development and investment saw the company through significant growth which consolidated the **JMA** brand in the 60's as the indisputable leader in Spain.

Later, the strategy of opening up to foreign markets backed by globalisation and always based on an innovative attitude towards industrial processes, turned the **ALTUNA GROUP** into the **largest producer of keys in Europe and a benchmark worldwide** in the field.

Currently 13 companies in four continents work together to develop the strength of our **JMA** brand, well known in more than 100 countries all over the world.

This successful trail has led us to become the biggest key producer in Europe based on **our people's commitment**.

JMA ES COMPROMISO

JMA IS COMMITMENT



FRANÇAIS

NOTRE SUCCÈS EST FONDÉ SUR L'ENGAGEMENT DES PERSONNES

*Alejandro Altuna S.A. est la société-mère qui a donné lieu au Groupe Altuna. Elle fabrique toutes sortes de **clés de serrure et de machines à copier**. Ses produits sont destinés au marché **OEM** et au remplacement, dans ce cas sous la marque **JMA**.*

*Alejandro Altuna en 1942, elle s'est établie à Mondragón. Très vite, une nouvelle génération familiale a misé sur le développement et grâce aux investissements engagés, l'entreprise a connu une forte croissance qui, dans les années 60, a imposé la marque **JMA** à la tête du secteur.*

*Par la suite, la stratégie d'ouverture sur les marchés extérieurs et une volonté d'internationalisation toujours sous-tendue par le recours aux procédés industriels les plus novateurs, a fait du **GROUPE ALTUNA** le **premier producteur de clés européen** et un **réfèrent mondial** dans ce domaine.*

Actuellement, 13 firmes sur 4 continents unissent leurs forces pour dynamiser et faire progresser notre marque JMA, connue dans plus de 100 pays du monde entier.

*Les équipes JMA sont formées de **personnes motivées et pleinement investies** dans un projet commun qui nous a permis de devenir le plus important fabricant de clés d'Europe.*

DEUTSCH

UNSER ERFOLG BASIERT AUF DAS ENGAGEMENT VON MENSCHEN

*Alejandro Altuna S.A. ist die Muttergesellschaft, aus der später die Altuna Group hervorging. Sie stellt **Schlüssel** aller Art sowie **Schlüsselkopiermaschinen** her. Ihre Produkte wenden sich an dem OEM- und den Ersatzschlüsselmarkt, in diesem Fall mit der Markenbezeichnung **JMA**.*

*Das Unternehmen wurde 1942 von Alejandro Altuna gegründet und begann seinen Werdegang in Mondragón. Innerhalb eines nur kurzen Zeitraums sorgte eine neue, auf Entwicklung und Investition setzende Familiengeneration für ein bedeutendes Wachstum und sicherte der Marke **JMA** damit Anfang der 60er Jahre die unbestreitbare Führungsposition im Land.*

*Später dann hat die auf das Konzept der Internationalisierung und der Innovation der industriellen Prozesse gestützte Strategie der Öffnung gegenüber ausländischen Märkten die **ALTUNA GROUP** zum **führenden europäischen Hersteller von Schlüsseln und einem weltweiten Bezugspunkt** für diesen Sektor werden lassen.*

Derzeit arbeiten 13 Unternehmen in 4 Kontinenten gemeinsam, um die Stärke der in über 100 Ländern der ganzen Welt bekannten Marke JMA zu potenzieren und weiterzuentwickeln.

*JMA arbeitet mit Teams **engagierter und motivierter Menschen**, die sich für ein gemeinsames Projekt einsetzen, das es uns möglich gemacht hat, der größte Hersteller von Schlüsseln in Europa zu werden.*

ESPAÑOL:

LIDER EN TECNOLOGÍA:

Una apuesta sólida por la calidad y la innovación basada en la automatización y garantía de procesos y soportada por una vocación inversora a largo plazo.

LIDER EN CALIDAD:

En el ámbito de la Calidad Alejandro Altuna S.A. siempre ha sido una empresa líder y pionera en su sector. Nuestra política de calidad se basa en la prevención y planificación, mejora continua, satisfacción del cliente y participación de las personas

Estos valores están impregnados en nuestra empresa desde sus orígenes y han sido, junto con una adecuada política de inversión en instalaciones y maquinaria, el motivo principal de nuestro éxito, que además nos permite asegurar la competitividad de la empresa y con ello el futuro a largo plazo.

Además de la Certificación en Calidad de acuerdo a la ISO 9001, Alejandro Altuna S.A. acoge Sistemas de Gestión de la Calidad homologados por las empresas líderes del sector de automoción y residencial. Actualmente nuestra empresa es reconocida en el mercado como líder en este campo.

LIDER EN EL COMPROMISO POR EL MEDIO AMBIENTE:

En Alejandro Altuna S.A. las buenas prácticas medioambientales son la norma y no la excepción. Nuestro equipo forma parte de un proyecto de empresa respetuoso con el medioambiente y que colabora con el desarrollo sostenible de nuestro entorno.

Alejandro Altuna S.A. fue el primer fabricante mundial de llaves en conseguir en 2000 el certificado ISO 14001 para su Sistema de Gestión. Este Sistema incorpora la política medioambiental, donde se recogen los valores y compromisos de la empresa, así como procedimientos que desarrollan los sistemas de trabajo y garantizan las correctas prácticas medioambientales en todos los ámbitos de la empresa.

LIDER EN SERVICIO:

La realidad de una empresa se demuestra en su capacidad por responder con la máxima celeridad y eficacia a las necesidades y exigencias de los clientes. Se encuentran donde se encuentren. JMA pone a su disposición 5 plantas productivas en localizaciones estratégicas. Además, gracias a su amplia red de filiales y empresas distribuidoras repartidas por todo el mundo, le permite llegar a cualquier cliente, se cual sea su ubicación.



EUSKERA:

LIDERRA TEKNOLOGIAN:

Kalitatearen eta berrikuntzaren aldeko apustua sendoa da, prozesuen automatizazioan nahiz bermean oinarrituta eta epe luzearako inbertsioa eginda.

LIDERRA KALITATEAN:

Kalitatearen arloan, Alejandro Altuna S.A. sektoreko enpresa liderra eta aitzindaria izan da beti. Hona hemen gure kalitate-politikaren oinarriak: prebentzioa, plangintza, etengabeko hobekuntza, bezeroaren poztasuna eta pertsonen partaidetza.

Balio horiek hasiera-hasieratik ezarri dira gure enpresan, eta, instalazio zein makinetan inbertitzeko politika egokiarekin batera, gure arrakastaren arazo nagusia izan dira. Horrez gain, enpresaren lehiakortasuna eta epe luzearako etorkizuna bermatzeko aukera ere eskaini digute.

ISO 9001en arabera kalitate-ziurtagiria ez ezik, Alejandro Altuna S.A. enpresak ibilgailu-industriako eta bizileku-sektoreko enpresa liderrek homologatutako kalitate-kudeaketarako sistemak ere baditu. Gaur egun, merkatuaren arabera, gure enpresa liderra da arlo horretan.

LIDERRA INGURUMENAREKIKO KONPROMISOAN:

Alejandro Altuna S.A. enpresan, ingurumen-arloko jardura egokiak ez dira salbuespena, araua baizik. Gure taldea ingurumena errespetatu eta ingurunearen garapen iraunkorra sustatzen duen enpresa-proiektuaren barruan dago.

2000. urtean, Alejandro Altuna S.A. bere kudeaketa-sistemarako ISO 14001 ziurtagiria lortu zuen lehen giltzagilea izan zen munduan. Ingurumen-politika sistema horren barruan dago kokatuta, eta, bertan, enpresaren balioak zein konpromisoak azaltzen dira, baita lan-sistemak garatu eta enpresako arlo guztietan ingurumen-jardura egokiak bermatzeko prozedurak ere.

LIDERRA ZERBITZUAN:

Edonon daudela ere, bezeroen premiei eta eskakizunei ahalik eta azkarren eta era eraginkorrean erantzuteko daukan gaitasuna da enpresaren errealitatea adierazgarri.

JMAk 5 ekoizpen-lantegi ditu leku estrategikoetan. Gainera, bere filialen sarea zabala denez eta banaketa-enpresak mundu zabalean barreiatuta daudenez, edozein bezeroengana heldu daiteke, edonon dagoela ere.

JMA, EL LIDER

JMA, THE LEADER

ENGLISH:

THE LEADER IN TECHNOLOGY:

Looking for the latest developments to improve the production processes together with a strong investment policy in all our plants to ensure the company's competitiveness and long-term future.

THE LEADER IN QUALITY:

As far as Quality is concerned, Alejandro Altuna S.A. has always been a leading, pioneering company in its sector. Our quality policy is based on prevention and planning, continuous improvement, customer satisfaction and people participation.

These values have been impregnated in our company from the start and have been, together with a good investment policy in terms of equipment and machinery, the main reason behind our success, which moreover enables us to ensure the company's competitiveness and long-term future.

In addition to Quality Certification to ISO 9001, Alejandro Altuna S.A. operates Quality Management Systems approved by the leading companies in the automotive and residential sectors. Our company is currently recognised in the market as a leader in this field.

THE LEADER IN THE COMMITMENT TO THE ENVIRONMENT:

At Alejandro Altuna S.A. best environmental practice is the norm and not the exception. Our team is part of a business project that respects the environment and contributes to the sustainable development of our community.

Alejandro Altuna S.A. was the first key manufacturer in the world to achieve ISO 14001 certification for its management system in 2000. This system incorporates the environmental policy, which includes the company's values and commitments, as well as procedures to set out the work systems and ensure good environmental practice throughout the company.

THE LEADER IN SERVICE:

The efficiency of a company is shown in its capacity to respond with the maximum speed and effectiveness to the needs and requirements of its customers, wherever they are based.

JMA places at your disposal 5 production plants based in strategic locations. Moreover, with its extensive network of associate and distribution companies located throughout the world, the company can reach any customer, wherever based.

FRANÇAIS:

LEADER EN TECHNOLOGIE:

Un pari résolu sur la qualité et l'innovation basé sur l'automatisation et la garantie des procédés, soutenu par une vocation d'investissement à long terme.

LEADER EN QUALITÉ:

Dans le domaine de la Qualité, Alejandro Altuna S.A. a toujours été une entreprise pionnière et leader de son secteur. Notre politique de qualité est assise sur la prévention et la planification, l'amélioration continue, la satisfaction du client et la participation des personnes. Ces valeurs irriguent notre entreprise depuis sa création. Soutenues par une politique constante d'investissement en installations et machines, elles expliquent notre succès et, de plus, nous permettent d'assurer la compétitivité de l'entreprise et donc notre futur à long terme.

Bénéficiant de la Certification de Qualité selon la norme ISO 9001, Alejandro Altuna S.A. s'appuie sur des systèmes de gestion de la qualité homologués par les principaux constructeurs, aussi bien automobiles que du bâtiment. Aujourd'hui, notre entreprise est reconnue par le marché comme le leader du secteur.

LEADER EN ENGAGEMENT ENVIRONNEMENTAL:

Pour Alejandro Altuna S.A., les bonnes pratiques environnementales sont la règle et non l'exception. Notre équipe fait partie d'un projet entrepreneurial respectueux de l'environnement qui collabore au développement durable de notre milieu.

Alejandro Altuna S.A. a été le premier fabricant mondial de clés à obtenir, dès 2000, le certificat ISO 14001 pour son système de gestion. Ce système comporte deux piliers: la politique environnementale, où sont définis les valeurs et les engagements de l'entreprise, et les procédures qui développent les systèmes de travail et qui garantissent les bonnes pratiques environnementales dans tous les domaines d'activité.

LEADER EN SERVICE:

La réalité d'une entreprise se démontre par sa capacité à répondre le plus promptement et le plus efficacement possible aux besoins et aux exigences des clients, où qu'ils se trouvent.

JMA place à leur disposition 5 sites de production situés dans des lieux stratégiquement choisis. De plus, grâce à notre vaste réseau de filiales et de distributeurs répartis dans le monde entier, nous pouvons toucher tous nos clients, où qu'ils soient.

DEUTSCH:

FÜHREND IN TECHNOLOGIE:

Ein solider Einsatz für die Qualität und die Innovation, der sich auf Automatisierung und Prozesssicherheit sowie eine langfristige Investitionsgrundlage stützt.

FÜHREND IN QUALITÄT:

Auf dem Gebiet der Qualität war Alejandro Altuna S.A. stets ein führendes und bahnbrechendes Unternehmen des Sektors. Unsere Qualitätspolitik basiert auf Prävention und Planung, ständiger Verbesserung, Kundenzufriedenheit und Einbeziehung der Mitarbeiter.

Diese Werte sind schon seit den Anfängen fester Bestandteile unseres Unternehmens. Gemeinsam mit einer angemessenen Politik der Investition in Anlagen und Maschinenpark waren sie der wichtigste Grund für unseren Erfolg und sichern darüber hinaus die Wettbewerbsfähigkeit des Unternehmens und damit seine langfristige Zukunft.

Neben der Qualitätszertifizierung nach ISO 9001 verfügt Alejandro Altuna S.A. über Qualitätsmanagementsysteme, die von den führenden Automobil- und Wohnungsbauunternehmen zugelassen sind. Derzeit ist unser Unternehmen auf dem Markt für seine führende Position im Bereich Qualität bekannt.

FÜHREND IM UMWELTSCHUTZ:

Bei Alejandro Altuna S.A. sind gute Umweltschutzpraktiken die Regel, nicht die Ausnahme. Unsere Mitarbeiter sind Teil des Projekts des umweltfreundlichen Unternehmens, das sich für die nachhaltige Entwicklung unserer Umwelt einsetzt.

Alejandro Altuna S.A. erhielt im Jahr 2000 als weltweit erster Hersteller von Schlüsseln das Zertifikat ISO 14001 für sein Managementsystem. Dieses System umfasst die Umweltpolitik, die die Werte und Verpflichtungen des Unternehmens sowie die Verfahren für die Herstellungssysteme festlegt, und die korrekten Umweltschutzpraktiken in allen Unternehmensbereichen garantiert.

FÜHREND IM SERVICE:

Die Realität eines Unternehmens zeigt sich in seiner Fähigkeit, in optimalem Zeitrahmen und mit maximaler Effizienz auf die Bedürfnisse und Anforderungen der Kunden zu reagieren, unabhängig davon, wo diese sich befinden.

JMA verfügt über 5 Fertigungsstätten an strategischen Standorten. Dank eines über die ganze Welt ausgedehnten Netzes von Filialen und Vertriebspartnern ist das Unternehmen immer in der Nähe seiner Kunden, egal wo.

**14 COMPAÑÍAS EN 14 PAÍSES
400 PERSONAS Y
MÁS DE 450 MILLONES DE LLAVES AL AÑO
EN MÁS DE 100 PAÍSES EN TODO EL MUNDO.**

**El potencial de JMA en el mundo está cimentado a través de sus plantas productivas y filiales comerciales en Europa, América del Norte y del Sur, Asia y África.
La internacionalización es una estrategia prioritaria en JMA.**

JMA MUNDUAN

14 konpainia 14 herrialdean; 400 pertsona eta 450 milioitik gora giltza urtean, mundu zabaleko 100etik gora herrialdean.

JMA enpresak ahalmena du munduan, ekoizpen-lantegiak eta filial komertzialak dituelako Europan, Ipar Amerikan, Hego Amerikan, Asian eta Afrikan.
Izan ere, nazioarteko bihurtzea lehentasunezko estrategia da JMArentzat.

JMA WORLDWIDE

14 companies in 14 countries; 400 people and over 450 million keys sold in more than 100 countries all over the 5 continents

JMA's potential worldwide is based on its production plants and commercial subsidiaries in Europe, North and South America, Asia and Africa.
Globalisation is a priority strategy for JMA.

JMA DANS LE MONDE

14 sociétés dans 14 pays ; 400 personnes et plus de 450 millions de clés vendues chaque année dans plus de 100 pays de quatre continents

Le potentiel de JMA dans le monde est solidement ancré dans un réseau de production et de distribution qui couvre l'Europe, les deux Amériques, l'Asie et l'Afrique.
L'internationalisation est une stratégie prioritaire pour JMA.

JMA IN DER WELT

14 Unternehmen in 14 Ländern; 400 Personen und über 450 Millionen Schlüssel pro Jahr in über 100 Ländern der ganzen Welt.

Das Leistungspotenzial von JMA in der ganzen Welt wird durch seine Produktionsstätten und Handelsfilialen in Europa, Nord- und Südamerika, Asien und Afrika konsolidiert. Internationalisierung ist eine vorrangige Strategie von JMA.



● **PLANTAS PRODUCTIVAS**
MANUFACTURING PLANTS

● **CENTROS DE DISTRIBUCIÓN**
DISTRIBUTION CENTERS

JMA EN EL MUNDO

JMA WORLDWIDE

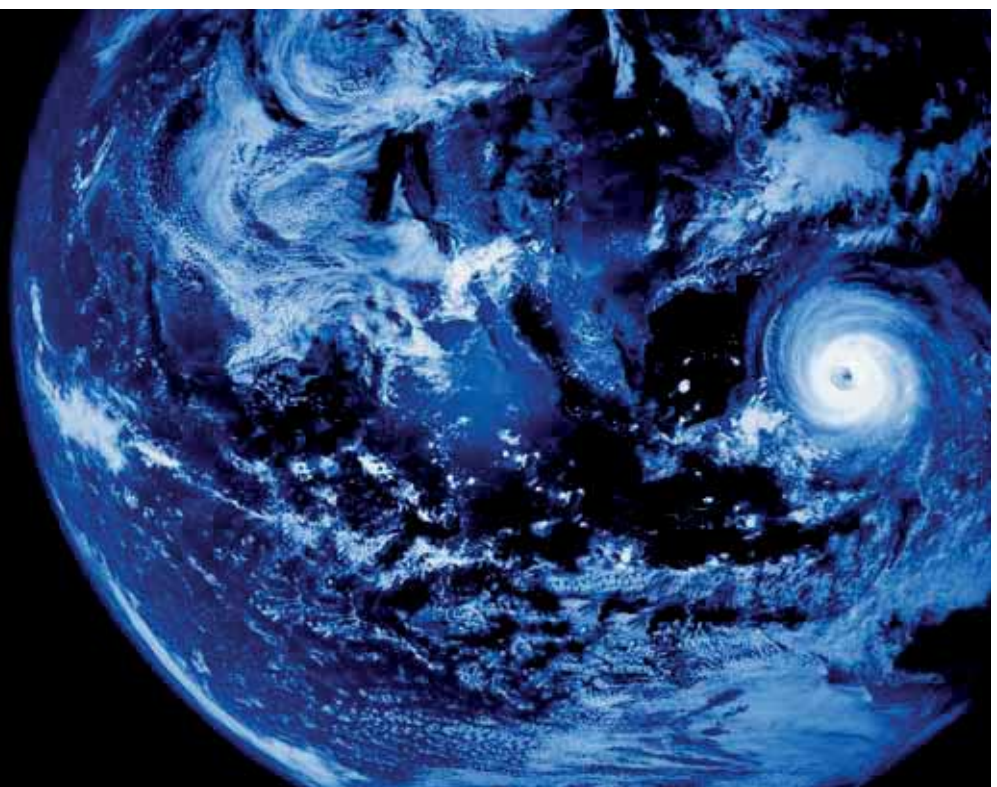

THE KEY TO EXCELLENCE
GLOBALLY UNLOCKING MILLIONS OF DOORS DAILY

ESPAÑOL

- 1 MARCA PRINCIPAL
- 2 CABEZA
- 3 CUELLO
- 4 TOPE
- 5 PALETÓN
- 6 PUNTA
- 7 UTILIZACIÓN
- 8 NOMENCLATURA DE PERFIL ORIGINAL
- 9 PERFIL IZQUIERDO
- 10 PERFIL DERECHO
- 11 REFERENCIA
- 12 MARCAS SECUNDARIAS
- 13 SERIES

1 ABSA

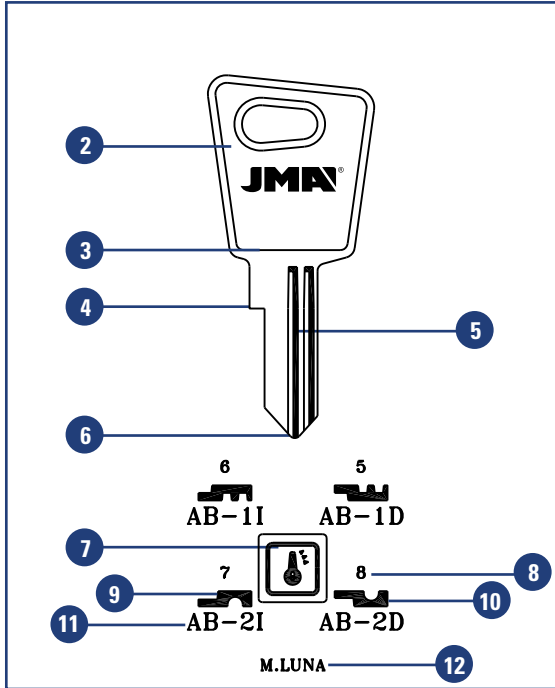

1 VACHETTE

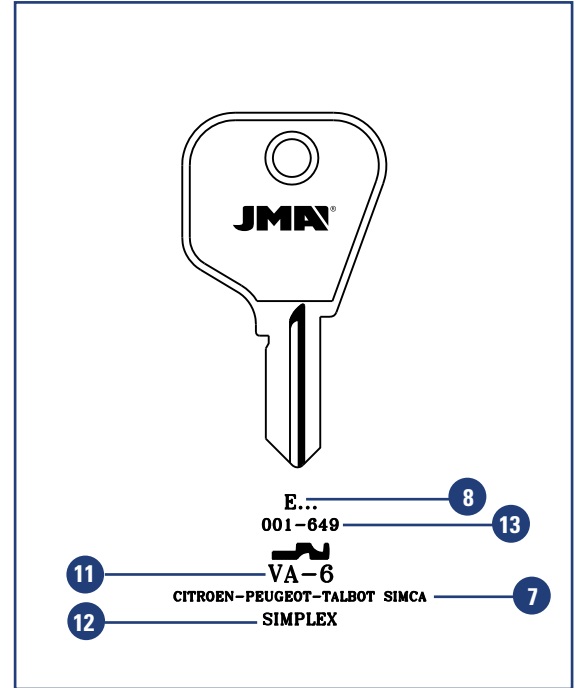

EUSKERA	ENGLISH	FRANÇAIS	DEUTSCH
1 MARKA NAGUSIA	1 MAIN BRAND	1 MARQUE PRINCIPALE	1 HAUPTPRÄGUNG
2 BURUA	2 HEAD	2 TÊTE	2 KOPF
3 LEPOA	3 NECK	3 COU	3 HALS
4 TOPEA	4 SHOULDER	4 ARRÊT	4 ANSCHLAG
5 BELARRIA	5 BLADE	5 CANON	5 SCHAFT
6 PUNTA	6 TIP	6 POINTE	6 SPITZE
7 ERABILERA	7 USE	7 UTILISATION	7 VERWENDUNG
8 JATORRIZKO PROFILAREN IZENDEGIA	8 ORIGINAL PROFILE	8 PROFIL ORIGINAL	8 ORIGINALPROFIL
9 EZKERREKO PROFILA	9 LEFT PROFILE	9 PROFIL GAUCHE	9 LINKSPROFIL
10 ESKUINEKO PROFILA	10 RIGHT PROFILE	10 PROFIL DROIT	10 RECHTSPROFIL
11 ERREFERENTZIA	11 REFERENCE	11 RÉFÉRENCE	11 BEZEICHNUNG
12 BIGARREN MAILAKO MARKAK	12 SECONDARY BRAND	12 MARQUE SECONDAIRE	12 2. PRÄGUNG
13 SERIEAK	13 SERIES	13 CODE	13 SERIE

DESCRIPCIÓN Y TERMINOLOGÍA

KEY DESCRIPTION AND TERMINOLOGY

ESPA-

- 1 CABEZA
- 2 CUELLO
- 3 DIÁMETRO DE LA CAÑA
- 4 CAÑA
- 5 LONGITUD A
- 6 PALETON
- 7 PERFIL MACHO
- 8 REFERENCIA
- 9 MARCA ORIGINAL
- 10 PERFIL HEMBRA

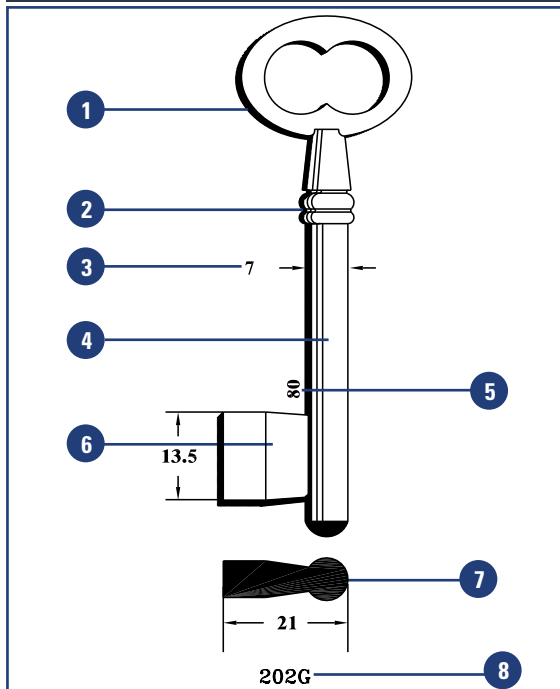

9 — ORENGO

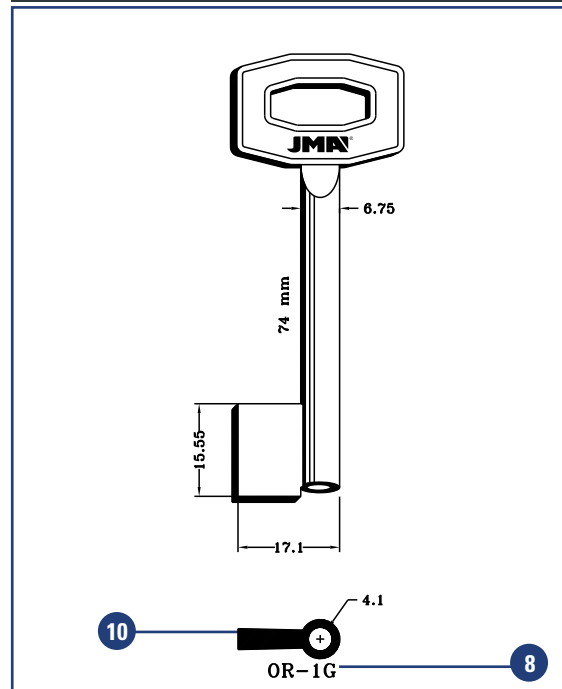

EUSKERA	ENGLISH	FRANÇAIS	DEUTSCH
1 BURUA	1 HEAD	1 TÊTE	1 KOPF
2 LEPOA	2 NECK	2 COU	2 HALS
3 ZIRIAREN DIAMETROA	3 SHANK DIAMETER	3 DIAMETRE DU CANON	3 HALM- DURCHMESSER
4 ZIRIA	4 SHANK	4 CANON	4 HALM
5 A LUZERA	5 LENGTH A	5 LONGUEUR A	5 LÄNGE A
6 BELARRIA	6 BIT	6 PANNETON	6 BART
7 PROFIL ARRA	7 PIN BIT PROFILE	7 PROFIL MALE	7 SCHWEIFUNG
8 ERREFERENTZIA	8 REFERENCE	8 RÉFÉRENCE	8 BEZEICHNUNG
9 JATORRIZKO MARKA	9 ORIGINAL BRAND	9 MARQUE ORIGINALE	9 ORIGINAL- PRÄGUNG
10 PROFIL EMEA	10 PIPE BIT PROFILE	10 PROFIL FEMELLE	10 GEBOHRT

ALP.

Llave fabricada en alpaca

Alpakaz egindako giltza
Key available in nickel silver
Clé fabriquée en maillechort
Schlüssel auch in Neusilber lieferbar

LAT.

Llave disponible también en latón

Giltza, letoizkoa ere eskuragarria
Key also available in brass
Clé aussi disponible en laiton
Schlüssel auch in Messing lieferbar

COL.

Llave disponible también con cabeza de plástico en colores

Giltza hau koloretako plastikozko buruarekin ere eskuragarria

Key also available with coloured plastic head

Clé aussi disponible avec tête plastifiée en couleurs

Schlüssel auch mit farbigem Plastikkopf lieferbar

ALU.

Llave disponible también en aluminio

Giltza, aluminioan ere eskuragarria
Key also available in aluminium
Clé aussi disponible en aluminium
Schlüssel auch in Aluminium lieferbar

ZAM.

Llave fabricada solamente en zamak

Zamakez soilik egindako giltza
Key only available in zamak
Clé aussi disponible en zamak
Schlüssel nur aus Zamak lieferbar



35

Llave de utilizacion en candados

Giltzarrapoetan erabiltzeko giltzak
Key for padlocks
Clé pour cadenas
Schlüssel für Hangschlösser



Llave de utilización en cerraduras auxiliar

Sarraila osagarrietan erabiltzeko giltzak
Key for cam locks
Clé pour petite serrurie
Schlüssel für Hebelschlösser



Llaves para motocicletas

Motozikleta giltzak
Key for motorcycles
Clé pour motocyclettes
Schlüssel für Motorräder



Llave para tapón de gasolina

Gasolina-tapoietarako giltza
Key for fuel cap
Clé pour bouchon d'essence
Schlüssel für Tankdeckel



Llave para camión

Kamioiko giltza
Key for lorries
Clé pour camion
Schlüssel für Lastkraftwagen



Alarma

Alarma
Alarm
Alarme
Alarm



Llaves gorja con acabado en color natural

Gorja giltzak berezko kolorezko akaberarekin
Bit key blank with natural colour finishing
Clé à gorges avec finition en couleur naturel
Chubbsschlüssel in naturfarben Ausführung



Llaves gorja con acabado en negro antiguo

Gorja giltza, beltz zaharkitu akaberarekin
Bit key blank with old black finishing
Clé à gorges avec finition en vieux noir
Chubbsschlüssel in altschwarzer Ausführung

NACIONALIDAD - NAZIONALITATEA - NATIONALITY - NACIONALITÉ - NATIONALITÄT

AUSTRIA
AUSTRALIA
BELGIUM
BRAZIL
CANADA
SWITZERLAND
GERMANY
DENMARK

A
AUS
B
BR
CDN
CH
D
DK

ALGERIA
SPAIN
ESLOVAKIA
EGYPT
FRANCE
GREAT BRITAIN
GREECE
HUNGARY

DZ
E
ES
ET
F
GB
GR
H

HONG KONG
CROATIA
ITALY
ISRAEL
INDIA
EIRE
JAPAN
KOREA

HK
HR
I
IL
IND
IRL
J
K

SÍMBOLOS

SYMBOLS

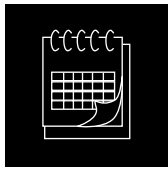

Calendario

Egutegia
Calendar
Calendrier
Kalender



Contacto auto

Autoko kontaktua
Engine ignition
Contact auto
Zündschloss Pkw

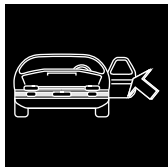

Puerta

Atea
Door lock
Portière
Türe

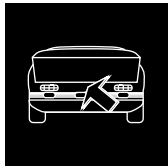

Maletero/Puerta trasera

Maletategia/Atzeko atea
Boot/Hatchback
Coffre/Portière postérieure
Kofferraum/Hecktür



Tapón de gasolina

Gasolina-tapoia
Petrol cap
Bouchon réservoir
Benzintankverschluss

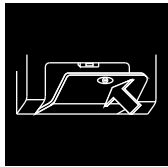

Guantera

Eskularru-kutxa
Drawer
Tiroir
Schublade

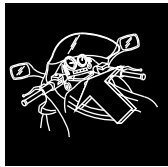

Contacto moto

Moto-kontaktua
Motorbike ignition
Contact moto
Zündschloss Motorrad

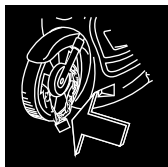

Bloqueo moto

Moto-blokeoa
Motorbike disc lock
Bloquage moto
Bremsenschloss Motorrad

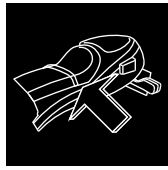

Sillin

Zela
Cycle seat
Selle
Sattel

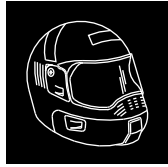

Casco

Kaskoa
Helmet
Casque
Helm

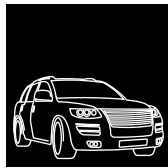

Automovil / camioneta

Automobila / kamioneta
Car / Pick-up trucks
Voiture / Camionnette
Auto / Kleintransporter

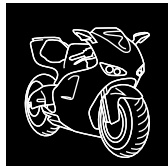

Motocicleta

Motozikleta
Motorcycle
Motocyclette
Motorrad



Camión

Kamioia
Trucks
Camion
Lkw

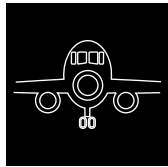

Avión

Hegazkina
Aeroplane
Avion
Flugzeuge

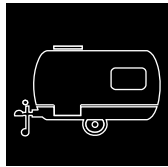

Caravana

Karabana
Caravans
Caravane
Wohnwagen

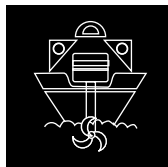

Motor marino

Itsas motorra
Boat engines
Moteur de bateau
Schiffsmotoren

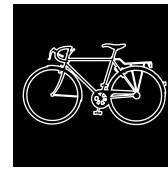

Bicicleta

Bizikleta
Bicycle
Bicyclette
Fahrräder

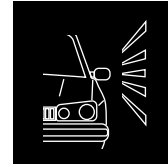

Alarma

Alarma
Alarm
Alarme
Alarm

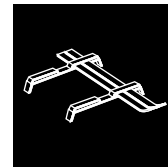

Portaesquis

Eski-euskarria
Ski holder
Porte ski
Skiträger

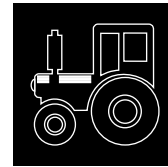

Tractor

Traktorea
Tractor
Traktor
Landmaschinen

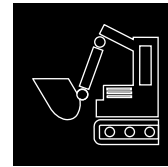

Escavadora

Hondeatzailea
Earth moving machine
Machine déplacement de terre
Baumaschinen



Carretilla elevadora

Orga jasotzailea
Forklift
Clark
Gabelstapler

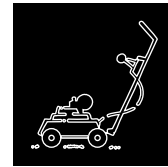

Corta cesped

Belarra mozteko makina
Lawn-mower
Tondeuse
Rasenmäher



Alarma - llave

Alarma - giltza
Alarm - key
Alarme - clef
Alarm - Schlüssel

KUWAIT
MEXICO
NORWAY
THE NETHERLANDS
PORTUGAL
PERU
POLAND
ARGENTINA

KW
MEX
N
NL
P
PE
PL
RA

TAIWAN
CHILE
CHEKIA
RUMANIA
SWEDEN
FINLAND
SLOVENIA
RUSIA

RC
RCH
RCZ
RU
S
SF
SLO
RUS

CHINA
TUNISIA
UNITED STATES OF AMERICA
YUGOSLAVIA
VENEZUELA
ZAMBIA

TJ
TN
USA
YU
YV
Z

LLAVES

GILTZAK

KEYS

CLES

SCHLÜSSEL



SUPLEMENTO-SUPPLEMENT 2011.C10

THE KEY TO EXCELLENCE
GLOBALLY UNLOCKING MILLIONS OF DOORS DAILY

ÍNDICE GENERAL

AURKIBIDE OROKORRA • GENERAL INDEX • INDEX GENERALE • GESAMTVERZEICHNIS

REF.	PAG.
3M-1D	1
A	
ABU-57	1
ABU-73D	1
ABU-74	1
ABU-74D	1
ABU-75D	1
ABU-76	1
ABU-77	1
ABU-78	1
ABU-79	1
ABU-80	1
ABU-81	1
AGA-48	1
AGA-49	1
AGA-50	2
AGA-51	2
AGA-52	2
AS-28	2
AS-MG5	2
AZ-37	2
AZ-37D	2

B	
BAB-17D	2
BH-8	20
BK-16/ 1	2
BK-16/ 2	2
BK-16/ 3	2
BK-16/ 4	2
BK-16/ 5	2
BK-16/ 7	2
BK-16/ 9	2
BK-16/10	2
BK-16/13	2
BK-16/14	2
BK-16/15	2
BK-16/16	2
BK-16/17	2
BK-16/18	2
BK-16/19	2
BK-16/20	2
BK-16/21	2
BK-16/23	2
BK-17/1PZ	3
BK-17/2PZ	3
BK-17/5PZ	3
BK-17/6PZ	3

REF.	PAG.
BK-17/7PZ	3
BK-17/8PZ	3
BK-17/9PZ	3
BK-17D/1	3
BK-17D/1PZ	3
BK-17D/2	3
BK-17D/2PZ	3
BK-17D/3	3
BK-17D/3PZ	3
BK-17D/4	3o
BK-17D/4PZ	3
BK-17D/5	3
BK-17D/6	3
BK-17D/7	3
BK-17D/8	3
BK-17D/9	3
BK-18/ 1	3
BK-18/ 2	3
BK-18/ 3	3
BK-18/ 4	3
BK-18/ 5	3
BK-18/ 6	3
BK-18/ 7	3
BK-18/ 9	3
BK-18/10	3
BK-18/11	3
BK-18/13	3
BK-18/14	3
BK-18/15	3
BK-18/16	3
BK-18/17	3
BK-18/18	3
BK-18/20	3
BK-18/21	3
BK-18/22	3
BK-18/23	3
BK-18/24	3
BK-18/25	3
BK-18/26	3
BK-18/27	3
BK-18/28	3
BK-18/29	3
BK-18/30	3
BK-18/31	3
BK-18/32	3
BK-18/33	3
BK-18/34	3
BK-19/ 1	3
BK-19/ 2	3
BK-19/ 4	3
BK-19/ 5	3

REF.	PAG.
BK-19/ 6	3
BK-19/ 7	3
BK-19/ 8	3
BK-19/10	3
BK-19/11	3
BK-19/12	3
BK-19/13	3
BK-19/15	3
BK-19/16	3
BK-19/19	3
BK-19/20	3
BK-19/21	3
BK-19/23	3
BK-19/25	3
BK-19/26	3
BK-19/27	3
BK-19/31	3
BK-19/32	3
BK-20	4
BLU-2X	24
BMB-1	4
BMB-2	4
BSS-6D	4
BSS-7D	4
BTV-3	4
BUR-26D	4
BUR-27D	4
BUR-28	4
BUR-29	4
BUR-29D	4
BUR-30D	20
BUR-31D	4
BUR-32D	4
BUR-33	5

C	
CAB-1D	5
CE-130	5
CE-131D	5
CE-132/15	5
CE-132/16	5
CE-132/17	5
CE-132/18	5
CE-132/25	5
CE-132/26	5
CE-132/27	5
CE-132/35	5
CE-132/36	5
CE-132/37	5
CE-132/38	5

REF.	PAG.
CE-132/45	5
CE-132/46	5
CE-134	5
CE-135D	5
CI- 3PG	24
CI-34D	6
CI-62D	5
CI-63	6
CI-63D	6
CI-64D	6
CI-65	6
CI-66D	6
CIN-1	5
CIN-1D	5
CIS-7D	5
COR- 24D	6
COR- 62	6
COR-115D	6
COR-153	6
CR-19G	24
CRO-1G	24

D	
DAE-3D	20
DAE-4D	20
DOM-27/12	6
DOM-27/13	6
DOM-27/16	6
DOM-27/19	6
DOM-27/35	6
DOM-28D	6
DOM-53D	7
DOM-54D	7
DOM-55	7
DOM-55D	7
DOM-56D	7
DOM-57D	7
DOM-58D	7
DOM-59	7
DOM-60D	7
DOM-61	7
DOM-62D	7
DOM-63D	7
DOM-64D	7
DOM-65	7
DOM-66D	7
DOM-67D	7
DOM-68	7
DR-1	6

ÍNDICE GENERAL

GENERAL INDEX

REF.	PAG.
------	------

E

ESS-9D	7
EU-12	7
EU-13D	7
EV-19	8
EV-20D	8
EV-23D	7
EXS-2D	8
EXS-3	8
EXS-3D	8
EXS-4D	8
EXS-5	8
EXS-5D	8
EXS-6	8

F

FAC-24	8
FI-16P1	21
FLO-2D	20
FRI-3	8
FTH-30	8
FTH-31	8

G

GE-21	8
GE-21D	8
GEA-6D	8
GEA-7D	8
GH-2	20
GH-3	20
GTV-10	9
GTV-11	9
GW-1D	20

H

HD-4D	20
HOND-24DP	20
HOND-43	20
HOND-43D	20
HOND-43DP	20
HOND-43P	20
HTE-1D	9
HU-NW	20
HUW-2	9

I

ILS-1	10
IS-18D	11
IS-19D	11
ISU-3D	21

REF.	PAG.
------	------

J

JPM-10D	11
JWL-9	11
JWL-9D	11
JWL-10D	11
JWL-11D	11

K

KE-5	11
KFV-C	11
KFV-D	11
KFV-E	11
KFV-F	11
KFV-L	11
KFV-M	11
KFV-N	11
KFV-O	11

L

LF-43	12
LIN-25	11
LIN-25D	11
LIT-2GD	11
LT-1	12

M

MAG-2DP	12
MCM-27	12
MLM-5D	12
MOD-1DP	21
MPA-1G	24
MT-3P1G	25
MT-5P1G	25
MT-6P1G	25
MT-8P1G	25
MT-9P1G	25
MT-10P1G	25
MT-18G	25
MUL-T 8P1	12
MUL-T 9P1	12
MUL-T11P1	12

N

NE-61D	21
NE-62	21
NE-63D	21

R

RU-19D	12
--------	----

REF.	PAG.
------	------

S

SER-3D	12
STE-13D	13
STE-14D	13
STUV-3	13

T

TC-1	13
TIT-2GD	13
TIT-8GD	13
TOK-21D	14
TOK-37	14
TOK-38	14
TOK-39	14
TOK-40	14
TOK-41	14
TOK-42	14
TOK-43	14
TOK-44	14
TOK-44D	14
TOK-45	14
TOK-45D	14
TOK-46	14
TOK-47	14
TOK-47D	14
TOK-48	14
TOK-48D	14
TOK-49	14
TOK-50	14
TOK-51	14
TOK-52	14
TOK-53	14
TOK-54	14
TOK-55	14
TOK-56D	13
TOK-58	13
TOK-59	13
TOK-60	13
TOK-61	13
TOK-62	14
TOK-62D	14
TOK-63	14
TOK-64	14
TOK-65	14
TOK-66	14
TOK-67	14
TOK-68	14
TOK-69	14
TOK-70	14
TOK-71	14
TOK-72	14
TOK-73	14
TOK-74	14
TOK-75	13
TOK-76	13

REF.	PAG.
------	------

TOK-77	13
TOK-78	13
TOYO-12DP1	21
TOYO-37D	21
TRL-2	14
TX-2	14

U

U-26	14
U-26D	14

V

VI-15	15
VI-16D	15

W

WE-6D	15
WIL-24	15
WIL-25	15
WIL-26	15
WIL-27	15
WIL-28	15
WIL-29	15
WIL-30	15
WIL-31D	15
WIL-32	15
WIL-33D	15
WIL-34D	15
WIL-35D	15
WIL-36D	15
WIL-37D	15
WIL-38D	15
WIL-39D	15
WIL-40D	15
WIL-41D	15
WIL-43D	15
WIL-44	15
WIL-45D	15
WIL-46D	15
WIL-47D	15
WIL-48D	15
WIL-49D	15
WIL-50D	15
WIL-51D	15
WIL-52	15
WIL-53	15
WIL-54	15
WIL-55	15
WIL-56	15
WIL-57D	15
WNC-1	15

REF.	PAG.
------	------

Y

YA- 57	15
YA- 57D	15
YA- 58D	15
YA- 59D	15
YA- 91	15
YA- 91D	15
YA- 92	15
YA- 92D	15
YA- 94	15
YA- 95	15
YA- 97D	16
YA- 98D	16
YA- 99D	16
YA-100D	16
YA-101D	16
YA-102D	16
YA-103D	16
YA-108	16
YA-111	16
YA-112	16
YA-113	16
YA-142D	16
YA-186D	16
YA-206D	16
YA-208D	16
YA-209D	16
YA-210D	16
YA-212D	16
YA-216	17
YA-217	17
YA-219	17
YA-220	17
YA-221	17
YA-225	17
YA-226	17
YA-227	17
YA-228	17
YA-229	17
YA-232	17
YA-272D	16
YA-273D	16
YAR-3	17
YUH-1D	17
YUH-2D	17
YW-1P	17-21

REF.	PAG.
------	------

Z

ZA-5DP	21
ZE- 14D	10
ZE- 15	9
ZE- 16D	9
ZE- 17D	9
ZE- 18D	9
ZE- 19	9
ZE- 20	9
ZE- 21D	9
ZE- 22	9
ZE- 23D	10
ZE- 24D	10
ZE- 25D	10
ZE- 26D	10
ZE- 27D	10
ZE- 28D	10
ZE- 29D	10
ZE- 30D	10
ZE- 31D	10
ZE- 32D	10
ZE- 33D	10
ZE- 34D	10
ZE- 35	10
ZE- 35D	10
ZE- 36D	9
ZE- 37D	9
ZE- 38	9
ZE- 39	9
ZE- 40D	9
ZE- 41	9
ZE- 42	9
ZE- 43	9
ZE- 44D	9
ZE- 45D	9
ZE- 46	9
ZE- 47D	10
ZE- 48D	10
ZE- 49D	10
ZE- 50D	10
ZE- 51D	10
ZE- 52D	10
ZE- 53D	10
ZE- 54D	10
ZE- 55D	10
ZE- 56D	10
ZE- 57D	10
ZE- 58D	10
ZE- 59D	10
ZE- 60D	10
ZE- 61D	10
ZE- 62D	10
ZE- 63D	10
ZE- 64D	10
ZE- 65D	10
ZE- 66D	10

REF.	PAG.
------	------

ZE- 67D	10
ZE- 68D	10
ZE- 69D	10
ZE- 70D	10
ZE- 71D	9
ZE- 72	9
ZE- 73	9
ZE- 74	9
ZE- 75	9
ZE- 76D	9
ZE- 77D	9
ZE- 78D	9
ZE- 79	9
ZE- 80	9
ZE- 81	9
ZE- 82	9
ZE- 83	9
ZE- 84	9
ZE- 85	9
ZE- 86D	9
ZE- 87	9
ZE- 88	9
ZE- 89	9
ZE- 90	9
ZE- 91D	9
ZE- 92D	9
ZE- 93D	9
ZE- 94D	9
ZE- 95D	9
ZE- 96D	9
ZE- 97D	9
ZE- 98	9
ZE- 99	9
ZE-100	9
ZE-101	9
ZE-102	9
ZE-103	9
ZE-104D	9
ZE-105D	10
ZE-106D	10
ZE-107D	10
ZE-108D	10
ZE-109D	10
ZE-110D	10
ZE-111D	10
ZE-112D	10
ZE-113D	10
ZE-114D	10
ZE-115D	10
ZE-116D	10
ZE-117D	10
ZE-118	9
ZE-119D	9
ZE-120	9
ZE-121D	9
ZE-122D	9
ZE-123D	9

REF.	PAG.
------	------

ZE-124	9
ZE-125D	10
ZE-126D	10
ZE-127D	10
ZE-128	9
ZE-129D	9
ZE-130	9
ZE-131	9
ZE-132D	9
ZE-133D	9
ZE-134	9
ZE-135D	9
ZE-136D	10
ZE-137	9
ZE-138	9
ZE-139D	9
ZE-140	9
ZE-141D	10
ZE-142	9
ZE-143	9
ZE-144D	9
ZE-145D	10
ZE-146D	10
ZE-147D	10
ZE-148D	10

ÍNDICE DE MARCAS

BRAND INDEX

ÍNDICE DE MARCAS

MARKEN AURKIBIDEA • BRAND INDEX • INDEX MARQUE • HAUPTMARKE

MARCA - MARKA - MAIN MARQUE - MARKE	PÁG. - ORRIA - PAGE - PAGE - SEITE
--	---------------------------------------

3M	1
----	---

A

ABUS	1 6 17 21
AGA	1 2
ALA	6
ASSA	2
ATRA	6
AZBE	2

B

BAB	2 7
BANE SEKULIC	4
BKS	2 3 4 16 17
BLACK & DECKER	6
BLUMA	24
BMB	4
BOSCH	20
BSS	4
BTV	4
BURG	4 5 20

C

CAB	5
CAS CISMA	5
CES	5
CHANGE-O-MATIC	6
CINA	5
CISA	1 5 6 24
COMBA	11
CORBIN	6
CR	24
CRONOS	24

D

DAEWOO	20
DIERRE	6
DOM	6 7 12 13

E

ESS	7
EURO LOCKS	7
EVVA	7 8
EXPRES	8

F

FAC	8
-----	---

MARCA - MARKA - MAIN MARQUE - MARKE	PÁG. - ORRIA - PAGE - PAGE - SEITE
--	---------------------------------------

FAI	15
FCV	11
FEDERAL	8
FLIETHER	11
FLORA	20
FRIPA	8
FTH	8

G

GAMMA	12
GE GE	4 8 13
GERA	8
GEWIRU	7
GEWU	20
GHE	20
GIESCHE	11
GIOBERT	21
GOTZ	11
GRAF	11
GTV	9 11

H

HAMPTON	14
HARLEY DAV.	20
HONDA	20
HSA	11
HTEC	9
HUF	20
HUWIL	9

I

IKON	9 10
ILS	10
ISEO	11 14
ISUZU	21

J

JOWIL	11
JPM	1 11

K

KASSBOHRER	20
KESO	11
KFV	11
KOLB	20

MARCA - MARKA - MAIN MARQUE - MARKE	PÁG. - ORRIA - PAGE - PAGE - SEITE
--	---------------------------------------

L	
LAPORTE	20
LINCE	11
LITTO	11
LOWE & FLETCHER	12
LT	12

M

MAGNUM	7
MOFA	12
MOTTURA	14
MP	14

N

NEIMAN	21
NICO	11

P

PEROHAUS	20
POS	20
PZ	3

R

RUKO	12
RUNO	20

S

SCHUCO	1 11
SEN	11
SERRALLER	12
SISO	8
STEM	13
STUV	7 12 13

T

TECON	13
THIRARD	8
TIEFENTHAL	9
TITAN	13
TOK WINKHAUS	13 14
TOYOTA	21
TRELOCK	13 14
TRW-SIPEA	21

MARCA - MARKA - MAIN MARQUE - MARKE	PÁG. - ORRIA - PAGE - PAGE - SEITE
--	---------------------------------------

U

UNIVERSAL	14
-----------	----

V

VIRO	15
------	----

W

WECO	20
------	----

WELKA	15
-------	----

WILKA	15
-------	----

WINLOCK	15
---------	----

MARCA - MARKA - MAIN MARQUE - MARKE	PÁG. - ORRIA - PAGE - PAGE - SEITE
--	---------------------------------------

Y

YALE	3 15 16 17
------	------------

YARDENI	17
---------	----

YUN HUAN	17
----------	----

YWS	17 21
-----	-------

Z

ZADI	21
------	----

ZUNDAPP	20
---------	----

LLAVES PLANAS PARA CERRADURAS DE CILINDRO

SARRAILA ZILINDRIKOTARAKO GILTZA ZAPALAK

CYLINDER KEYS

CLÉS POUR CYLINDRES

ZYLINDERSCHIÜSSEL



THE KEY TO EXCELLENCE

GLOBALLY UNLOCKING MILLIONS OF DOORS DAILY

3M

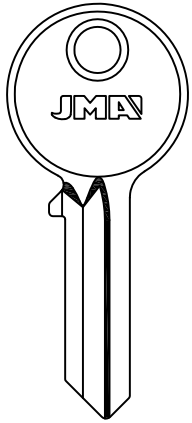

3M-1D

ABUS

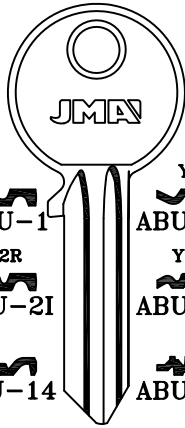

ABU-1

Y2R
ABU-2I

ABU-14

ABU-44

ABU-46

Y1
ABU-1D

Y2L
ABU-2D

ABU-7D

ABU-43D

ABU-46D

ABU-49

ABU-53

X4S
ABU-55

ABU-67

ABU-69

NEW
ABU-74

X2S **NEW**
ABU-76

ABU-52D

ABU-55D

ABU-67D

ABU-71D

NEW
ABU-74D

NEW
ABU-77

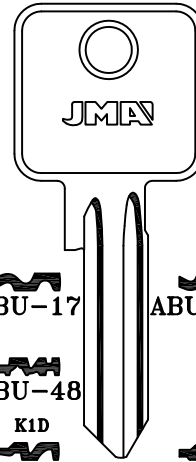

ABU-17

ABU-48

K1D
ABU-70

NEW
ABU-77

ABU-17D

ABU-58D

NEW
ABU-80

CISA-JPM-SCHUCO

CISA

PARA-FOR:

3M (PRC)
ABUS (D)
AGA (E)

ABUS

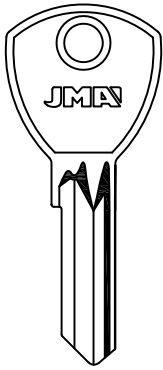

8.25
2.85
ABU-61

ABU-63

ABU-66

NEW
ABU-81

LAT.

LAT.

NEW
ABU-57 ABU-57D

ABU-73D

ABU-75D

ABUS

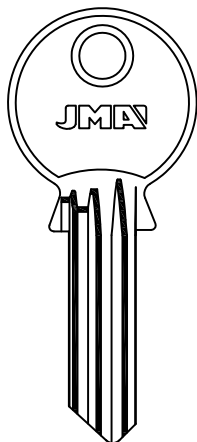

LAT.

004
ABU-78

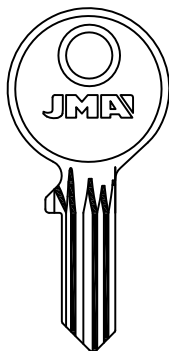

AL
ABU-79

AGA

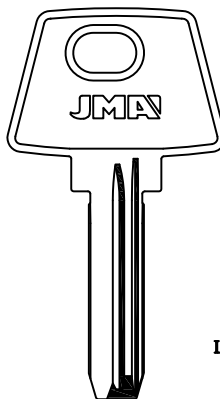

LAT.

7
2.35
AGA-38

NEW
AGA-42 AGA-48

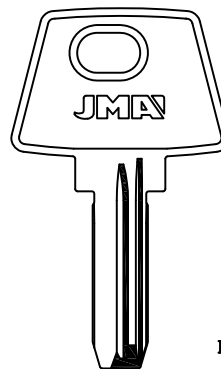

LAT.

7
2.35
AGA-39

NEW
AGA-43 AGA-49

JMA

Copyright by Alejandro Altuna S.A. 2012



ATENCIÓN: Concerniente a las marcas y denominaciones comerciales ver nota en índice.
ATTENTION: Concerning the marks and commercial denominations see note in index.
ATTENTION: Concernant les marques et dénominations commerciales voir la note dans l'index.
ACHTUNG: Beziehen auf die Marke und Handelsname sehen sie die Notiz im Index.

PARA-FOR: AGA

AGA (E)
 ASSA (S)
 AZBE (E)
 BAB (D)
 BKS (D)

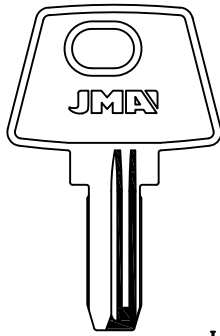

LAT.

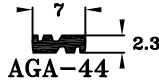

NEW
 AGA-50

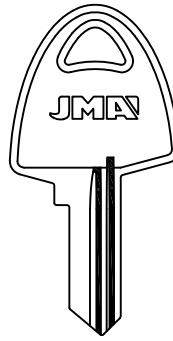

11I
 AGA-51

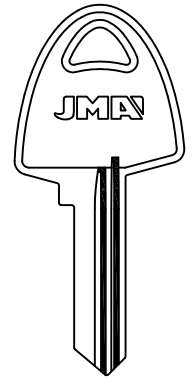

12I
 AGA-52

ASSA

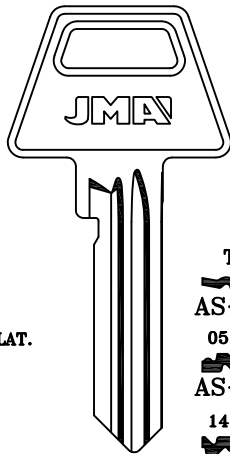

* LAT.

TL
 AS-4D
 05-04
 AS-5D
 14-01
 AS-6D
 05-13
 AS-7D

14-09
 AS-8D
 14-25
 AS-9D
 05-05
 AS-10D
 11-14
 AS-11D
 AS-12D

11-01
 AS-13D
 11-12
 AS-14D
 11-32
 AS-15D
 11-08
 AS-16D
 05-14
 AS-18D
 TM
 AS-25D
NEW
 * AS-28

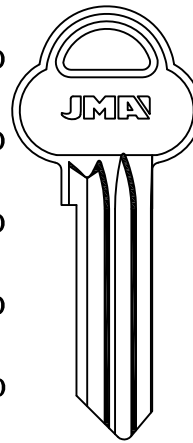

31 mm.

NEW
 560MG
 AS-MG5
 560KE
 AS-KE5
 560ME
 AS-ME5

AZBE

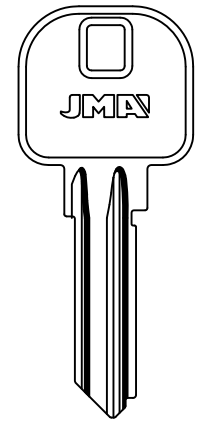

AZ-37 AZ-37D

BAB

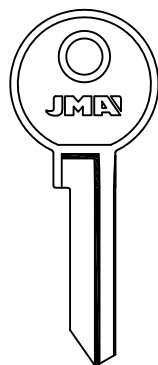

LAT.

BAB-17D

BKS

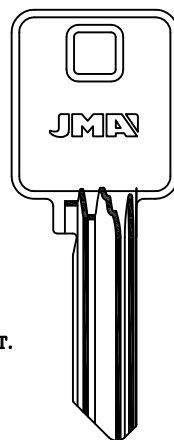

* LAT.

* BK-16/9 * BK-16/18
 * BK-16/7 * BK-16/17
 * BK-16/5 * BK-16/16 BK-16/30
 * BK-16/4 * BK-16/15 * BK-16/23
 * BK-16/3 * BK-16/14 * BK-16/21
 * BK-16/2 * BK-16/13 * BK-16/20
 * BK-16/1 * BK-16/10 * BK-16/19

SERIE 2000



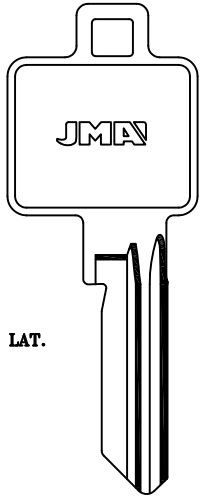

LAT.

BK-17/9PZ	BK-17D/7	
BK-17/8PZ	BK-17D/6	
BK-17/7PZ	BK-17D/5	
BK-17/6PZ	BK-17D/4PZ	BK-17D/4
BK-17/5PZ	BK-17D/3PZ	BK-17D/3
BK-17/2PZ	BK-17D/2PZ	BK-17D/2
BK-17/1PZ	BK-17D/1PZ	BK-17D/1
		BK-17D/9
		BK-17D/8

PZ-YALE

SERIE 0

BKS (D)

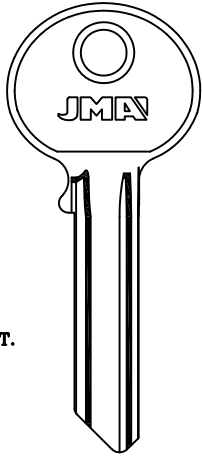

LAT.

BK-18/7	BK-18/16	BK-18/24	BK-18/31	
BK-18/6	BK-18/15	BK-18/23	BK-18/30	
BK-18/5	BK-18/14	BK-18/22	BK-18/29	
BK-18/4	BK-18/13	BK-18/21	BK-18/28	
BK-18/3	BK-18/11	BK-18/20	BK-18/27	BK-18/34
BK-18/2	BK-18/10	BK-18/18	BK-18/26	BK-18/33
BK-18/1	BK-18/9	BK-18/17	BK-18/25	BK-18/32

SERIE 1000

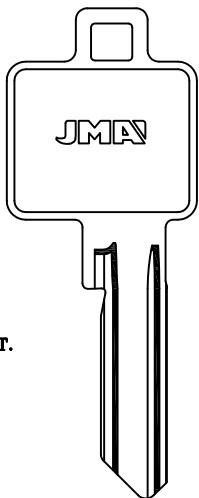

LAT.

BK-19/8	BK-19/19	BK-19/31	
BK-19/7	BK-19/16	BK-19/27	
BK-19/6	BK-19/15	BK-19/26	
BK-19/5	BK-19/13	BK-19/25	
BK-19/4	BK-19/12	BK-19/23	
BK-19/2	BK-19/11	BK-19/21	
BK-19/1	BK-19/10	BK-19/20	BK-19/32



PARA-FOR:

BKS

BKS (D)
 BMB (D)
 BSS (SCG)
 BTV (E)
 BURG (D)

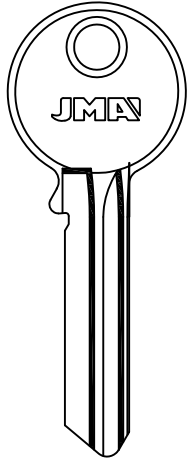

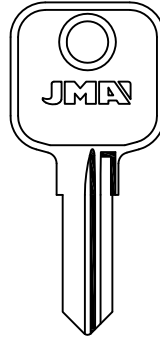

 BK-20

BMB

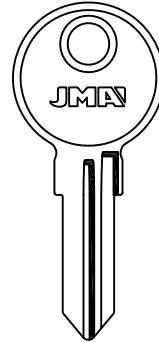

A
 BMB-1



A...401-600
 BMB-2

LAT.

BSS

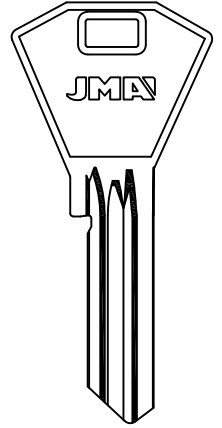

 BSS-5D
NEW
 BSS-7D

BANE SEKULIĆ-GE GE

BSS

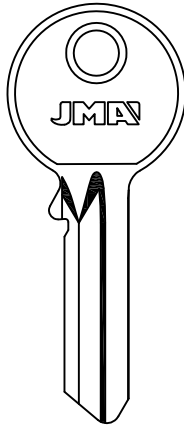

 BSS-6D

BANE SEKULIĆ

LAT.

BTV

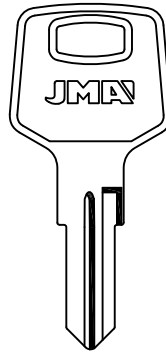

 BTV-3

BURG

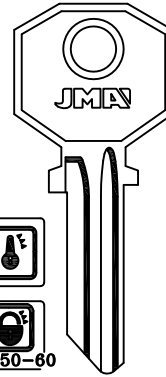

40-50-60
 1/91/9...
 0 AL 6
 BUR-1I BUR-1D
NEW
 *BUR-27D

*LAT.

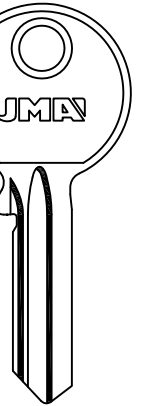

 BUR-26D

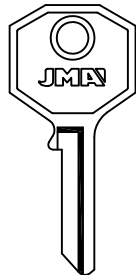

LAT.

BURG

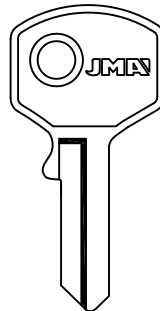

 BUR-28



 BUR-29  BUR-29D

LAT.

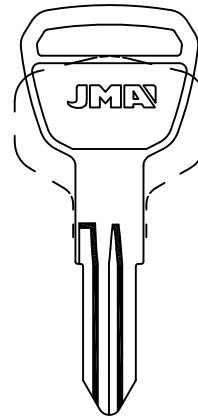

ZBK 70/74
 ZS 85/86

 BUR-31D

LAT.

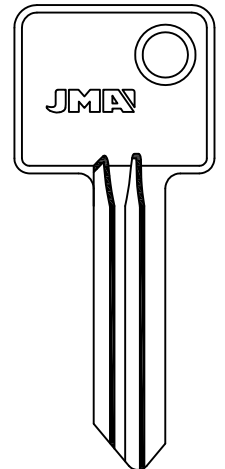

 BUR-32D

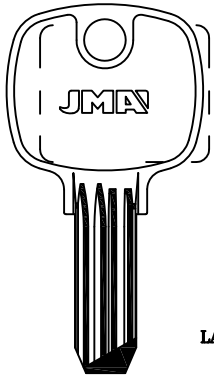

BURG

LAT.

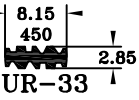

BUR-33

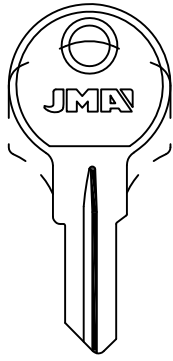
CAB

LAT.

CAB-1D

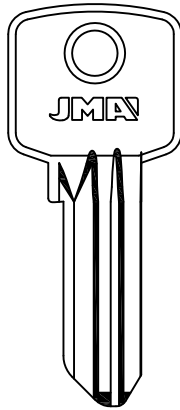
CAS-CISMA

LAT.

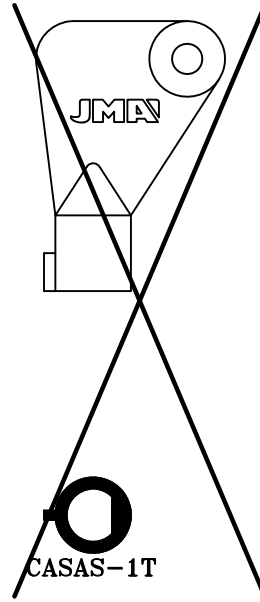
 KP2
 CIS-6D
 NEW
 CIS-7D
CASAS

CASAS-1T

PARA-FOR:

- BURG (D)
- CAB (I)
- CAS-CISMA (I)
- CES (D)
- CINA (RC)
- CISA (I)

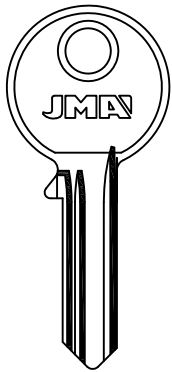
CES

LAT.

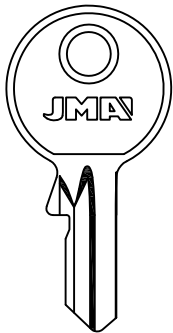
 WS 401-410
 CE-130

LAT.



CE-131D

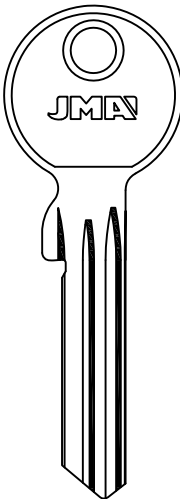

LAT.

- | | |
|-----------|-----------|
| 27 | |
| CE-132/27 | |
| 26 | 46 |
| CE-132/26 | CE-132/46 |
| 25 | 45 |
| CE-132/25 | CE-132/45 |
| 18 | 38 |
| CE-132/18 | CE-132/38 |
| 17 | 37 |
| CE-132/17 | CE-132/37 |
| 16 | 36 |
| CE-132/16 | CE-132/36 |
| 15 | 35 |
| CE-132/15 | CE-132/35 |

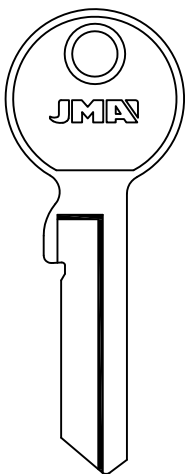
CES

CE-134

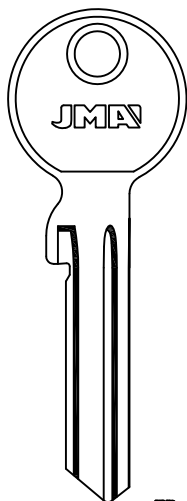

ALP.

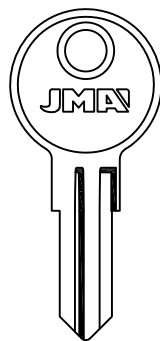
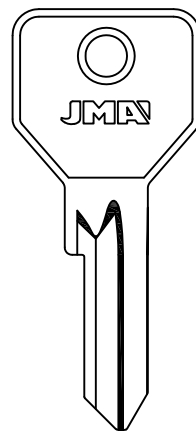
 TB
 CE-135D
CINA
 CIN-1
 CIN-1D
CISA

CI-62D



PARA-FOR: CISA

CISA (I)
CORBIN (I)
DIERRE (I)
DOM (D)

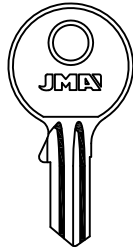

CI-65

ABUS-ALA

LAT.

ALU.
COL.
** FSH.
* LAT.
ABUS
ESCO
ESSENDIA
GEFI
GETE
GTV
NB
SCHUCO
STANDARD

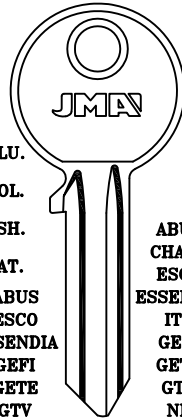

CI-IL

** CI-DL

	A		NEW
CI-2I	CI-2	CI-34	CI-34D
20	02		
CI-9D	CI-8D	CI-36	
04-05-07	08		
CI-11D	CI-10D	CI-38D	
33	11		
ESCO	CI-12	CI-42	
ESSENDIA			
ITO			
GEFI			
GETE			
GTV	CI-15D	CI-53	NEW
NB			* CI-66D
SCHUCO			NEW
STANDARD	CI-18	CI-16D	CI-64D
TREE			
	19		
	CI-29	CI-27	NEW
			CI-63
			NEW
			CI-63D

CORBIN

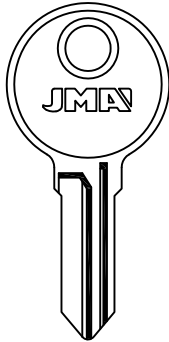

NEW
COR-24 COR-24D

CHANGE-O-MATIC

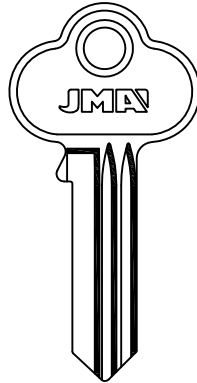

COR-62

LAT.

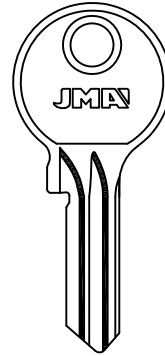

COR-115D

LAT.

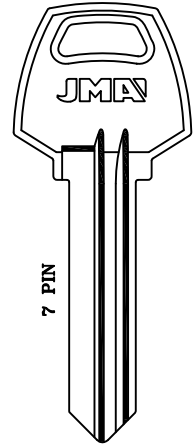

GRM
COR-153

7 PIN

BLACK & DECKER

DIERRE

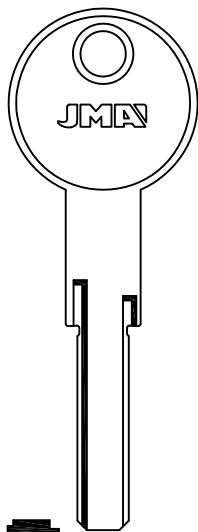

DR-1

ATRA

LAT.

DOM

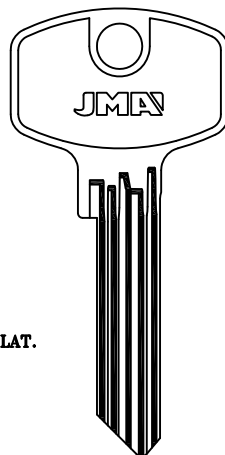

LAT.

DOM-27/35

DOM-27/19

DOM-27/16

DOM-27/13

DOM-27/12

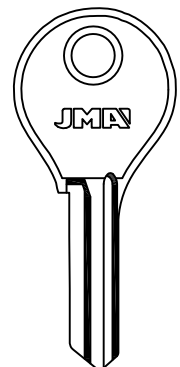

NEW
DOM-28 DOM-28D



DOM

PARA-FOR:

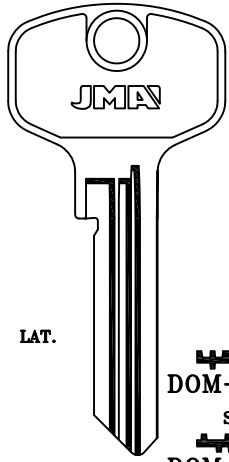

LAT.

DOM-58D

S

DOM-54D

C

DOM-53D

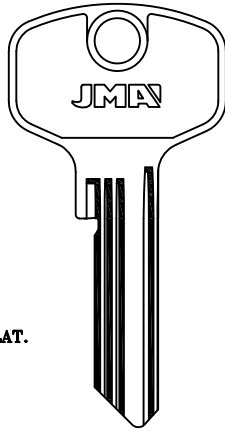

LAT.

DOM-65 DOM-67D

DOM-61 DOM-60D

DOM-59 DOM-57D

DOM-55 DOM-55D

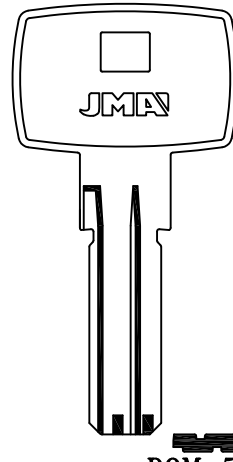

ALP.

DOM-56D

DOM-63D

DOM (D)
ESS (D)
EUROLOCKS (B)
EVVA (A)

DOM

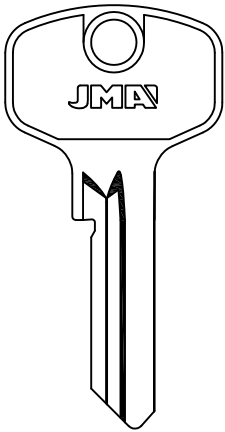

DOM-62D

STUV

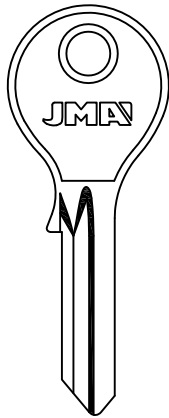

DOM-64D

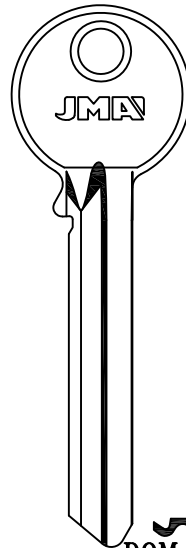

DOM-66D

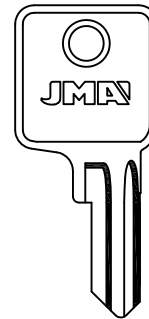

CL...1-250
GP...1-250
C...1001-1200
C...1301-1500

DOM-68

GEWIRU

ESS

EUROLOCKS

EVVA

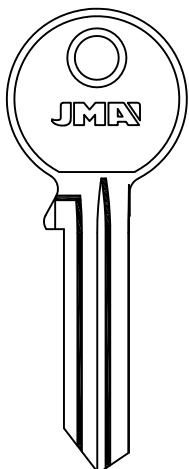

LAT.

ESS-9D

BAB

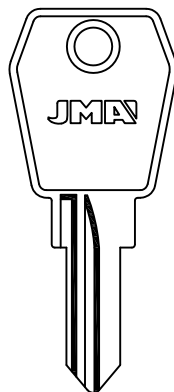

*ALU.

NEW
EU-13D

25001-27000

*EU-2

FASMA-L.&F.

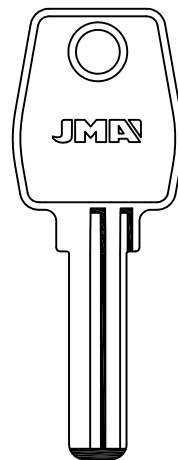

LAT.

7,6
2,9
EU-12

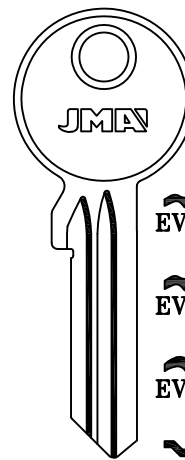

A
EV-6D

C
EV-7D

F
EV-8D

S
EV-9D

NEW
EV-23D

ELCA-TRYBA



PARA-FOR:

EVVA

EVVA (B)
 EXPRES (PL)
 FAC (E)
 FRIPA (D)
 FTH (F)
 GE GE (A)
 GERA (D)

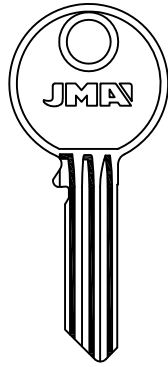

LAT.

NM...
 50000-54999

 EV-19

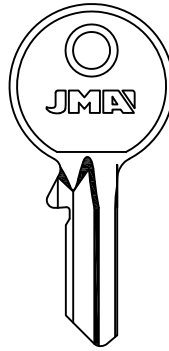

LAT.

...(K1) 4001-4250

 EV-20D

EXPRES

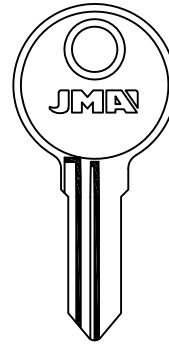

WTR

 EXS-3

RST

 EXS-2D

WT

 EXS-3D

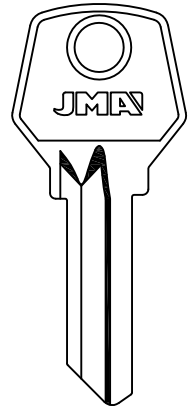

EXS-4D

SISO

EXPRES

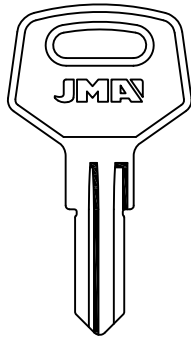

EXS-5

EXS-6

SISO

FAC

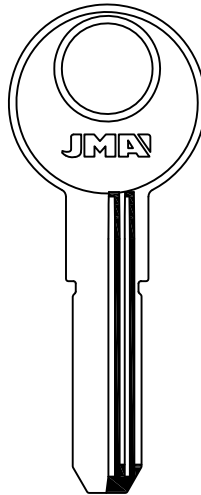

LAT.

8.9 2.35

 FAC-24

FRIPA

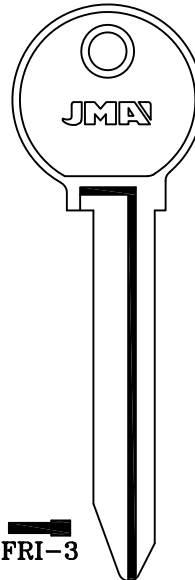

FRI-3

FTH

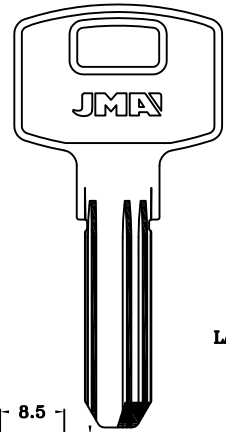

LAT.

8.5 2.35

 FTH-25

NEW

 FTH-30

THIRARD

FTH

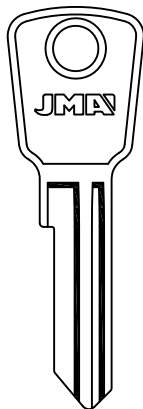

FTH-31

FEDERAL

GE GE

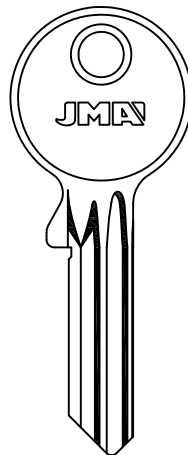

GE-21

GE-21D

GERA

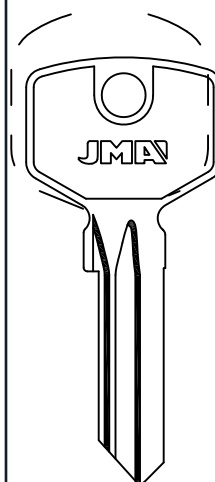

PZ6900

 GEA-6D

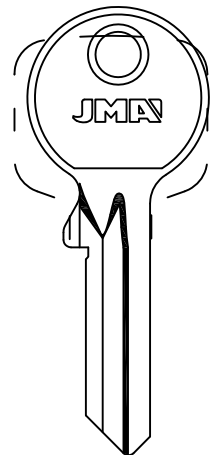

GEA-7D

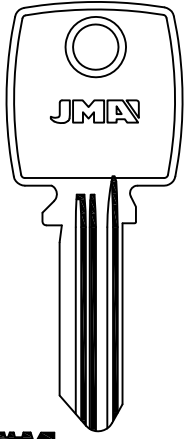

GTV

GTV-11

GTV-10

TIEFENTHAL

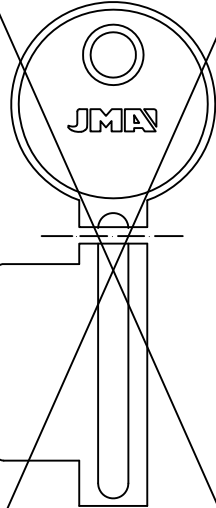
HECTOR

HEC-1

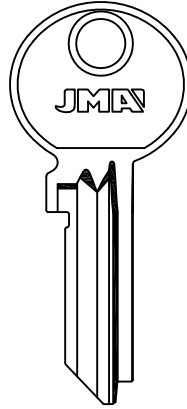
HTEC

HTE-1D

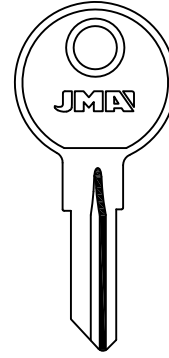
HUWIL

HUW-2

PARA-FOR:

GTV (D)
 HTEC (E)
 HUWIL (D)
 IKON (D)

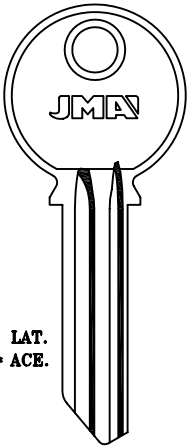
IKONLAT.
* ACE.

ZE-40D	ZE-41	ZE-78D	ZE-79	ZE-86D	ZE-93D	ZE-100	ZE-120
ZE-38	ZE-39	ZE-76D	ZE-77D	ZE-85	ZE-92D	ZE-99	ZE-119D
ZE-36D	ZE-37D	ZE-74	ZE-75	ZE-84	ZE-91D	ZE-98	ZE-118
ZE-21D	ZE-22	ZE-72	ZE-73	ZE-83	ZE-90	ZE-97D	ZE-104D
ZE-19	ZE-20	ZE-46	ZE-71D	ZE-82	ZE-89	ZE-96D	ZE-103
ZE-17D	ZE-18D	ZE-44D	ZE-45D	ZE-81	ZE-88	ZE-95D	ZE-102
* ZE-8	ZE-15	ZE-16D	ZE-42	ZE-43	ZE-80	ZE-87	ZE-94D

ZE-131 ZE-140

ZE-130 ZE-139D

ZE-129D ZE-138

ZE-128 ZE-137

ZE-124 ZE-135D

LAT.

ZE-123D ZE-134 ZE-144D

ZE-122D ZE-133D ZE-143

ZE-121D ZE-132D ZE-142

JMA[®]

Copyright by Alejandro Altuna S.A. 2012



ATENCIÓN: Concerniente a las marcas y denominaciones comerciales ver nota en índice.
 ATTENTION: Concerning the marks and commercial denominations see note in index.
 ATTENTION: Concernant les marques et dénominations commerciales voir la note dans l'index.
 ACHTUNG: Beziehen auf die Marke und Handelsname sehen sie die Notiz im Index.

PARA-FOR: IKON

IKON (D)
ILS (I)

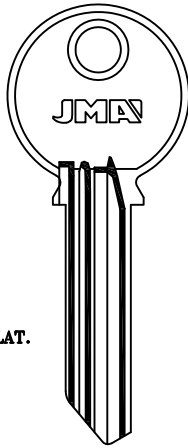

ZE-65D	ZE-66D	ZE-67D	ZE-68D	ZE-69D	ZE-110D	ZE-117D
ZE-60D	ZE-61D	ZE-62D	ZE-63D	ZE-64D	ZE-109D	ZE-116D
ZE-55D	ZE-56D	ZE-57D	ZE-58D	ZE-59D	ZE-108D	ZE-115D
ZE-50D	ZE-51D	ZE-52D	ZE-53D	ZE-54D	ZE-107D	ZE-114D
ZE-33D	ZE-34D	ZE-47D	ZE-48D	ZE-49D	ZE-106D	ZE-113D
ZE-28D	ZE-29D	ZE-30D	ZE-31D	ZE-32D	ZE-105D	ZE-112D
ZE-23D	ZE-24D	ZE-25D	ZE-26D	ZE-27D	ZE-70D	ZE-111D

ZE-147D

ZE-146D

ZE-145D

ZE-141D

ZE-136D

LAT.

ZE-127D

ZE-126D

ZE-125D ZE-148D

PERFIL Z SERIE 400

IKON

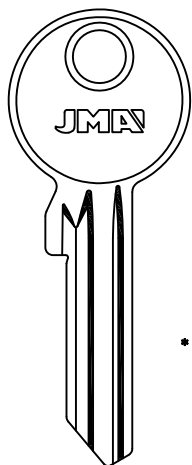

SN4 ZE-1	SN3 ZE-1D
SN2 ZE-2	SN1 ZE-2D
N2 ZE-6	N1 ZE-6D
	M ZE-9D
NEW SN5 * ZE-14D	

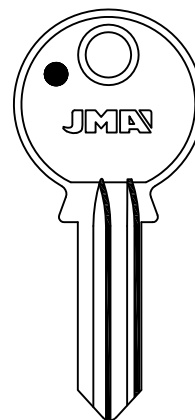

DS1
 ZE-35

DS2
 ZE-35D

BRUMME-OTIS

ILS

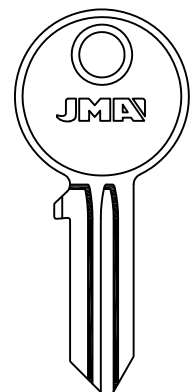

ILS-1



ISEO

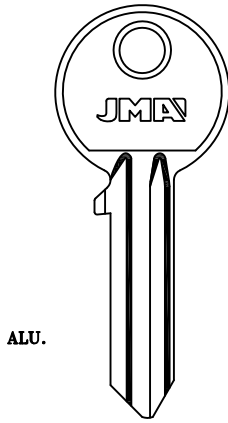

ALU.



....1-2000
Y....1-2000
0 AL 8



JARDI

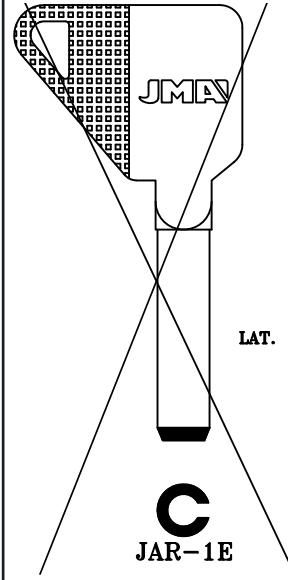

LAT.



PARA-FOR:

- ISEO (I)
- JOWIL (D)
- JPM (F)
- KESO (CH)
- KFV (D)
- LINCE (E)
- LITTO (B)

JOWIL

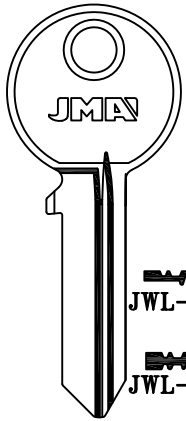

GTV

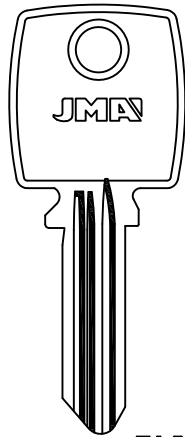

LAT.



JPM

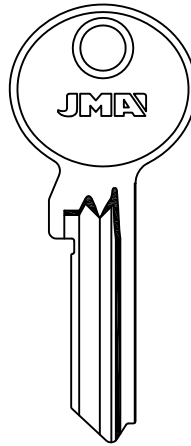

KESO

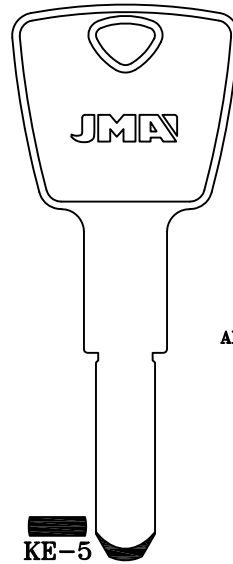

ALP.



KFV

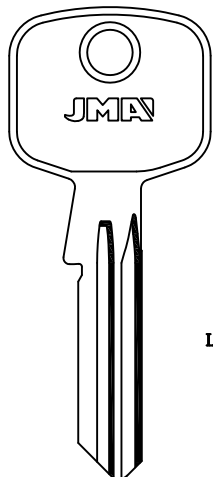

LAT.



COMBA-FCV-FLIETHER-GIESCHE
GOTZ-GRAF-HSA-NICO-SCHUCCO-SEN

LINCE

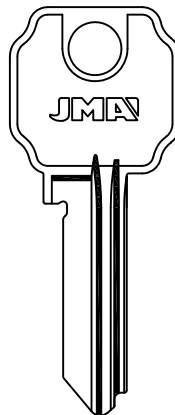

LITTO

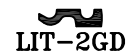
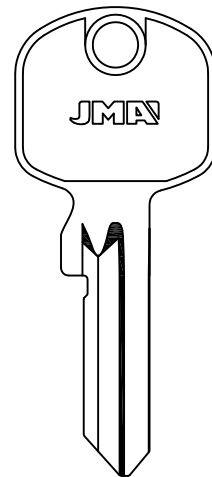

PARA-FOR:

L&F

L&F (GB)
 LT (PRC)
 MAGNUM
 MCM (E)
 MLM (F)
 MUL.T.LOCK (IL)
 RUKO (DK)
 SERRALLER (E)

.....35000-35499
78000-78999
79000-79999



LF-21

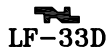

LF-33D



NEW
 LF-43

LT

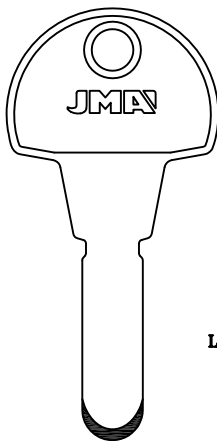

LAT.

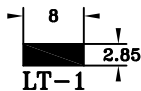

LT-1

MAGNUM

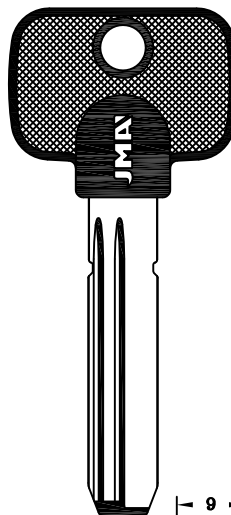

ALP.

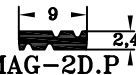

MAG-2D.P1

MCM

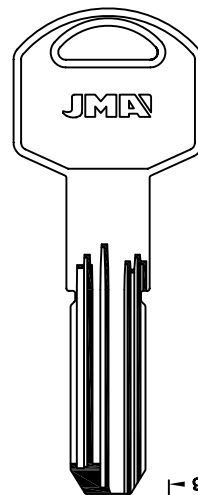

LAT.

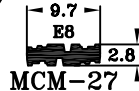

MCM-27

MLM

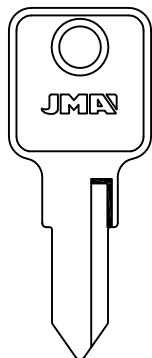

MLM-2

NEW
 MLM-5 MLM-5D

DOM-STUV

MUL.T.LOCK

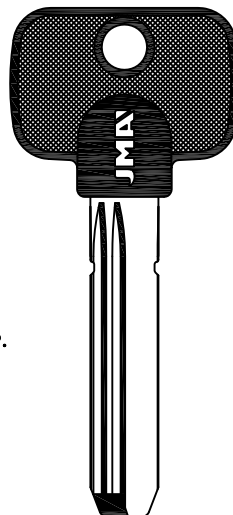

ALP.

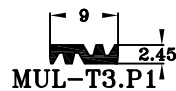

MUL-T3.P1

64
NEW
 MUL-T8.P1

NEW
 MUL-T9.P1

JUNIOR
NEW
 MUL-T11.P1

GAMMA

RUKO

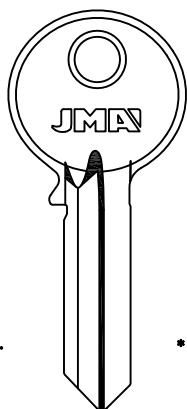

ALU.

* LAT.

.....1 AL 8
1 AL 9
1 AL 9 AL 0 A-B
0 AL 9 A AL M
 S.....1 AL 9



RU-1D

DIFA



RU-2I



RU-2D



RU-3D



RU-4D



RU-10D



NEW
 * RU-19D



RU-TL

SERRALLER

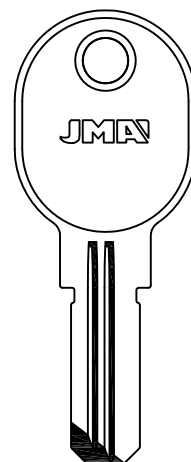

LAT.



SER-3D



STEM

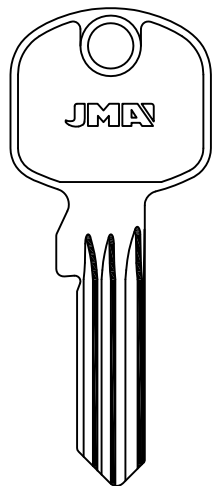

 STE-8D

 STE-7

 STE-6

 STE-5D

 STE-4

 STE-3

 STE-1

 STE-2D

NEW
 STE-14D

NEW
 STE-13D

 STE-12

 STE-11

 STE-10

 STE-9D

GE GE

STUV

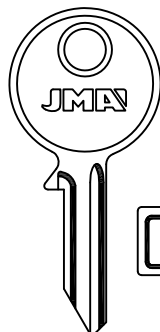

1F...201-278

1F...Z201-278

1F...X201-278

2F...

201-278

 STUV-1I  STUV-1D

9F

NEW
 STUV-3

DOM-MLM

TECON

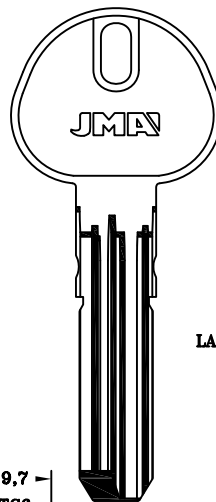

LAT.

9,7
TC6
2,8
TC-1

PARA-FOR:

STEM (D)
STUV (D)
TECON (E)
TITAN (SLO)
TOK WINKHAUS (D)

TITAN

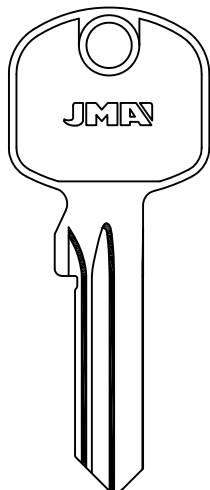

 TIT-2GD

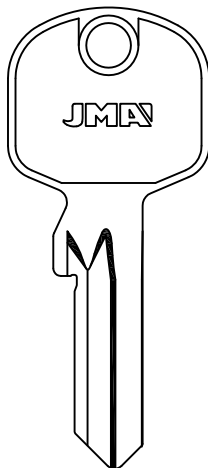

 TIT-8GD

TOK WINKHAUS

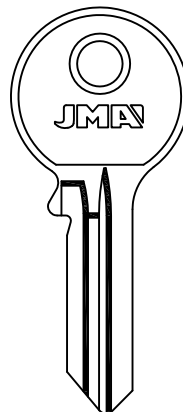

LAT.

 TOK-56D

TRELOCK

TOK WINKHAUS

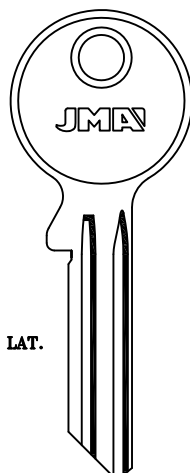

LAT.

 TOK-75

 TOK-61

 TOK-60

 TOK-59

 TOK-58

 TOK-78

 TOK-77

SERIE AZ 01 N

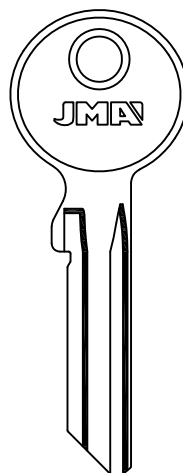

LAT.

 TOK-76

JMA[®]

Copyright by Alejandro Altuna S.A. 2012



ATENCIÓN: Concerniente a las marcas y denominaciones comerciales ver nota en índice.
ATTENTION: Concerning the marks and commercial denominations see note in index.
ATTENTION: Concernant les marques et dénominations commerciales voir la note dans l'index.
ACHTUNG: Beziehen auf die Marke und Handelsname sehen sie die Notiz im Index.

PARA-FOR: TOK WINKHAUS

TOK WINKHAUS
(D)
TRELOCK (D)
TSAG (E)
UNIVERSAL

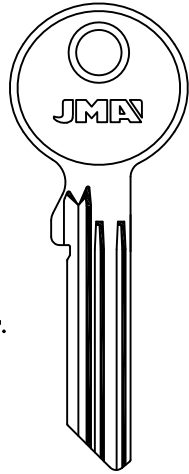

LAT.

- | | | | | | | | |
|-------------------------|--------------------------|--------------------------|--------------------------|--------------------------|---------------------------|--------------------------|--------------------------|
| NEW X7
TOK-37 | NEW X6
TOK-62 | NEW X6
TOK-62D | NEW X14
TOK-40 | X13
TOK-8 | X12
TOK-39 | X11
TOK-38 | X18
NEW TOK-69 |
| NEW X5
TOK-47 | NEW X5
TOK-47D | NEW X4
TOK-21 | NEW X4
TOK-21D | NEW X10
TOK-48 | NEW X10
TOK-48D | NEW X17
TOK-68 | NEW X16
TOK-41 |
| NEW X3
TOK-46 | NEW X2
TOK-45 | NEW X2
TOK-45D | NEW X9
TOK-67 | NEW X8
TOK-63 | NEW X15
TOK-49 | | |
| NEW X1
TOK-44 | NEW X1
TOK-44D | | | | | | |

SERIE X

TOK WINKHAUS

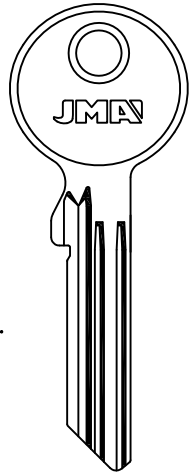

LAT.

- | | | | | | | | | | | | | | | | | | |
|-------------------------|-------------------------|-------------------------|-------------------------|-------------------------|-------------------------|-------------------------|---------------|--------------------------|--------------------------|--------------------------|--------------------------|-------------------------|-------------------------|--------------------------|--------------------------|--------------------------|--------------------------|
| NEW Y7
TOK-52 | NEW Y6
TOK-43 | NEW Y5
TOK-51 | NEW Y4
TOK-70 | NEW Y3
TOK-22 | NEW Y2
TOK-42 | NEW Y1
TOK-50 | Y14
TOK-24 | Y13
NEW TOK-72 | Y12
NEW TOK-66 | Y11
NEW TOK-64 | Y10
NEW TOK-54 | Y9
NEW TOK-53 | Y8
NEW TOK-71 | Y18
NEW TOK-74 | Y17
NEW TOK-65 | Y16
NEW TOK-55 | Y15
NEW TOK-73 |
|-------------------------|-------------------------|-------------------------|-------------------------|-------------------------|-------------------------|-------------------------|---------------|--------------------------|--------------------------|--------------------------|--------------------------|-------------------------|-------------------------|--------------------------|--------------------------|--------------------------|--------------------------|

SERIE Y

TRELOCK

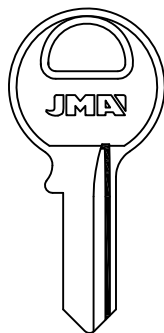

TRL-2
HAMPTON

TSAG

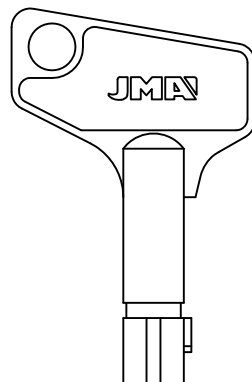

J
SAG-1T
NEW DESIGN
NUEVO DISEÑO

UNIVERSAL

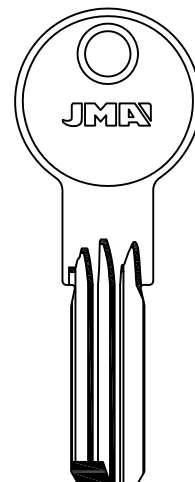

LAT.

TX-2
ISEO

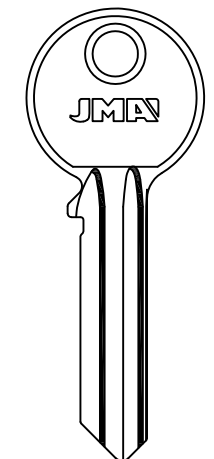

U-26 U-26D



VIRO

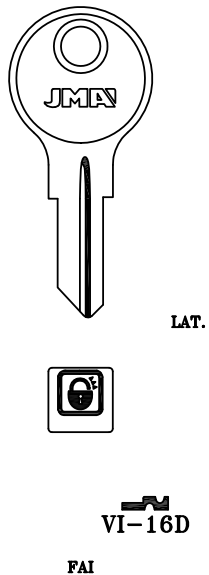
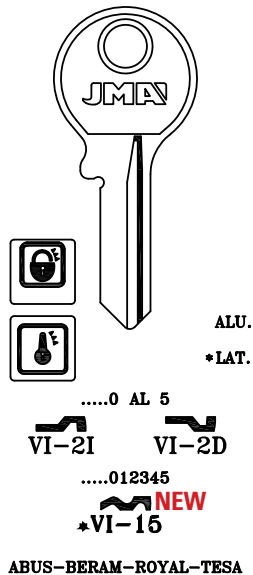

WELKA

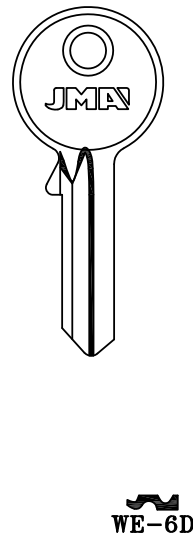

PARA-FOR:

VIRO (I)
WELKA (I)
WILKA (D)
WINLOCK (GB)
YALE (D-GB-USA)

WILKA

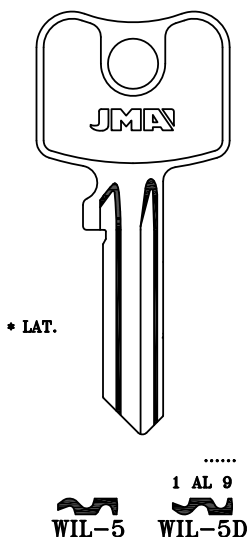

* WIL-26	* WIL-33D	* WIL-40D	* WIL-48D	* WIL-55	NEW	
* WIL-25	* WIL-32	* WIL-39D	* WIL-47D	* WIL-54		
W101						
WIL-24	* WIL-31D	* WIL-38D	* WIL-46D	* WIL-53		
WIL-19D	* WIL-30	* WIL-37D	* WIL-45D	* WIL-52		
WIL-18	* WIL-29	* WIL-36D	* WIL-44	WIL-51D		
* WIL-9	* WIL-28	* WIL-35D	* WIL-43D	* WIL-50D		* WIL-57D
WIL-8	* WIL-27	* WIL-34D	* WIL-41D	* WIL-49D		* WIL-56

WINLOCK

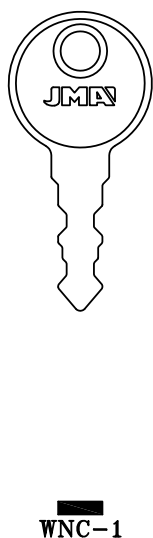

YALE

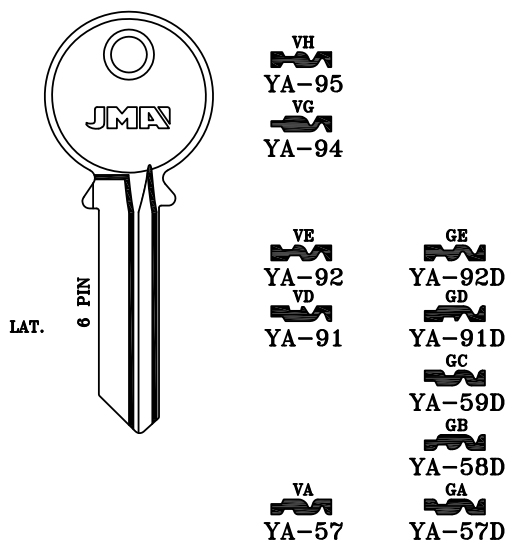

PARA-FOR: YALE

YALE
(D-GB-USA)

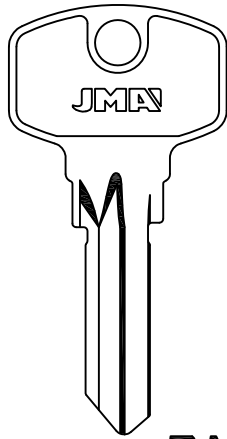

YA-79D
NEW
YA-272D

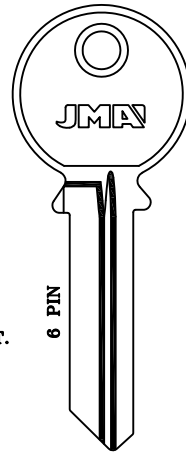

LAT.

6 PIN

LG
YA-103D
LF
YA-102D
LE
YA-101D
LD
YA-100D
LC
YA-99D
LB
YA-98D
LA
YA-97D

YALE

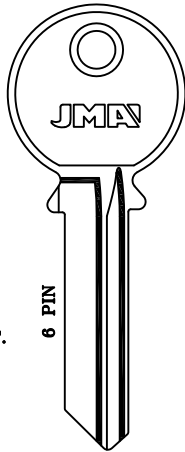

LAT.

6 PIN

YG
YA-113
YF
YA-112
YE
YA-111
YB
YA-108

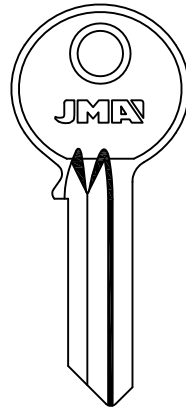

LAT.

YA-142D

BKS

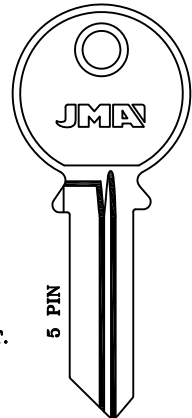

LAT.

5 PIN

GA
YA-186D

YALE

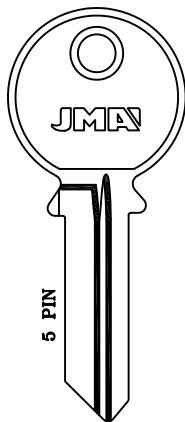

LAT.

5 PIN

LG
YA-212D
LE
YA-210D
LD
YA-209D
LC
YA-208D
LA
YA-206D

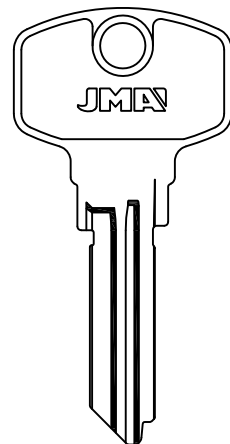

KTM
YA-273D



YALE (D-GB-USA)
 YARDENI (IL)
 YUN HUAN (PRC)
 YWS (TW)

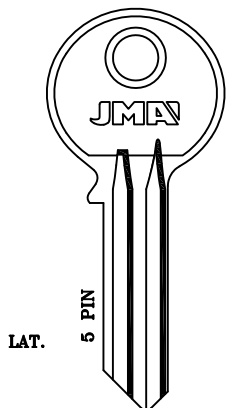

- VF
YA-221
- VE
YA-220
- VD
YA-219
- VB
YA-217
- VA
YA-216

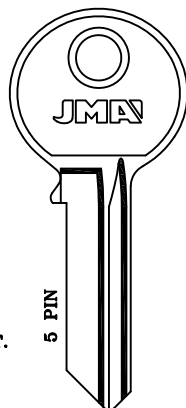

- YH
YA-232
- YE
YA-229
- YD
YA-228
- YC
YA-227
- YB
YA-226
- YA
YA-225

BKS

BKS

YADERNI

YUN HUAN

YWS

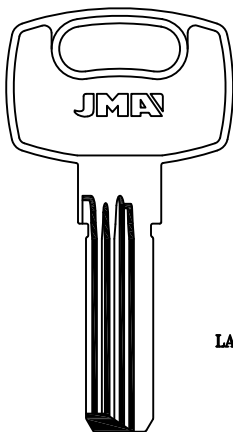

YAR-3

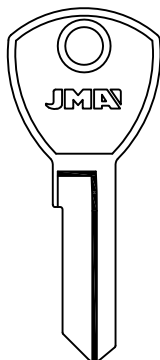

YUH-1D

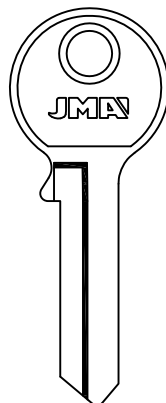

YUH-2D

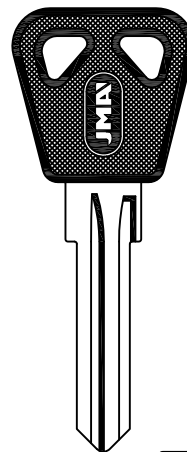

YW-1.P

ABUS



LLAVES PARA VEHÍCULOS

IBILGAILUENTZAKO GILTZAK

KEYS FOR VEHICLES

CLÉS POUR VÉHICULES

FAHRZAUGESCHLÜSSEL



THE KEY TO EXCELLENCE

GLOBALLY UNLOCKING MILLIONS OF DOORS DAILY

PARA-FOR:

B&S

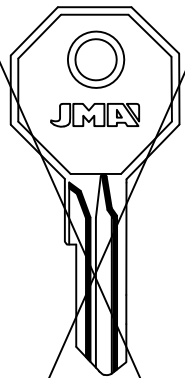

BS-3D

BOSCH

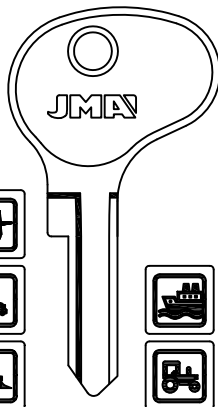

MS-S
1-50
BH-8

KOLB-LAPORTE

BURG

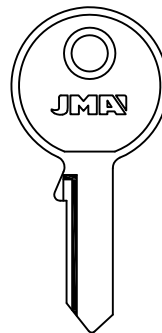

BUR-30D

MOFA

DAEWOO

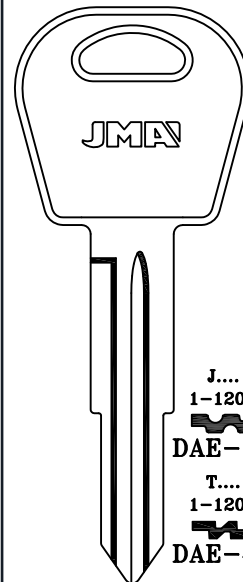

J...
1-1200
DAE-3D
T...
1-1200
DAE-4D

- BOSCH (D)
- BURG (D)
- DAEWOO (K)
- FLORA (D)
- GEWU
- GHE (D)
- HARLEY DAV.
(USA)
- HONDA (J)
- HUF (D)

FLORA

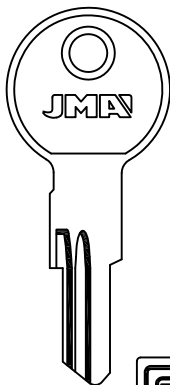

903-979
1-9 00-80
FLO-2D

RUNO

GEWU

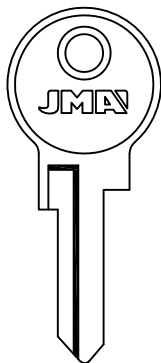

GW-1D

ZUNDAPP

GHE

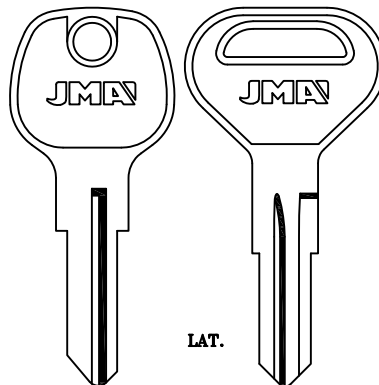

LAT.



GY
25-90
GH-2

LS 378-816

GH-3

PEROHAUS-POS-WECO

KASSBOHRER

HARLEY DAV.

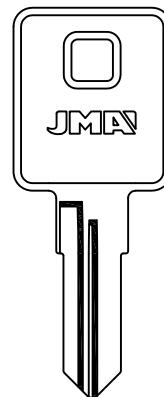

HD-4D

HONDA

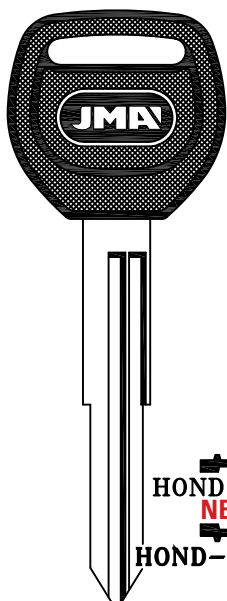

HOND-24.P
NEW
HOND-24D.P

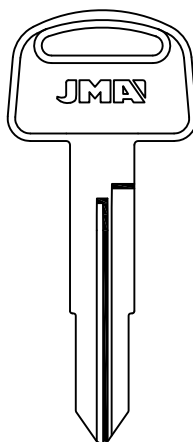

A..00-99
HOND-43 HOND-43D

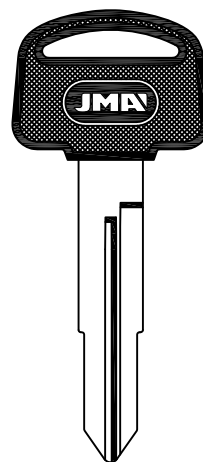

A..00-99
HOND-43.P HOND-43D.P

HUF

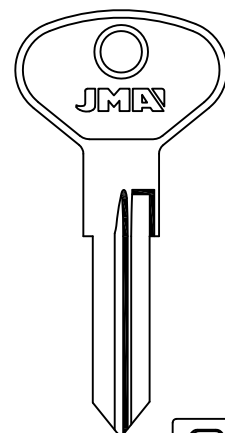

NW...
1-51
HU-NW

BOSCH

JMA®

Copyright by Alejandro Altuna S.A. 2012

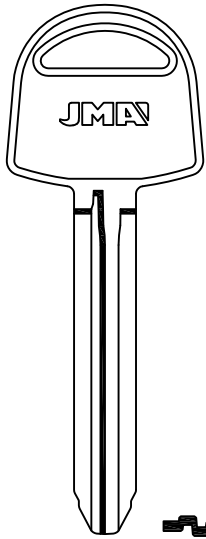

ATENCIÓN: Concerniente a las marcas y denominaciones comerciales ver nota en índice.
ATTENTION: Concerning the marks and commercial denominations see note in index.
ATTENTION: Concernant les marques et denominations commerciales voir la note dans l'index.
ACHTUNG: Beziehen auf die marke und handelsname sehen sie die notiz im index.

ISUZU

ISU-3D

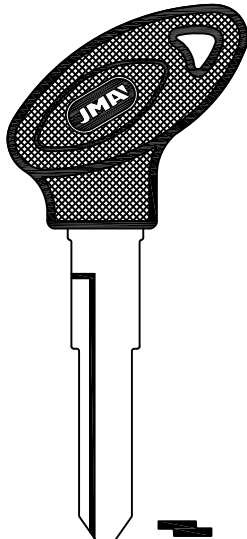
MONDIAL

MOD-1D.P

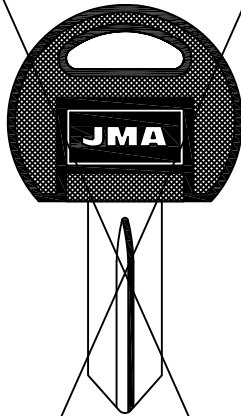
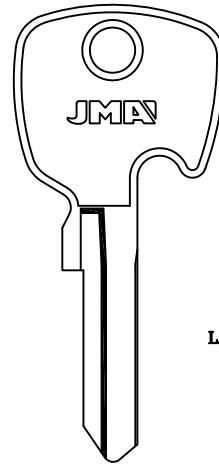
NEIMANNE-21.P
VOLVO
FASTEXD...
1-2-3-4-5
NE-61D**PARA-FOR:**

ISUZU (J)
MONDIAL (F)
NEIMAN (F)
TOYOTA (J)
TRW-SIPEA (I)
YWS (TW)
ZADI (I)

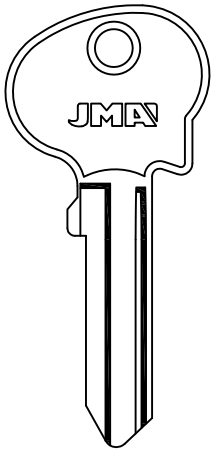
NEIMAN

LAT.

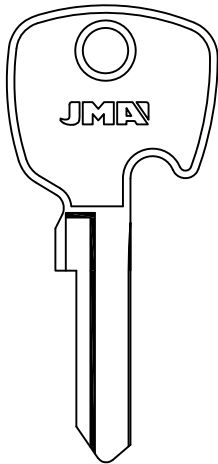
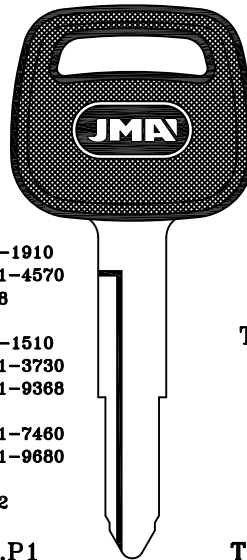
B...
1-2-3-4-5
NE-62M...
1-2-3-4-5
NE-63D**TOYOTA**

K...
001-400/1511-1910
2221-2620/3731-4570
5001-6368
R...
401-800/1112-1510
2621-3020/3331-3730
5001-6924/8001-9368
S...
5951-6350/7061-7460
8171-8570/9281-9680
D...
6001-7042
TOYO-12.P1

F...
5951-6350
7061-7460
8171-8570
9281-9680
P...
7001-8500
TOYO-13.P1

C...
6001-8042
U...
3001-4000
Z...
1-1000
TOYO-12D.P1

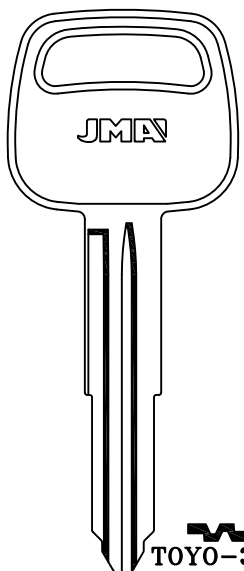
TOYOTA
TOKAJ-RIKA**TOYOTA**

TOYO-37D

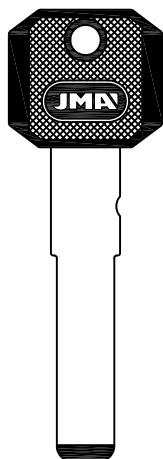
TRW-SIPEA

LAT.

FI-16.P1

GIOBERT

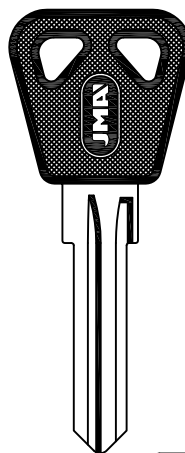
YWS

YW-1.P

ABUS

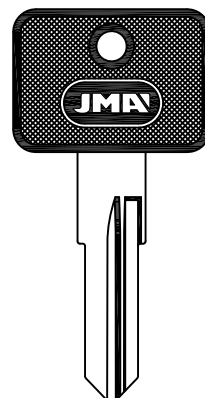
ZADI

ZA-5.P







NEW
ZA-5D.P**JMA**

Copyright by Alejandro Altuna S.A. 2012



ATENCIÓN: Concerniente a las marcas y denominaciones comerciales ver nota en índice.
ATTENTION: Concerning the marks and commercial denominations see note in index.
ATTENTION: Concernant les marques et dénominations commerciales voir la note dans l'index.
ACHTUNG: Beziehen auf die marke und handelsname sehen sie die notiz im index.

MOTOCICLETA- MOTORCYCLE

MARCA Brand	MODELO Model						
BMW	RT 850 RT	1996-2002	BM-HBP1	BM-HBP1	BM-HBP1	BM-HBP1	BM-HBP1

LLAVES DE CRUZ-GORJA-ARMARIO
GURUTZE-GORJA-ARMAIRUETARAKO GILTZA
CRUCIFORM-BIT -FURNITURE KEYS
CLÉS CRUCIFORMES-GORGES- POUR MEUBLES
KREUTZSCHLÜSSEL-CHUBBSCHLÜSSEL-MOBELSCHÜSSEL

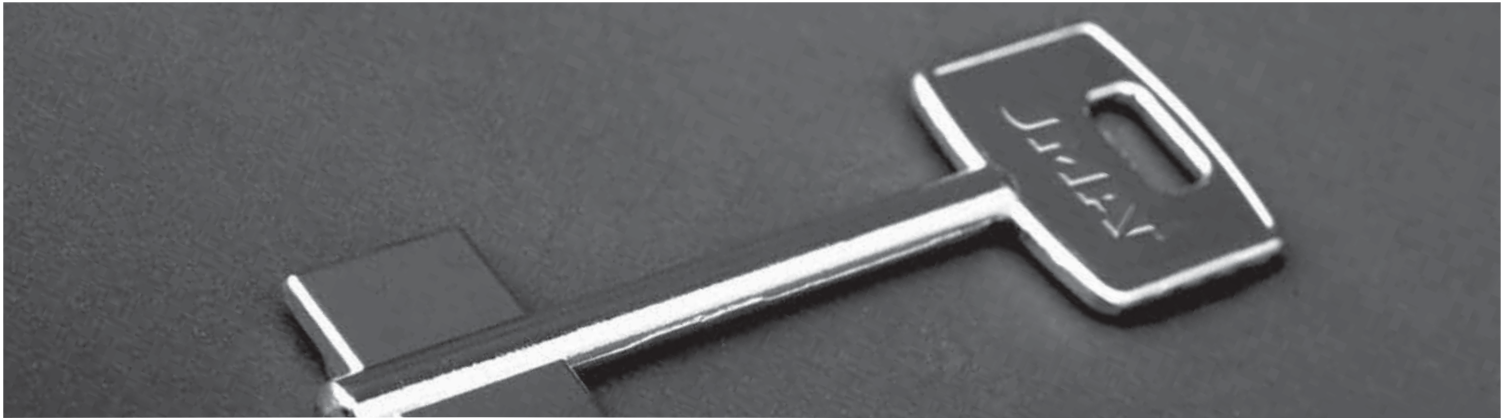

THE KEY TO EXCELLENCE
GLOBALLY UNLOCKING MILLIONS OF DOORS DAILY

PARA-FOR:

BLUMA

BLUMA (D)
MP
CISA (I)
CR (I)
CRONOS

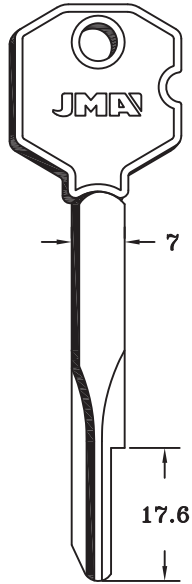

+

BLU-2X

BOINAITI

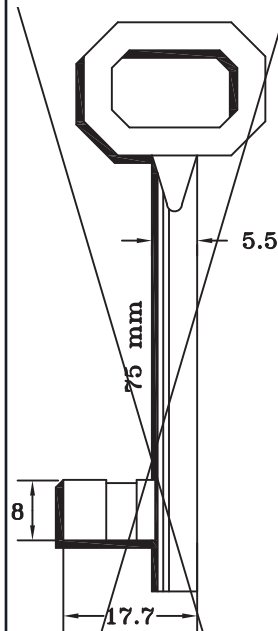

BON-2G

MP

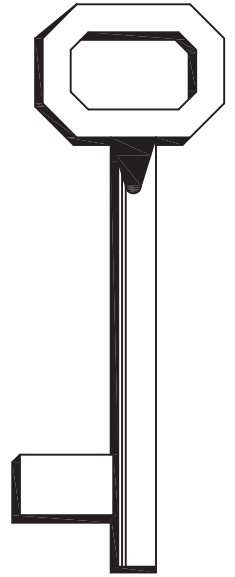

MPA-1G

CISA

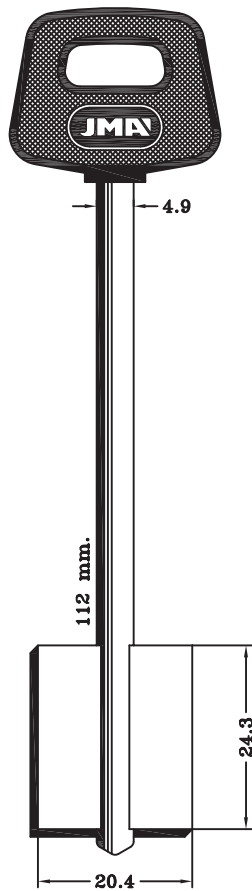

CI-3PG

CR

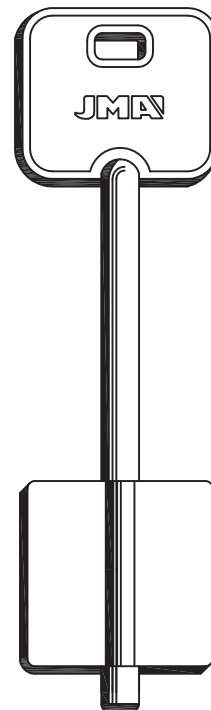

CR-19G

CRONOS

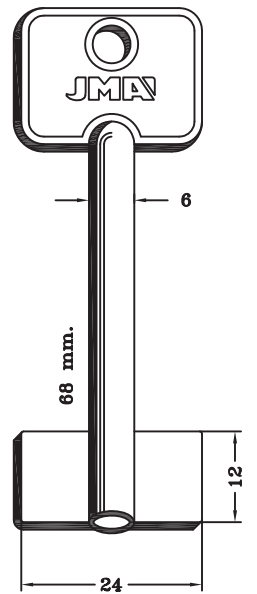

+

4

CRO-1G



MOTTURA

PARA-FOR:

MOTTURA (I)

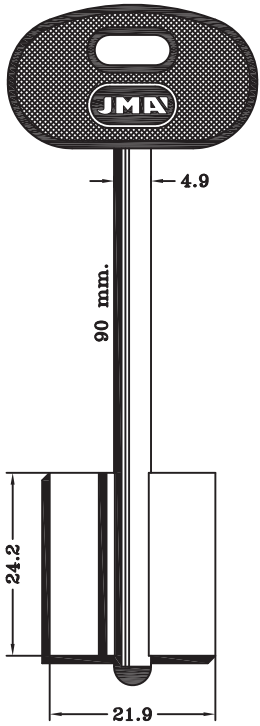

MT-3P1G

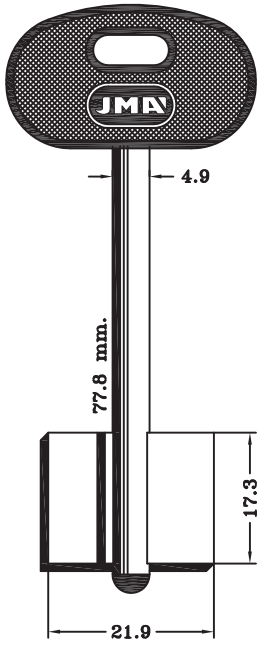

MT-5P1G

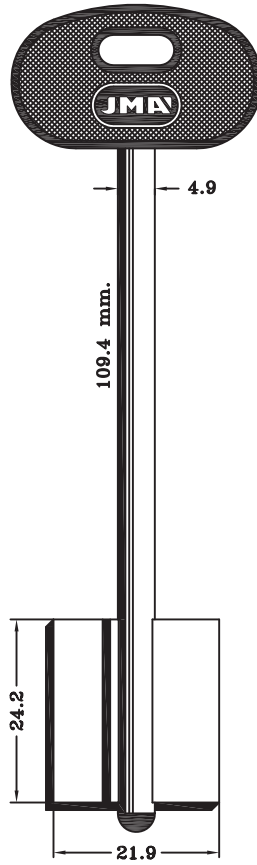

MT-10P1G
MT-6P1G

MOTTURA

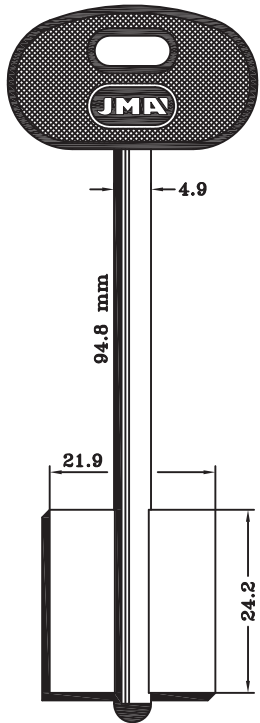

MT-9P1G

MT-8P1G

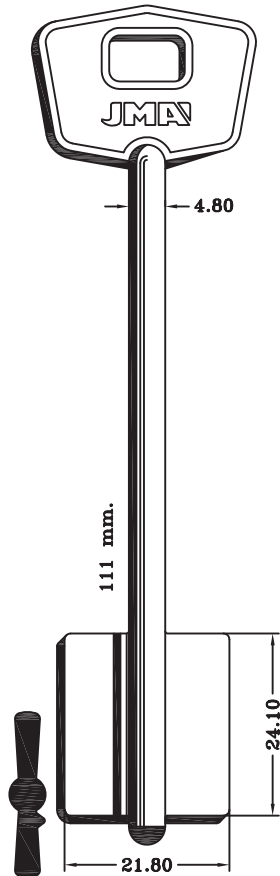

MT-18G



PARA-FOR:

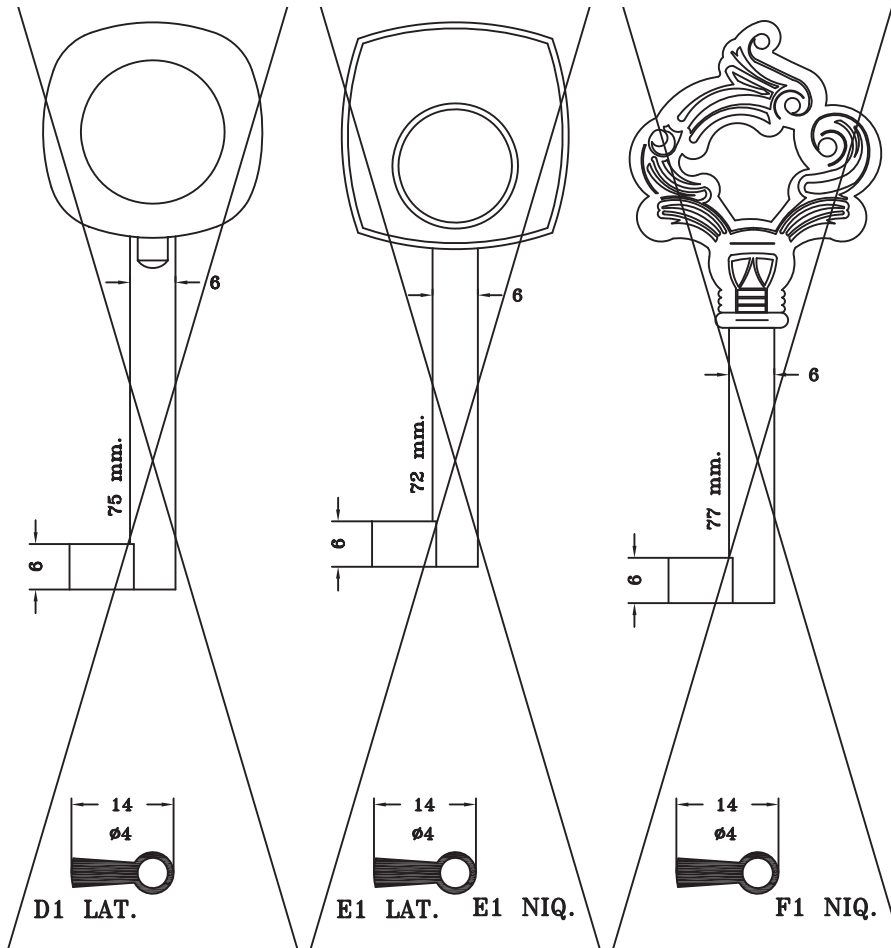

ESPECIALISTA
SPECIALIST

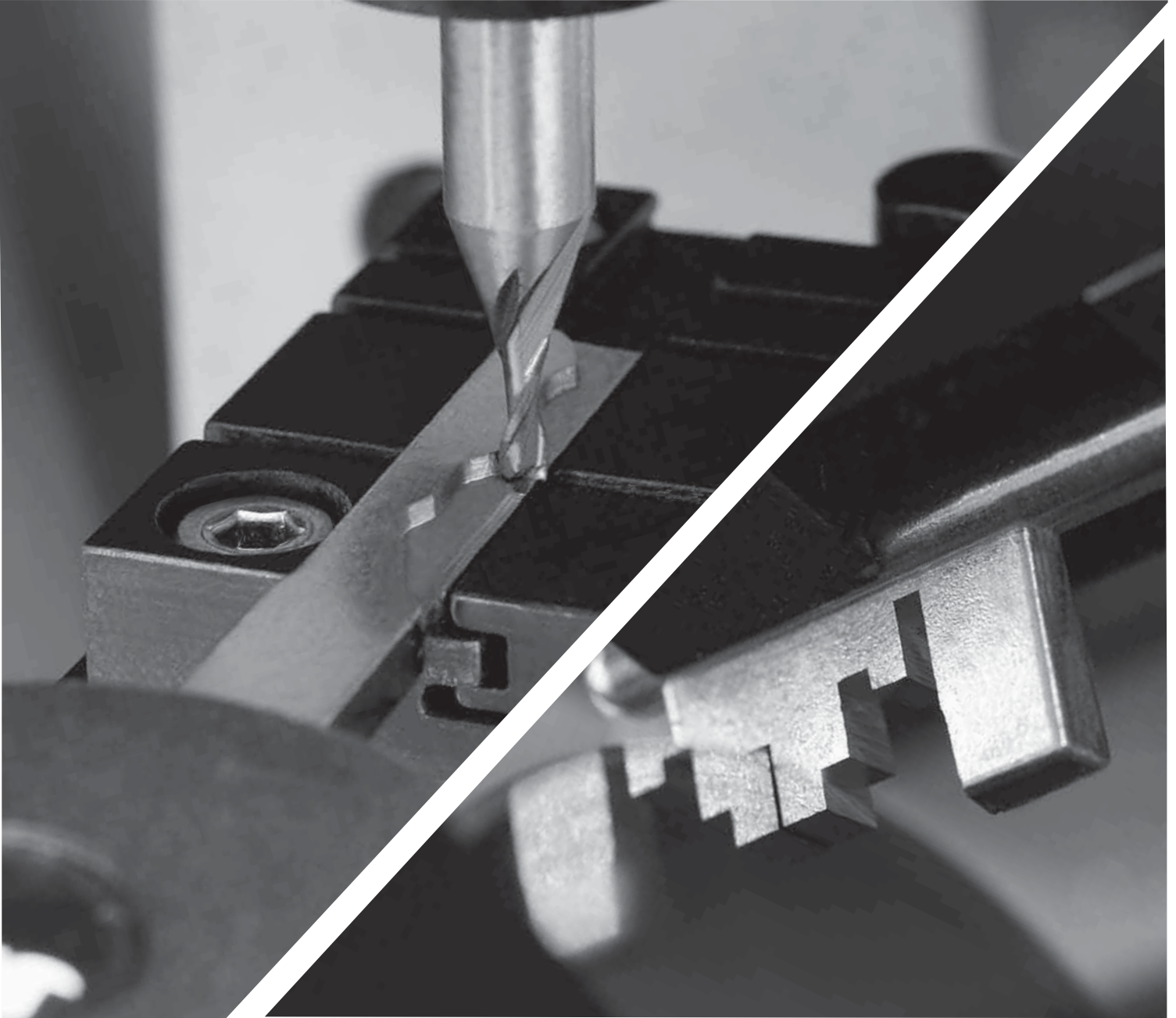

SUPLEMENTO-SUPPLEMENT 2011.C10

THE KEY TO EXCELLENCE
GLOBALLY UNLOCKING MILLIONS OF DOORS DAILY

FRESAS

FRESAK
MILING CUTTERS
FRAISES
FRÄSE

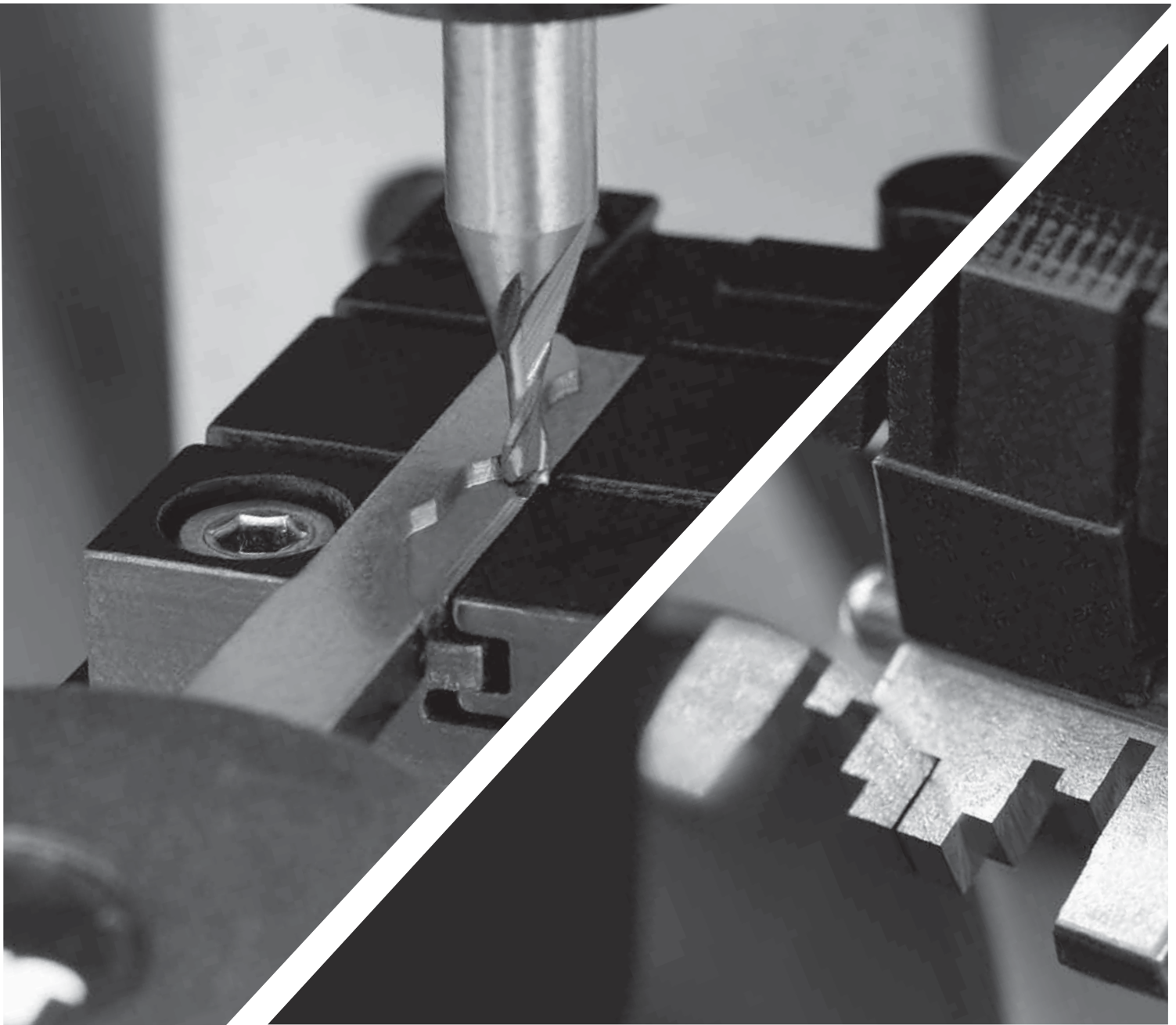

THE KEY TO EXCELLENCE
GLOBALLY UNLOCKING MILLIONS OF DOORS DAILY

CEPILLOS

ESKUILA-BRUSH-BROSSES-BÜRSTE

CODE	AxB	PARA-FOR
C1	60x10	BOSTON
C2	75x10	CE-2
C3	80x13	DAKOTA-DAKOTA-EXTRA-
C4	80x10	DAKOTA ANTIGUA-NEVADA-KANSAS-DENVER
C5	100x13	SARATOGA-YAKARTA
C6	65x13	ECCO-PLUS, ECCO-BIT
C7	75x13 (Nylon)	PROCEDURE - SENNA - VIENNA

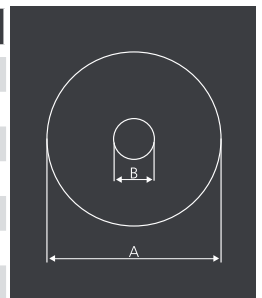

FRESAS

FRESAK-MILING CUTTERS-FRAISES- FRÄSE

CODE	AxB		PARA-FOR	MAT.
FP7	63x1,25x16	lateral	ECCO BIT-DETROIT	HSS
FP8	63x1,4x16	lateral	ECCO BIT-DETROIT	HSS
FP9	63x1x16		ECCO BIT	HSS
FP10	63x2,4x16		ECCO FORD-ECCO ABLOY-PASADENA-NEBRASCA	HSS
FP17	80x1,25x16	lateral	SARATOGA-YAKARTA-TITAN-BIT	HSS
FP18	80x1,25x22	lateral	ATLANTA-TOPEKA	HSS
FP19	80x1,4x16	lateral	SARATOGA-YAKARTA-TITAN-BIT-DAKOTA G	HSS
FP20	80x1,4x22	lateral	ATLANTA-TOPEKA	HSS
FP21	80x1,5x22	lateral	DUPLEX-ATLANTA-TOPEKA-KANSAS	HSS
FP21W	80x1,5x22	lateral	DUPLEX-ATLANTA-TOPEKA-KANSAS	W
FP22	80x1x16		SARATOGA-DAKOTA G-TITAN BIT	HSS
FP23	80x1x22		DUPLEX-ATLANTA-TOPEKA	HSS
FP26	80x1,5x16		SARATOGA-YAKARTA-DAKOTA-G-SENNA	HSS
FP26W	80x1,5x16		SARATOGA-YAKARTA-DAKOTA-G-SENNA	W
FP27W	70x2,4x16			W
FP28W	70x1,7x16			W
FP31	80x1,6x16		SARATOGA-DAKOTA G-TITAN BIT	HSS

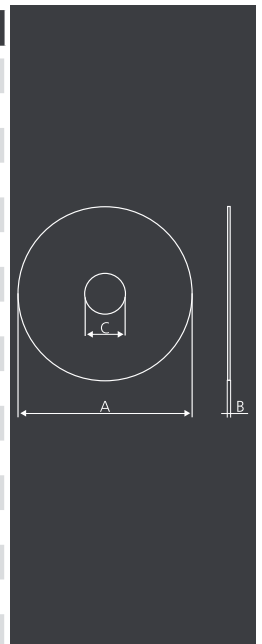

CODE	AxBxC	D	E	PARA-FOR	MAT.
FP1	25x10x10	50	0	OREGON	HSS
FP2W	40x6x10	35	0,1	VIRGINIA	W
FP3	50x6x12	45	0,15	KIS	HSS
FP4	53x6,3x12	45	0,1	KIS	HSS
FP5	57x5x12,7	45	0,15	JMA	HSS
FP6	60x5x12,7	42	0,1	SPRINT	HSS
FP11	63x5x16	42	0,15	ECCO-ECCO PLUS-ECCO AUTOMATIC	HSS
FP12	63x5x16	40	0,1	TUCSON	HSS
FP13	63x5x16-150D	42	0,1	DALLAS	HSS
FP14	70x13x7	45	0	LINCE CE-2	HSS
FP15	70x13x7-110	55	0	LINCE CM-1	HSS
FP16	70x5,25x16	40	0,1	PROCEDURE	HSS
FP16W	70x5,25x16	40	0,1	PROCEDURE	W
FP24	80x5x16	42	0,15	DAKOTA EXTRA-SARATOGA-NEVADA-DENVER-TITAN-TITAN MASTER-VIENNA	HSS
FP25	80x5x16,30	42,3	0,15	LINCE CA-3	HSS
FP41	80x8x16	50	1,2	CODE - ADAPTER DAKOTA EXTRA-SARATOGA-TITAN-TITAN MASTER-VIENNA	HSS
FP42	80x8x16	45	0,85	CODE - ADAPTER DAKOTA EXTRA-SARATOGA-TITAN-TITAN MASTER-VIENNA	HSS
FP43	80x8x16	45	1,55	CODE - ADAPTER DAKOTA EXTRA-SARATOGA-TITAN-TITAN MASTER-VIENNA	HSS
FP44	80x8x16	52,5	0,15	CODE - ADAPTER DAKOTA EXTRA-SARATOGA-TITAN-TITAN MASTER-VIENNA	HSS
FP45	80x8x16	45	1	CODE - ADAPTER DAKOTA EXTRA-SARATOGA-TITAN-TITAN MASTER-VIENNA	HSS
FP49	80x8x16	45	0,4	CODE - ADAPTER DAKOTA EXTRA-SARATOGA-TITAN-TITAN MASTER-VIENNA	HSS
FP50	80x8x16	50	0,4	CODE - ADAPTER DAKOTA EXTRA-SARATOGA-TITAN-TITAN MASTER-VIENNA	HSS

CODE	A	B	C	D	E	PARA-FOR	MAT
F1	90	0,8		45	6	CAPRI-COLUMBIA-DAKAR-DAKKI-DAYTONA-XCODE	
F1A	90	0,8		45	8	CAPRI-COLUMBIA-DAKAR-DAKKI-DAYTONA-XCODE	HSS
F1W	90	0,8		45	6	CAPRI-COLUMBIA-DAKAR-DAKKI-DAYTONA-XCODE	W
F3			1,5	45	6	CAPRI-COLUMBIA-DAKAR-DAKKI-DAYTONA-XCODE	HSS
F3W			1,5	45	6	CAPRI-COLUMBIA-DAKAR-DAKKI-DAYTONA-XCODE	W
F5W	90	0,9		45	6	CAPRI-COLUMBIA-DAKAR-DAKKI-DAYTONA-XCODE	HSS
F5W	90	0,9		45	6	CAPRI-COLUMBIA-DAKAR-DAKKI-DAYTONA-XCODE	W
F6	106	1		45	6	CAPRI-COLUMBIA-DAKAR-DAKKI-DAYTONA-XCODE	HSS
F7	70	0,8		45	6	CAPRI-COLUMBIA-DAKAR-DAKKI-DAYTONA-XCODE	HSS
F8			4	45	6	CAPRI-COLUMBIA-DAKAR-DAKKI-DAYTONA-XCODE	HSS
F8W			4	45	6	CAPRI-COLUMBIA-DAKAR-DAKKI-DAYTONA-XCODE	W
F11			2,5	45	6	CAPRI-COLUMBIA-DAKAR-DAKKI-DAYTONA-XCODE	HSS
F11W			2,5	45	6	CAPRI-COLUMBIA-DAKAR-DAKKI-DAYTONA-XCODE	W
F12A	100	0,6		45	6	CAPRI-COLUMBIA-DAKAR-DAKKI-DAYTONA-XCODE	HSS
F12B	100-90	2,1-2,9		45	6	CAPRI-COLUMBIA-DAKAR-DAKKI-DAYTONA-XCODE	HSS
F14	100	1,45		45	6	CAPRI-COLUMBIA-DAKAR-DAKKI-DAYTONA-XCODE	HSS
F15 plantillas		2	5	45	6	CAPRI-COLUMBIA-DAKAR-DAKKI-DAYTONA-XCODE	HSS
F16	130	0,6		45	6	CAPRI-COLUMBIA-DAKAR-DAKKI-DAYTONA-XCODE	HSS

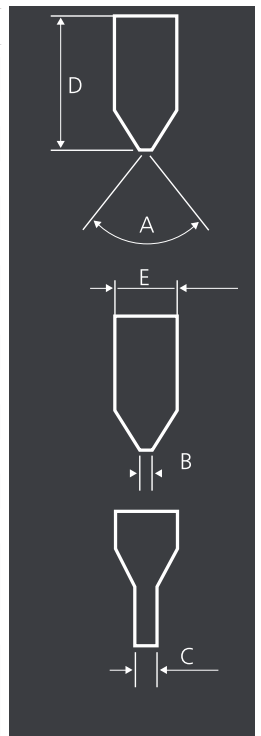
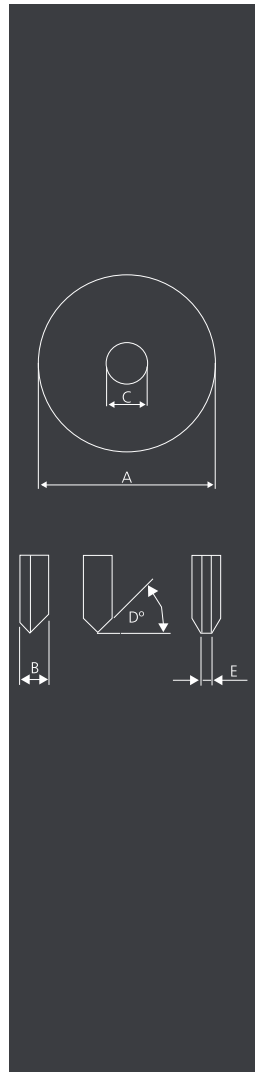

CODE	A	B	C	D	E	PARA-FOR	MAT
F17			3	45	6	CAPRI-COLUMBIA-DAKAR-DAKKI-DAYTONA-XCODE	W
F17W			3	45	6	CAPRI-COLUMBIA-DAKAR-DAKKI-DAYTONA-XCODE	W
F19	90	1,2		45	6	CAPRI-COLUMBIA-DAKAR-DAKKI-DAYTONA-XCODE	HSS
F19W	90	1,2		45	6	CAPRI-COLUMBIA-DAKAR-DAKKI-DAYTONA-XCODE	W
F21	85	0,72		45	6	CAPRI-COLUMBIA-DAKAR-DAKKI-DAYTONA-XCODE	HSS
F22			2,4	45	6	CAPRI-COLUMBIA-DAKAR-DAKKI-DAYTONA-XCODE	HSS
F23	90	0,8	3,3	45	6	CAPRI-COLUMBIA-DAKAR-DAKKI-DAYTONA-XCODE	HSS
F23W	90	0,8	3,3	45	6	CAPRI-COLUMBIA-DAKAR-DAKKI-DAYTONA-XCODE	W
F24	95	1		45	6	CAPRI-COLUMBIA-DAKAR-DAKKI-DAYTONA-XCODE	HSS
F24W	95	1		45	6	CAPRI-COLUMBIA-DAKAR-DAKKI-DAYTONA-XCODE	W
F25	95	1,1		45	6	CAPRI-COLUMBIA-DAKAR-DAKKI-DAYTONA-XCODE	HSS
F25W	95	1,1		45	6	CAPRI-COLUMBIA-DAKAR-DAKKI-DAYTONA-XCODE	W
F26	90	0,6	1,8	45	6	CAPRI-COLUMBIA-DAKAR-DAKKI-DAYTONA-XCODE	HSS
F27	90	0,7		45	6	CAPRI-COLUMBIA-DAKAR-DAKKI-DAYTONA-XCODE	HSS
F27W	90	0,7		45	6	CAPRI-COLUMBIA-DAKAR-DAKKI-DAYTONA-XCODE	W
F29W	100	0,6		45	6	XCODE	W
F30W	100	0,5		45	6	XCODE	W
F31W	90	0,6		45	6	XCODE	W
F32	90	0,6	3	45	6	CAPRI-COLUMBIA-DAKAR-DAKKI-DAYTONA-XCODE	HSS
F32W	90	0,6	3	45	6	CAPRI-COLUMBIA-DAKAR-DAKKI-DAYTONA-XCODE	W
F33			2	45	6	CAPRI-COLUMBIA-DAKAR-DAKKI-DAYTONA-XCODE	HSS
F33W			2	45	6	CAPRI-COLUMBIA-DAKAR-DAKKI-DAYTONA-XCODE	W
F34	90	1,4		45	6	CAPRI-COLUMBIA-DAKAR-DAKKI-DAYTONA-XCODE	HSS
F-35W	90	3	3	45	6	CAPRI-COLUMBIA-DAKAR-DAKKI-DAYTONA-XCODE	W
F43	90	0,7		45	6	CAPRI-COLUMBIA-DAKAR-DAKKI-DAYTONA-XCODE	HSS
FB	90- 90	2,7- 3,3		45	6	CAPRI-COLUMBIA-DAKAR-DAKKI-DAYTONA-XCODE	HSS
FC	80- 80			45	6	CAPRI-COLUMBIA-DAKAR-DAKKI-DAYTONA-XCODE	HSS
FBW	90- 90	2,7- 3,3		45	6	CAPRI-COLUMBIA-DAKAR-DAKKI-DAYTONA-XCODE	W
FCW	80- 80			45	6	CAPRI-COLUMBIA-DAKAR-DAKKI-DAYTONA-XCODE	W
F9			5,95	45	6	CHICAGO	HSS
F9W			5,95	45	6	CHICAGO	W

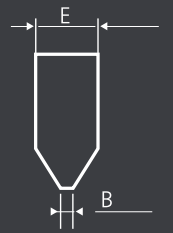
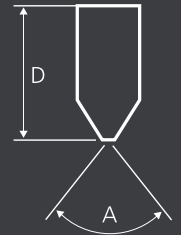

CODE	F	G	C	D	E	PARA-FOR	MAT
F18	10	1		45	6	CAPRI-COLUMBIA-DAKAR-DAKKI-DAYTONA-XCODE	HSS
F20	16	1,25		45	6	CAPRI-COLUMBIA-DAKAR-DAKKI-DAYTONA-XCODE	HSS
F36	12	2		45	6	XCODE	HSS
F37	12	1,3		45	6	XCODE	HSS

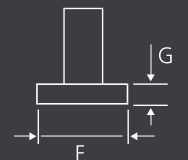

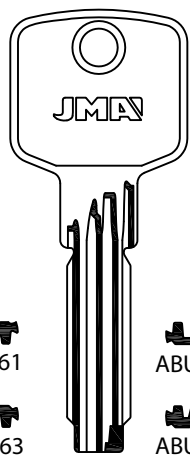

ABU-61



ABU-66



ABU-63



ABU-81

CAPRI-DAKAR- DAKAR EXPRESS

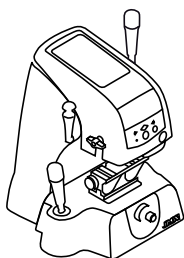

DAKKI

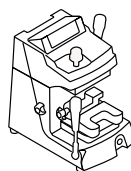

F1

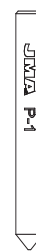

P1

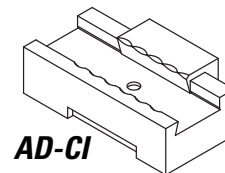

AD-CI

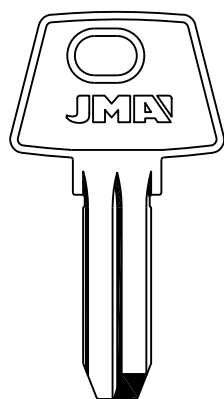

AGA-25

CAPRI-DAKAR- DAKAR EXPRESS

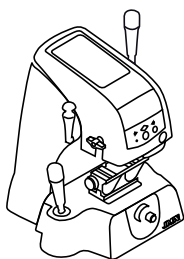

DAKKI

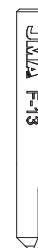
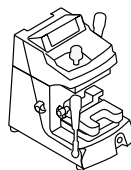

F13

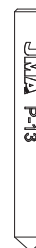

P13

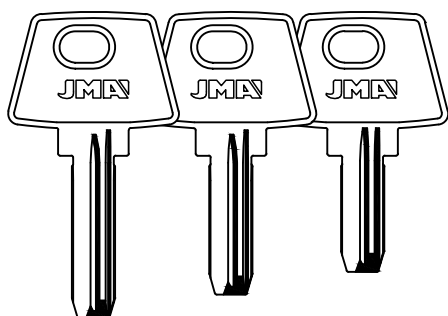

AGA-38

AGA-39

AGA-44

AGA-42

AGA-43

AGA-50

AGA-48

AGA-49

CAPRI-DAKAR- DAKAR EXPRESS

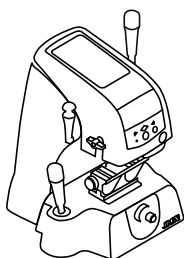

DAKKI

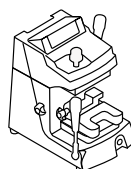

F1



P1

XCODE

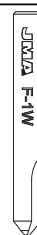
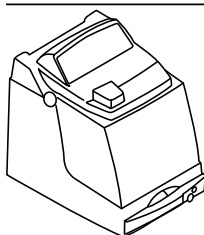

F1W

AGB

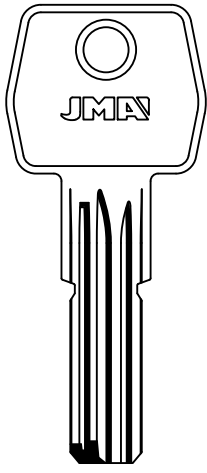

JMA
AGB-4

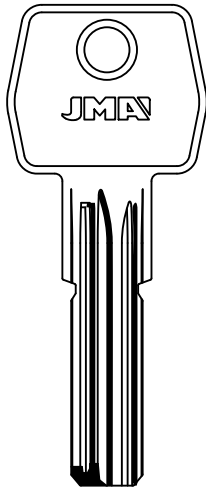

JMA
AGB-5

*CAPRI-DAKAR-
DAKAR EXPRESS*

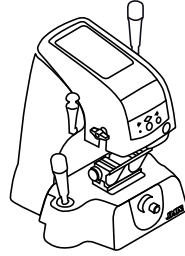

DAKKI

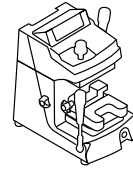

F1



P1

AMIG

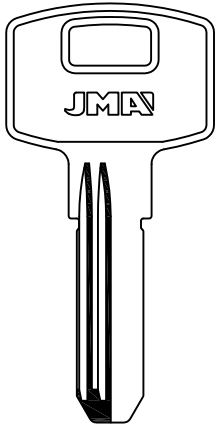

JMA
AMG-10D

*CAPRI-DAKAR-
DAKAR EXPRESS*

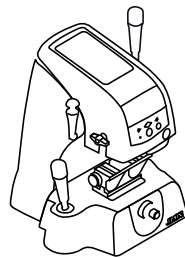

DAKKI

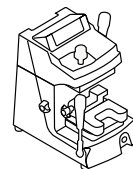

F5

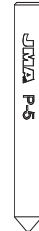

P5

APEX

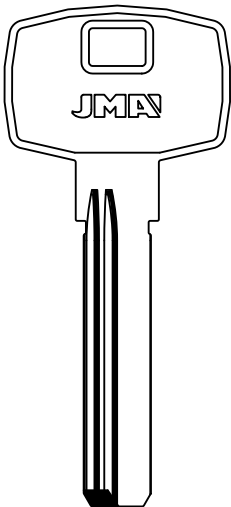

JMA
AP-4D

*CAPRI-DAKAR-
DAKAR EXPRESS*

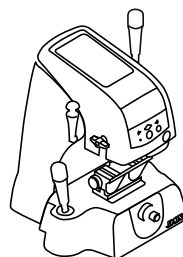

DAKKI

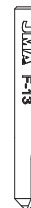
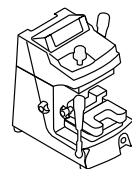

F13



P13

ASSA

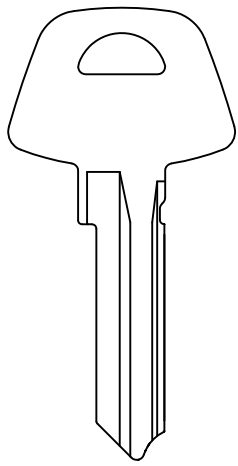

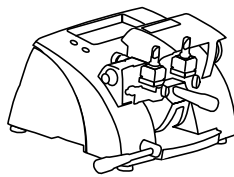

D12

VIENNA-DAKOTA EXTRA- TITAN MASTER-
ECCO/ECCO PLUS-ECCO AUTOMATIC

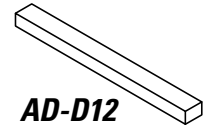
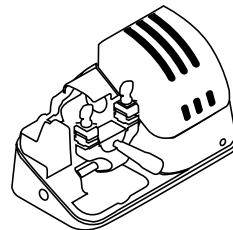
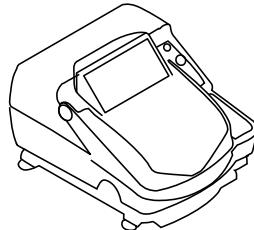

PROOCODE

ECCO-ECCO PLUS
ECCO AUTOMATIC



AD-D12

AXA

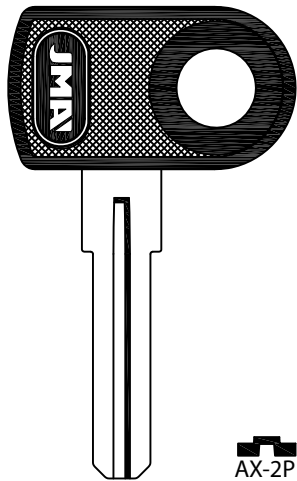

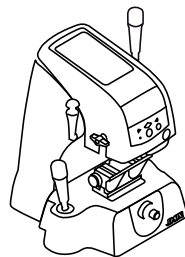

AX-2P

CAPRI-DAKAR-
DAKAR EXPRESS

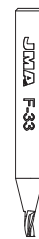
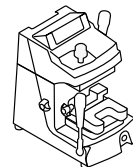

DAKKI



F33



P33

AZBE

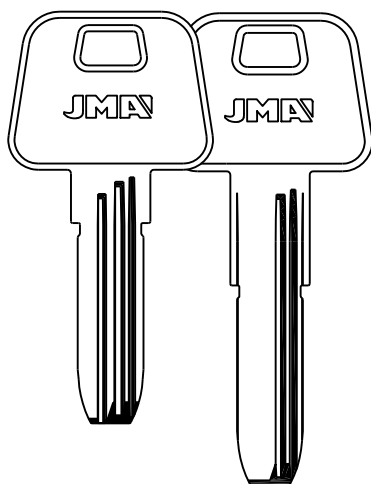



AZ-29

AZ-32

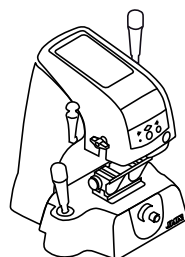
CAPRI-DAKAR-
DAKAR EXPRESS

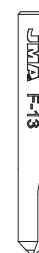
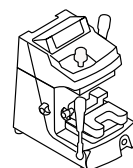

DAKKI



F13



P13

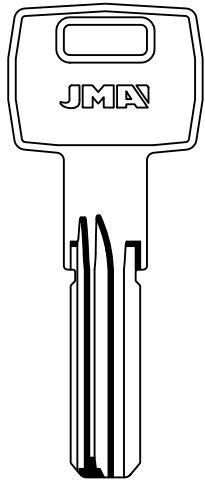

BASI
BAI-8D

*CAPRI-DAKAR-
DAKAR EXPRESS*

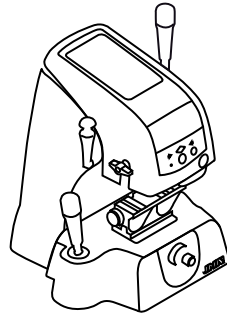

F5



P5

DAKKI

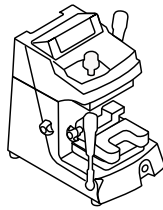

F5



P5

XCODE

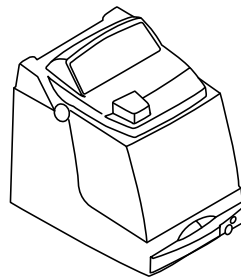

F19

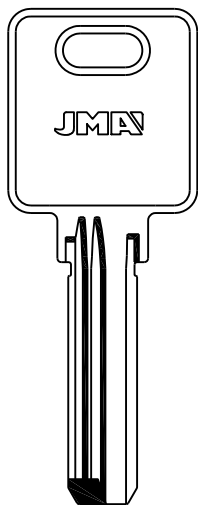

BEY
BEY-2D

*CAPRI-DAKAR-
DAKAR EXPRESS*

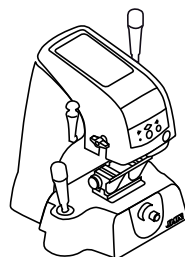

DAKKI

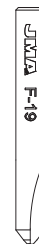
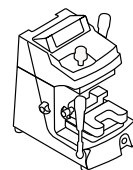

F19



P19

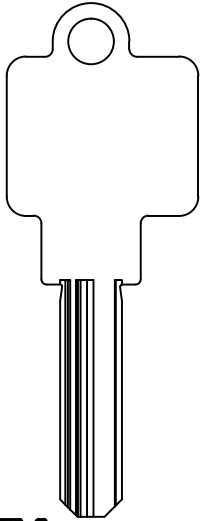

**WS 50 ORIGINAL
PROFILE NW**

*CAPRI-DAKAR-
DAKAR EXPRESS*

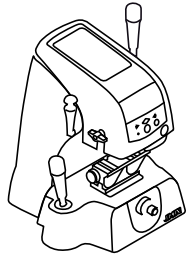

XCODE

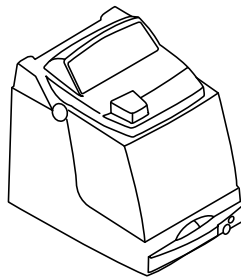

DAKKI

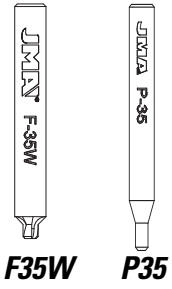
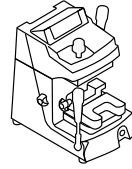

F35W P35

AD-BKS

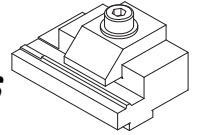

**WS 50 ORIGINAL
PROFILE RA-RK-RZ**

XCODE

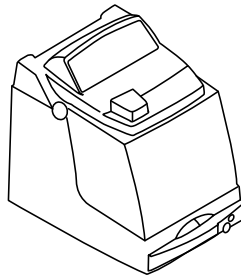

F35W

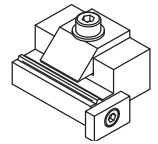

AD-X10

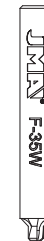

F35W

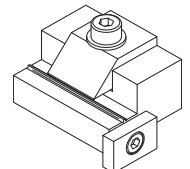

AD-X08

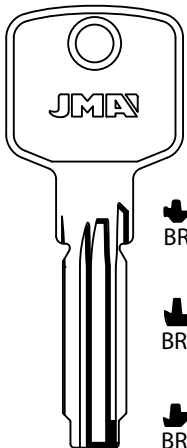

BRI-26

BRI-28

BRI-29

BRI-31

BRI-33

*CAPRI-DAKAR-
DAKAR EXPRESS*

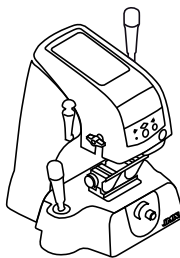

DAKKI

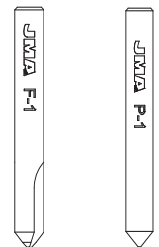
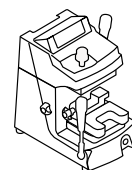

F1 P1

AD-CI

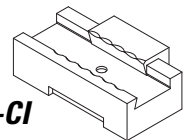

BULAT

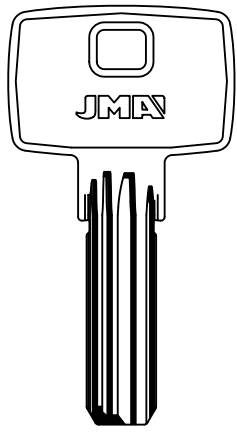

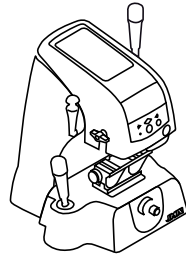

BUL-1

*CAPRI-DAKAR-
DAKAR EXPRESS*

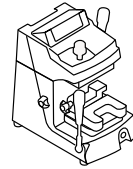

DAKKI



F1



P1

BURG

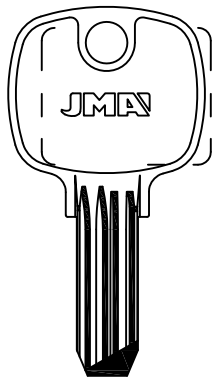

450

BUR-33

*CAPRI-DAKAR-
DAKAR EXPRESS*

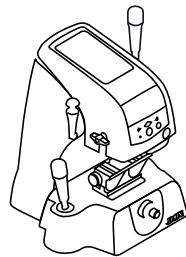

DAKKI

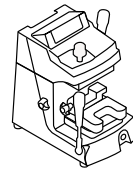

F1



P1

BYP

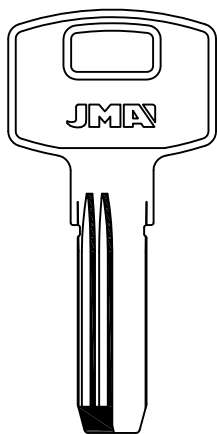

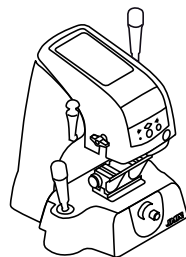

AP-5D

*CAPRI-DAKAR-
DAKAR EXPRESS*

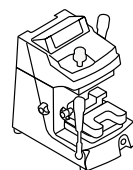

DAKKI



F19



P19

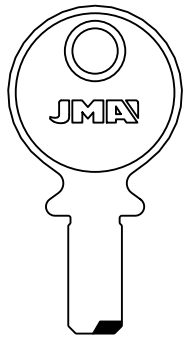

CE-114

**CAPRI-DAKAR-
DAKAR EXPRESS**

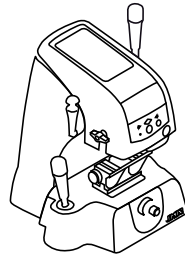

DAKKI

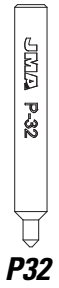
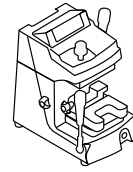

XCODE

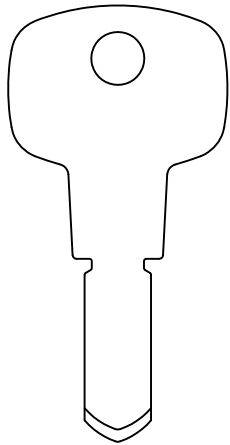
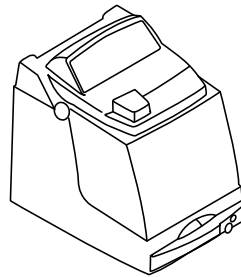

WSM

**CAPRI-DAKAR-
DAKAR EXPRESS**

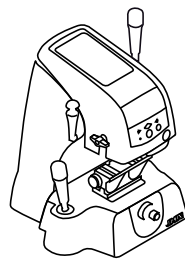

DAKKI

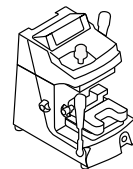

XCODE

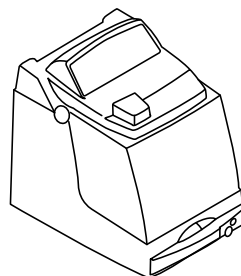

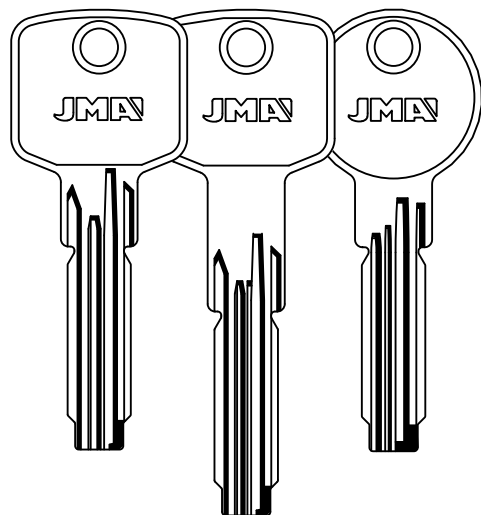

CAPRI-DAKAR-
DAKAR EXPRESS

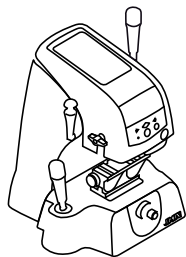

DAKKI

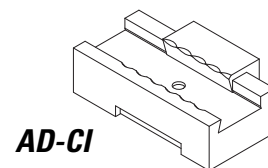
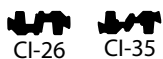
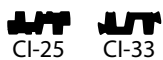
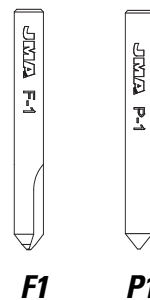
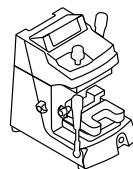

XCODE

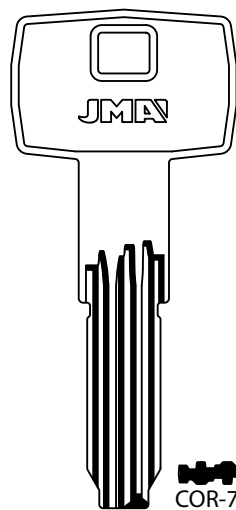
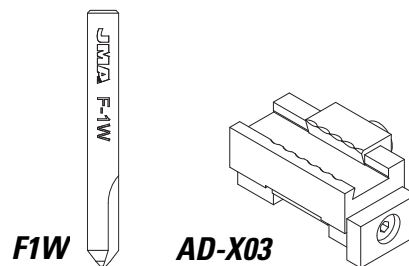
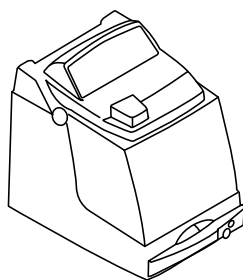

CAPRI-DAKAR-
DAKAR EXPRESS

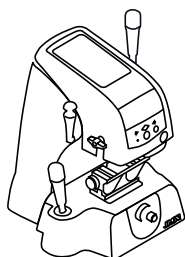

DAKKI

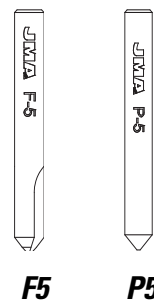
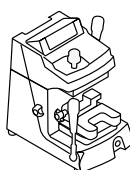

DAF

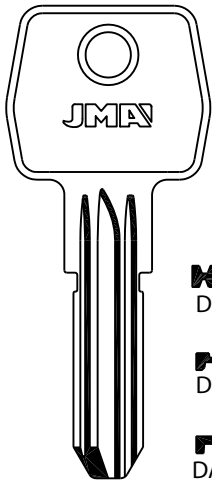

 DAF-2

 DAF-3D

 DAF-4D

CAPRI-DAKAR- DAKAR EXPRESS

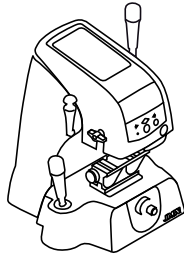

DAKKI

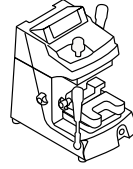

F13



P13

DEKABA

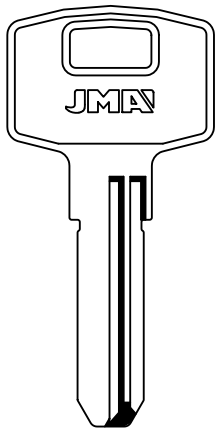

 DEK-3

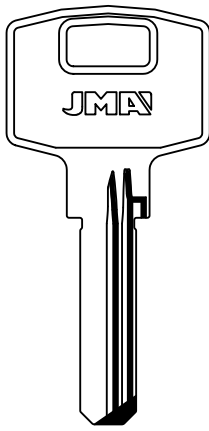

 DEK-4

 DEK-8

CAPRI-DAKAR- DAKAR EXPRESS

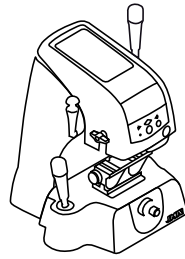

DAKKI

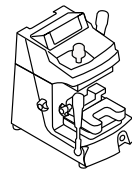

F1

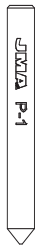

P1

DELCA

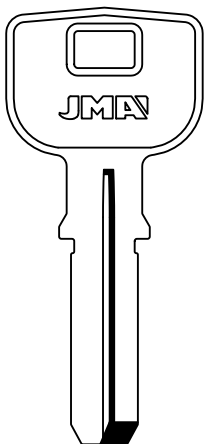

 DLC-3

CAPRI-DAKAR- DAKAR EXPRESS

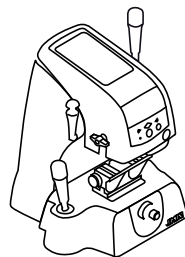

DAKKI

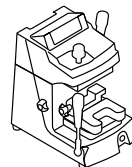

F1

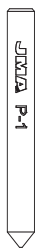

P1

DENNY

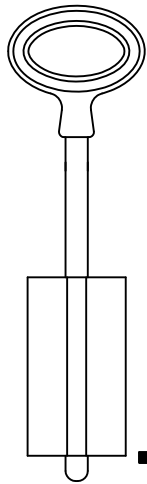

DEN-1

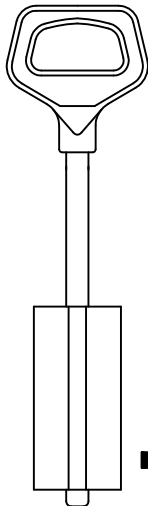

DEN-2

SENA

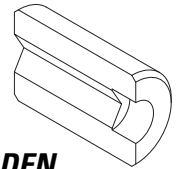
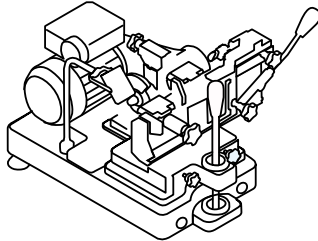

AD-DEN

DIERRE

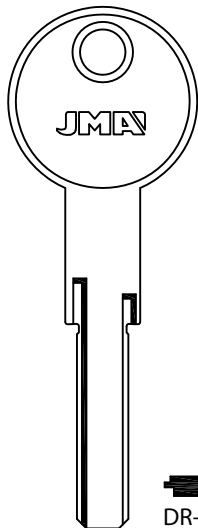

DR-1

CAPRI-DAKAR- DAKAR EXPRESS

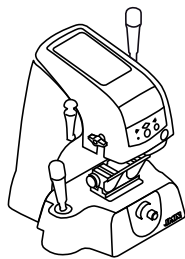

DAKKI

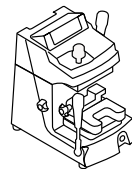

F11



P11

DOM

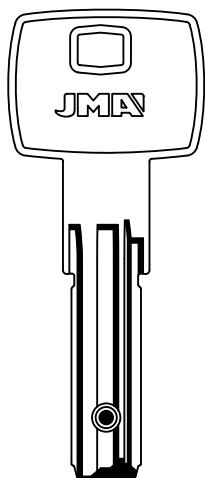

DOM-B1

CAPRI-DAKAR- DAKAR EXPRESS

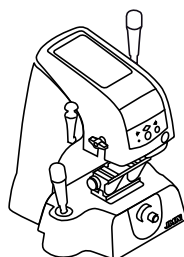

DAKKI

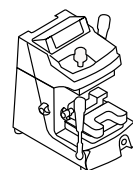

F1



P1

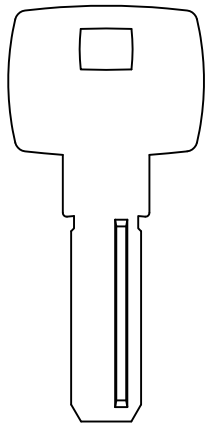

038
IX5 DAS

CAPRI-DAKAR-
DAKAR EXPRESS

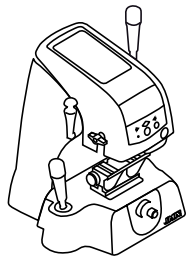

DAKKI

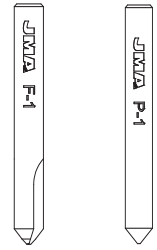
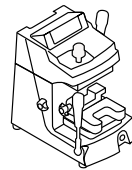

F1 **P1**

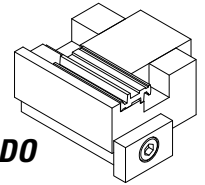

AD-DO

XCODE (Password Protected-DOM authorization)

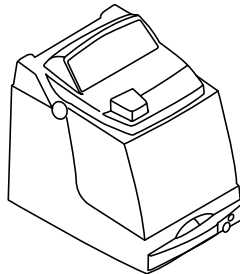

F1W

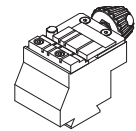

M4

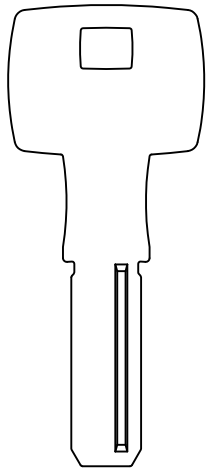

138
IX DAS

CAPRI-DAKAR-
DAKAR EXPRESS

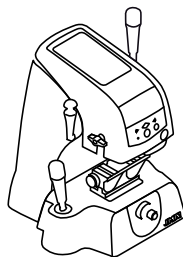

DAKKI

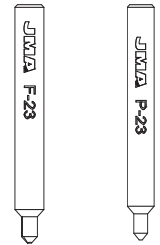
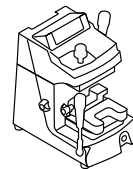

F23 **P23**

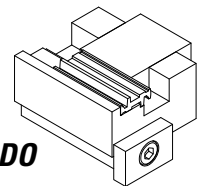

AD-DO

XCODE (Password Protected-DOM authorization)

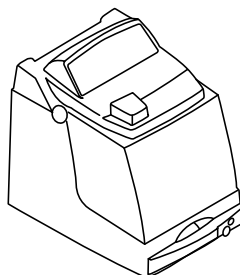

F23W

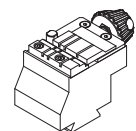

M4

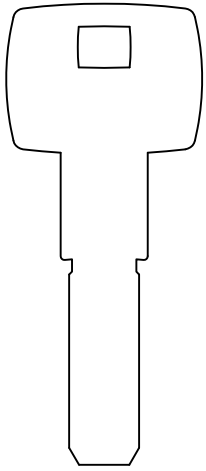

102/121
IX6 KG

*CAPRI-DAKAR-
DAKAR EXPRESS*

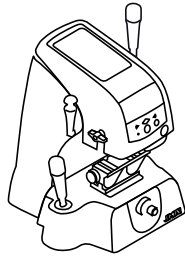

DAKKI

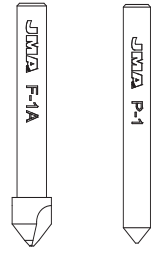
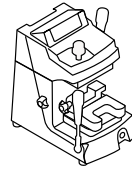

F1A P1

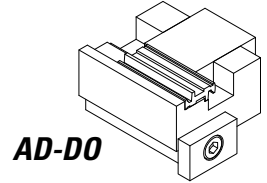

AD-DO

XCODE (Password Protected-DOM authorization)

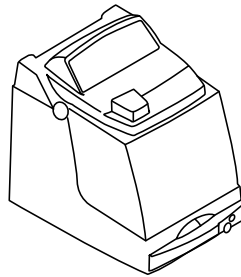

F1A

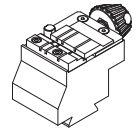

M4

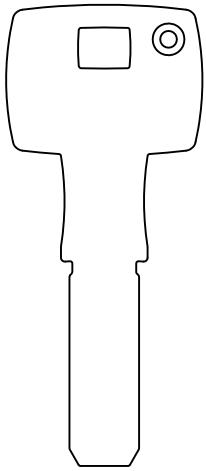

132 / 232
IX6 SR

*CAPRI-DAKAR-
DAKAR EXPRESS*

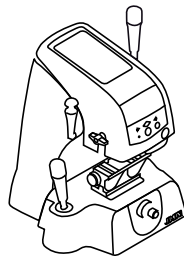

DAKKI

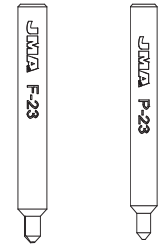
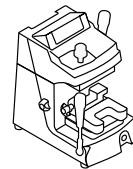

F23 P23

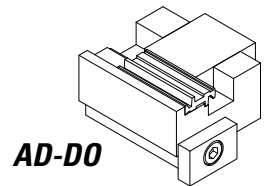

AD-DO

XCODE (Password Protected-DOM authorization)

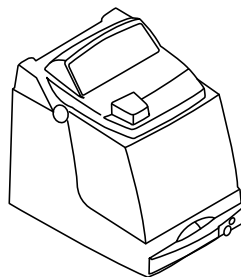

F23W

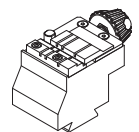

M4

DOM

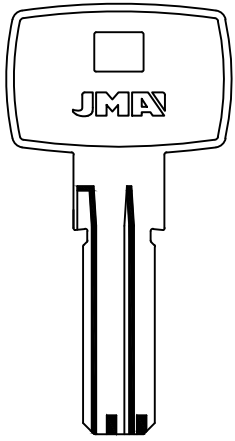

 DOM-56D

 DOM-63D

CAPRI-DAKAR-
DAKAR EXPRESS

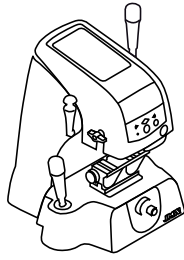

DAKKI

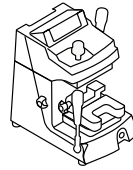

F1

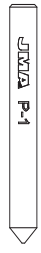

P1

XCODE (Password Protected-DOM authorization)

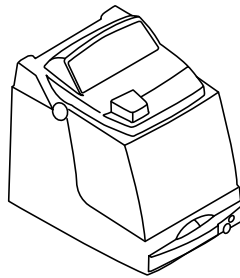

F1W



DOM-DORMA

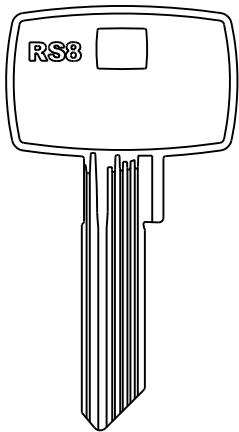

 RS8 ORIGINAL

VIENNA-DAKOTA EXTRA- TITAN MASTER-
ECCO/ECCO PLUS-ECCO AUTOMATIC

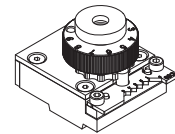
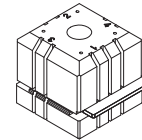
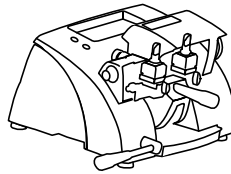

CODE CLAMP DO-716

SARATOGA

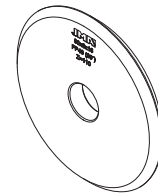
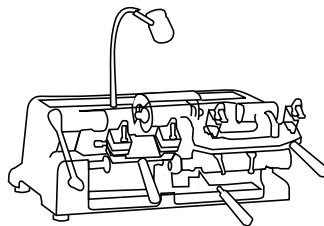

FP49

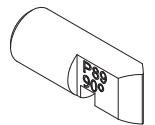

P89

PROCEDURE

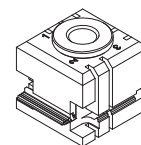
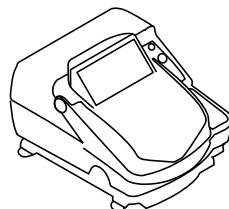

MP2

EUROLOCKS

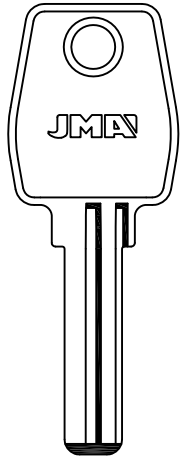

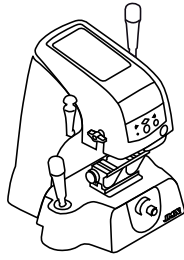

EU-12

*CAPRI-DAKAR-
DAKAR EXPRESS*

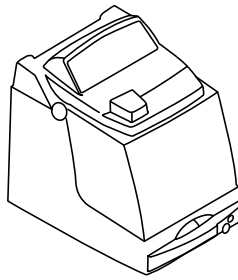

XCODE



DAKKI

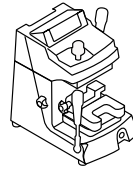

F3



P3



F33W

FAC

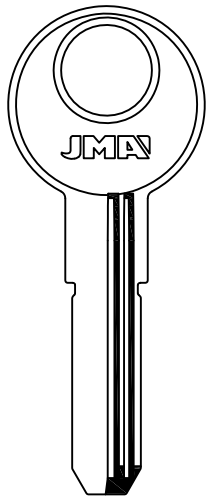

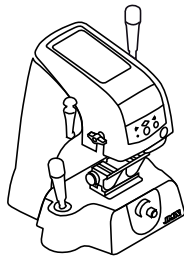

FAC-24

*CAPRI-DAKAR-
DAKAR EXPRESS*

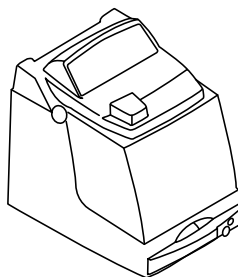

XCODE



DAKKI

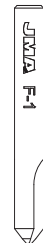
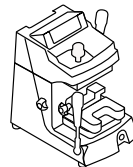

F1



P1



F1W

FAYN

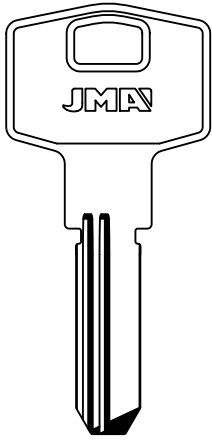

FAY-1D

CAPRI-DAKAR- DAKAR EXPRESS

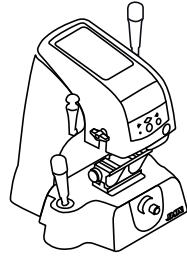

DAKKI

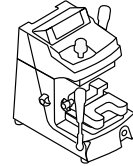

F5

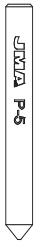

P5

FICHET

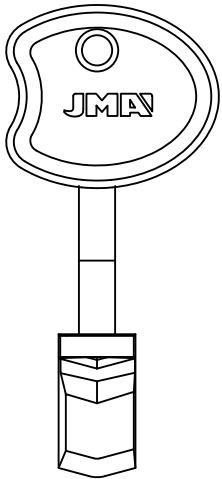

FIC-18

CAPRI-DAKAR- DAKAR EXPRESS

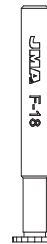
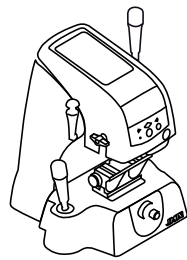

F18



P18

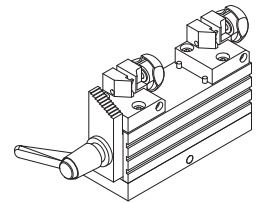

FI 18-DA

FTH

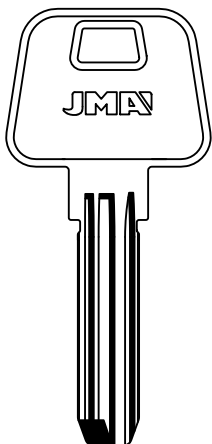

FTH-23

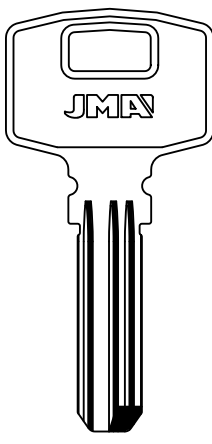

FTH-24

CAPRI-DAKAR- DAKAR EXPRESS

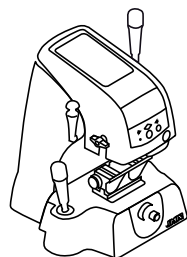

DAKKI

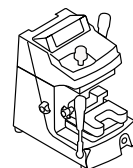

F5



P5

FTH

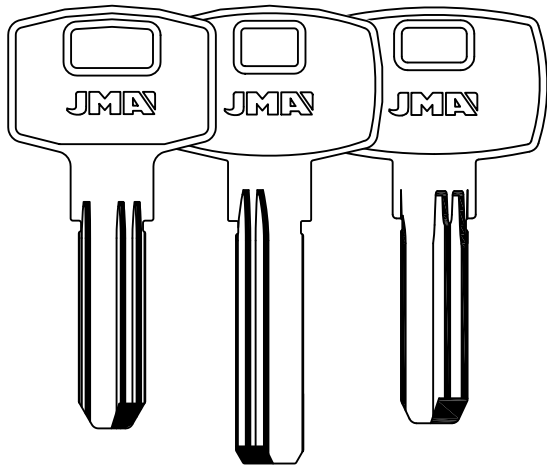

*CAPRI-DAKAR-
DAKAR EXPRESS*

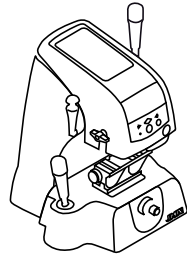

DAKKI

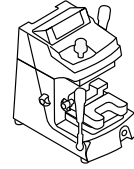

F5

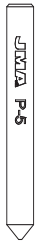

P5



FTH-25



FTH-26D



FTH-29



FTH-30

GERDA

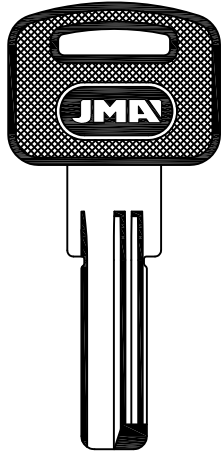

GDA-1P

*CAPRI-DAKAR-
DAKAR EXPRESS*

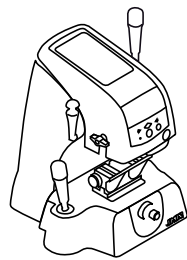

DAKKI

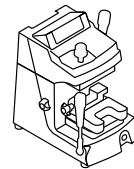

F1



P1

HUF

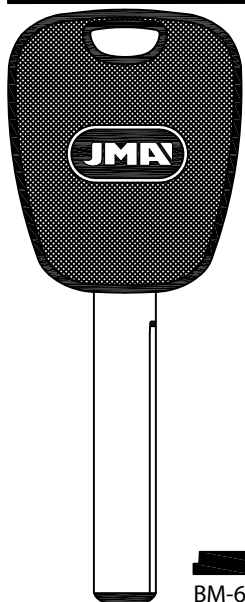

BM-6P

*CAPRI-DAKAR-
DAKAR EXPRESS*

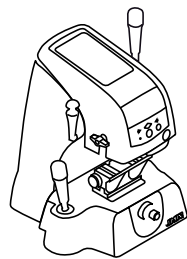

DAKKI

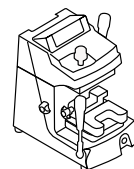

F11



P11

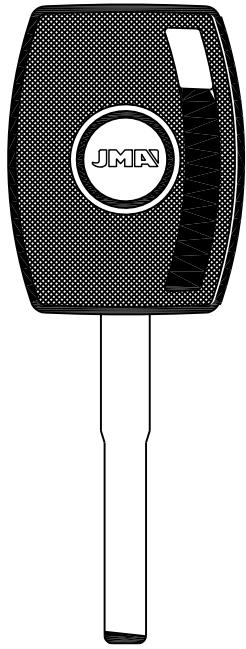

FO-24P

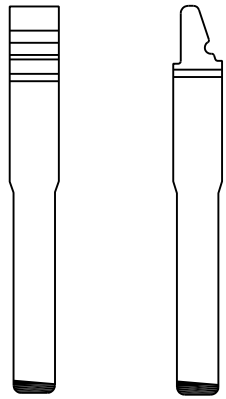

FO-24C1

FO-24C2

CAPRI-DAKAR- DAKAR EXPRESS

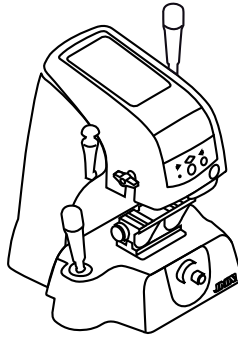

F11



P11

DAKKI

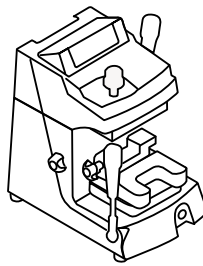

F11

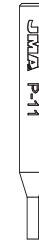

P11

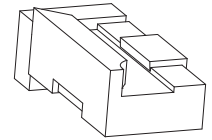

AD-F024

XCODE

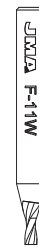
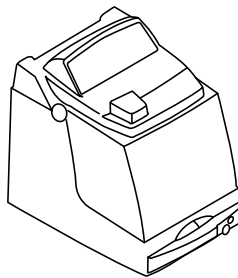

F11W

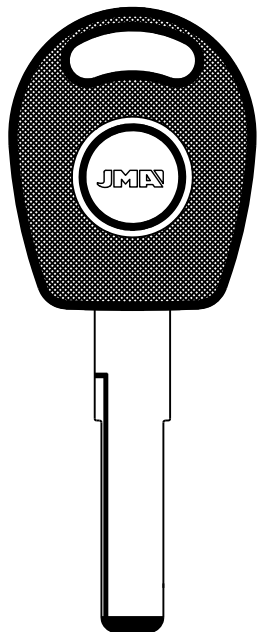

HU-HAAP1

*CAPRI-DAKAR-
DAKAR EXPRESS*

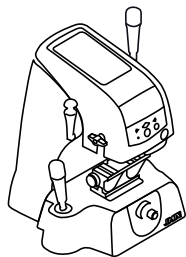

DAKKI

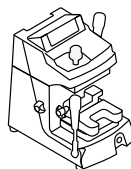

F11

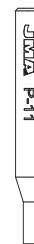

P11

XCODE

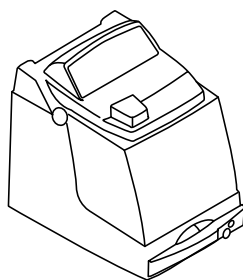

F-17W

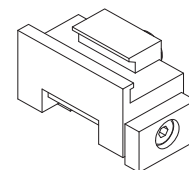

AD-AU

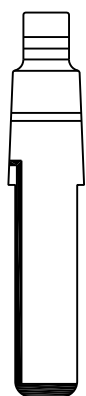

HU-HAAC1

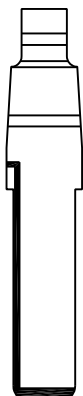

HU-HAAC2

HU-NAAC2

*CAPRI-DAKAR-
DAKAR EXPRESS*

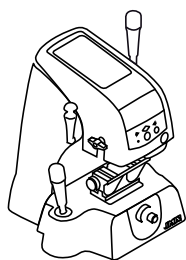

DAKKI

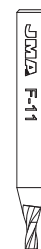
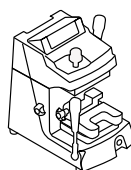

F11

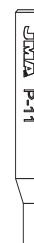

P11

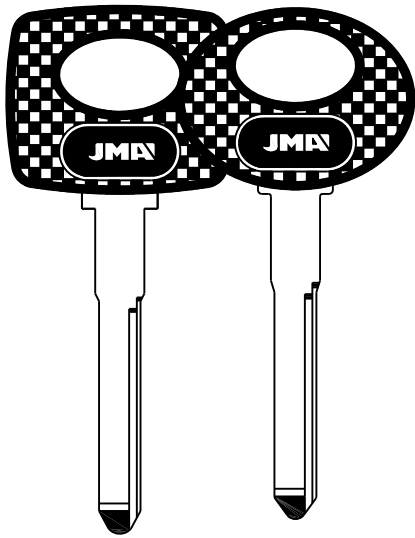

CAPRI-DAKAR- DAKAR EXPRESS

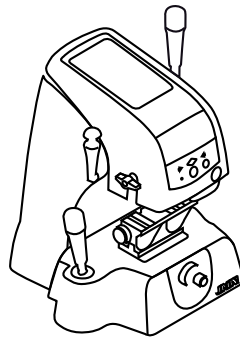

ME-4P

ME-5P



F11



P11

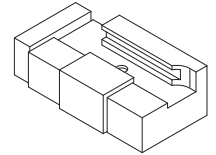

AD-MM

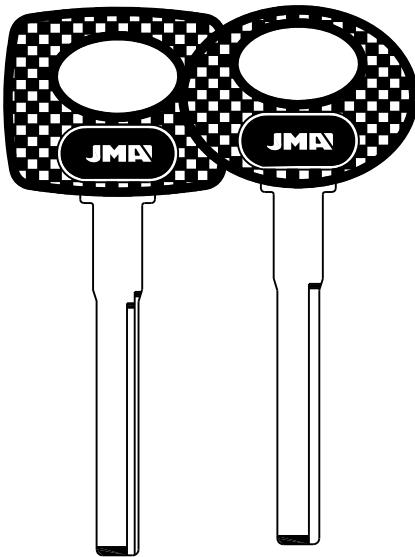

DAKKI

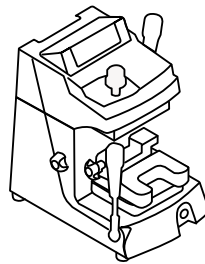

F11

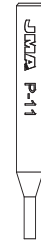

P11

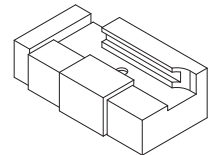

AD-MM

ME-10P

ME-12P

ME-11P

XCODE

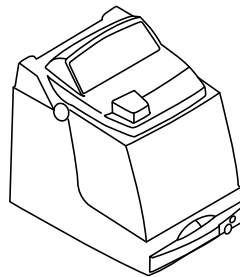

F11W

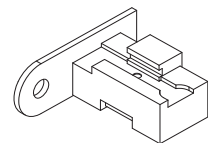

AD-X04

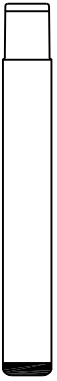

OP-11C1

*CAPRI-DAKAR-
DAKAR EXPRESS*

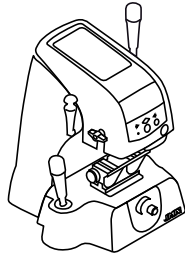

DAKKI

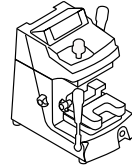

F11

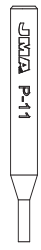

P11

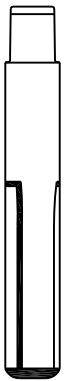

OP-WHC1

*CAPRI-DAKAR-
DAKAR EXPRESS*

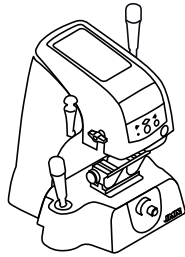

DAKKI

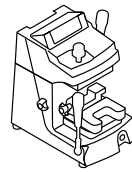

F11

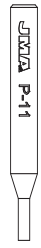

P11

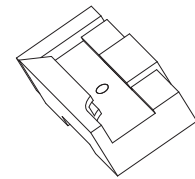

AD-OP

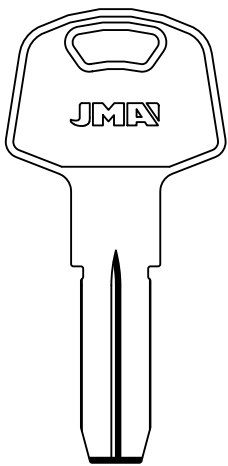

IF-4

*CAPRI-DAKAR-
DAKAR EXPRESS*

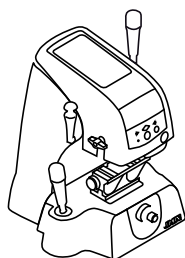

DAKKI

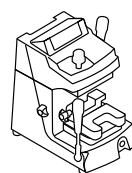

F1

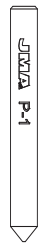

P1

IFAM

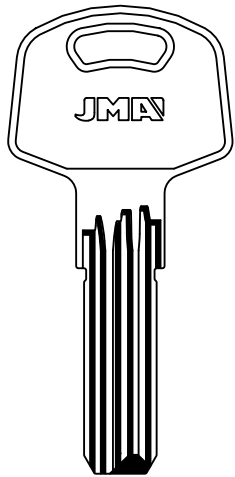

IF-6

CAPRI-DAKAR- DAKAR EXPRESS

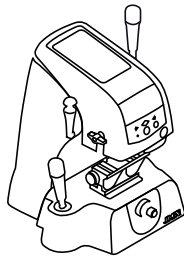

DAKKI

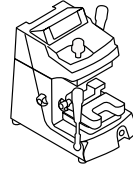

F19

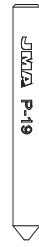

P19

ISEO

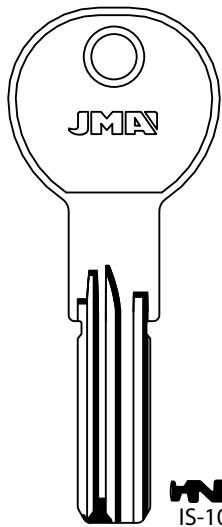

IS-10

CAPRI-DAKAR- DAKAR EXPRESS

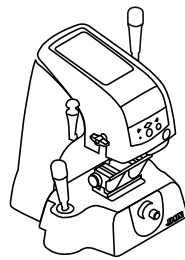

DAKKI

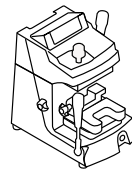

F1

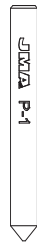

P1

KALE

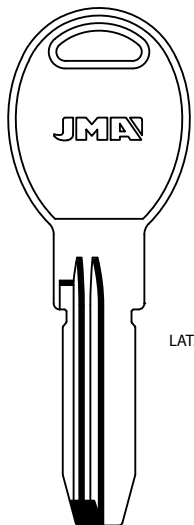

LAT.

CAPRI-DAKAR- DAKAR EXPRESS

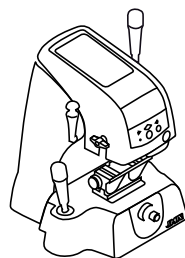

DAKKI

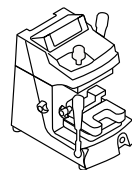

F1

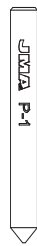

P1

KAE-11D

JMA®

Copyright by Alejandro Altuna S.A. 2012

ATENCIÓN: Concerniente a las marcas y denominaciones comerciales ver nota en índice.
ATTENTION: Concerning the marks and commercial denominations see note in index.
ATTENTION: Concernant les marques et dénominations commerciales voir la note dans l'index.
ACHTUNG: Beziehen auf die marke und handelsname sehen sie die notiz im index.

KESO

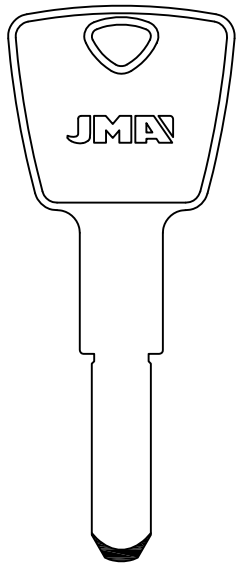

KE-5

CAPRI-DAKAR-
DAKAR EXPRESS

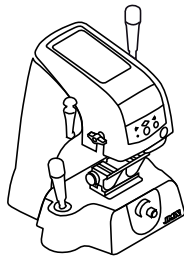

DAKKI

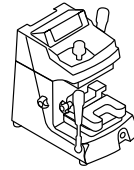

F1



P1

XCODE

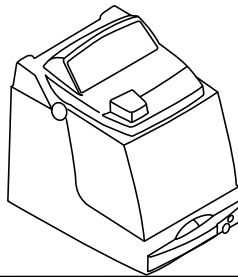

F1W

LINCE

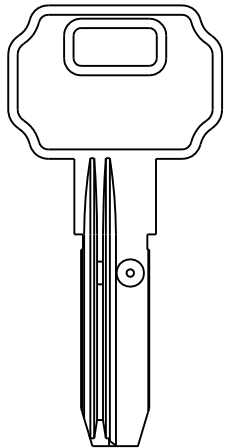

XCODE

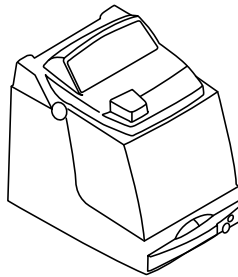

F5W

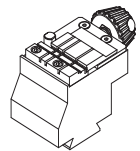

M7



C2/C3/C4
ORIGINAL

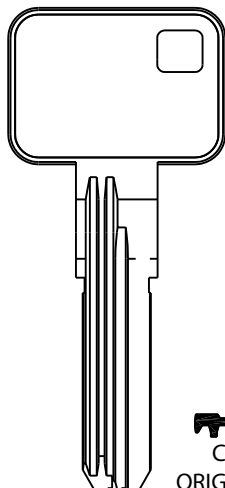

XCODE

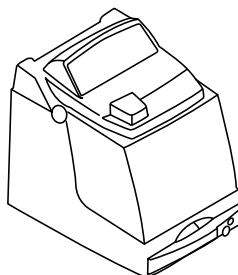

F28W

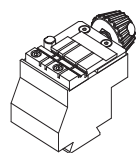

M7



C5
ORIGINAL

MASTER LOCK

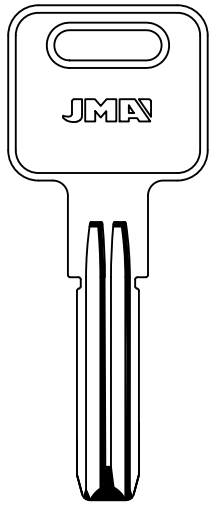

MASL-1

*CAPRI-DAKAR-
DAKAR EXPRESS*

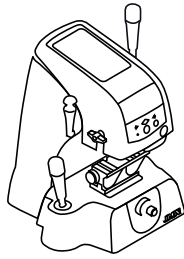

DAKKI

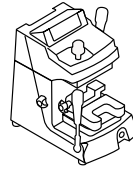

F1

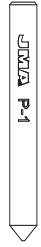

P1

MCM

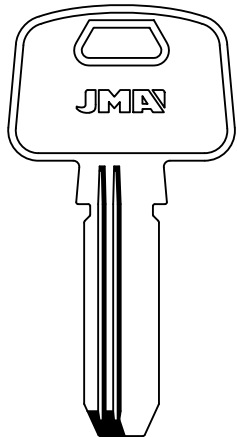

MCM-10

*CAPRI-DAKAR-
DAKAR EXPRESS*

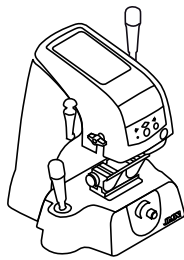

DAKKI



F13



P13

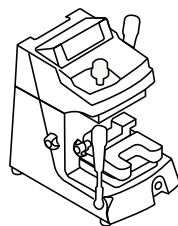

XCODE



F13



P13

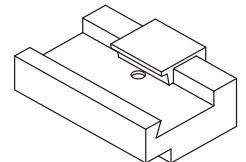

AD-MCM

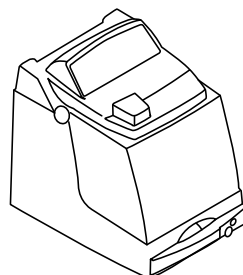

F13W

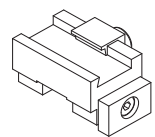

AD-X05

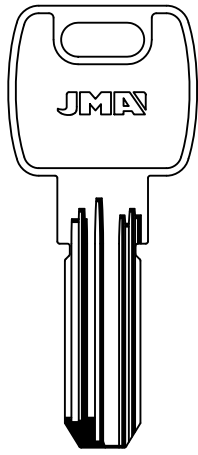

MCM-16
MCM-21D

*CAPRI-DAKAR-
DAKAR EXPRESS*

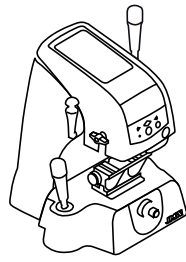

DAKKI

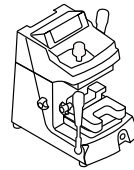

F13



P13

XCODE

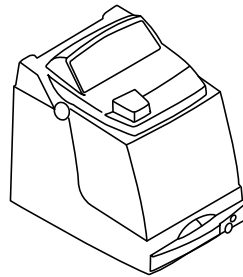

F13W

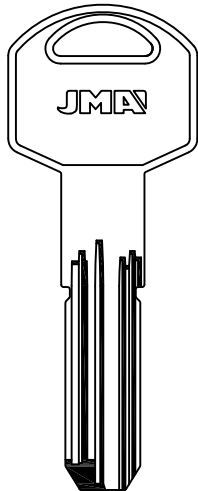

MCM-27

*CAPRI-DAKAR-
DAKAR EXPRESS*

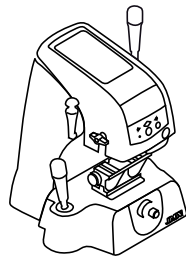

DAKKI

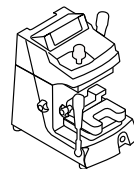

F13



P13

XCODE

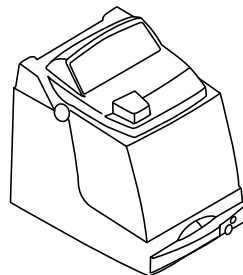

F13W

MSM

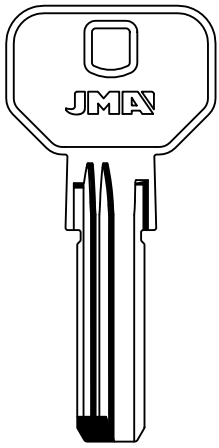

MSM-1

CAPRI-DAKAR- DAKAR EXPRESS

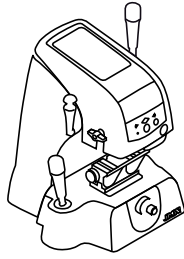

DAKKI

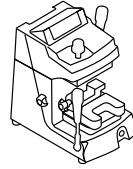

F19



P19

MUL.T.LOCK

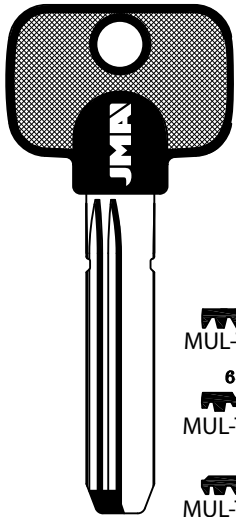

MUL-T3.P1

64
MUL-T8.P1

MUL-T9.P1

JUNIOR
MUL-T11.P1

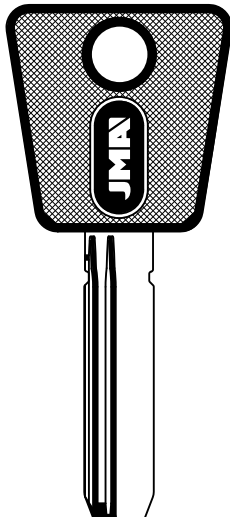

MUL-T10.P

CAPRI-DAKAR- DAKAR EXPRESS

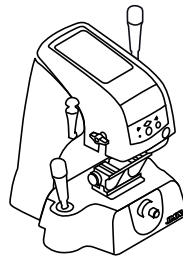

XCODE

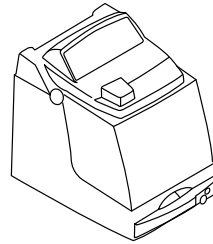

DAKKI

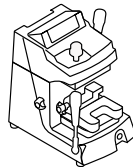

F12A P12A



F12B P12B



PFAFFENHAIN

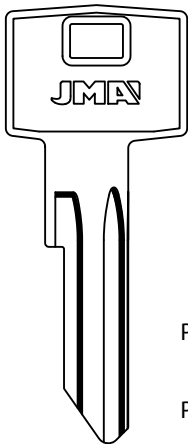

PFA-4

A21
PFA-10D

A22
PFA-11D

A23
PFA-12D

EA
PFA-13D

EB
PFA-14D

EH
PFA-15D

EN
PFA-16D

RF
PFA-17D

RG
PFA-18D

CAPRI-DAKAR- DAKAR EXPRESS

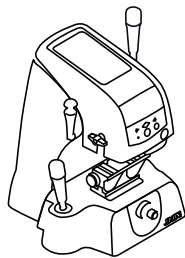

DAKKI

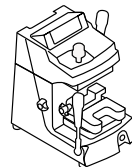

F34



P34

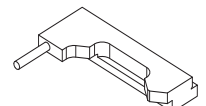

AD-PFA
(Puntos laterales, latera dimples)

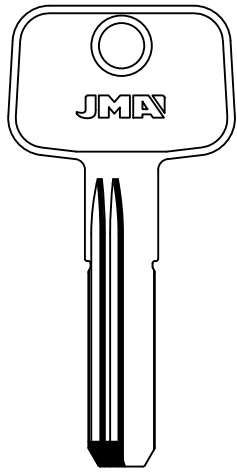

JMA
PTN-1D

CAPRI-DAKAR-
DAKAR EXPRESS

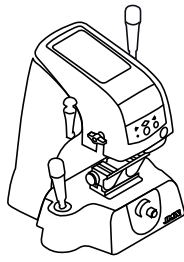

DAKKI

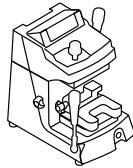

F5



P5



F19

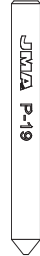

P19

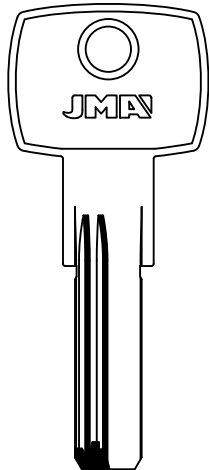

P04.....
1-2-3-4-5-6
JMA
PTN-2D

CAPRI-DAKAR-
DAKAR EXPRESS

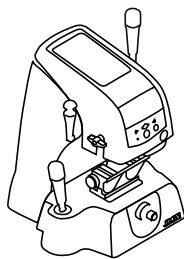

DAKKI

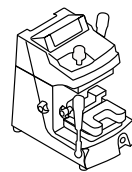

F19

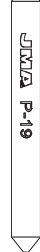

P19

XCODE

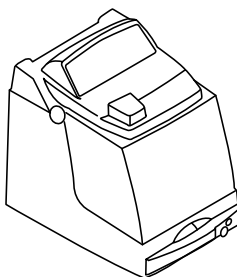

F19

ROSSETTI

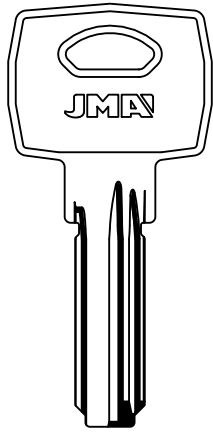

ROSE-1

*CAPRI-DAKAR-
DAKAR EXPRESS*

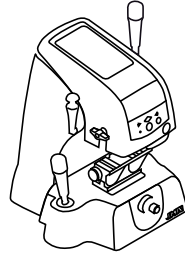

DAKKI

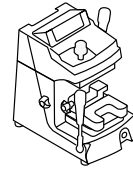

F1

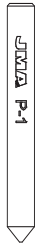

P1

SECUREMME

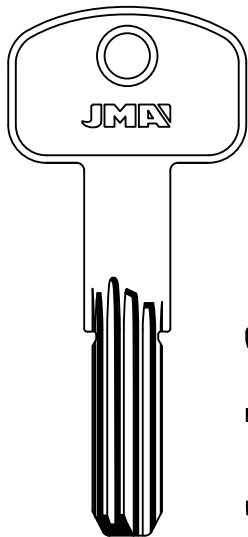

KP2
SEC-1
K1
SEC-2
SEC-3

*CAPRI-DAKAR-
DAKAR EXPRESS*

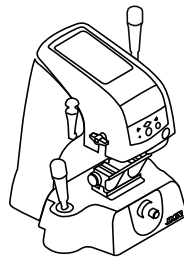

DAKKI

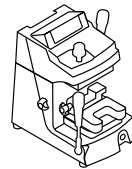

F19



P19

SERRALLER

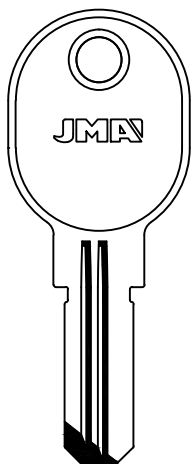

SER-3D

*CAPRI-DAKAR-
DAKAR EXPRESS*

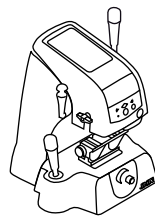

XCODE

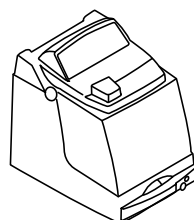

DAKKI

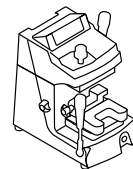

F1



P1



F1W

JMA®

Copyright by Alejandro Altuna S.A. 2012

ATENCIÓN: Concerniente a las marcas y denominaciones comerciales ver nota en índice.
ATTENTION: Concerning the marks and commercial denominations see note in index.
ATTENTION: Concernant les marques et dénominations commerciales voir la note dans l'index.
ACHTUNG: Beziehen auf die marke und handelsname sehen sie die notiz im index.

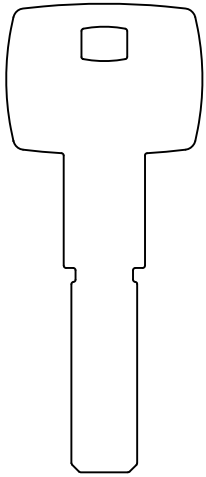

ST15

XCODE

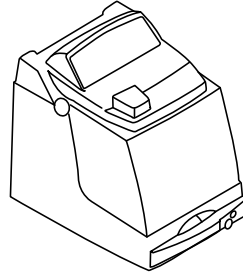

F23W

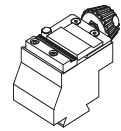

M5

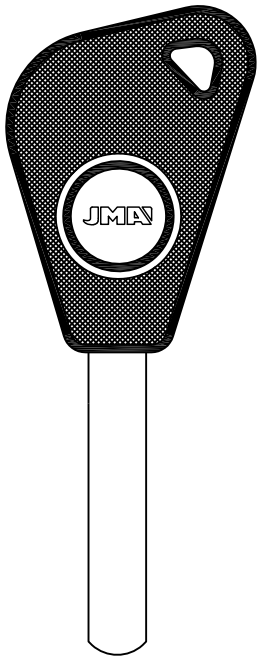

SUB-2P

*CAPRI-DAKAR-
DAKAR EXPRESS*

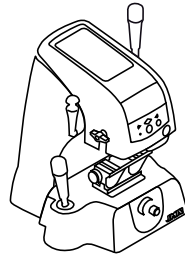

DAKKI

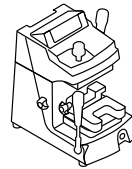

F11

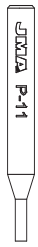

P11

XCODE

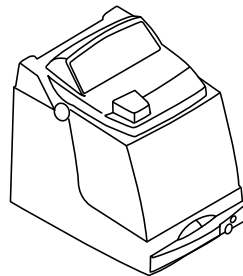

F11W

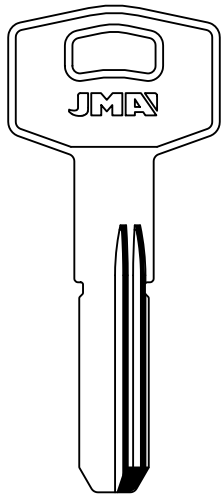

TRO-1 TRO-1D

CAPRI-DAKAR- DAKAR EXPRESS

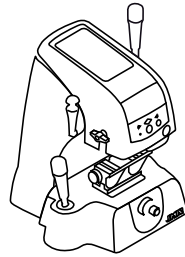

DAKKI

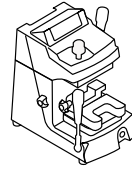

F1



P1

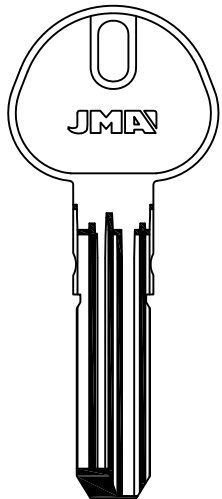

TC6
TC-1

CAPRI-DAKAR- DAKAR EXPRESS

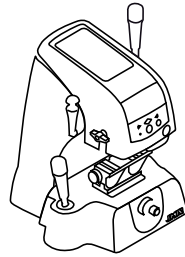

DAKKI

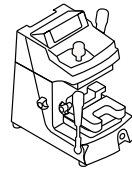

F13

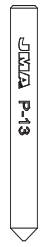

P13

XCODE

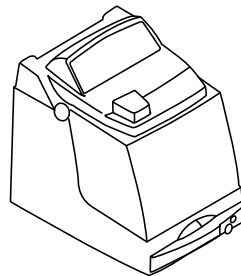

F13W

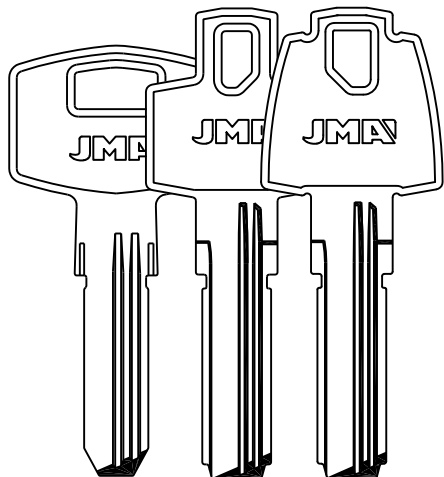

 TE-T11

 TE-T61

 TE-T62

CAPRI-DAKAR-
DAKAR EXPRESS

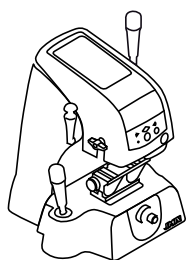

DAKKI

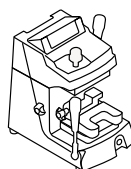

F5

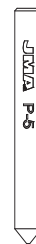

P5

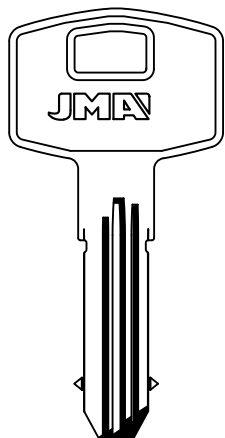

 TE-T12PLUS

CAPRI-DAKAR-
DAKAR EXPRESS

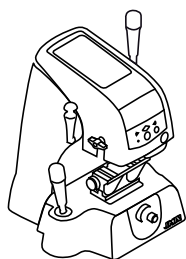

DAKKI

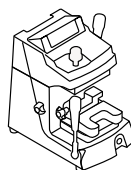

F5

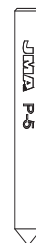

P5

AD-T12P

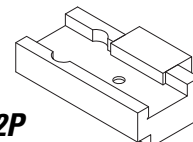

 TOYO-30P1

CAPRI-DAKAR-
DAKAR EXPRESS

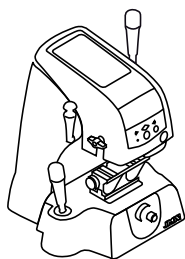

DAKKI

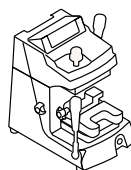

F11

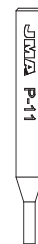

P11

TRW-SIPEA

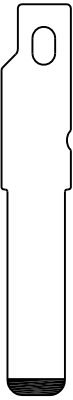

FI-16P
FI-16P1

FI-16C1

CAPRI-DAKAR-
DAKAR EXPRESS

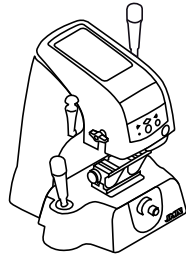

DAKKI

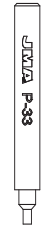
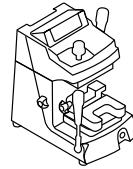

F33

P33

UNIVERSAL

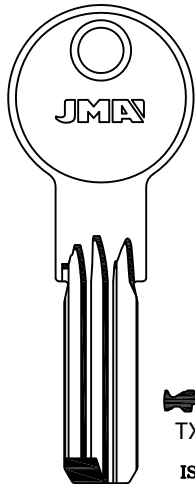

TX-2
ISEO

CAPRI-DAKAR-
DAKAR EXPRESS

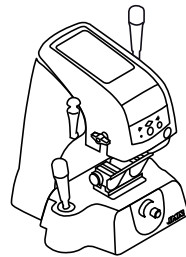

DAKKI

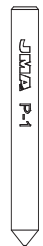
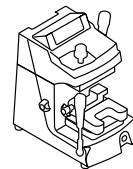

F1

P1

URBIS

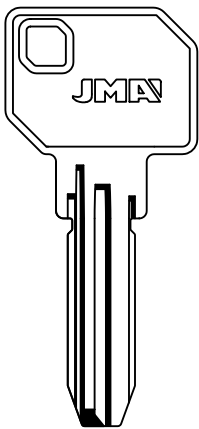

URB-3D
URB-4D

CAPRI-DAKAR-
DAKAR EXPRESS

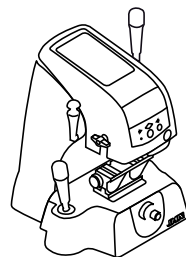

DAKKI

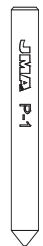
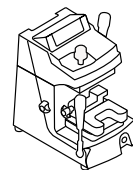

F1

P1

VACHETTE

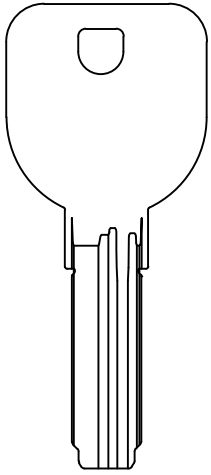

VRX
ORIGINAL

CAPRI-DAKAR- DAKAR EXPRESS

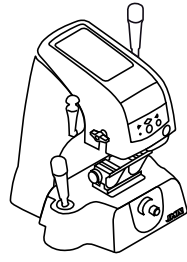

DAKKI

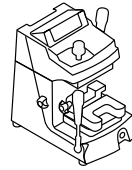

F1



P1

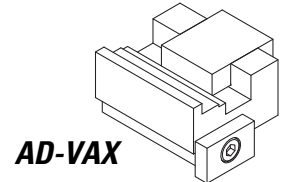

AD-VAX

VALEO

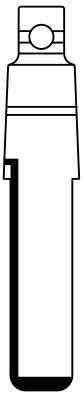

HU-HAAC3



HU-HAAC4

CAPRI-DAKAR- DAKAR EXPRESS

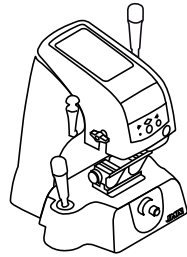

DAKKI

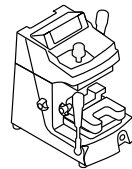

F11

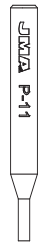

P11

XCODE

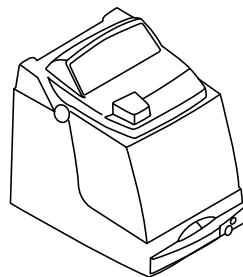

F17W

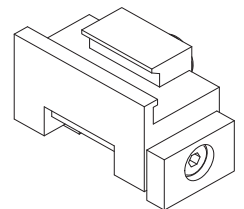

AD-AU



PEU-1C1

*CAPRI-DAKAR-
DAKAR EXPRESS*

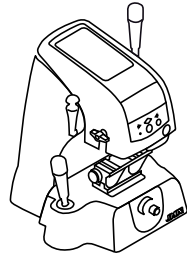

DAKKI

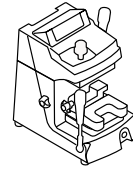

F11



P11

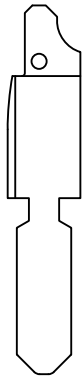

PEU-2C1

*CAPRI-DAKAR-
DAKAR EXPRESS*

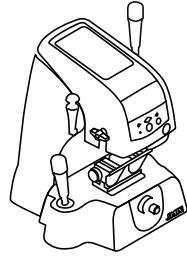

DAKKI

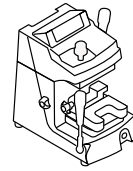

F11



P11

AD-MJ

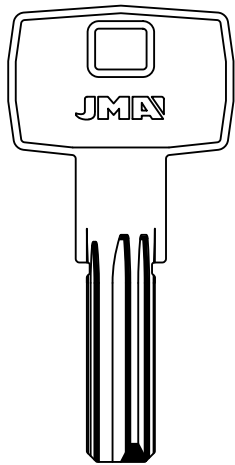
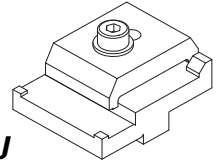

VI-14

*CAPRI-DAKAR-
DAKAR EXPRESS*

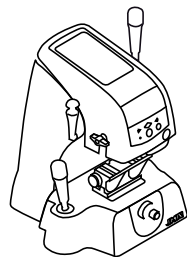

DAKKI

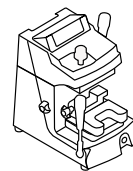

F1

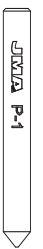

P1

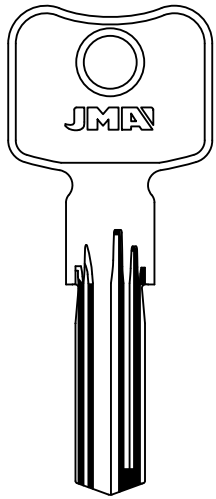

WILKA
WIL-22

*CAPRI-DAKAR-
DAKAR EXPRESS*

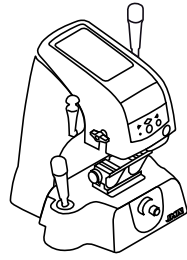

DAKKI

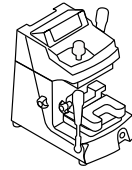

F1



P1

XCODE

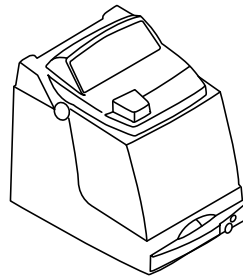

F1W

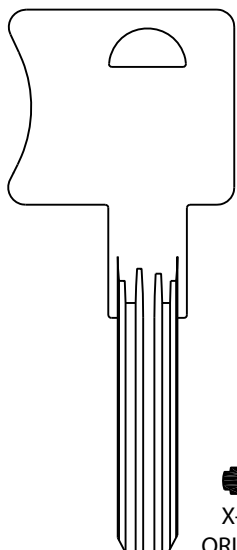

**X-TRA
ORIGINAL**

XCODE

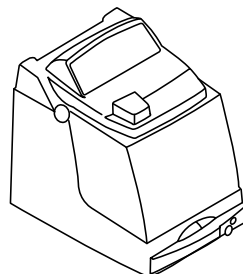

F13W

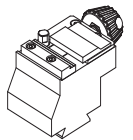

M8

AD-X09
(Puntos Laterales, lateral dimples)

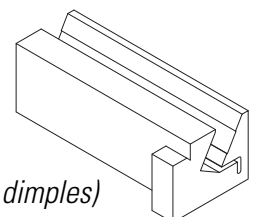

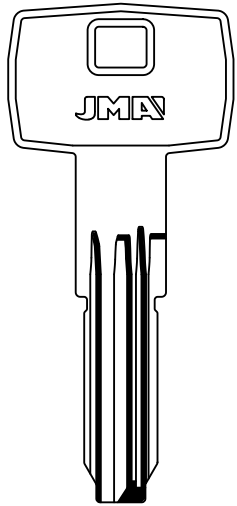

YA-81

CAPRI-DAKAR- DAKAR EXPRESS

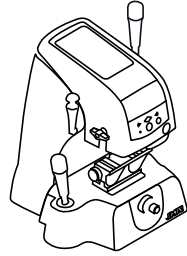

DAKKI

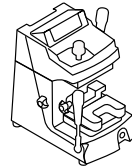

F1



P1

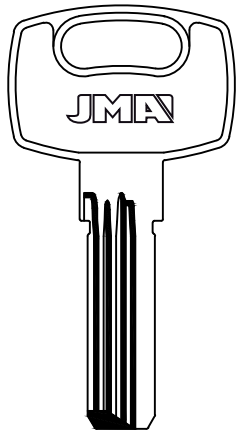

YAR-3

CAPRI-DAKAR- DAKAR EXPRESS

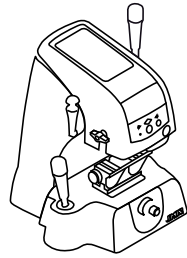

DAKKI

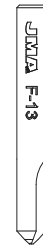
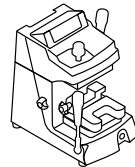

F13

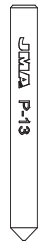

P13

XCODE

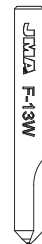
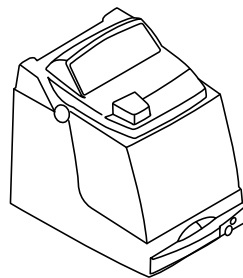

F13W

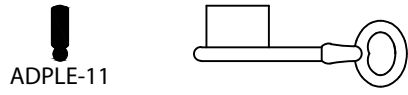

ADPLE-11

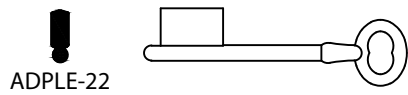

ADPLE-22

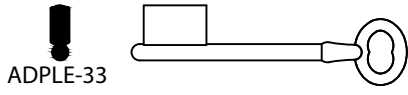

ADPLE-33

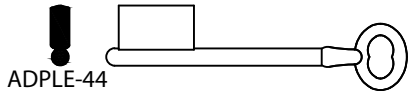

ADPLE-44

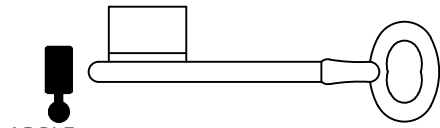

ADPLE-55

SENA

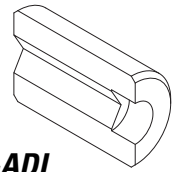
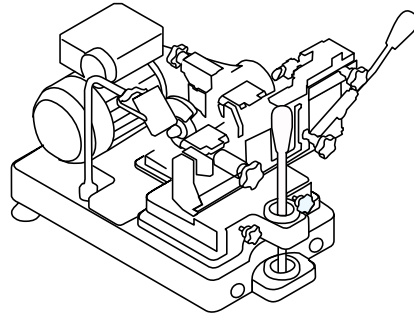

AD-ADL

JMA HEADQUARTERS
ALEJANDRO ALTUNA, S.A.

Tel +34 943 79 30 00
Fax +34 943 79 72 43
Bidekurtzeta, 6
P.O.Box - Apdo. 70
20500 Arrasate - Mondragón
Gipuzkoa - SPAIN

www.jma.es
ventas@jma.es

JMA ARGENTINA

JMA ARGENTINA S.A.
Tel +54 3461 462 422
Fax +54 3461 462 422
Av. Central Acero Argentino Oeste 678
Parque industrial COMIRSA
2900 San Nicolas (Prov. Buenos Aires)

www.jma-argentina.com
info@jma-argentina.com

JMA FRANCE

Tel +33 01 39 22 42 10
Fax +33 01 39 22 42 11
Technoparc
13, rue Edouard Jeanneret
F-78306 Poissy Cedex

www.jmafrance.fr
service.commercial@jmafrance.fr

JMA INDIA

JMA KEYS INDIA PVT. LTD
Tel +91 124 428 5450
Fax +91 124 428 5451
H-239 & H-240, Sushant Shopping Arcade
Sunshant Lok-1, Block B
122002 Gurgaon
Haryana

www.jmakeys.in
info@jmakeys.in

JMA MAROC

JMA MAROC S.A. R.L.
Tel +212 656 195 195
Fax +212 520 150 536
El Oulfa
Casablanca
Marruecos

www.jma.ma
jma@jma.ma

JMA MEXICO

LLAVES ALTUNA DE MEXICO S.A de C.V.
Tel +52 33 3777 1600
Fax +52 33 3777 1609
Av. Aviación No. 5520
Col. San Juan de Ocotlán
C.P. 45019 Zapopan, Jalisco

www.jma.com.mx
ventas@jma.com.mx

JMA POLSKA

JMA POLSKA Sp. z o.o.
Tel +48 42 835 12 80
Fax +48 42 835 12 85
91-342 Lodz ul. Zbąszynska 3

www.jmapolska.pl
biuro@jmapolska.pl

JMA PORTUGAL

ALTUNA PORTUGAL
COMERCIO DE CHAVES UNIPESSOAL, LDA.
Tel +351 219 947 470
Fax +351 219 947 471
Urbanização dos Areiros, Lote 67 C/v
2695-733 São Joao da Talha

www.jmaportugal.com
comercial@jmaportugal.com

JMA UK

SKS LTD
Tel +44 144 229 1400
Fax +44 144 286 3883
Unit 2, Canal Side
Northbridge Road
Berkhamstead
Herts HP4 1EG

www.skskeys.co.uk
sales@skskeys.co.uk

JMA URUGUAY

JMA URUGUAY S.A.
Tel +598 2908 1175
Fax +598 2900 6681
Mercedes 1420
11100 Montevideo
Uruguay

www.jma.com.uy
info@jma.com.uy

JMA USA

ALTUNA GROUP USA INC.
Tel +1 817 385 0515
Fax +1 817 385 4850
1513 Greenview Drive
75050 Grand Prairie, Texas

www.jmausa.com
info@jmausa.com